

Revision B:

• MUZ-LN25VG2 - E1, ET1,
MUZ-LN35VG2 - E1, ET1, and
MUZ-LN50VG2 - E1, ET1 have been added.

OBH767A is void.

OUTDOOR UNIT SERVICE MANUAL



**No. OBH767
REVISED EDITION-B**

Models

MUZ-LN25VG - E1, ER1, ET1

MUZ-LN35VG - E1, ER1, ET1

MUZ-LN50VG - E1, ER1, ET1

MUZ-LN60VG - E1, ER1, ET1

MUZ-LN25VG2 - E1, ET1

MUZ-LN35VG2 - E1, ET1

MUZ-LN50VG2 - E1, ET1

Indoor unit service manual
MSZ-LN•VGW/V/B/R Series (OBH766)

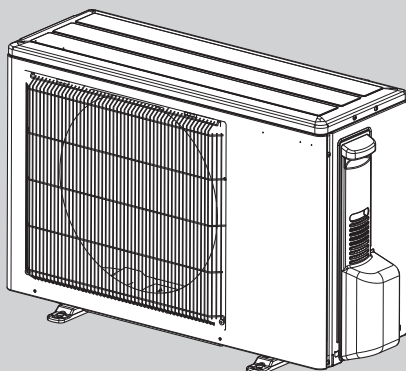

**MUZ-LN25VG
MUZ-LN35VG**

CONTENTS

1. TECHNICAL CHANGES	2
2. SERVICING PRECAUTIONS FOR UNITS USING REFRIGERANT R32	3
3. PART NAMES AND FUNCTIONS	5
4. SPECIFICATION	6
5. NOISE CRITERIA CURVES	9
6. OUTLINES AND DIMENSIONS	11
7. WIRING DIAGRAM	14
8. REFRIGERANT SYSTEM DIAGRAM	17
9. PERFORMANCE CURVES	19
10. ACTUATOR CONTROL	38
11. SERVICE FUNCTIONS	39
12. TROUBLESHOOTING	40
13. DISASSEMBLY INSTRUCTIONS	62

PARTS CATALOG (OBB767)

Use the specified refrigerant only

Never use any refrigerant other than that specified.

Doing so may cause a burst, an explosion, or fire when the unit is being used, serviced, or disposed of.

Correct refrigerant is specified in the manuals and on the spec labels provided with our products.

We will not be held responsible for mechanical failure, system malfunction, unit breakdown or accidents caused by failure to follow the instructions.

Revision A:

- 9-2. CAPACITY AND INPUT CORRECTION BY OPERATIONAL FREQUENCY OF COMPRESSOR has been modified.
- Resistance value of the R.V. coil for MUZ-LN25/35/50VG- [E1], [ER1], [ET1] has been corrected (12-4.).

Revision B:

- MUZ-LN25VG2 - [E1], [ET1], MUZ-LN35VG2 - [E1], [ET1], and MUZ-LN50VG2 - [E1], [ET1] have been added.

1

TECHNICAL CHANGES

MUZ-LN25VG -[E1], [ER1], [ET1]

MUZ-LN35VG -[E1], [ER1], [ET1]

MUZ-LN50VG -[E1], [ER1], [ET1]

MUZ-LN60VG -[E1], [ER1], [ET1]

1. New model

MUZ-LN25VG -[E1], [ET1] → **MUZ-LN25VG2** -[E1], [ET1]

MUZ-LN35VG -[E1], [ET1] → **MUZ-LN35VG2** -[E1], [ET1]

MUZ-LN50VG -[E1], [ET1] → **MUZ-LN50VG2** -[E1], [ET1]

1. The heat exchanger has been changed.
2. The refrigerant amount has been changed.

Servicing precautions for units using refrigerant R32

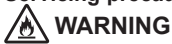

This unit uses a flammable refrigerant.

If refrigerant leaks and comes in contact with fire or heating part, it will create harmful gas and there is risk of fire.

- Do not use means to accelerate the defrosting process or to clean, other than those recommended by the manufacturer.
- The appliance shall be stored in a room without continuously operating ignition sources (for example: open flames, an operating gas appliance or an operating electric heater.)
- Do not pierce or burn.
- Be aware that refrigerants may not contain an odor.
- Pipe-work shall be protected from physical damage.
- The installation of pipe-work shall be kept to a minimum.
- Compliance with national gas regulations shall be observed.
- Keep any required ventilation openings clear of obstruction.
- Servicing shall be performed only as recommended by the manufacturer.
- The appliance shall be stored so as to prevent mechanical damage from occurring.

Basic work procedures are the same as those for conventional units using refrigerant R410A. However, pay careful attention to the following points.

1. Information on servicing
 - ① Checks on the Area

Prior to beginning work on systems containing flammable refrigerants, safety checks are necessary to ensure that the risk of ignition is minimized.
 - ② Work Procedure

Work shall be undertaken under a controlled procedure so as to minimize the risk of a flammable gas or vapor being present while the work is being performed.
 - ③ General Work Area

All maintenance staff and others working in the local area shall be instructed on the nature of work being carried out. Work in confined spaces shall be avoided. The area around the workspace shall be sectioned off. Ensure that the conditions within the area have been made safe by control of flammable material.
 - ④ Checking for Presence of Refrigerant

The area shall be checked with an appropriate refrigerant detector prior to and during work, to ensure the technician is aware of potentially toxic or flammable atmospheres. Ensure that the leak detection equipment being used is suitable for use with all applicable refrigerants, i.e. non-sparking, adequately sealed or intrinsically safe.
 - ⑤ Presence of Fire Extinguisher

If any hot work is to be conducted on the refrigeration equipment or any associated parts, appropriate fire extinguishing equipment shall be available to hand. Have a dry powder or CO2 fire extinguisher adjacent to the charging area.
 - ⑥ No Ignition Sources

No person carrying out work in relation to a refrigeration system which involves exposing any pipe work shall use any sources of ignition in such a manner that it may lead to the risk of fire or explosion. All possible ignition sources, including cigarette smoking, should be kept sufficiently far away from the site of installation, repairing, removing and disposal, during which refrigerant can possibly be released to the surrounding space. Prior to work taking place, the area around the equipment is to be surveyed to make sure that there are no flammable hazards or ignition risks. "No Smoking" signs shall be displayed.
 - ⑦ Ventilated Area

Ensure that the area is in the open or that it is adequately ventilated before breaking into the system or conducting any hot work. A degree of ventilation shall continue during the period that the work is carried out. The ventilation should safely disperse any released refrigerant and preferably expel it externally into the atmosphere.
 - ⑧ Checks on the Refrigeration Equipment

Where electrical components are being changed, they shall be fit for the purpose and to the correct specification. At all times the manufacturer's maintenance and service guidelines shall be followed. If in doubt, consult the manufacturer's technical department for assistance.

The following checks shall be applied to installations using flammable refrigerants:

 - The charge size is in accordance with the room size within which the refrigerant containing parts are installed.
 - The ventilation machinery and outlets are operating adequately and are not obstructed.
 - If an indirect refrigerating circuit is being used, the secondary circuit shall be checked for the presence of refrigerant.
 - Marking to the equipment continues to be visible and legible. Markings and signs that are illegible shall be corrected.
 - Refrigeration pipe or components are installed in a position where they are unlikely to be exposed to any substance which may corrode refrigerant containing components, unless the components are constructed of materials which are inherently resistant to being corroded or are suitably protected against being corroded.
 - ⑨ Checks on Electrical Devices

Repair and maintenance to electrical components shall include initial safety checks and component inspection procedures. If a fault exists that could compromise safety, then no electrical supply shall be connected to the circuit until it is satisfactorily dealt with. If the fault cannot be corrected immediately but it is necessary to continue operation, an adequate temporary solution shall be used. This shall be reported to the owner of the equipment so all parties are advised.

Initial safety checks shall include that:

 - capacitors are discharged: this shall be done in a safe manner to avoid possibility of sparking;
 - no live electrical components and wiring are exposed while charging, recovering or purging the system;
 - there is continuity of earth bonding
2. Repairs to Sealed Components
 - ① During repairs to sealed components, all electrical supplies shall be disconnected from the equipment being worked upon prior to any removal of sealed covers, etc. If it is absolutely necessary to have an electrical supply to equipment during servicing, then a permanently operating form of leak detection shall be located at the most critical point to warn of a potentially hazardous situation.
 - ② Particular attention shall be paid to the following to ensure that by working on electrical components, the casing is not altered in such a way that the level of protection is affected. This shall include damage to cables, excessive number of connections, terminals not made to original specification, damage to seals, incorrect fitting of glands, etc.

Ensure that the apparatus is mounted securely.

Ensure that seals or sealing materials have not degraded to the point that they no longer serve the purpose of preventing the ingress of flammable atmospheres. Replacement parts shall be in accordance with the manufacturer's specifications.
3. Repair to Intrinsic Safe Components

Do not apply any permanent inductive or capacitance loads to the circuit without ensuring that this will not exceed the permissible voltage and current permitted for the equipment in use.

Intrinsic safe components are the only types that can be worked on while live in the presence of a flammable atmosphere. The test apparatus shall be at the correct rating.

Replace components only with parts specified by the manufacturer. Other parts may result in the ignition of refrigerant in the atmosphere from a leak.
4. Cabling

Check that cabling will not be subject to wear, corrosion, excessive pressure, vibration, sharp edges or any other adverse environmental effects. The check shall also take into account the effects of aging or continual vibration from sources such as compressors or fans.

5. **Detection of Flammable Refrigerants**
Under no circumstances shall potential sources of ignition be used in the searching for or detection of refrigerant leaks. A halide torch (or any other detector using a naked flame) shall not be used.
6. **Leak Detection Methods**
Electronic leak detectors may be used to detect refrigerant leaks but, in the case of flammable refrigerants, the sensitivity may not be adequate, or may need re-calibration. (Detection equipment shall be calibrated in a refrigerant-free area.) Ensure that the detector is not a potential source of ignition and is suitable for the refrigerant used. Leak detection equipment shall be set at a percentage of the LFL of the refrigerant and shall be calibrated to the refrigerant employed, and the appropriate percentage of gas (25 % maximum) is confirmed.
Leak detection fluids are suitable for use with most refrigerants but the use of detergents containing chlorine shall be avoided as the chlorine may react with the refrigerant and corrode the copper pipe-work.
If a leak is suspected, all naked flames shall be removed/extinguished.
If a leakage of refrigerant is found which requires brazing, all of the refrigerant shall be recovered from the system, or isolated (by means of shut off valves) in a part of the system remote from the leak. For appliances containing flammable refrigerants, oxygen free nitrogen (OFN) shall then be purged through the system both before and during the brazing process.
7. **Removal and Evacuation**
When breaking into the refrigerant circuit to make repairs - or for any other purpose conventional procedures shall be used. However, for flammable refrigerants it is important that best practice is followed since flammability is a consideration. The following procedure shall be adhered to:
- remove refrigerant
 - purge the circuit with inert gas
 - evacuate
 - purge again with inert gas
 - open the circuit by cutting or brazing.
- The refrigerant charge shall be recovered into the correct recovery cylinders. For appliances containing flammable refrigerants, the system shall be "flushed" with OFN to render the unit safe. This process may need to be repeated several times. Compressed air or oxygen shall not be used for purging refrigerant systems.
For appliances containing flammable refrigerants, flushing shall be achieved by breaking the vacuum in the system with OFN and continuing to fill until the working pressure is achieved, then venting to atmosphere, and finally pulling down to a vacuum. This process shall be repeated until no refrigerant is within the system. When the final OFN charge is used, the system shall be vented down to atmospheric pressure to enable work to take place. This operation is absolutely vital if brazing operations on the pipe-work are to take place.
Ensure that the outlet for the vacuum pump is not close to any ignition sources and that ventilation is available.
8. **Charging Procedures**
In addition to conventional charging procedures, the following requirements shall be followed:
- Ensure that contamination of different refrigerants does not occur when using charging equipment. Hoses or lines shall be as short as possible to minimize the amount of refrigerant contained in them.
 - Cylinders shall be kept upright.
 - Ensure that the refrigeration system is earthed prior to charging the system with refrigerant.
 - Label the system when charging is complete (if not already).
 - Extreme care shall be taken not to overfill the refrigeration system.
- Prior to recharging the system, it shall be pressure-tested with the appropriate purging gas. The system shall be leak-tested on completion of charging but prior to commissioning. A follow up leak test shall be carried out prior to leaving the site.
9. **Decommissioning**
Before carrying out this procedure, it is essential that the technician is completely familiar with the equipment and all its detail. It is recommended good practice that all refrigerants are recovered safely. Prior to the task being carried out, an oil and refrigerant sample shall be taken in case analysis is required prior to re-use of reclaimed refrigerant. It is essential that electrical power is available before the task is commenced.
- a) Become familiar with the equipment and its operation.
 - b) Isolate system electrically.
 - c) Before attempting the procedure, ensure that:
 - mechanical handling equipment is available, if required, for handling refrigerant cylinders;
 - all personal protective equipment is available and being used correctly;
 - the recovery process is supervised at all times by a competent person;
 - recovery equipment and cylinders conform to the appropriate standards.
 - d) Pump down refrigerant system, if possible.
 - e) If a vacuum is not possible, make a manifold so that refrigerant can be removed from various parts of the system.
 - f) Make sure that cylinder is situated on the scales before recovery takes place.
 - g) Start the recovery machine and operate in accordance with manufacturer's instructions.
 - h) Do not overfill cylinders. (no more than 80 % volume liquid charge).
 - i) Do not exceed the maximum working pressure of the cylinder, even temporarily.
 - j) When the cylinders have been filled correctly and the process completed, make sure that the cylinders and the equipment are removed from site promptly and all isolation valves on the equipment are closed off.
 - k) Recovered refrigerant shall not be charged into another refrigeration system unless it has been cleaned and checked.
10. **Labeling**
Equipment shall be labeled stating that it has been de-commissioned and emptied of refrigerant. The label shall be dated and signed. For appliances containing flammable refrigerants, ensure that there are labels on the equipment stating the equipment contains flammable refrigerant.
11. **Recovery**
When removing refrigerant from a system, either for servicing or decommissioning, it is recommended good practice that all refrigerants are removed safely. When transferring refrigerant into cylinders, ensure that only appropriate refrigerant recovery cylinders are employed. Ensure that the correct number of cylinders for holding the total system charge are available. All cylinders to be used are designated for the recovered refrigerant and labeled for that refrigerant (i.e. special cylinders for the recovery of refrigerant). Cylinders shall be complete with pressure-relief valve and associated shut-off valves in good working order. Empty recovery cylinders are evacuated and, if possible, cooled before recovery occurs.
The recovery equipment shall be in good working order with a set of instructions concerning the equipment that is at hand and shall be suitable for the recovery of all appropriate refrigerants including, when applicable, flammable refrigerants. In addition, a set of calibrated weighing scales shall be available and in good working order. Hoses shall be complete with leak-free disconnect couplings and in good condition. Before using the recovery machine, check that it is in satisfactory working order, has been properly maintained and that any associated electrical components are sealed to prevent ignition in the event of a refrigerant release. Consult manufacturer if in doubt.
The recovered refrigerant shall be returned to the refrigerant supplier in the correct recovery cylinder, and the relevant waste transfer note arranged. Do not mix refrigerants in recovery units and especially not in cylinders.
If compressors or compressor oils are to be removed, ensure that they have been evacuated to an acceptable level to make certain that flammable refrigerant does not remain within the lubricant. The evacuation process shall be carried out prior to returning the compressor to the suppliers. Only electric heating to the compressor body shall be employed to accelerate this process. When oil is drained from a system, it shall be carried out safely.

3

PART NAMES AND FUNCTIONS

MUZ-LN25VG MUZ-LN25VG2
 MUZ-LN35VG MUZ-LN35VG2

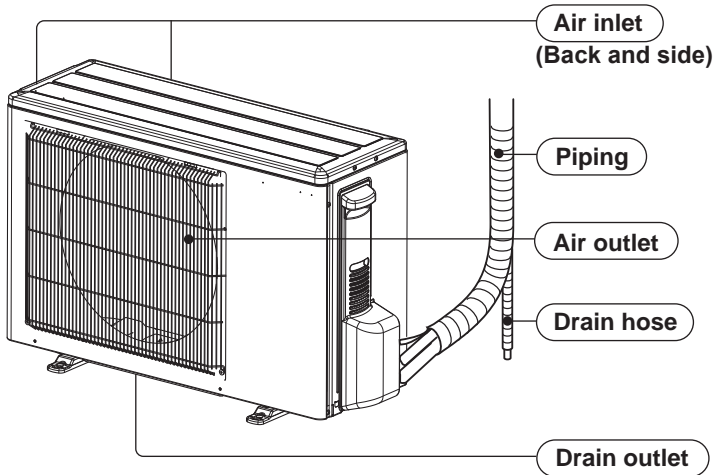

MUZ-LN50VG MUZ-LN50VG2

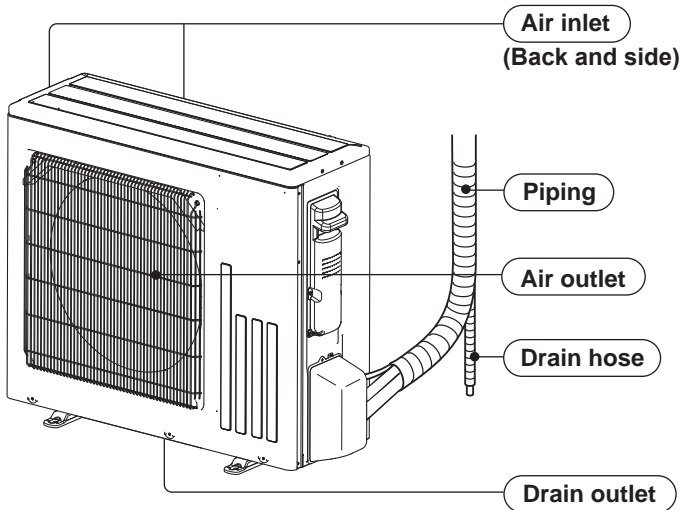

MUZ-LN60VG

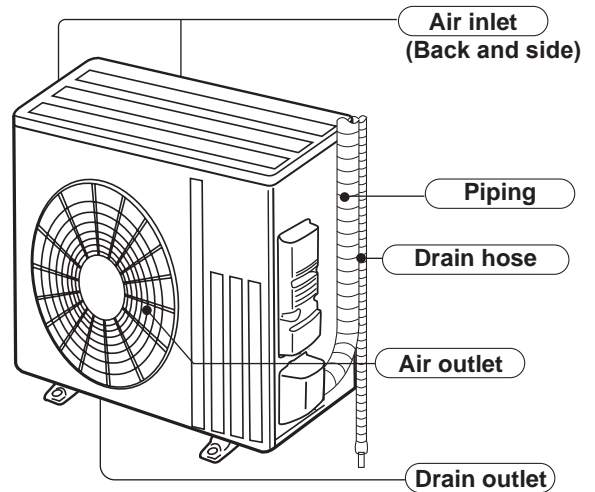

ACCESSORIES

Model	MUZ-LN25VG MUZ-LN35VG MUZ-LN50VG MUZ-LN60VG	MUZ-LN25VG2 MUZ-LN35VG2 MUZ-LN50VG2
Drain socket	1	

4

SPECIFICATION

Outdoor model				MUZ-LN25VG	MUZ-LN25VG2	MUZ-LN35VG	MUZ-LN35VG2	
Power supply				Single phase, 230 V, 50 Hz				
Capacity Rated (Min.-Max.)	Cooling	kW		2.5 (1.0 - 3.5)	2.5 (1.0 - 3.5)	3.5 (0.8 - 4.0)	3.5 (0.8 - 4.0)	
	Heating			3.2 (0.8 - 5.4)	3.2 (0.7 - 5.4)	4.0 (1.0 - 6.3)	4.0 (0.9 - 6.3)	
Breaker Capacity			A	10	10	10	10	
Electrical data	Power input *1 (Set)	Cooling	W	485	485	820	820	
		Heating		580	600	800	820	
	Running current *1 (Set)	Cooling	A	2.5	2.7	3.9	3.8	
		Heating		3.0	3.4	4.0	3.8	
	Power factor *1 (Set)	Cooling	%	84	78	91	93	
		Heating		84	76	86	93	
Starting current *1 (Set)			A	3.0	3.4	4.0	3.8	
Coefficient of performance (COP) *1 (Set)		Cooling		5.15	5.15	4.27	4.27	
		Heating		5.52	5.33	5.00	4.88	
Compressor	Model			KVB073FYXMC	KVB073FYXMC	SVB092FBAMT	SVB092FBAMT	
	Output		W	470	470	660	660	
	Current *1	Cooling	A	2.03	2.24	3.41	3.32	
		Heating		2.50	2.95	3.48	3.32	
Refrigeration oil (Model)			L	0.27 (FW68S)	0.27 (FW68S)	0.35 (FW68S)	0.35 (FW68S)	
Fan motor	Model			RC0J50-RB	RC0J50-NC	RC0J50-RB	RC0J50-NC	
	Current *1	Cooling	A	0.26	0.21	0.26	0.23	
		Heating		0.22	0.26	0.25	0.26	
Dimensions W x H x D			mm	800 x 550 x 285	800 x 550 x 285	800 x 550 x 285	800 x 550 x 285	
Weight			kg	35	33	35	34	
Special remarks	Dehumidification		Cooling	L/h	0.1	0.1	0.5	0.5
	Airflow *1	Cooling	High	m ³ /h	2,124	2,058	2,124	2,058
			Low		978	984	978	984
		Heating	High		2,028	2,058	2,028	2,058
			Med.		1,734	1,776	1,734	1,776
			Low		1,302	1,356	1,302	1,356
	Sound level *1	Cooling		dB(A)	46	46	49	49
		Heating			49	49	50	50
	Fan speed	Cooling	High	rpm	940	940	940	940
			Low		460	490	460	490
		Heating	High		900	940	900	940
			Med.		780	820	780	820
			Low		600	640	600	640
Fan speed regulator					3	3	3	
Refrigerant filling capacity (R32)			kg	1.00	0.8	1.00	0.85	

NOTE: Test conditions are based on ISO 5151.

Cooling: Indoor Dry-bulb temperature 27°C Wet-bulb temperature 19°C

Outdoor Dry-bulb temperature 35°C Wet-bulb temperature 24°C

Heating: Indoor Dry-bulb temperature 20°C

Outdoor Dry-bulb temperature 7°C Wet-bulb temperature 6°C

*1 Measured under rated operating frequency.

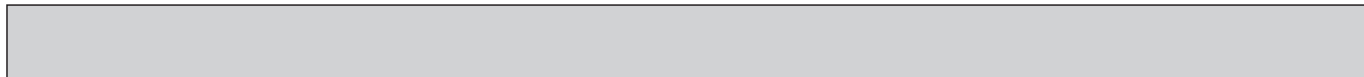

Outdoor model				MUZ-LN50VG	MUZ-LN50VG2	MUZ-LN60VG	
Power supply				Single phase, 230 V, 50 Hz			
Capacity Rated (Min. - Max.)	Cooling	kW	5.0 (1.0 - 6.0)	5.0 (1.0 - 6.0)	6.1 (1.4 - 6.9)		
	Heating		6.0 (1.0 - 8.2)	6.0 (1.0 - 8.2)	6.8 (1.8 - 9.3)		
Breaker Capacity			A	16	16	16	
Electrical data	Power input *1 (Set)	Cooling	W	1,380	1,380	1,790	
		Heating		1,480	1,480	1,810	
	Running current *1 (Set)	Cooling	A	6.3	6.3	7.9	
		Heating		6.8	6.8	7.9	
	Power factor *1 (Set)	Cooling	%	95	95	98	
		Heating		94	94	99	
Starting current *1 (Set)			A	6.8	6.8	7.9	
Coefficient of performance (COP) *1 (Set)		Cooling	3.62	3.62	3.41		
		Heating	4.05	4.05	3.76		
Compressor	Model			SVB130FBBMT	SVB130FBBMT	SVB172FCKMT	
	Output		W	900	900	1,200	
	Current *1	Cooling	A	5.73	5.73	6.70	
		Heating		6.18	6.18	6.69	
Refrigeration oil (Model)			L	0.35 (FW68S)	0.35 (FW68S)	0.40 (FW68S)	
Fan motor	Model			RC0J50-RA	RC0J50-RA	RC0J60-BC	
	Current *1	Cooling	A	0.29	0.29	0.84	
		Heating		0.29	0.29	0.84	
Dimensions W x H x D			mm	800 x 714 x 285	800 x 714 x 285	840 x 880 x 330	
Weight			kg	40	40	55	
Special remarks	Dehumidification		Cooling	L/h	1.7	1.7	2.2
	Airflow *1	Cooling	High	m ³ /h	2,748	2,748	3,006
			Low		1,320	1,320	1,716
		Heating	High		2,622	2,622	3,006
			Med.		2,238	2,238	2,892
			Low		1,704	1,704	2,280
	Sound level *1		Cooling	dB(A)	51	51	55
			Heating		54	54	55
	Fan speed	Cooling	High	rpm	940	940	840
			Low		490	490	450
		Heating	High		900	900	840
			Med.		780	780	810
			Low		610	610	650
Fan speed regulator				3	3	3	
Refrigerant filling capacity (R32)			kg	1.25	1.25	1.45	

NOTE: Test conditions are based on ISO 5151.

Cooling: Indoor Dry-bulb temperature 27°C Wet-bulb temperature 19°C

Outdoor Dry-bulb temperature 35°C Wet-bulb temperature 24°C

Heating: Indoor Dry-bulb temperature 20°C

Outdoor Dry-bulb temperature 7°C Wet-bulb temperature 6°C

*1 Measured under rated operating frequency.



Specifications and rated conditions of main electric parts

Model		MUZ-LN25VG	MUZ-LN35VG	MUZ-LN50VG
Smoothing capacitor	(C62, C63)	600 μF/ 620 μF 420 V		-
	(C61, C62, C63)	-		600 μF/ 620 μF 420 V
Diode module	(DB61)	15 A 600 V		25 A 600 V
	(DB65)	25A 600V		
Fuse	(F701, F801, F901)	T3.15AL250V		
Power module	(IC700)	15 A 600 V		20 A 600 V
	(IC932)	5 A 600 V		
Expansion valve coil	(LEV)	12 V DC		
Reactor	(L61)	23 mH		
Switching power transistor	(Q821)	30 A 600 V		
Circuit protection	(PTC64, PTC65)	33 Ω		
Terminal block	(TB1)	5 P		
Relay	(X63)	3 A 250 V		
	(X64)	20 A 250 V		
	(X69)	10 A 230 V		
R.V. coil	(21S4)	220-240 V AC		

Specifications and rated conditions of main electric parts

Model		MUZ-LN25VG2	MUZ-LN35VG2	MUZ-LN50VG2
Smoothing capacitor	(C62, C63)	600 μF/ 620 μF 420 V		-
	(C61, C62, C63)	-		600 μF/ 620 μF 420 V
Diode module	(DB61)	15 A 600 V		25 A 600 V
	(DB65)	25 A 600 V		
Fuse	(F701, F801, F901)	T3.15AL250V		
Power module	(IC700)	15 A 600 V		20 A 600 V
	(IC932)	5 A 600 V		
Expansion valve coil	(LEV)	12 V DC		
Reactor	(L61)	23 mH		
Switching power transistor	(Q821)	30 A 600 V		
Circuit protection	(PTC64, PTC65)	33 Ω		
Terminal block	(TB1)	5 P		
Relay	(X63)	3 A 250 V		
	(X64)	20 A 250 V		
	(X69)	10 A 230 V		
R.V. coil	(21S4)	220-240 V AC		

Specifications and rated conditions of main electric parts

Model		MUZ-LN60VG
Smoothing capacitor	(CB1, CB2, CB3)	560 μF 450 V
Fuse	(F601, F880, F901)	T3.15AL250 V
Switching power transistor	(Q3A, Q3B)	21 A 650 V
Power module	(IC932)	5 A 600 V
	(IC700)	20 A 600 V
Expansion valve coil	(LEV)	12 V DC
Reactor	(L)	282 μH
Diode	(D3A, D3B)	20 A 600 V
Diode module	(DB41A, DB41B)	20 A 600 V
Circuit protection	(PTC64, PTC65)	33 Ω
Terminal block	(TB1, TB2)	3 P
Relay	(X64)	20 A 250 V
	(X65)	20 A 250 V
	(X69)	10 A 250 V
	(X601)	3 A 250 V
	(X602)	3 A 250 V
R.V. coil	(21S4)	220-240 V AC

5

NOISE CRITERIA CURVES

MUZ-LN25VG

FUNCTION	SPL(dB(A))	LINE
COOLING	46	●—●
HEATING	49	○—○

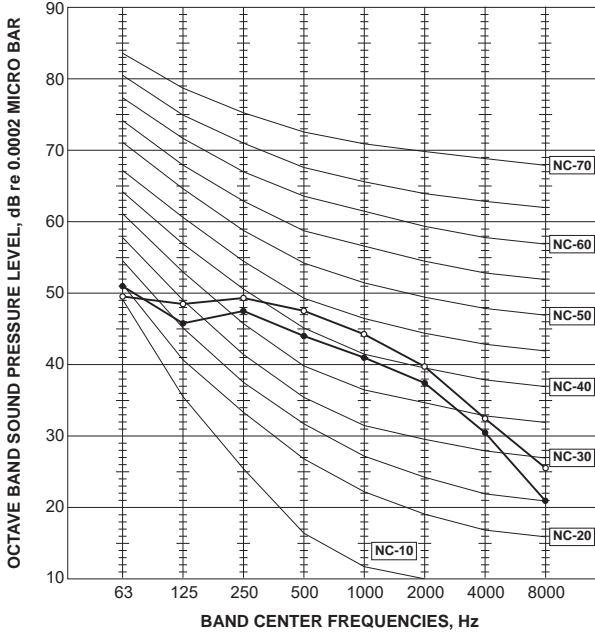

MUZ-LN25VG2

FUNCTION	SPL(dB(A))	LINE
COOLING	46	●—●
HEATING	49	○—○

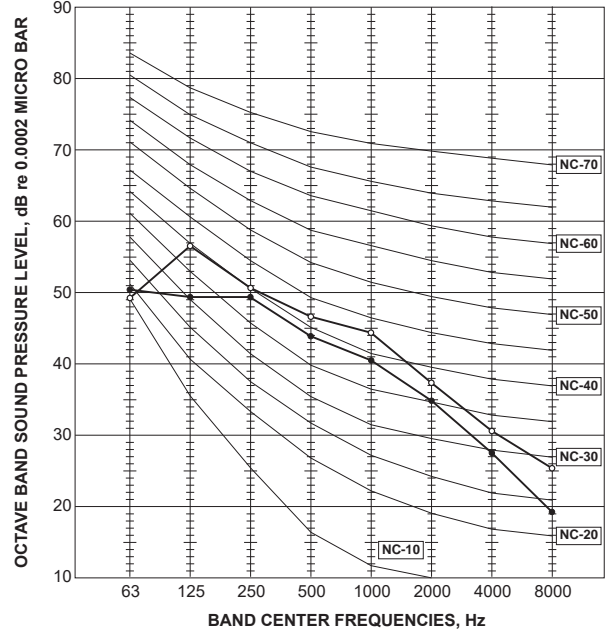

MUZ-LN35VG

FUNCTION	SPL(dB(A))	LINE
COOLING	49	●—●
HEATING	50	○—○

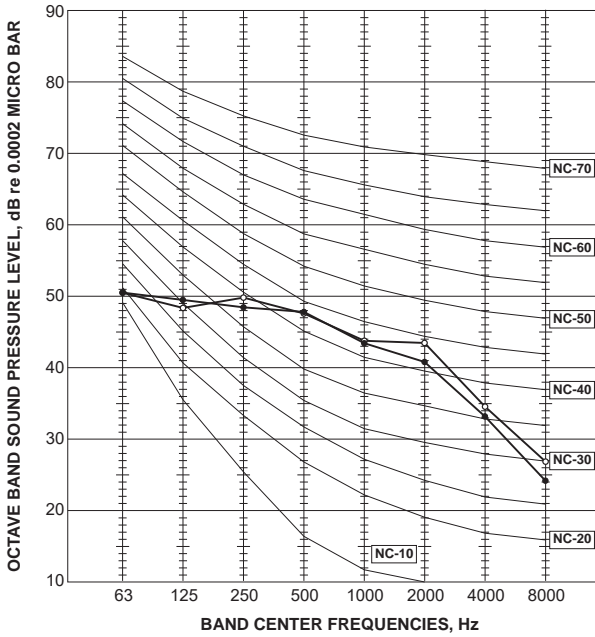

MUZ-LN35VG2

FUNCTION	SPL(dB(A))	LINE
COOLING	49	●—●
HEATING	50	○—○

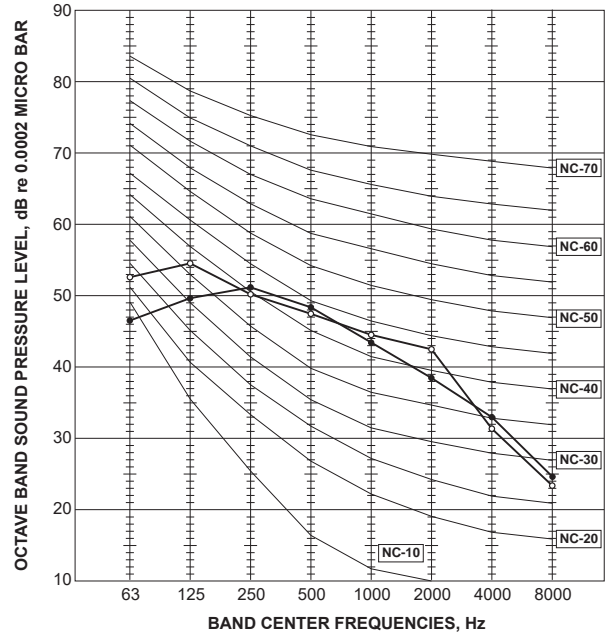

MUZ-LN50VG MUZ-LN50VG2

FUNCTION	SPL(dB(A))	LINE
COOLING	51	●—●
HEATING	54	○—○

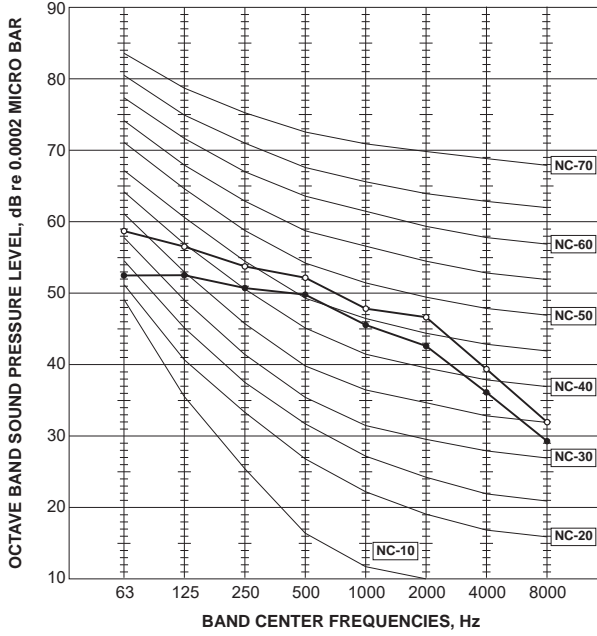

MUZ-LN60VG

FUNCTION	SPL(dB(A))	LINE
COOLING	55	●—●
HEATING	55	○—○

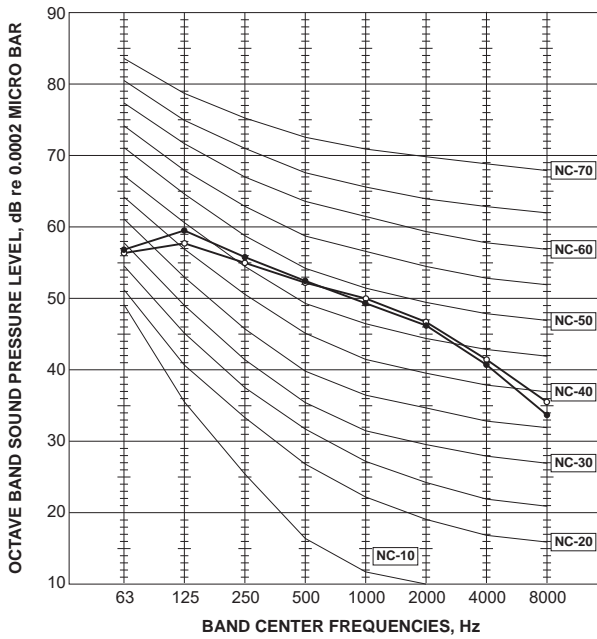

Test conditions

Cooling: Dry-bulb temperature 35°C

Heating: Dry-bulb temperature 7°C Wet-bulb temperature 6°C

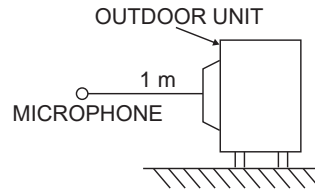

6

OUTLINES AND DIMENSIONS

MUZ-LN25VG MUZ-LN35VG
 MUZ-LN25VG2 MUZ-LN35VG2

Unit: mm

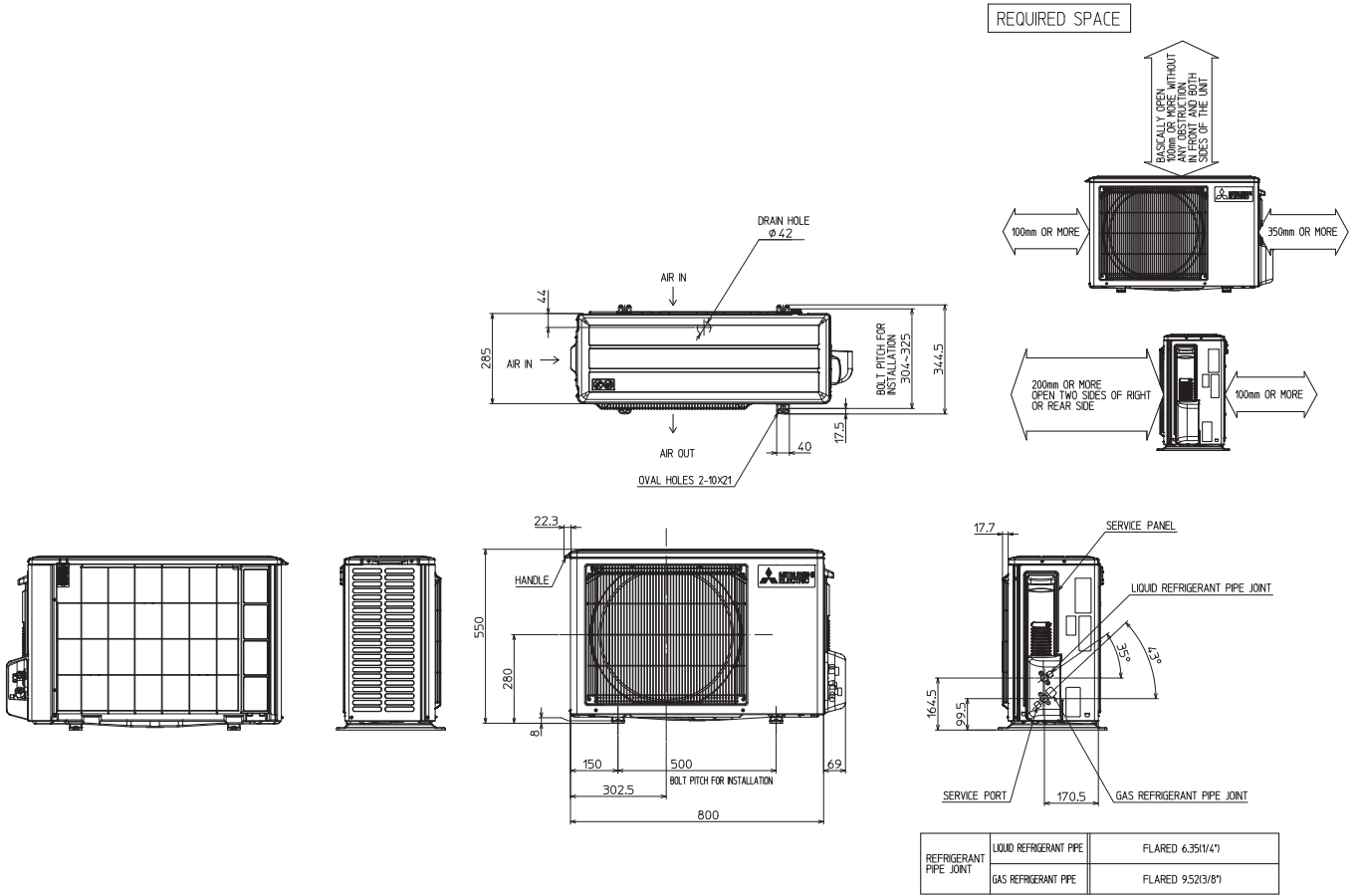

MUZ-LN50VG
MUZ-LN50VG2

Unit: mm

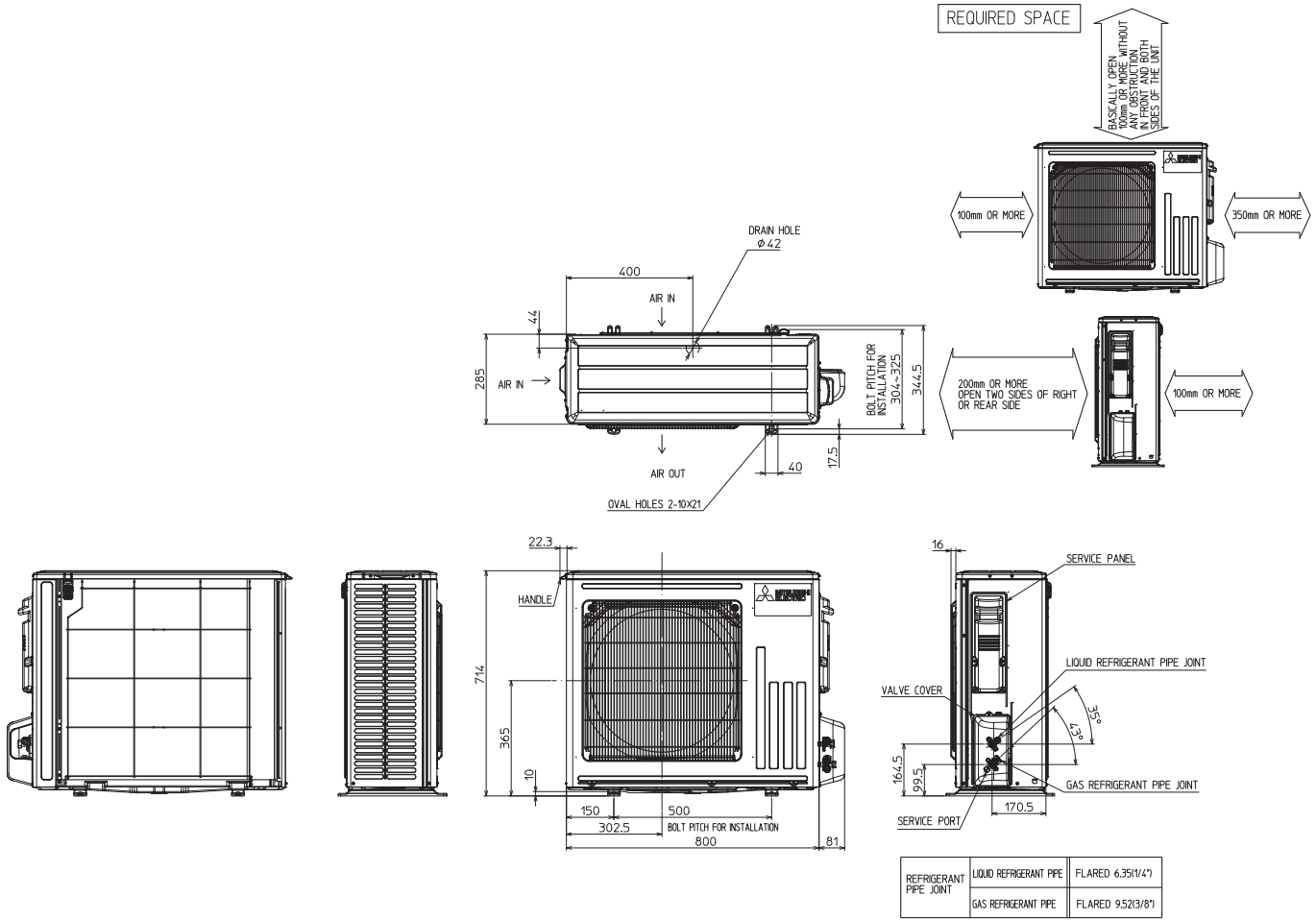

MUZ-LN60VG

Unit: mm

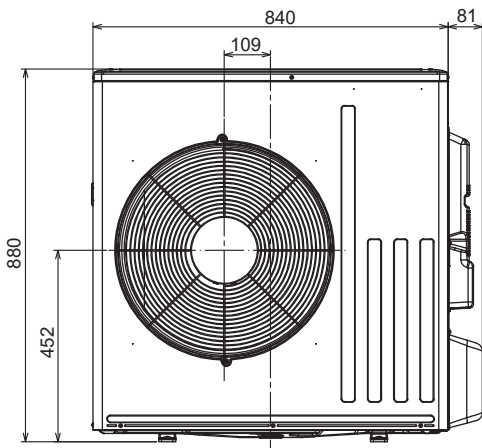
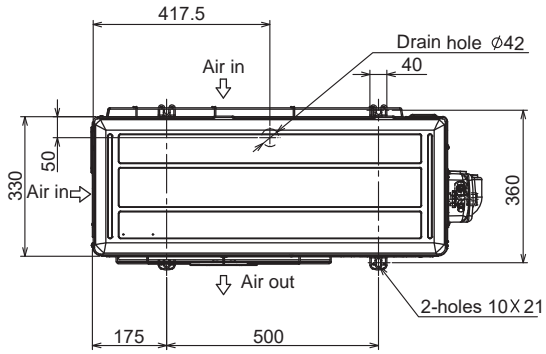

REQUIRED SPACE

*1 500 mm or more when front and sides of the unit are clear

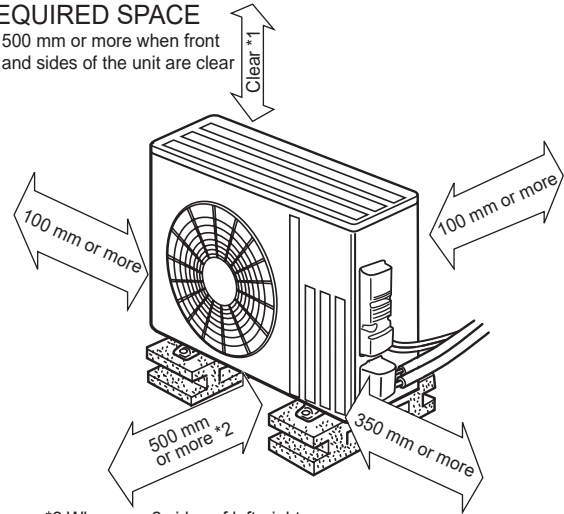

*2 When any 2 sides of left, right and rear of the unit are clear

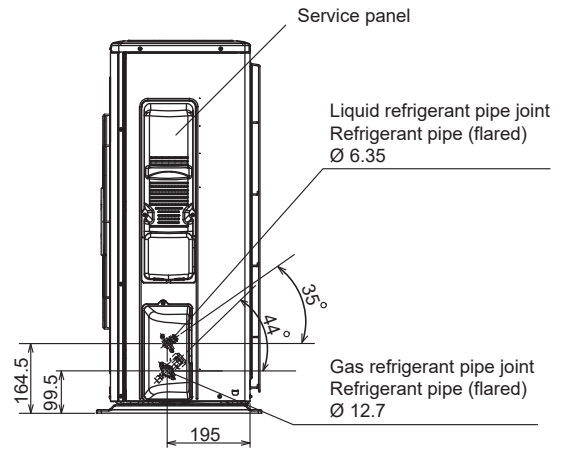

MUZ-LN25VG MUZ-LN35VG

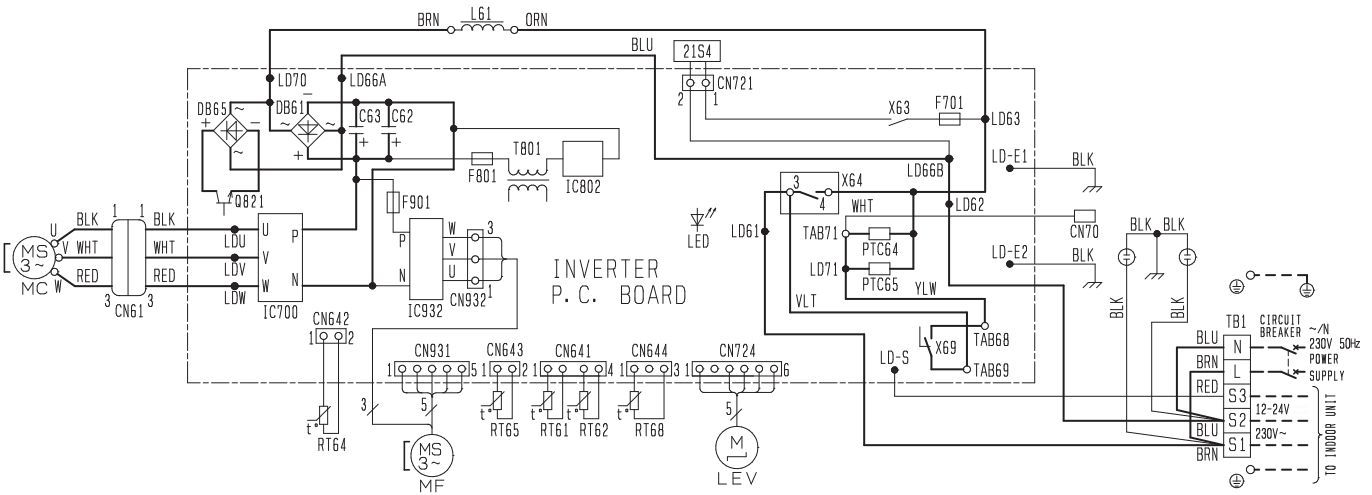

NOTES:

- About the indoor side electric wiring refer to the indoor unit electric wiring diagram for servicing.
- Use copper supply wires.
- Symbols indicate, : Terminal block
 : Connector

SYMBOL	NAME	SYMBOL	NAME	SYMBOL	NAME
CN61	CONNECTOR	L61	REACTOR	RT64	FIN TEMP. THERMISTOR
C62, C63	SMOOTHING CAPACITOR	MC	COMPRESSOR	RT65	AMBIENT TEMP. THERMISTOR
DB61, DB65	DIODE MODULE	MF	FAN MOTOR	RT68	OUTDOOR HEAT EXCHANGER TEMP. THERMISTOR
F701, F801, F901	FUSE (T3. 15A/250V)	PTC64, PTC65	CIRCUIT PROTECTION	TB1	TERMINAL BLOCK
IC700, IC932	POWER MODULE	Q821	SWITCHING POWER TRANSISTOR	T801	TRANSFORMER
IC802	POWER DEVICE	RT61	DEFROST THERMISTOR	X63, X64, X69	RELAY
LED	LED	RT62	DISCHARGE TEMP. THERMISTOR	21S4	REVERSING VALVE COIL
LEV	EXPANSION VALVE COIL				

MUZ-LN25VG2 MUZ-LN35VG2

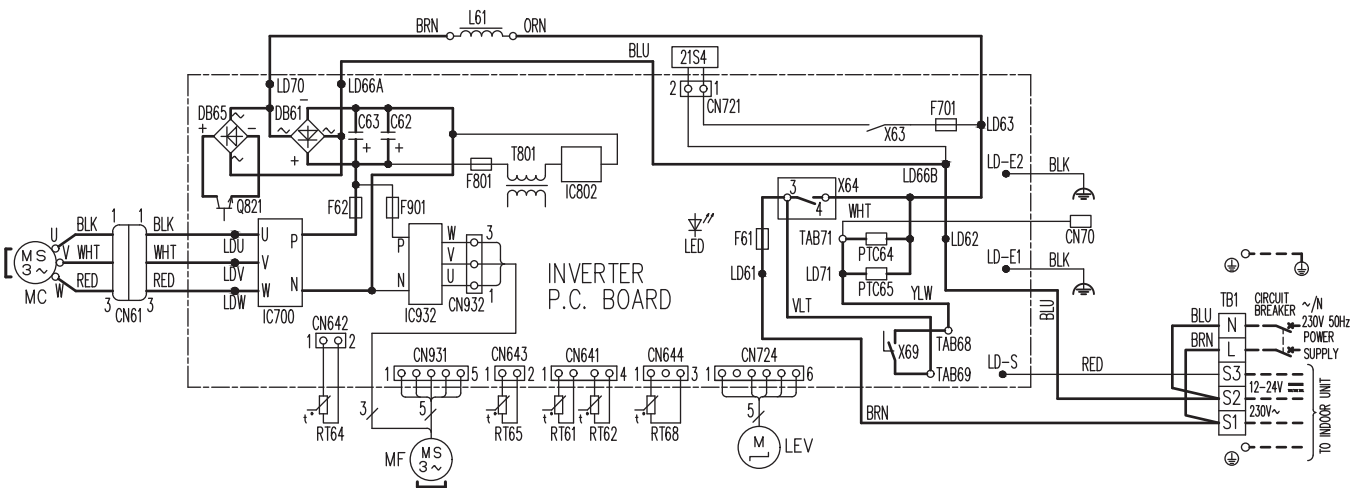

NOTES:

- About the indoor side electric wiring, refer to the indoor unit electric wiring diagram for servicing.
- Use copper supply wires.
- Symbols indicate, : Terminal block
 : Connector

SYMBOL	NAME	SYMBOL	NAME	SYMBOL	NAME
CN61	CONNECTOR	LEV	EXPANSION VALVE COIL	RT65	AMBIENT TEMP. THERMISTOR
C62, C63	SMOOTHING CAPACITOR	L61	REACTOR	RT68	OUTDOOR HEAT EXCHANGER TEMP. THERMISTOR
DB61, DB65	DIODE MODULE	MC	COMPRESSOR	TB1	TERMINAL BLOCK
F61	FUSE (25A 250V)	MF	FAN MOTOR	T801	TRANSFORMER
F62	FUSE (15A 250V)	PTC64, PTC65	CIRCUIT PROTECTION	X63, X64, X69	RELAY
F701, F801, F901	FUSE (T3.15A/250V)	Q821	SWITCHING POWER TRANSISTOR	21S4	REVERSING VALVE COIL
IC700, IC932	POWER MODULE	RT61	DEFROST THERMISTOR		
IC802	POWER DEVICE	RT62	DISCHARGE TEMP. THERMISTOR		
LED	LED	RT64	FIN TEMP. THERMISTOR		

MUZ-LN50VG

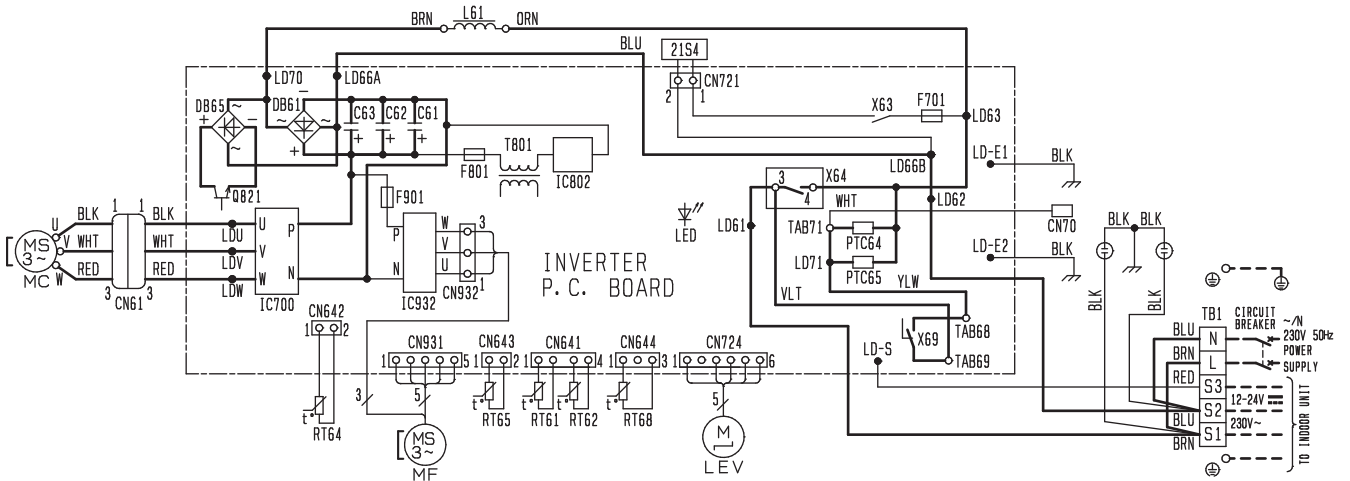

- NOTES:
- About the indoor side electric wiring refer to the indoor unit electric wiring diagram for servicing.
 - Use copper supply wires.
 - Symbols indicate, : Terminal block
 : Connector

SYMBOL	NAME	SYMBOL	NAME	SYMBOL	NAME
CN61	CONNECTOR	L61	REACTOR	RT64	FIN TEMP. THERMISTOR
C61, C62, C63	SMOOTHING CAPACITOR	MC	COMPRESSOR	RT65	AMBIENT TEMP. THERMISTOR
DB61, DB65	DIODE MODULE	MF	FAN MOTOR	RT68	OUTDOOR HEAT EXCHANGER TEMP. THERMISTOR.
F701, F801, F901	FUSE (T3.15A/250V)	PTC64, PTC65	CIRCUIT PROTECTION	TB1	TERMINAL BLOCK
IC700, IC932	POWER MODULE	Q821	SWITCHING POWER TRANSISTOR	T801	TRANSFORMER
IC802	POWER DEVICE	RT61	DEFROST THERMISTOR	X63, X64, X69	RELAY
LED	LED	RT62	DISCHARGE TEMP. THERMISTOR	21S4	REVERSING VALVE COIL
LEV	EXPANSION VALVE COIL				

MUZ-LN50VG2

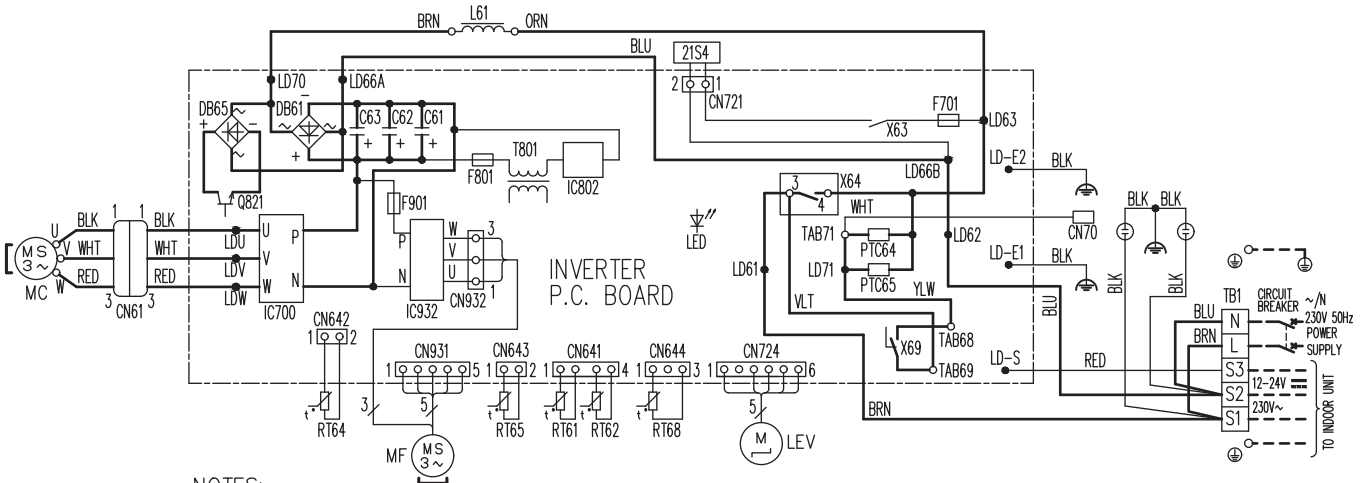

- NOTES:
- About the indoor side electric wiring refer to the indoor unit electric wiring diagram for servicing.
 - Use copper supply wires.
 - Symbols indicate, : Terminal block
 : Connector

SYMBOL	NAME	SYMBOL	NAME	SYMBOL	NAME
CN61	CONNECTOR	L61	REACTOR	RT65	AMBIENT TEMP. THERMISTOR
C61, C62, C63	SMOOTHING CAPACITOR	MC	COMPRESSOR	RT68	OUTDOOR HEAT EXCHANGER TEMP. THERMISTOR
DB61, DB65	DIODE MODULE	MF	FAN MOTOR	TB1	TERMINAL BLOCK
F701, F801, F901	FUSE (T3.15A/250V)	PTC64, PTC65	CIRCUIT PROTECTION	T801	TRANSFORMER
IC700, IC932	POWER MODULE	Q821	SWITCHING POWER TRANSISTOR	X63, X64, X69	RELAY
IC802	POWER DEVICE	RT61	DEFROST THERMISTOR	21S4	REVERSING VALVE COIL
LED	LED	RT62	DISCHARGE TEMP. THERMISTOR		
LEV	EXPANSION VALVE COIL	RT64	FIN TEMP. THERMISTOR		

MUZ-LN60VG

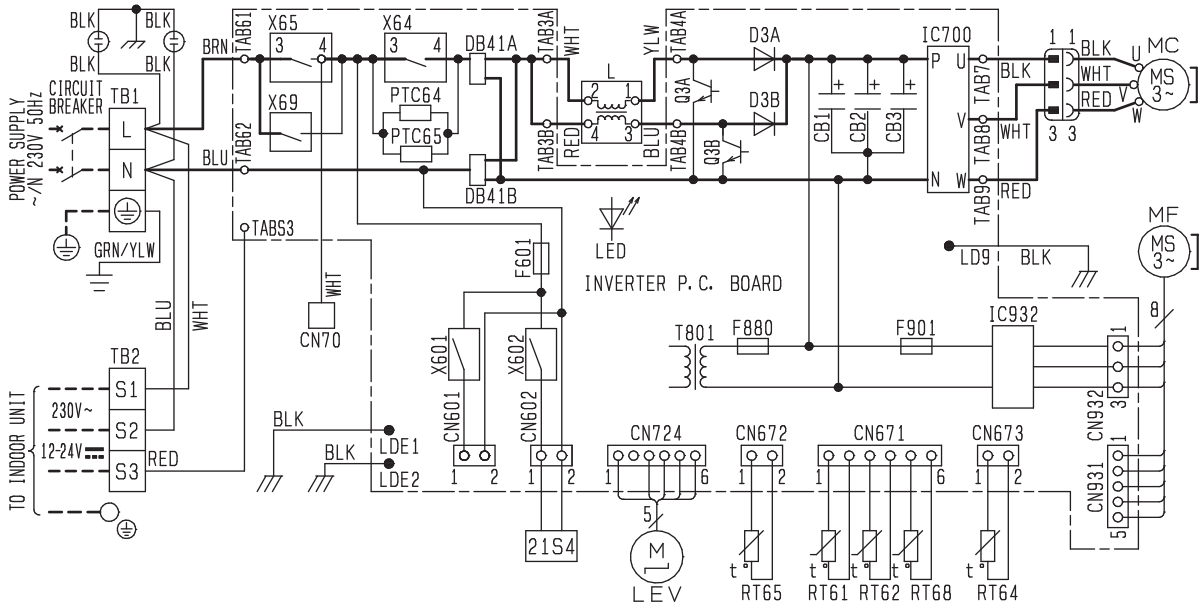

SYMBOL	NAME	SYMBOL	NAME	SYMBOL	NAME	SYMBOL	NAME
CB1, CB2, CB3	SMOOTHING CAPACITOR	L	REACTOR	RT61	DEFROST THERMISTOR	T801	TRANSFORMER
DB41A, DB41B	DIODE MODULE	LED	LED	RT62	DISCHARGE TEMP. THERMISTOR	X64, X65, X69	RELAY
D3A, D3B	DIODE	LEV	EXPANSION VALVE COIL	RT64	FIN TEMP. THERMISTOR	X601, X602	RELAY
F601	FUSE (T3. 15AL250V)	MC	COMPRESSOR	RT65	AMBIENT TEMP. THERMISTOR	21S4	REVERSING VALVE COIL
F880	FUSE (T3. 15AL250V)	MF	FAN MOTOR	RT68	OUTDOOR HEAT EXCHANGER TEMP. THERMISTOR		
F901	FUSE (T3. 15AL250V)	PTC64, PTC65	CIRCUIT PROTECTION				
IC700, IC932	POWER MODULE	Q3A, Q3B	SWITCHING POWER TRANSISTOR	TB1, TB2	TERMINAL BLOCK		

NOTES 1. About the indoor side electric wiring, refer to the indoor unit electric wiring diagram for servicing.
 2. Use copper supply wires. 3. Symbols indicate, :Terminal block :Connector

MUZ-LN25VG MUZ-LN35VG
 MUZ-LN25VG2 MUZ-LN35VG2

Unit: mm

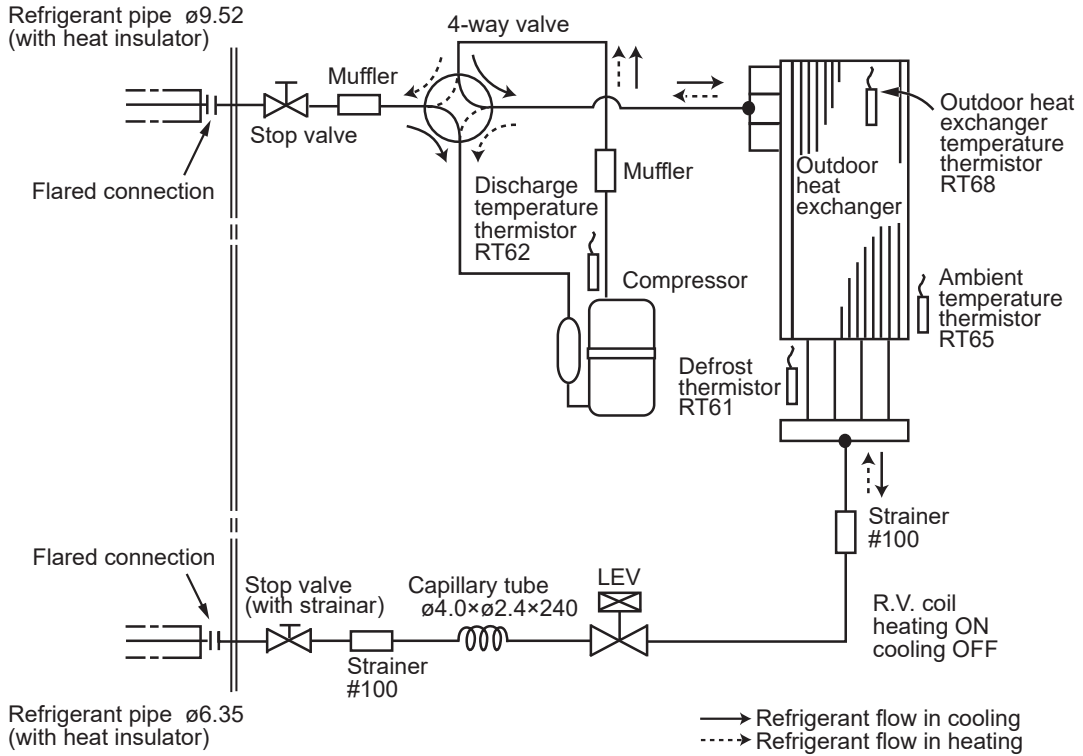

MUZ-LN50VG
 MUZ-LN50VG2

Unit: mm

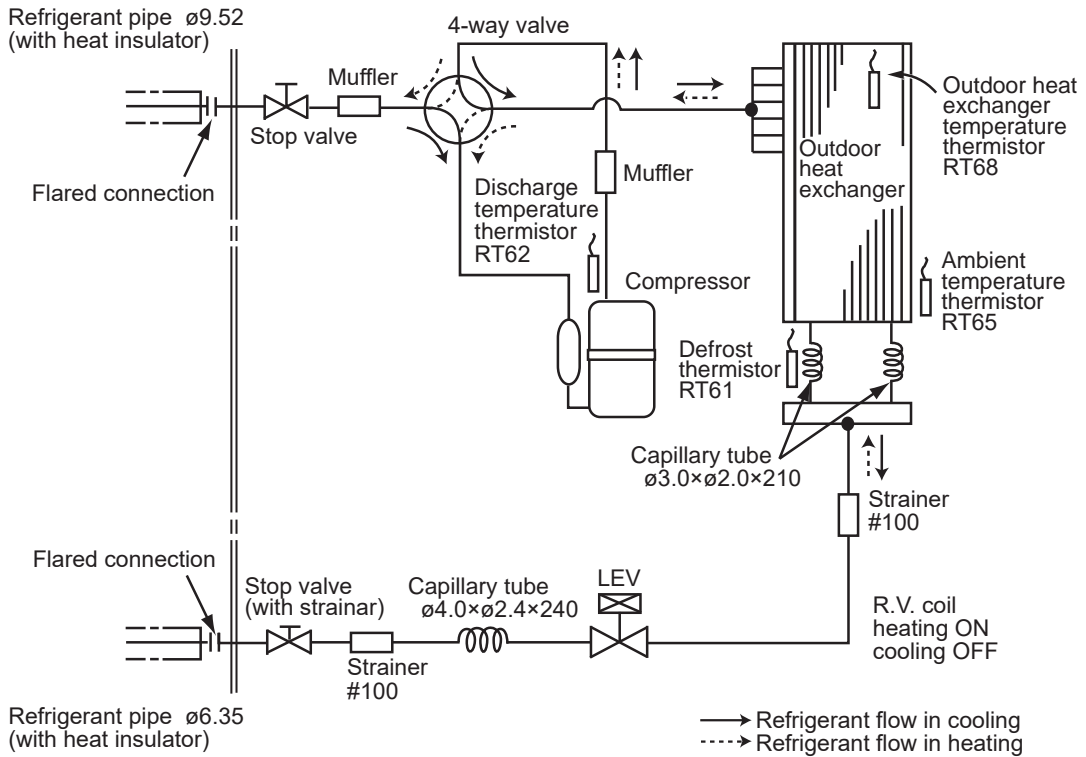

MUZ-LN60VG

Unit: mm

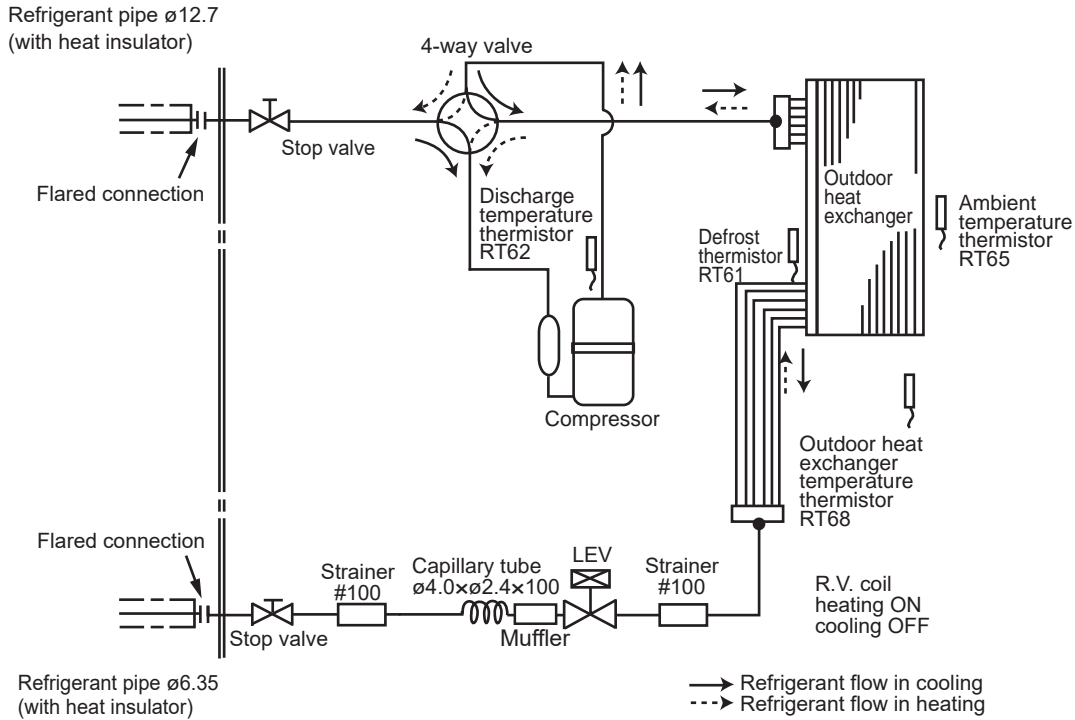

MAX. REFRIGERANT PIPING LENGTH and MAX. HEIGHT DIFFERENCE

Model	Refrigerant piping: m		Piping size O.D: mm	
	Max. Length A	Max. Height difference B	Gas	Liquid
MUZ-LN25VG MUZ-LN25VG2 MUZ-LN35VG MUZ-LN35VG2 MUZ-LN50VG	20	12	9.52	6.35
MUZ-LN50VG2	30	12	9.52	6.35
MUZ-LN60VG	30	15	12.7	6.35

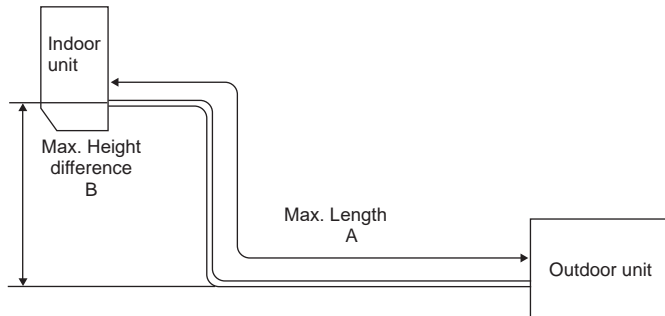

ADDITIONAL REFRIGERANT CHARGE (R32: g)

Model	Outdoor unit precharged	Refrigerant piping length (one way)									
		7 m	11 m	12 m	13 m	14 m	15 m	16 m	17 m	18 m	20 m
MUZ-LN25VG	1,000	0	80	100	120	140	160	180	200	220	260
MUZ-LN35VG	800	-	20	40	60	80	100	120	140	160	200
MUZ-LN25VG2	850	-	20	40	60	80	100	120	140	160	200
MUZ-LN35VG2	1,250	0	80	100	120	140	160	180	200	220	260
MUZ-LN50VG	1,250	-	-	-	-	-	0	20	40	60	100

Calculation

MUZ-LN25/35/50VG: $X g = 20 g/m \times (\text{Refrigerant piping length (m)} - 7)$

MUZ-LN25/35VG2: $X g = 20 g/m \times (\text{Refrigerant piping length (m)} - 10)$

MUZ-LN50VG2: $X g = 20 g/m \times (\text{Refrigerant piping length (m)} - 15)$

Model	Outdoor unit precharged	Refrigerant piping length (one way)					
		7 m	16 m	17 m	20 m	25 m	30 m
MUZ-LN60VG	1,450	0	180	200	260	360	460

Calculation: $X g = 20 g/m \times (\text{Refrigerant piping length (m)} - 7)$

9

PERFORMANCE CURVES

MUZ-LN25VG MUZ-LN35VG MUZ-LN50VG MUZ-LN60VG MUZ-LN25VG2 MUZ-LN35VG2 MUZ-LN50VG2

The standard specifications apply only to the operation of the air conditioner under normal conditions. Since operating conditions vary according to the areas where these units are installed, the following information has been provided to clarify the operating characteristics of the air conditioner under the conditions indicated by the performance curve.

(1) GUARANTEED VOLTAGE

198 ~ 264 V, 50 Hz

(2) AIRFLOW

Airflow should be set at MAX.

(3) MAIN READINGS

- | | | |
|--|---------|-----------|
| (1) Indoor intake air wet-bulb temperature: | °C [WB] | } Cooling |
| (2) Indoor outlet air wet-bulb temperature: | °C [WB] | |
| (3) Outdoor intake air dry-bulb temperature: | °C [DB] | |
| (4) Total input: | W | } Heating |
| (5) Indoor intake air dry-bulb temperature: | °C [DB] | |
| (6) Outdoor intake air wet-bulb temperature: | °C [WB] | |
| (7) Total input: | W | |

Indoor air wet and dry bulb temperature difference on the left side of the following chart shows the difference between the indoor intake air wet and dry bulb temperature and the indoor outlet air wet and dry bulb temperature for your reference at service.

How to measure the indoor air wet and dry bulb temperature difference

- Attach at least 2 sets of wet and dry bulb thermometers to the indoor air intake as shown in the figure, and at least 2 sets of wet and dry bulb thermometers to the indoor air outlet. The thermometers must be attached to the position where air speed is high.
- Attach at least 2 sets of wet and dry bulb thermometers to the outdoor air intake.
Cover the thermometers to prevent direct rays of the sun.
- Check that the air filter is cleaned.
- Open windows and doors of room.
- Press the EMERGENCY OPERATION switch once (twice) to start the EMERGENCY COOL (HEAT) MODE.
- When system stabilizes after more than 15 minutes, measure temperature and take an average temperature.
- 10 minutes later, measure temperature again and check that the temperature does not change.

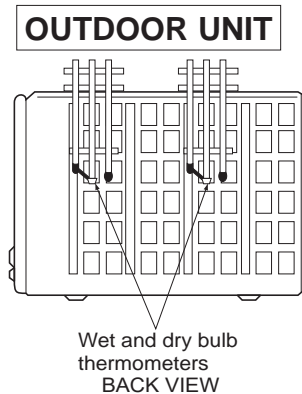
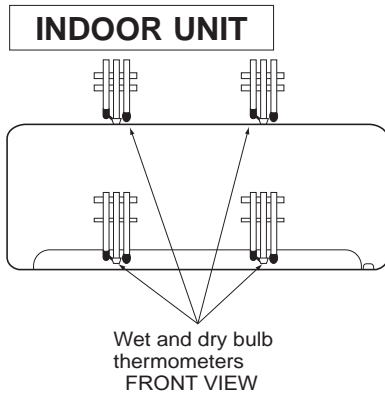

9-1. CAPACITY AND INPUT CURVES

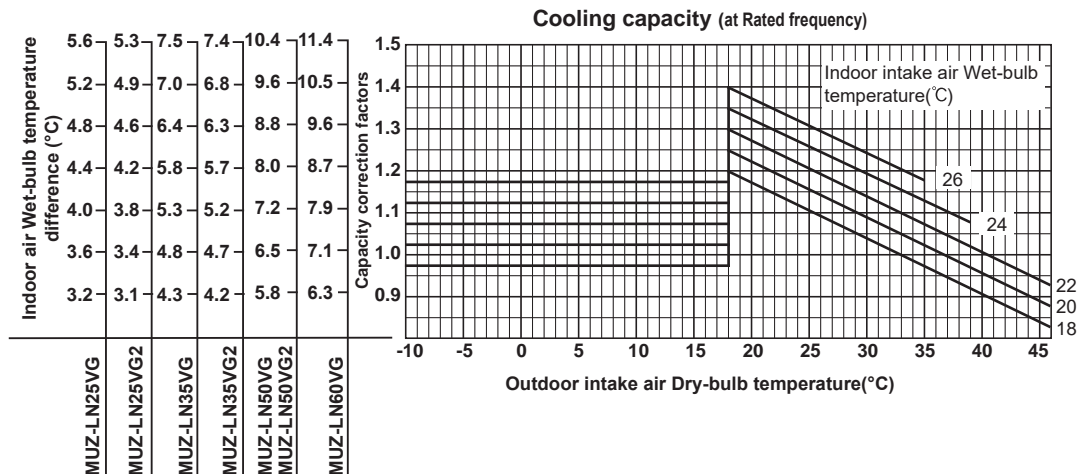

Indoor air Wet-bulb temperature difference (°C)	4.8	4.6	6.4	6.3	8.8	9.6
	4.4	4.2	5.8	5.7	8.0	8.7
	4.0	3.8	5.3	5.2	7.2	7.9
	3.6	3.4	4.8	4.7	6.5	7.1
	3.2	3.1	4.3	4.2	5.8	6.3
	2.8	2.7	3.7	3.7	5.0	5.5
	MUZ-LN25VG	MUZ-LN25VG2	MUZ-LN35VG	MUZ-LN35VG2	MUZ-LN50VG MUZ-LN50VG2	MUZ-LN60VG

Total input (Cooling : at Rated frequency)

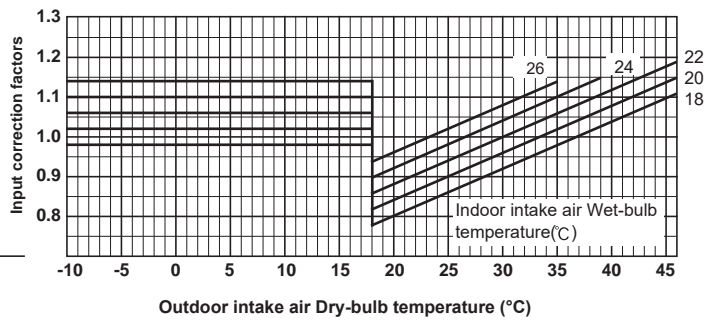

Indoor air Dry-bulb temperature difference (°C)	14.5	15.1	19.1	18.8	25.0	28.3
	13.4	13.9	17.6	17.4	23.1	26.1
	12.3	12.7	16.2	15.9	21.1	24.0
	11.2	11.6	14.7	14.5	19.2	21.8
	10.1	10.4	13.2	13.0	17.3	19.6
	8.9	9.3	11.7	11.6	15.4	17.4
	7.8	8.1	10.3	10.1	13.5	15.3
	6.7	6.9	8.8	8.7	11.5	13.1
	5.6	5.8	7.3	7.2	9.6	10.9
	4.5	4.6	5.9	5.8	7.7	8.7
	MUZ-LN25VG	MUZ-LN25VG2	MUZ-LN35VG	MUZ-LN35VG2	MUZ-LN50VG MUZ-LN50VG2	MUZ-LN60VG

Heating capacity (at Rated frequency)

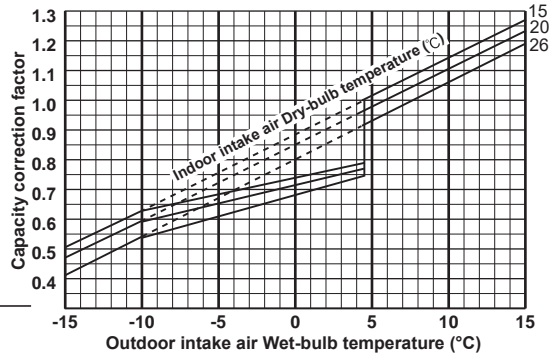

Indoor air Dry-bulb temperature difference (°C)	14.5	15.1	19.1	18.8	25.0	28.3
	13.4	13.9	17.6	17.4	23.1	26.1
	12.3	12.7	16.2	15.9	21.1	24.0
	11.2	11.6	14.7	14.5	19.2	21.8
	10.1	10.4	13.2	13.0	17.3	19.6
	8.9	9.3	11.7	11.6	15.4	17.4
	7.8	8.1	10.3	10.1	13.5	15.3
	6.7	6.9	8.8	8.7	11.5	13.1
	5.6	5.8	7.3	7.2	9.6	10.9
	4.5	4.6	5.9	5.8	7.7	8.7
	MUZ-LN25VG	MUZ-LN25VG2	MUZ-LN35VG	MUZ-LN35VG2	MUZ-LN50VG MUZ-LN50VG2	MUZ-LN60VG

Total input (Heating : at Rated frequency)

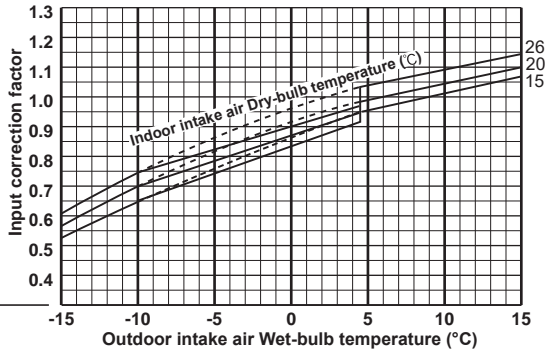

NOTE: The above broken lines are for the heating operation without any frost and defrost operation.

9-2. CAPACITY AND INPUT CORRECTION BY OPERATIONAL FREQUENCY OF COMPRESSOR

MUZ-LN25VG

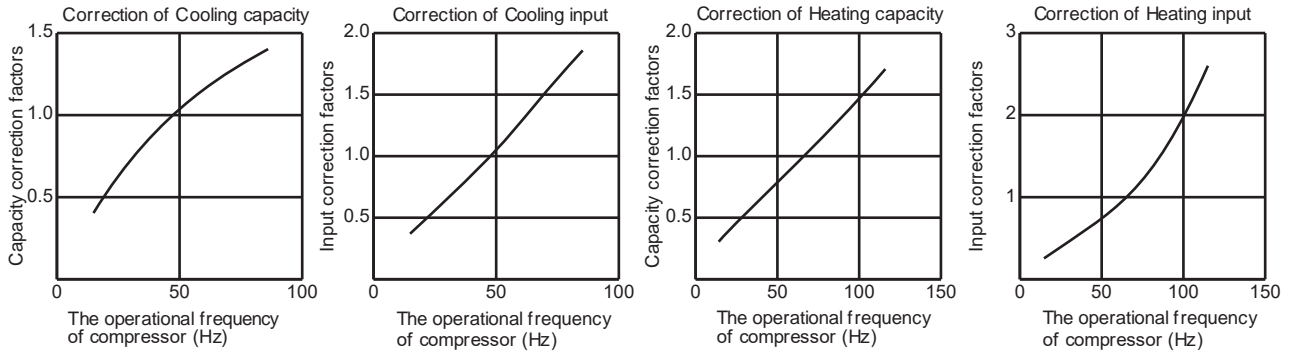

MUZ-LN25VG2

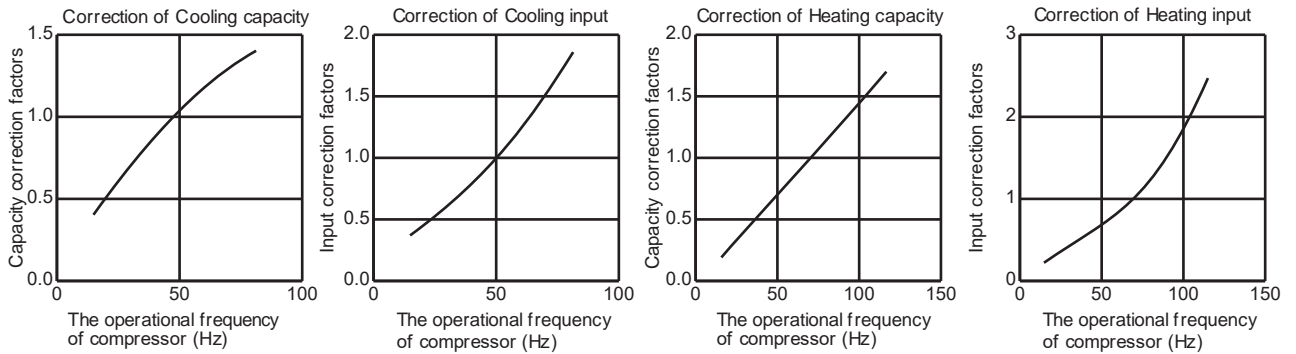

MUZ-LN35VG

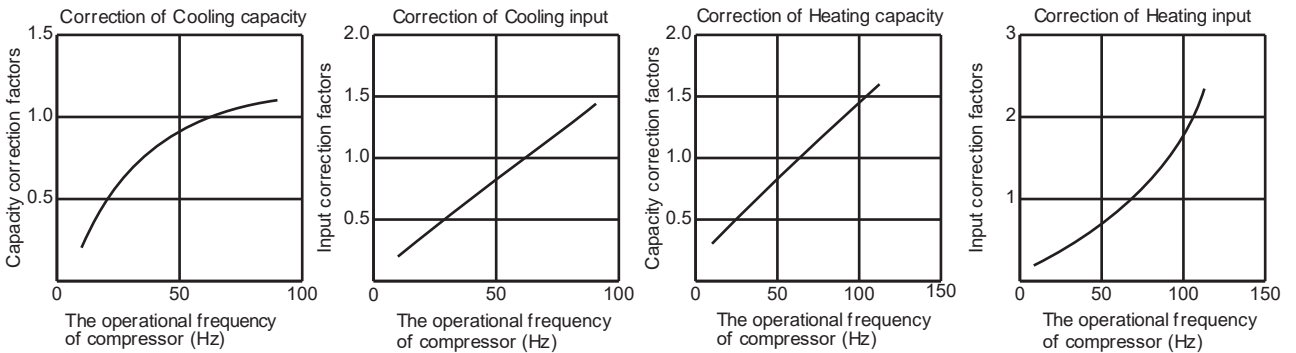

MUZ-LN35VG2

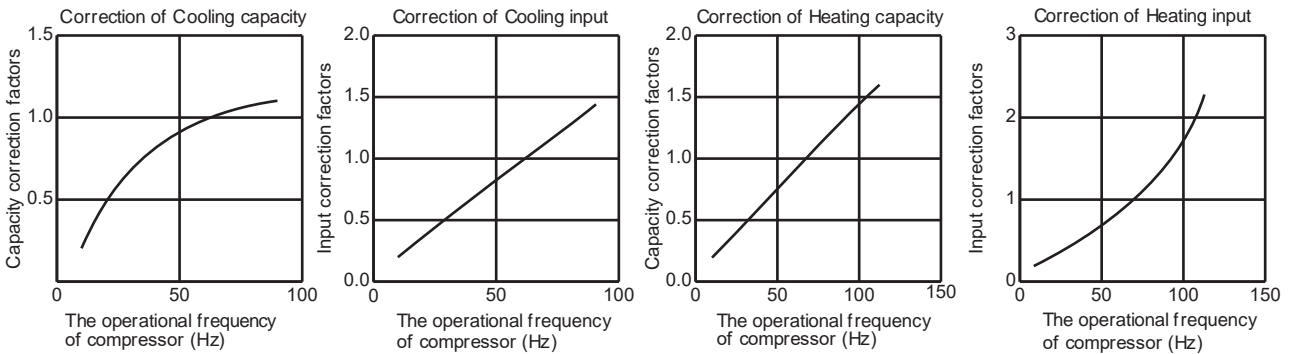

MUZ-LN50VG MUZ-LN50VG2

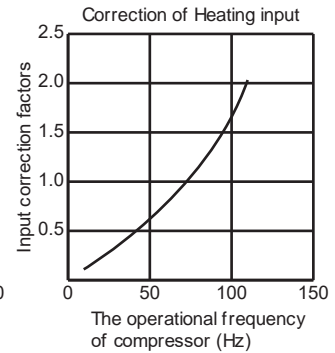
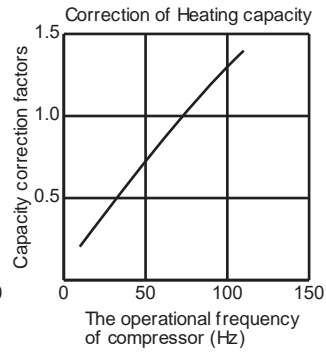
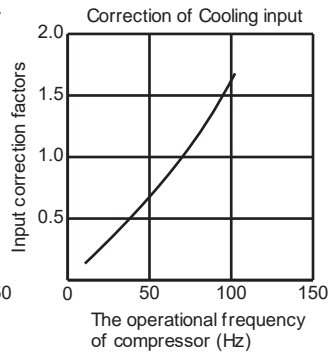
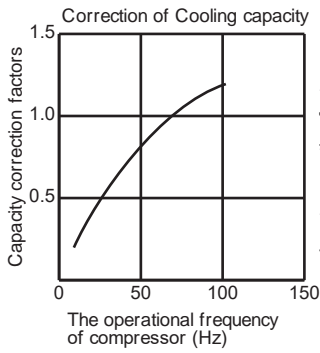

MUZ-LN60VG

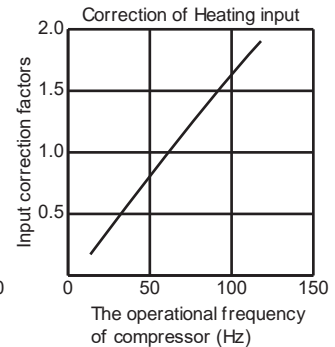
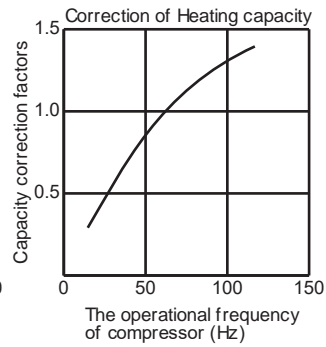
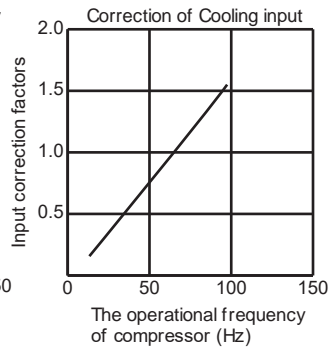
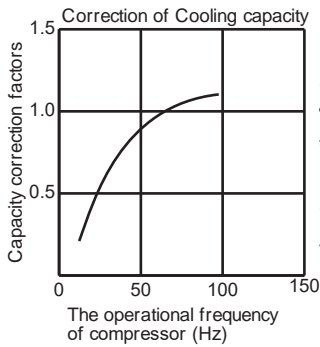

9-3. HOW TO OPERATE FIXED-FREQUENCY OPERATION

<Test run operation>

1. Press EMERGENCY OPERATION switch to start COOL or HEAT mode (COOL: Press once, HEAT: Press twice).
2. Test run operation starts and continues to operate for 30 minutes.
3. Compressor operates at rated frequency in COOL mode or 58 Hz in HEAT mode.
4. Indoor fan operates at High speed.
5. After 30 minutes, test run operation finishes and EMERGENCY OPERATION starts (operation frequency of compressor varies).
6. To cancel test run operation (EMERGENCY OPERATION), press EMERGENCY OPERATION switch or any button on remote controller.

9-4. OUTDOOR LOW PRESSURE AND OUTDOOR UNIT CURRENT COOL operation

- ① Both indoor and outdoor unit are under the same temperature/humidity condition.
- ② Operation: TEST RUN OPERATION (Refer to 8-3.)

Dry-bulb temperature (°C)	Relative humidity (%)
20	50
25	60
30	70

Outdoor low pressure

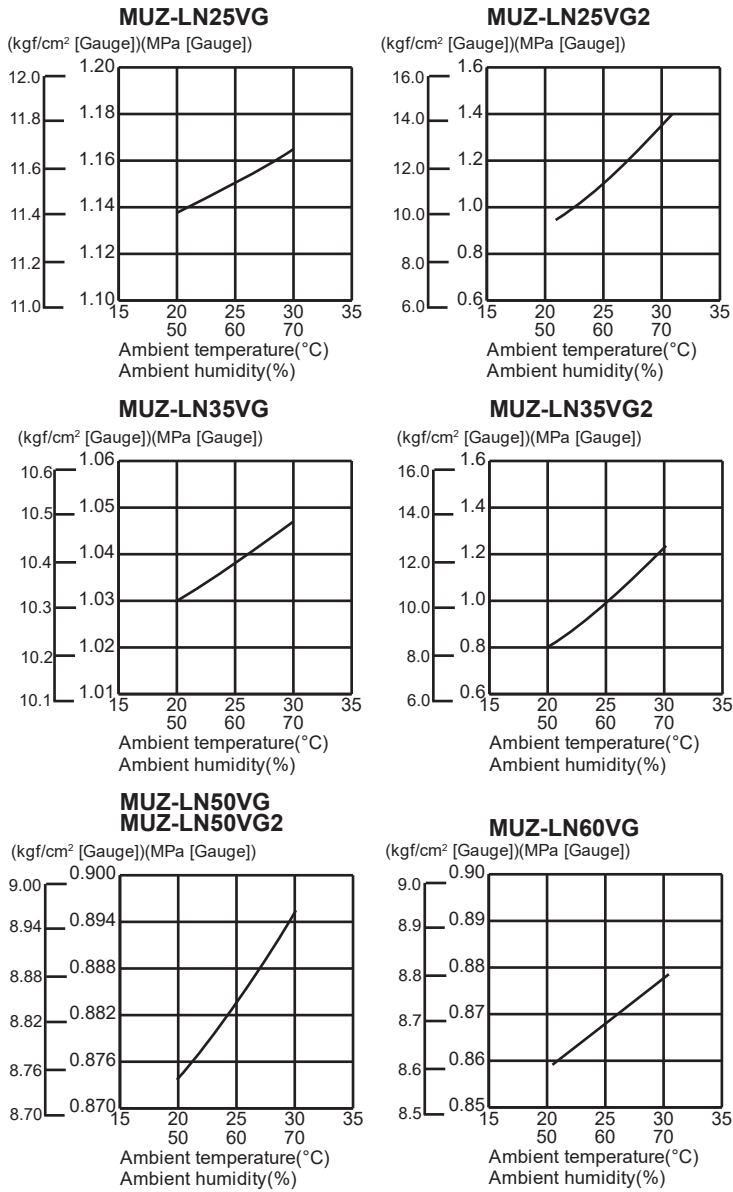

NOTE:

The unit of pressure has been changed to MPa on the international system of units (SI unit system)
The conversion factor is: **1 (MPa [Gauge]) = 10.2 (kgf/cm² [Gauge])**

Outdoor unit current

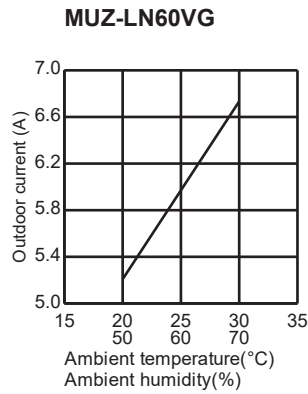
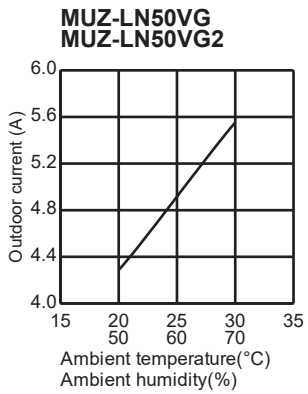
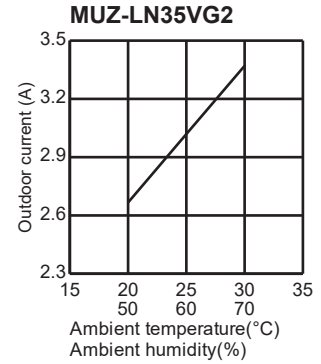
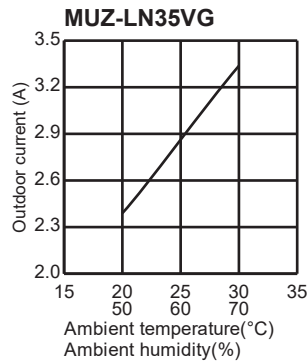
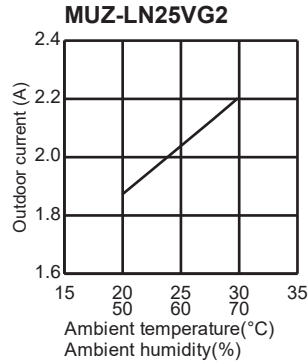
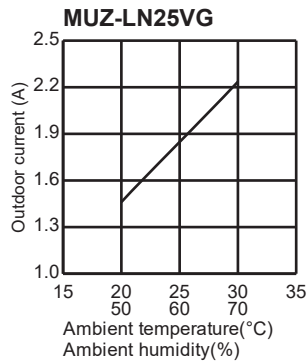

HEAT operation

① Condition:

	Indoor	Outdoor			
Dry bulb temperature (°C)	20.0	2	7	15	20.0
Wet bulb temperature (°C)	14.5	1	6	12	14.5

② Operation: Test run operation (Refer to 8-3.)

Outdoor unit current

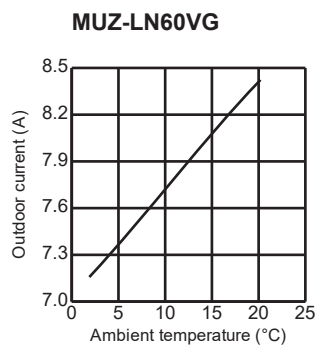
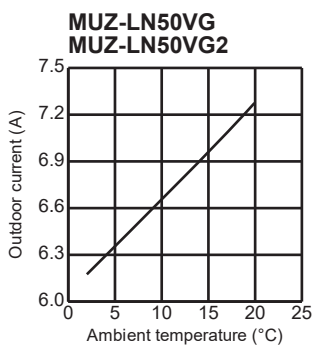
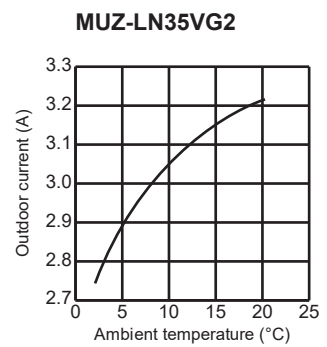
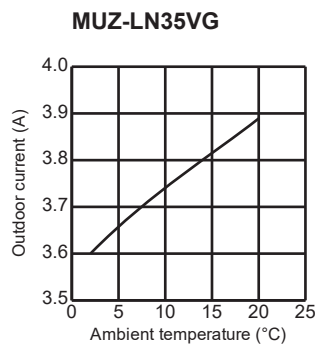
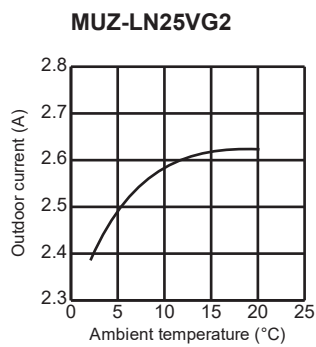
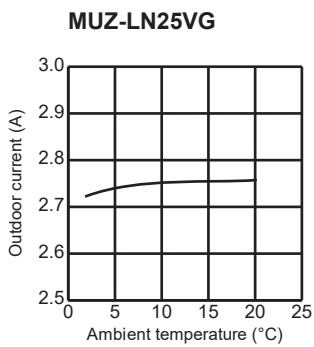

PERFORMANCE DATA COOL operation at Rated frequency

MUZ-LN25VG

CAPACITY: 2.5 kW

SHF: 0.97

INPUT: 485 W

INDOOR DB (°C)	INDOOR WB (°C)	OUTDOOR DB (°C)															
		21				25				27				30			
		Q	SHC	SHF	INPUT	Q	SHC	SHF	INPUT	Q	SHC	SHF	INPUT	Q	SHC	SHF	INPUT
21	18	2.94	2.32	0.79	388	2.81	2.22	0.79	407	2.70	2.13	0.79	427	2.60	2.05	0.79	446
21	20	3.06	2.05	0.67	407	2.94	1.97	0.67	432	2.85	1.91	0.67	441	2.75	1.84	0.67	461
22	18	2.94	2.44	0.83	388	2.81	2.33	0.83	407	2.70	2.24	0.83	427	2.60	2.16	0.83	446
22	20	3.06	2.17	0.71	407	2.94	2.09	0.71	432	2.85	2.02	0.71	441	2.75	1.95	0.71	461
22	22	3.19	1.88	0.59	422	3.08	1.81	0.59	449	3.00	1.77	0.59	461	2.88	1.70	0.59	480
23	18	2.94	2.56	0.87	388	2.81	2.45	0.87	407	2.70	2.35	0.87	427	2.60	2.26	0.87	446
23	20	3.06	2.30	0.75	407	2.94	2.20	0.75	432	2.85	2.14	0.75	441	2.75	2.06	0.75	461
23	22	3.19	2.01	0.63	422	3.08	1.94	0.63	449	3.00	1.89	0.63	461	2.88	1.81	0.63	480
24	18	2.94	2.67	0.91	388	2.81	2.56	0.91	407	2.70	2.46	0.91	427	2.60	2.37	0.91	446
24	20	3.06	2.42	0.79	407	2.94	2.32	0.79	432	2.85	2.25	0.79	441	2.75	2.17	0.79	461
24	22	3.19	2.14	0.67	422	3.08	2.06	0.67	449	3.00	2.01	0.67	461	2.88	1.93	0.67	480
24	24	3.35	1.84	0.55	441	3.23	1.77	0.55	466	3.15	1.73	0.55	480	3.05	1.68	0.55	504
25	18	2.94	2.79	0.95	388	2.81	2.67	0.95	407	2.70	2.57	0.95	427	2.60	2.47	0.95	446
25	20	3.06	2.54	0.83	407	2.94	2.44	0.83	432	2.85	2.37	0.83	441	2.75	2.28	0.83	461
25	22	3.19	2.26	0.71	422	3.08	2.18	0.71	449	3.00	2.13	0.71	461	2.88	2.04	0.71	480
25	24	3.35	1.98	0.59	441	3.23	1.90	0.59	466	3.15	1.86	0.59	480	3.05	1.80	0.59	504
26	18	2.94	2.91	0.99	388	2.81	2.78	0.99	407	2.70	2.67	0.99	427	2.60	2.57	0.99	446
26	20	3.06	2.66	0.87	407	2.94	2.56	0.87	432	2.85	2.48	0.87	441	2.75	2.39	0.87	461
26	22	3.19	2.39	0.75	422	3.08	2.31	0.75	449	3.00	2.25	0.75	461	2.88	2.16	0.75	480
26	24	3.35	2.11	0.63	441	3.23	2.03	0.63	466	3.15	1.98	0.63	480	3.05	1.92	0.63	504
26	26	3.45	1.76	0.51	466	3.35	1.71	0.51	490	3.30	1.68	0.51	504	3.20	1.63	0.51	519
27	18	2.94	2.94	1.00	388	2.81	2.81	1.00	407	2.70	2.70	1.00	427	2.60	2.60	1.00	446
27	20	3.06	2.79	0.91	407	2.94	2.67	0.91	432	2.85	2.59	0.91	441	2.75	2.50	0.91	461
27	22	3.19	2.52	0.79	422	3.08	2.43	0.79	449	3.00	2.37	0.79	461	2.88	2.27	0.79	480
27	24	3.35	2.24	0.67	441	3.23	2.16	0.67	466	3.15	2.11	0.67	480	3.05	2.04	0.67	504
27	26	3.45	1.90	0.55	466	3.35	1.84	0.55	490	3.30	1.82	0.55	504	3.20	1.76	0.55	519
28	18	2.94	2.94	1.00	388	2.81	2.81	1.00	407	2.70	2.70	1.00	427	2.60	2.60	1.00	446
28	20	3.06	2.91	0.95	407	2.94	2.79	0.95	432	2.85	2.71	0.95	441	2.75	2.61	0.95	461
28	22	3.19	2.65	0.83	422	3.08	2.55	0.83	449	3.00	2.49	0.83	461	2.88	2.39	0.83	480
28	24	3.35	2.38	0.71	441	3.23	2.29	0.71	466	3.15	2.24	0.71	480	3.05	2.17	0.71	504
28	26	3.45	2.04	0.59	466	3.35	1.98	0.59	490	3.30	1.95	0.59	504	3.20	1.89	0.59	519
29	18	2.94	2.94	1.00	388	2.81	2.81	1.00	407	2.70	2.70	1.00	427	2.60	2.60	1.00	446
29	20	3.06	3.03	0.99	407	2.94	2.91	0.99	432	2.85	2.82	0.99	441	2.75	2.72	0.99	461
29	22	3.19	2.77	0.87	422	3.08	2.68	0.87	449	3.00	2.61	0.87	461	2.88	2.50	0.87	480
29	24	3.35	2.51	0.75	441	3.23	2.42	0.75	466	3.15	2.36	0.75	480	3.05	2.29	0.75	504
29	26	3.45	2.17	0.63	466	3.35	2.11	0.63	490	3.30	2.08	0.63	504	3.20	2.02	0.63	519
30	18	2.94	2.94	1.00	388	2.81	2.81	1.00	407	2.70	2.70	1.00	427	2.60	2.60	1.00	446
30	20	3.06	3.06	1.00	407	2.94	2.94	1.00	432	2.85	2.85	1.00	441	2.75	2.75	1.00	461
30	22	3.19	2.90	0.91	422	3.08	2.80	0.91	449	3.00	2.73	0.91	461	2.88	2.62	0.91	480
30	24	3.35	2.65	0.79	441	3.23	2.55	0.79	466	3.15	2.49	0.79	480	3.05	2.41	0.79	504
30	26	3.45	2.31	0.67	466	3.35	2.24	0.67	490	3.30	2.21	0.67	504	3.20	2.14	0.67	519
31	18	2.94	2.94	1.00	388	2.81	2.81	1.00	407	2.70	2.70	1.00	427	2.60	2.60	1.00	446
31	20	3.06	3.06	1.00	407	2.94	2.94	1.00	432	2.85	2.85	1.00	441	2.75	2.75	1.00	461
31	22	3.19	3.03	0.95	422	3.08	2.92	0.95	449	3.00	2.85	0.95	461	2.88	2.73	0.95	480
31	24	3.35	2.78	0.83	441	3.23	2.68	0.83	466	3.15	2.61	0.83	480	3.05	2.53	0.83	504
31	26	3.45	2.45	0.71	466	3.35	2.38	0.71	490	3.30	2.34	0.71	504	3.20	2.27	0.71	519
32	18	2.94	2.94	1.00	388	2.81	2.81	1.00	407	2.70	2.70	1.00	427	2.60	2.60	1.00	446
32	20	3.06	3.06	1.00	407	2.94	2.94	1.00	432	2.85	2.85	1.00	441	2.75	2.75	1.00	461
32	22	3.19	3.16	0.99	422	3.08	3.04	0.99	449	3.00	2.97	0.99	461	2.88	2.85	0.99	480
32	24	3.35	2.91	0.87	441	3.23	2.81	0.87	466	3.15	2.74	0.87	480	3.05	2.65	0.87	504
32	26	3.45	2.59	0.75	466	3.35	2.51	0.75	490	3.30	2.48	0.75	504	3.20	2.40	0.75	519

NOTE Q : Total capacity (kW) SHF : Sensible heat factor DB : Dry-bulb temperature
 SHC : Sensible heat capacity (kW) INPUT : Total power input (W) WB : Wet-bulb temperature

PERFORMANCE DATA COOL operation at Rated frequency

MUZ-LN25VG

CAPACITY: 2.5 kW

SHF: 0.97

INPUT: 485 W

INDOOR DB (°C)	INDOOR WB (°C)	OUTDOOR DB (°C)											
		35				40				46			
		Q	SHC	SHF	INPUT	Q	SHC	SHF	INPUT	Q	SHC	SHF	INPUT
21	18	2.45	1.94	0.79	475	2.25	1.78	0.79	504	2.08	1.64	0.79	524
21	20	2.58	1.73	0.67	495	2.40	1.61	0.67	519	2.23	1.49	0.67	548
22	18	2.45	2.03	0.83	475	2.25	1.87	0.83	504	2.08	1.72	0.83	524
22	20	2.58	1.83	0.71	495	2.40	1.70	0.71	519	2.23	1.58	0.71	548
22	22	2.73	1.61	0.59	514	2.55	1.50	0.59	543	2.38	1.40	0.59	563
23	18	2.45	2.13	0.87	475	2.25	1.96	0.87	504	2.08	1.81	0.87	524
23	20	2.58	1.93	0.75	495	2.40	1.80	0.75	519	2.23	1.67	0.75	548
23	22	2.73	1.72	0.63	514	2.55	1.61	0.63	543	2.38	1.50	0.63	563
24	18	2.45	2.23	0.91	475	2.25	2.05	0.91	504	2.08	1.89	0.91	524
24	20	2.58	2.03	0.79	495	2.40	1.90	0.79	519	2.23	1.76	0.79	548
24	22	2.73	1.83	0.67	514	2.55	1.71	0.67	543	2.38	1.59	0.67	563
24	24	2.88	1.58	0.55	534	2.70	1.49	0.55	558	2.55	1.40	0.55	582
25	18	2.45	2.33	0.95	475	2.25	2.14	0.95	504	2.08	1.97	0.95	524
25	20	2.58	2.14	0.83	495	2.40	1.99	0.83	519	2.23	1.85	0.83	548
25	22	2.73	1.93	0.71	514	2.55	1.81	0.71	543	2.38	1.69	0.71	563
25	24	2.88	1.70	0.59	534	2.70	1.59	0.59	558	2.55	1.50	0.59	582
26	18	2.45	2.43	0.99	475	2.25	2.23	0.99	504	2.08	2.05	0.99	524
26	20	2.58	2.24	0.87	495	2.40	2.09	0.87	519	2.23	1.94	0.87	548
26	22	2.73	2.04	0.75	514	2.55	1.91	0.75	543	2.38	1.78	0.75	563
26	24	2.88	1.81	0.63	534	2.70	1.70	0.63	558	2.55	1.61	0.63	582
26	26	3.03	1.54	0.51	553	2.85	1.45	0.51	577	2.68	1.36	0.51	601
27	18	2.45	2.45	1.00	475	2.25	2.25	1.00	504	2.08	2.08	1.00	524
27	20	2.58	2.34	0.91	495	2.40	2.18	0.91	519	2.23	2.02	0.91	548
27	22	2.73	2.15	0.79	514	2.55	2.01	0.79	543	2.38	1.88	0.79	563
27	24	2.88	1.93	0.67	534	2.70	1.81	0.67	558	2.55	1.71	0.67	582
27	26	3.03	1.66	0.55	553	2.85	1.57	0.55	577	2.68	1.47	0.55	601
28	18	2.45	2.45	1.00	475	2.25	2.25	1.00	504	2.08	2.08	1.00	524
28	20	2.58	2.45	0.95	495	2.40	2.28	0.95	519	2.23	2.11	0.95	548
28	22	2.73	2.26	0.83	514	2.55	2.12	0.83	543	2.38	1.97	0.83	563
28	24	2.88	2.04	0.71	534	2.70	1.92	0.71	558	2.55	1.81	0.71	582
28	26	3.03	1.78	0.59	553	2.85	1.68	0.59	577	2.68	1.58	0.59	601
29	18	2.45	2.45	1.00	475	2.25	2.25	1.00	504	2.08	2.08	1.00	524
29	20	2.58	2.55	0.99	495	2.40	2.38	0.99	519	2.23	2.20	0.99	548
29	22	2.73	2.37	0.87	514	2.55	2.22	0.87	543	2.38	2.07	0.87	563
29	24	2.88	2.16	0.75	534	2.70	2.03	0.75	558	2.55	1.91	0.75	582
29	26	3.03	1.91	0.63	553	2.85	1.80	0.63	577	2.68	1.69	0.63	601
30	18	2.45	2.45	1.00	475	2.25	2.25	1.00	504	2.08	2.08	1.00	524
30	20	2.58	2.58	1.00	495	2.40	2.40	1.00	519	2.23	2.23	1.00	548
30	22	2.73	2.48	0.91	514	2.55	2.32	0.91	543	2.38	2.16	0.91	563
30	24	2.88	2.27	0.79	534	2.70	2.13	0.79	558	2.55	2.01	0.79	582
30	26	3.03	2.03	0.67	553	2.85	1.91	0.67	577	2.68	1.79	0.67	601
31	18	2.45	2.45	1.00	475	2.25	2.25	1.00	504	2.08	2.08	1.00	524
31	20	2.58	2.58	1.00	495	2.40	2.40	1.00	519	2.23	2.23	1.00	548
31	22	2.73	2.59	0.95	514	2.55	2.42	0.95	543	2.38	2.26	0.95	563
31	24	2.88	2.39	0.83	534	2.70	2.24	0.83	558	2.55	2.12	0.83	582
31	26	3.03	2.15	0.71	553	2.85	2.02	0.71	577	2.68	1.90	0.71	601
32	18	2.45	2.45	1.00	475	2.25	2.25	1.00	504	2.08	2.08	1.00	524
32	20	2.58	2.58	1.00	495	2.40	2.40	1.00	519	2.23	2.23	1.00	548
32	22	2.73	2.70	0.99	514	2.55	2.52	0.99	543	2.38	2.35	0.99	563
32	24	2.88	2.50	0.87	534	2.70	2.35	0.87	558	2.55	2.22	0.87	582
32	26	3.03	2.27	0.75	553	2.85	2.14	0.75	577	2.68	2.01	0.75	601

NOTE Q : Total capacity (kW) SHF : Sensible heat factor DB : Dry-bulb temperature
 SHC : Sensible heat capacity (kW) INPUT : Total power input (W) WB : Wet-bulb temperature

PERFORMANCE DATA COOL operation at Rated frequency

MUZ-LN25VG2

CAPACITY: 2.5 kW

SHF: 0.97

INPUT: 485 W

INDOOR DB (°C)	INDOOR WB (°C)	OUTDOOR DB (°C)															
		21				25				27				30			
		Q	SHC	SHF	INPUT	Q	SHC	SHF	INPUT	Q	SHC	SHF	INPUT	Q	SHC	SHF	INPUT
21	18	2.94	2.32	0.79	388	2.81	2.22	0.79	407	2.70	2.13	0.79	427	2.60	2.05	0.79	446
21	20	3.06	2.05	0.67	407	2.94	1.97	0.67	432	2.85	1.91	0.67	441	2.75	1.84	0.67	461
22	18	2.94	2.44	0.83	388	2.81	2.33	0.83	407	2.70	2.24	0.83	427	2.60	2.16	0.83	446
22	20	3.06	2.17	0.71	407	2.94	2.09	0.71	432	2.85	2.02	0.71	441	2.75	1.95	0.71	461
22	22	3.19	1.88	0.59	422	3.08	1.81	0.59	449	3.00	1.77	0.59	461	2.88	1.70	0.59	480
23	18	2.94	2.56	0.87	388	2.81	2.45	0.87	407	2.70	2.35	0.87	427	2.60	2.26	0.87	446
23	20	3.06	2.30	0.75	407	2.94	2.20	0.75	432	2.85	2.14	0.75	441	2.75	2.06	0.75	461
23	22	3.19	2.01	0.63	422	3.08	1.94	0.63	449	3.00	1.89	0.63	461	2.88	1.81	0.63	480
24	18	2.94	2.67	0.91	388	2.81	2.56	0.91	407	2.70	2.46	0.91	427	2.60	2.37	0.91	446
24	20	3.06	2.42	0.79	407	2.94	2.32	0.79	432	2.85	2.25	0.79	441	2.75	2.17	0.79	461
24	22	3.19	2.14	0.67	422	3.08	2.06	0.67	449	3.00	2.01	0.67	461	2.88	1.93	0.67	480
24	24	3.35	1.84	0.55	441	3.23	1.77	0.55	466	3.15	1.73	0.55	480	3.05	1.68	0.55	504
25	18	2.94	2.79	0.95	388	2.81	2.67	0.95	407	2.70	2.57	0.95	427	2.60	2.47	0.95	446
25	20	3.06	2.54	0.83	407	2.94	2.44	0.83	432	2.85	2.37	0.83	441	2.75	2.28	0.83	461
25	22	3.19	2.26	0.71	422	3.08	2.18	0.71	449	3.00	2.13	0.71	461	2.88	2.04	0.71	480
25	24	3.35	1.98	0.59	441	3.23	1.90	0.59	466	3.15	1.86	0.59	480	3.05	1.80	0.59	504
26	18	2.94	2.91	0.99	388	2.81	2.78	0.99	407	2.70	2.67	0.99	427	2.60	2.57	0.99	446
26	20	3.06	2.66	0.87	407	2.94	2.56	0.87	432	2.85	2.48	0.87	441	2.75	2.39	0.87	461
26	22	3.19	2.39	0.75	422	3.08	2.31	0.75	449	3.00	2.25	0.75	461	2.88	2.16	0.75	480
26	24	3.35	2.11	0.63	441	3.23	2.03	0.63	466	3.15	1.98	0.63	480	3.05	1.92	0.63	504
26	26	3.45	1.76	0.51	466	3.35	1.71	0.51	490	3.30	1.68	0.51	504	3.20	1.63	0.51	519
27	18	2.94	2.94	1.00	388	2.81	2.81	1.00	407	2.70	2.70	1.00	427	2.60	2.60	1.00	446
27	20	3.06	2.79	0.91	407	2.94	2.67	0.91	432	2.85	2.59	0.91	441	2.75	2.50	0.91	461
27	22	3.19	2.52	0.79	422	3.08	2.43	0.79	449	3.00	2.37	0.79	461	2.88	2.27	0.79	480
27	24	3.35	2.24	0.67	441	3.23	2.16	0.67	466	3.15	2.11	0.67	480	3.05	2.04	0.67	504
27	26	3.45	1.90	0.55	466	3.35	1.84	0.55	490	3.30	1.82	0.55	504	3.20	1.76	0.55	519
28	18	2.94	2.94	1.00	388	2.81	2.81	1.00	407	2.70	2.70	1.00	427	2.60	2.60	1.00	446
28	20	3.06	2.91	0.95	407	2.94	2.79	0.95	432	2.85	2.71	0.95	441	2.75	2.61	0.95	461
28	22	3.19	2.65	0.83	422	3.08	2.55	0.83	449	3.00	2.49	0.83	461	2.88	2.39	0.83	480
28	24	3.35	2.38	0.71	441	3.23	2.29	0.71	466	3.15	2.24	0.71	480	3.05	2.17	0.71	504
28	26	3.45	2.04	0.59	466	3.35	1.98	0.59	490	3.30	1.95	0.59	504	3.20	1.89	0.59	519
29	18	2.94	2.94	1.00	388	2.81	2.81	1.00	407	2.70	2.70	1.00	427	2.60	2.60	1.00	446
29	20	3.06	3.03	0.99	407	2.94	2.91	0.99	432	2.85	2.82	0.99	441	2.75	2.72	0.99	461
29	22	3.19	2.77	0.87	422	3.08	2.68	0.87	449	3.00	2.61	0.87	461	2.88	2.50	0.87	480
29	24	3.35	2.51	0.75	441	3.23	2.42	0.75	466	3.15	2.36	0.75	480	3.05	2.29	0.75	504
29	26	3.45	2.17	0.63	466	3.35	2.11	0.63	490	3.30	2.08	0.63	504	3.20	2.02	0.63	519
30	18	2.94	2.94	1.00	388	2.81	2.81	1.00	407	2.70	2.70	1.00	427	2.60	2.60	1.00	446
30	20	3.06	3.06	1.00	407	2.94	2.94	1.00	432	2.85	2.85	1.00	441	2.75	2.75	1.00	461
30	22	3.19	2.90	0.91	422	3.08	2.80	0.91	449	3.00	2.73	0.91	461	2.88	2.62	0.91	480
30	24	3.35	2.65	0.79	441	3.23	2.55	0.79	466	3.15	2.49	0.79	480	3.05	2.41	0.79	504
30	26	3.45	2.31	0.67	466	3.35	2.24	0.67	490	3.30	2.21	0.67	504	3.20	2.14	0.67	519
31	18	2.94	2.94	1.00	388	2.81	2.81	1.00	407	2.70	2.70	1.00	427	2.60	2.60	1.00	446
31	20	3.06	3.06	1.00	407	2.94	2.94	1.00	432	2.85	2.85	1.00	441	2.75	2.75	1.00	461
31	22	3.19	3.03	0.95	422	3.08	2.92	0.95	449	3.00	2.85	0.95	461	2.88	2.73	0.95	480
31	24	3.35	2.78	0.83	441	3.23	2.68	0.83	466	3.15	2.61	0.83	480	3.05	2.53	0.83	504
31	26	3.45	2.45	0.71	466	3.35	2.38	0.71	490	3.30	2.34	0.71	504	3.20	2.27	0.71	519
32	18	2.94	2.94	1.00	388	2.81	2.81	1.00	407	2.70	2.70	1.00	427	2.60	2.60	1.00	446
32	20	3.06	3.06	1.00	407	2.94	2.94	1.00	432	2.85	2.85	1.00	441	2.75	2.75	1.00	461
32	22	3.19	3.16	0.99	422	3.08	3.04	0.99	449	3.00	2.97	0.99	461	2.88	2.85	0.99	480
32	24	3.35	2.91	0.87	441	3.23	2.81	0.87	466	3.15	2.74	0.87	480	3.05	2.65	0.87	504
32	26	3.45	2.59	0.75	466	3.35	2.51	0.75	490	3.30	2.48	0.75	504	3.20	2.40	0.75	519

NOTE Q : Total capacity (kW) SHF : Sensible heat factor DB : Dry-bulb temperature
 SHC : Sensible heat capacity (kW) INPUT : Total power input (W) WB : Wet-bulb temperature

PERFORMANCE DATA COOL operation at Rated frequency

MUZ-LN25VG2

CAPACITY: 2.5 kW

SHF: 0.97

INPUT: 485 W

INDOOR DB (°C)	INDOOR WB (°C)	OUTDOOR DB (°C)											
		35				40				46			
		Q	SHC	SHF	INPUT	Q	SHC	SHF	INPUT	Q	SHC	SHF	INPUT
21	18	2.45	1.94	0.79	475	2.25	1.78	0.79	504	2.08	1.64	0.79	524
21	20	2.58	1.73	0.67	495	2.40	1.61	0.67	519	2.23	1.49	0.67	548
22	18	2.45	2.03	0.83	475	2.25	1.87	0.83	504	2.08	1.72	0.83	524
22	20	2.58	1.83	0.71	495	2.40	1.70	0.71	519	2.23	1.58	0.71	548
22	22	2.73	1.61	0.59	514	2.55	1.50	0.59	543	2.38	1.40	0.59	563
23	18	2.45	2.13	0.87	475	2.25	1.96	0.87	504	2.08	1.81	0.87	524
23	20	2.58	1.93	0.75	495	2.40	1.80	0.75	519	2.23	1.67	0.75	548
23	22	2.73	1.72	0.63	514	2.55	1.61	0.63	543	2.38	1.50	0.63	563
24	18	2.45	2.23	0.91	475	2.25	2.05	0.91	504	2.08	1.89	0.91	524
24	20	2.58	2.03	0.79	495	2.40	1.90	0.79	519	2.23	1.76	0.79	548
24	22	2.73	1.83	0.67	514	2.55	1.71	0.67	543	2.38	1.59	0.67	563
24	24	2.88	1.58	0.55	534	2.70	1.49	0.55	558	2.55	1.40	0.55	582
25	18	2.45	2.33	0.95	475	2.25	2.14	0.95	504	2.08	1.97	0.95	524
25	20	2.58	2.14	0.83	495	2.40	1.99	0.83	519	2.23	1.85	0.83	548
25	22	2.73	1.93	0.71	514	2.55	1.81	0.71	543	2.38	1.69	0.71	563
25	24	2.88	1.70	0.59	534	2.70	1.59	0.59	558	2.55	1.50	0.59	582
26	18	2.45	2.43	0.99	475	2.25	2.23	0.99	504	2.08	2.05	0.99	524
26	20	2.58	2.24	0.87	495	2.40	2.09	0.87	519	2.23	1.94	0.87	548
26	22	2.73	2.04	0.75	514	2.55	1.91	0.75	543	2.38	1.78	0.75	563
26	24	2.88	1.81	0.63	534	2.70	1.70	0.63	558	2.55	1.61	0.63	582
26	26	3.03	1.54	0.51	553	2.85	1.45	0.51	577	2.68	1.36	0.51	601
27	18	2.45	2.45	1.00	475	2.25	2.25	1.00	504	2.08	2.08	1.00	524
27	20	2.58	2.34	0.91	495	2.40	2.18	0.91	519	2.23	2.02	0.91	548
27	22	2.73	2.15	0.79	514	2.55	2.01	0.79	543	2.38	1.88	0.79	563
27	24	2.88	1.93	0.67	534	2.70	1.81	0.67	558	2.55	1.71	0.67	582
27	26	3.03	1.66	0.55	553	2.85	1.57	0.55	577	2.68	1.47	0.55	601
28	18	2.45	2.45	1.00	475	2.25	2.25	1.00	504	2.08	2.08	1.00	524
28	20	2.58	2.45	0.95	495	2.40	2.28	0.95	519	2.23	2.11	0.95	548
28	22	2.73	2.26	0.83	514	2.55	2.12	0.83	543	2.38	1.97	0.83	563
28	24	2.88	2.04	0.71	534	2.70	1.92	0.71	558	2.55	1.81	0.71	582
28	26	3.03	1.78	0.59	553	2.85	1.68	0.59	577	2.68	1.58	0.59	601
29	18	2.45	2.45	1.00	475	2.25	2.25	1.00	504	2.08	2.08	1.00	524
29	20	2.58	2.55	0.99	495	2.40	2.38	0.99	519	2.23	2.20	0.99	548
29	22	2.73	2.37	0.87	514	2.55	2.22	0.87	543	2.38	2.07	0.87	563
29	24	2.88	2.16	0.75	534	2.70	2.03	0.75	558	2.55	1.91	0.75	582
29	26	3.03	1.91	0.63	553	2.85	1.80	0.63	577	2.68	1.69	0.63	601
30	18	2.45	2.45	1.00	475	2.25	2.25	1.00	504	2.08	2.08	1.00	524
30	20	2.58	2.58	1.00	495	2.40	2.40	1.00	519	2.23	2.23	1.00	548
30	22	2.73	2.48	0.91	514	2.55	2.32	0.91	543	2.38	2.16	0.91	563
30	24	2.88	2.27	0.79	534	2.70	2.13	0.79	558	2.55	2.01	0.79	582
30	26	3.03	2.03	0.67	553	2.85	1.91	0.67	577	2.68	1.79	0.67	601
31	18	2.45	2.45	1.00	475	2.25	2.25	1.00	504	2.08	2.08	1.00	524
31	20	2.58	2.58	1.00	495	2.40	2.40	1.00	519	2.23	2.23	1.00	548
31	22	2.73	2.59	0.95	514	2.55	2.42	0.95	543	2.38	2.26	0.95	563
31	24	2.88	2.39	0.83	534	2.70	2.24	0.83	558	2.55	2.12	0.83	582
31	26	3.03	2.15	0.71	553	2.85	2.02	0.71	577	2.68	1.90	0.71	601
32	18	2.45	2.45	1.00	475	2.25	2.25	1.00	504	2.08	2.08	1.00	524
32	20	2.58	2.58	1.00	495	2.40	2.40	1.00	519	2.23	2.23	1.00	548
32	22	2.73	2.70	0.99	514	2.55	2.52	0.99	543	2.38	2.35	0.99	563
32	24	2.88	2.50	0.87	534	2.70	2.35	0.87	558	2.55	2.22	0.87	582
32	26	3.03	2.27	0.75	553	2.85	2.14	0.75	577	2.68	2.01	0.75	601

NOTE Q : Total capacity (kW) SHF : Sensible heat factor DB : Dry-bulb temperature
 SHC : Sensible heat capacity (kW) INPUT : Total power input (W) WB : Wet-bulb temperature

PERFORMANCE DATA COOL operation at Rated frequency

MUZ-LN35VG

CAPACITY: 3.5 kW

SHF: 0.90

INPUT: 820 W

INDOOR DB (°C)	INDOOR WB (°C)	OUTDOOR DB (°C)															
		21				25				27				30			
		Q	SHC	SHF	INPUT	Q	SHC	SHF	INPUT	Q	SHC	SHF	INPUT	Q	SHC	SHF	INPUT
21	18	4.11	2.96	0.72	656	3.94	2.84	0.72	689	3.78	2.72	0.72	722	3.64	2.62	0.72	754
21	20	4.29	2.57	0.60	689	4.11	2.47	0.60	730	3.99	2.39	0.60	746	3.85	2.31	0.60	779
22	18	4.11	3.13	0.76	656	3.94	2.99	0.76	689	3.78	2.87	0.76	722	3.64	2.77	0.76	754
22	20	4.29	2.74	0.64	689	4.11	2.63	0.64	730	3.99	2.55	0.64	746	3.85	2.46	0.64	779
22	22	4.46	2.32	0.52	713	4.31	2.24	0.52	759	4.20	2.18	0.52	779	4.03	2.09	0.52	812
23	18	4.11	3.29	0.80	656	3.94	3.15	0.80	689	3.78	3.02	0.80	722	3.64	2.91	0.80	754
23	20	4.29	2.92	0.68	689	4.11	2.80	0.68	730	3.99	2.71	0.68	746	3.85	2.62	0.68	779
23	22	4.46	2.50	0.56	713	4.31	2.41	0.56	759	4.20	2.35	0.56	779	4.03	2.25	0.56	812
24	18	4.11	3.45	0.84	656	3.94	3.31	0.84	689	3.78	3.18	0.84	722	3.64	3.06	0.84	754
24	20	4.29	3.09	0.72	689	4.11	2.96	0.72	730	3.99	2.87	0.72	746	3.85	2.77	0.72	779
24	22	4.46	2.68	0.60	713	4.31	2.58	0.60	759	4.20	2.52	0.60	779	4.03	2.42	0.60	812
24	24	4.69	2.25	0.48	746	4.52	2.17	0.48	787	4.41	2.12	0.48	812	4.27	2.05	0.48	853
25	18	4.11	3.62	0.88	656	3.94	3.47	0.88	689	3.78	3.33	0.88	722	3.64	3.20	0.88	754
25	20	4.29	3.26	0.76	689	4.11	3.13	0.76	730	3.99	3.03	0.76	746	3.85	2.93	0.76	779
25	22	4.46	2.86	0.64	713	4.31	2.76	0.64	759	4.20	2.69	0.64	779	4.03	2.58	0.64	812
25	24	4.69	2.44	0.52	746	4.52	2.35	0.52	787	4.41	2.29	0.52	812	4.27	2.22	0.52	853
26	18	4.11	3.78	0.92	656	3.94	3.62	0.92	689	3.78	3.48	0.92	722	3.64	3.35	0.92	754
26	20	4.29	3.43	0.80	689	4.11	3.29	0.80	730	3.99	3.19	0.80	746	3.85	3.08	0.80	779
26	22	4.46	3.03	0.68	713	4.31	2.93	0.68	759	4.20	2.86	0.68	779	4.03	2.74	0.68	812
26	24	4.69	2.63	0.56	746	4.52	2.53	0.56	787	4.41	2.47	0.56	812	4.27	2.39	0.56	853
26	26	4.83	2.13	0.44	787	4.69	2.06	0.44	828	4.62	2.03	0.44	853	4.48	1.97	0.44	877
27	18	4.11	3.95	0.96	656	3.94	3.78	0.96	689	3.78	3.63	0.96	722	3.64	3.49	0.96	754
27	20	4.29	3.60	0.84	689	4.11	3.45	0.84	730	3.99	3.35	0.84	746	3.85	3.23	0.84	779
27	22	4.46	3.21	0.72	713	4.31	3.10	0.72	759	4.20	3.02	0.72	779	4.03	2.90	0.72	812
27	24	4.69	2.81	0.60	746	4.52	2.71	0.60	787	4.41	2.65	0.60	812	4.27	2.56	0.60	853
27	26	4.83	2.32	0.48	787	4.69	2.25	0.48	828	4.62	2.22	0.48	853	4.48	2.15	0.48	877
28	18	4.11	4.11	1.00	656	3.94	3.94	1.00	689	3.78	3.78	1.00	722	3.64	3.64	1.00	754
28	20	4.29	3.77	0.88	689	4.11	3.62	0.88	730	3.99	3.51	0.88	746	3.85	3.39	0.88	779
28	22	4.46	3.39	0.76	713	4.31	3.27	0.76	759	4.20	3.19	0.76	779	4.03	3.06	0.76	812
28	24	4.69	3.00	0.64	746	4.52	2.89	0.64	787	4.41	2.82	0.64	812	4.27	2.73	0.64	853
28	26	4.83	2.51	0.52	787	4.69	2.44	0.52	828	4.62	2.40	0.52	853	4.48	2.33	0.52	877
29	18	4.11	4.11	1.00	656	3.94	3.94	1.00	689	3.78	3.78	1.00	722	3.64	3.64	1.00	754
29	20	4.29	3.94	0.92	689	4.11	3.78	0.92	730	3.99	3.67	0.92	746	3.85	3.54	0.92	779
29	22	4.46	3.57	0.80	713	4.31	3.44	0.80	759	4.20	3.36	0.80	779	4.03	3.22	0.80	812
29	24	4.69	3.19	0.68	746	4.52	3.07	0.68	787	4.41	3.00	0.68	812	4.27	2.90	0.68	853
29	26	4.83	2.70	0.56	787	4.69	2.63	0.56	828	4.62	2.59	0.56	853	4.48	2.51	0.56	877
30	18	4.11	4.11	1.00	656	3.94	3.94	1.00	689	3.78	3.78	1.00	722	3.64	3.64	1.00	754
30	20	4.29	4.12	0.96	689	4.11	3.95	0.96	730	3.99	3.83	0.96	746	3.85	3.70	0.96	779
30	22	4.46	3.75	0.84	713	4.31	3.62	0.84	759	4.20	3.53	0.84	779	4.03	3.38	0.84	812
30	24	4.69	3.38	0.72	746	4.52	3.25	0.72	787	4.41	3.18	0.72	812	4.27	3.07	0.72	853
30	26	4.83	2.90	0.60	787	4.69	2.81	0.60	828	4.62	2.77	0.60	853	4.48	2.69	0.60	877
31	18	4.11	4.11	1.00	656	3.94	3.94	1.00	689	3.78	3.78	1.00	722	3.64	3.64	1.00	754
31	20	4.29	4.29	1.00	689	4.11	4.11	1.00	730	3.99	3.99	1.00	746	3.85	3.85	1.00	779
31	22	4.46	3.93	0.88	713	4.31	3.79	0.88	759	4.20	3.70	0.88	779	4.03	3.54	0.88	812
31	24	4.69	3.56	0.76	746	4.52	3.43	0.76	787	4.41	3.35	0.76	812	4.27	3.25	0.76	853
31	26	4.83	3.09	0.64	787	4.69	3.00	0.64	828	4.62	2.96	0.64	853	4.48	2.87	0.64	877
32	18	4.11	4.11	1.00	656	3.94	3.94	1.00	689	3.78	3.78	1.00	722	3.64	3.64	1.00	754
32	20	4.29	4.29	1.00	689	4.11	4.11	1.00	730	3.99	3.99	1.00	746	3.85	3.85	1.00	779
32	22	4.46	4.11	0.92	713	4.31	3.96	0.92	759	4.20	3.86	0.92	779	4.03	3.70	0.92	812
32	24	4.69	3.75	0.80	746	4.52	3.61	0.80	787	4.41	3.53	0.80	812	4.27	3.42	0.80	853
32	26	4.83	3.28	0.68	787	4.69	3.19	0.68	828	4.62	3.14	0.68	853	4.48	3.05	0.68	877

NOTE Q : Total capacity (kW) SHF : Sensible heat factor DB : Dry-bulb temperature
 SHC : Sensible heat capacity (kW) INPUT : Total power input (W) WB : Wet-bulb temperature

PERFORMANCE DATA COOL operation at Rated frequency

MUZ-LN35VG

CAPACITY: 3.5 kW

SHF: 0.90

INPUT: 820 W

INDOOR DB (°C)	INDOOR WB (°C)	OUTDOOR DB (°C)											
		35				40				46			
		Q	SHC	SHF	INPUT	Q	SHC	SHF	INPUT	Q	SHC	SHF	INPUT
21	18	3.43	2.47	0.72	804	3.15	2.27	0.72	853	2.91	2.09	0.72	886
21	20	3.61	2.16	0.60	836	3.36	2.02	0.60	877	3.12	1.87	0.60	927
22	18	3.43	2.61	0.76	804	3.15	2.39	0.76	853	2.91	2.21	0.76	886
22	20	3.61	2.31	0.64	836	3.36	2.15	0.64	877	3.12	1.99	0.64	927
22	22	3.82	1.98	0.52	869	3.57	1.86	0.52	918	3.33	1.73	0.52	951
23	18	3.43	2.74	0.80	804	3.15	2.52	0.80	853	2.91	2.32	0.80	886
23	20	3.61	2.45	0.68	836	3.36	2.28	0.68	877	3.12	2.12	0.68	927
23	22	3.82	2.14	0.56	869	3.57	2.00	0.56	918	3.33	1.86	0.56	951
24	18	3.43	2.88	0.84	804	3.15	2.65	0.84	853	2.91	2.44	0.84	886
24	20	3.61	2.60	0.72	836	3.36	2.42	0.72	877	3.12	2.24	0.72	927
24	22	3.82	2.29	0.60	869	3.57	2.14	0.60	918	3.33	2.00	0.60	951
24	24	4.03	1.93	0.48	902	3.78	1.81	0.48	943	3.57	1.71	0.48	984
25	18	3.43	3.02	0.88	804	3.15	2.77	0.88	853	2.91	2.56	0.88	886
25	20	3.61	2.74	0.76	836	3.36	2.55	0.76	877	3.12	2.37	0.76	927
25	22	3.82	2.44	0.64	869	3.57	2.28	0.64	918	3.33	2.13	0.64	951
25	24	4.03	2.09	0.52	902	3.78	1.97	0.52	943	3.57	1.86	0.52	984
26	18	3.43	3.16	0.92	804	3.15	2.90	0.92	853	2.91	2.67	0.92	886
26	20	3.61	2.88	0.80	836	3.36	2.69	0.80	877	3.12	2.49	0.80	927
26	22	3.82	2.59	0.68	869	3.57	2.43	0.68	918	3.33	2.26	0.68	951
26	24	4.03	2.25	0.56	902	3.78	2.12	0.56	943	3.57	2.00	0.56	984
26	26	4.24	1.86	0.44	935	3.99	1.76	0.44	976	3.75	1.65	0.44	1017
27	18	3.43	3.29	0.96	804	3.15	3.02	0.96	853	2.91	2.79	0.96	886
27	20	3.61	3.03	0.84	836	3.36	2.82	0.84	877	3.12	2.62	0.84	927
27	22	3.82	2.75	0.72	869	3.57	2.57	0.72	918	3.33	2.39	0.72	951
27	24	4.03	2.42	0.60	902	3.78	2.27	0.60	943	3.57	2.14	0.60	984
27	26	4.24	2.03	0.48	935	3.99	1.92	0.48	976	3.75	1.80	0.48	1017
28	18	3.43	3.43	1.00	804	3.15	3.15	1.00	853	2.91	2.91	1.00	886
28	20	3.61	3.17	0.88	836	3.36	2.96	0.88	877	3.12	2.74	0.88	927
28	22	3.82	2.90	0.76	869	3.57	2.71	0.76	918	3.33	2.53	0.76	951
28	24	4.03	2.58	0.64	902	3.78	2.42	0.64	943	3.57	2.28	0.64	984
28	26	4.24	2.20	0.52	935	3.99	2.07	0.52	976	3.75	1.95	0.52	1017
29	18	3.43	3.43	1.00	804	3.15	3.15	1.00	853	2.91	2.91	1.00	886
29	20	3.61	3.32	0.92	836	3.36	3.09	0.92	877	3.12	2.87	0.92	927
29	22	3.82	3.05	0.80	869	3.57	2.86	0.80	918	3.33	2.66	0.80	951
29	24	4.03	2.74	0.68	902	3.78	2.57	0.68	943	3.57	2.43	0.68	984
29	26	4.24	2.37	0.56	935	3.99	2.23	0.56	976	3.75	2.10	0.56	1017
30	18	3.43	3.43	1.00	804	3.15	3.15	1.00	853	2.91	2.91	1.00	886
30	20	3.61	3.46	0.96	836	3.36	3.23	0.96	877	3.12	2.99	0.96	927
30	22	3.82	3.20	0.84	869	3.57	3.00	0.84	918	3.33	2.79	0.84	951
30	24	4.03	2.90	0.72	902	3.78	2.72	0.72	943	3.57	2.57	0.72	984
30	26	4.24	2.54	0.60	935	3.99	2.39	0.60	976	3.75	2.25	0.60	1017
31	18	3.43	3.43	1.00	804	3.15	3.15	1.00	853	2.91	2.91	1.00	886
31	20	3.61	3.61	1.00	836	3.36	3.36	1.00	877	3.12	3.12	1.00	927
31	22	3.82	3.36	0.88	869	3.57	3.14	0.88	918	3.33	2.93	0.88	951
31	24	4.03	3.06	0.76	902	3.78	2.87	0.76	943	3.57	2.71	0.76	984
31	26	4.24	2.71	0.64	935	3.99	2.55	0.64	976	3.75	2.40	0.64	1017
32	18	3.43	3.43	1.00	804	3.15	3.15	1.00	853	2.91	2.91	1.00	886
32	20	3.61	3.61	1.00	836	3.36	3.36	1.00	877	3.12	3.12	1.00	927
32	22	3.82	3.51	0.92	869	3.57	3.28	0.92	918	3.33	3.06	0.92	951
32	24	4.03	3.22	0.80	902	3.78	3.02	0.80	943	3.57	2.86	0.80	984
32	26	4.24	2.88	0.68	935	3.99	2.71	0.68	976	3.75	2.55	0.68	1017

NOTE Q : Total capacity (kW) SHF : Sensible heat factor DB : Dry-bulb temperature
 SHC : Sensible heat capacity (kW) INPUT : Total power input (W) WB : Wet-bulb temperature

PERFORMANCE DATA COOL operation at Rated frequency

MUZ-LN35VG2

CAPACITY: 3.5 kW

SHF: 0.90

INPUT: 820 W

INDOOR DB (°C)	INDOOR WB (°C)	OUTDOOR DB (°C)															
		21				25				27				30			
		Q	SHC	SHF	INPUT	Q	SHC	SHF	INPUT	Q	SHC	SHF	INPUT	Q	SHC	SHF	INPUT
21	18	4.11	2.96	0.72	656	3.94	2.84	0.72	689	3.78	2.72	0.72	722	3.64	2.62	0.72	754
21	20	4.29	2.57	0.60	689	4.11	2.47	0.60	730	3.99	2.39	0.60	746	3.85	2.31	0.60	779
22	18	4.11	3.13	0.76	656	3.94	2.99	0.76	689	3.78	2.87	0.76	722	3.64	2.77	0.76	754
22	20	4.29	2.74	0.64	689	4.11	2.63	0.64	730	3.99	2.55	0.64	746	3.85	2.46	0.64	779
22	22	4.46	2.32	0.52	713	4.31	2.24	0.52	759	4.20	2.18	0.52	779	4.03	2.09	0.52	812
23	18	4.11	3.29	0.80	656	3.94	3.15	0.80	689	3.78	3.02	0.80	722	3.64	2.91	0.80	754
23	20	4.29	2.92	0.68	689	4.11	2.80	0.68	730	3.99	2.71	0.68	746	3.85	2.62	0.68	779
23	22	4.46	2.50	0.56	713	4.31	2.41	0.56	759	4.20	2.35	0.56	779	4.03	2.25	0.56	812
24	18	4.11	3.45	0.84	656	3.94	3.31	0.84	689	3.78	3.18	0.84	722	3.64	3.06	0.84	754
24	20	4.29	3.09	0.72	689	4.11	2.96	0.72	730	3.99	2.87	0.72	746	3.85	2.77	0.72	779
24	22	4.46	2.68	0.60	713	4.31	2.58	0.60	759	4.20	2.52	0.60	779	4.03	2.42	0.60	812
24	24	4.69	2.25	0.48	746	4.52	2.17	0.48	787	4.41	2.12	0.48	812	4.27	2.05	0.48	853
25	18	4.11	3.62	0.88	656	3.94	3.47	0.88	689	3.78	3.33	0.88	722	3.64	3.20	0.88	754
25	20	4.29	3.26	0.76	689	4.11	3.13	0.76	730	3.99	3.03	0.76	746	3.85	2.93	0.76	779
25	22	4.46	2.86	0.64	713	4.31	2.76	0.64	759	4.20	2.69	0.64	779	4.03	2.58	0.64	812
25	24	4.69	2.44	0.52	746	4.52	2.35	0.52	787	4.41	2.29	0.52	812	4.27	2.22	0.52	853
26	18	4.11	3.78	0.92	656	3.94	3.62	0.92	689	3.78	3.48	0.92	722	3.64	3.35	0.92	754
26	20	4.29	3.43	0.80	689	4.11	3.29	0.80	730	3.99	3.19	0.80	746	3.85	3.08	0.80	779
26	22	4.46	3.03	0.68	713	4.31	2.93	0.68	759	4.20	2.86	0.68	779	4.03	2.74	0.68	812
26	24	4.69	2.63	0.56	746	4.52	2.53	0.56	787	4.41	2.47	0.56	812	4.27	2.39	0.56	853
26	26	4.83	2.13	0.44	787	4.69	2.06	0.44	828	4.62	2.03	0.44	853	4.48	1.97	0.44	877
27	18	4.11	3.95	0.96	656	3.94	3.78	0.96	689	3.78	3.63	0.96	722	3.64	3.49	0.96	754
27	20	4.29	3.60	0.84	689	4.11	3.45	0.84	730	3.99	3.35	0.84	746	3.85	3.23	0.84	779
27	22	4.46	3.21	0.72	713	4.31	3.10	0.72	759	4.20	3.02	0.72	779	4.03	2.90	0.72	812
27	24	4.69	2.81	0.60	746	4.52	2.71	0.60	787	4.41	2.65	0.60	812	4.27	2.56	0.60	853
27	26	4.83	2.32	0.48	787	4.69	2.25	0.48	828	4.62	2.22	0.48	853	4.48	2.15	0.48	877
28	18	4.11	4.11	1.00	656	3.94	3.94	1.00	689	3.78	3.78	1.00	722	3.64	3.64	1.00	754
28	20	4.29	3.77	0.88	689	4.11	3.62	0.88	730	3.99	3.51	0.88	746	3.85	3.39	0.88	779
28	22	4.46	3.39	0.76	713	4.31	3.27	0.76	759	4.20	3.19	0.76	779	4.03	3.06	0.76	812
28	24	4.69	3.00	0.64	746	4.52	2.89	0.64	787	4.41	2.82	0.64	812	4.27	2.73	0.64	853
28	26	4.83	2.51	0.52	787	4.69	2.44	0.52	828	4.62	2.40	0.52	853	4.48	2.33	0.52	877
29	18	4.11	4.11	1.00	656	3.94	3.94	1.00	689	3.78	3.78	1.00	722	3.64	3.64	1.00	754
29	20	4.29	3.94	0.92	689	4.11	3.78	0.92	730	3.99	3.67	0.92	746	3.85	3.54	0.92	779
29	22	4.46	3.57	0.80	713	4.31	3.44	0.80	759	4.20	3.36	0.80	779	4.03	3.22	0.80	812
29	24	4.69	3.19	0.68	746	4.52	3.07	0.68	787	4.41	3.00	0.68	812	4.27	2.90	0.68	853
29	26	4.83	2.70	0.56	787	4.69	2.63	0.56	828	4.62	2.59	0.56	853	4.48	2.51	0.56	877
30	18	4.11	4.11	1.00	656	3.94	3.94	1.00	689	3.78	3.78	1.00	722	3.64	3.64	1.00	754
30	20	4.29	4.12	0.96	689	4.11	3.95	0.96	730	3.99	3.83	0.96	746	3.85	3.70	0.96	779
30	22	4.46	3.75	0.84	713	4.31	3.62	0.84	759	4.20	3.53	0.84	779	4.03	3.38	0.84	812
30	24	4.69	3.38	0.72	746	4.52	3.25	0.72	787	4.41	3.18	0.72	812	4.27	3.07	0.72	853
30	26	4.83	2.90	0.60	787	4.69	2.81	0.60	828	4.62	2.77	0.60	853	4.48	2.69	0.60	877
31	18	4.11	4.11	1.00	656	3.94	3.94	1.00	689	3.78	3.78	1.00	722	3.64	3.64	1.00	754
31	20	4.29	4.29	1.00	689	4.11	4.11	1.00	730	3.99	3.99	1.00	746	3.85	3.85	1.00	779
31	22	4.46	3.93	0.88	713	4.31	3.79	0.88	759	4.20	3.70	0.88	779	4.03	3.54	0.88	812
31	24	4.69	3.56	0.76	746	4.52	3.43	0.76	787	4.41	3.35	0.76	812	4.27	3.25	0.76	853
31	26	4.83	3.09	0.64	787	4.69	3.00	0.64	828	4.62	2.96	0.64	853	4.48	2.87	0.64	877
32	18	4.11	4.11	1.00	656	3.94	3.94	1.00	689	3.78	3.78	1.00	722	3.64	3.64	1.00	754
32	20	4.29	4.29	1.00	689	4.11	4.11	1.00	730	3.99	3.99	1.00	746	3.85	3.85	1.00	779
32	22	4.46	4.11	0.92	713	4.31	3.96	0.92	759	4.20	3.86	0.92	779	4.03	3.70	0.92	812
32	24	4.69	3.75	0.80	746	4.52	3.61	0.80	787	4.41	3.53	0.80	812	4.27	3.42	0.80	853
32	26	4.83	3.28	0.68	787	4.69	3.19	0.68	828	4.62	3.14	0.68	853	4.48	3.05	0.68	877

NOTE Q : Total capacity (kW) SHF : Sensible heat factor DB : Dry-bulb temperature
 SHC : Sensible heat capacity (kW) INPUT : Total power input (W) WB : Wet-bulb temperature

PERFORMANCE DATA COOL operation at Rated frequency

MUZ-LN35VG2

CAPACITY: 3.5 kW

SHF: 0.90

INPUT: 820 W

INDOOR DB (°C)	INDOOR WB (°C)	OUTDOOR DB (°C)											
		35				40				46			
		Q	SHC	SHF	INPUT	Q	SHC	SHF	INPUT	Q	SHC	SHF	INPUT
21	18	3.43	2.47	0.72	804	3.15	2.27	0.72	853	2.91	2.09	0.72	886
21	20	3.61	2.16	0.60	836	3.36	2.02	0.60	877	3.12	1.87	0.60	927
22	18	3.43	2.61	0.76	804	3.15	2.39	0.76	853	2.91	2.21	0.76	886
22	20	3.61	2.31	0.64	836	3.36	2.15	0.64	877	3.12	1.99	0.64	927
22	22	3.82	1.98	0.52	869	3.57	1.86	0.52	918	3.33	1.73	0.52	951
23	18	3.43	2.74	0.80	804	3.15	2.52	0.80	853	2.91	2.32	0.80	886
23	20	3.61	2.45	0.68	836	3.36	2.28	0.68	877	3.12	2.12	0.68	927
23	22	3.82	2.14	0.56	869	3.57	2.00	0.56	918	3.33	1.86	0.56	951
24	18	3.43	2.88	0.84	804	3.15	2.65	0.84	853	2.91	2.44	0.84	886
24	20	3.61	2.60	0.72	836	3.36	2.42	0.72	877	3.12	2.24	0.72	927
24	22	3.82	2.29	0.60	869	3.57	2.14	0.60	918	3.33	2.00	0.60	951
24	24	4.03	1.93	0.48	902	3.78	1.81	0.48	943	3.57	1.71	0.48	984
25	18	3.43	3.02	0.88	804	3.15	2.77	0.88	853	2.91	2.56	0.88	886
25	20	3.61	2.74	0.76	836	3.36	2.55	0.76	877	3.12	2.37	0.76	927
25	22	3.82	2.44	0.64	869	3.57	2.28	0.64	918	3.33	2.13	0.64	951
25	24	4.03	2.09	0.52	902	3.78	1.97	0.52	943	3.57	1.86	0.52	984
26	18	3.43	3.16	0.92	804	3.15	2.90	0.92	853	2.91	2.67	0.92	886
26	20	3.61	2.88	0.80	836	3.36	2.69	0.80	877	3.12	2.49	0.80	927
26	22	3.82	2.59	0.68	869	3.57	2.43	0.68	918	3.33	2.26	0.68	951
26	24	4.03	2.25	0.56	902	3.78	2.12	0.56	943	3.57	2.00	0.56	984
26	26	4.24	1.86	0.44	935	3.99	1.76	0.44	976	3.75	1.65	0.44	1017
27	18	3.43	3.29	0.96	804	3.15	3.02	0.96	853	2.91	2.79	0.96	886
27	20	3.61	3.03	0.84	836	3.36	2.82	0.84	877	3.12	2.62	0.84	927
27	22	3.82	2.75	0.72	869	3.57	2.57	0.72	918	3.33	2.39	0.72	951
27	24	4.03	2.42	0.60	902	3.78	2.27	0.60	943	3.57	2.14	0.60	984
27	26	4.24	2.03	0.48	935	3.99	1.92	0.48	976	3.75	1.80	0.48	1017
28	18	3.43	3.43	1.00	804	3.15	3.15	1.00	853	2.91	2.91	1.00	886
28	20	3.61	3.17	0.88	836	3.36	2.96	0.88	877	3.12	2.74	0.88	927
28	22	3.82	2.90	0.76	869	3.57	2.71	0.76	918	3.33	2.53	0.76	951
28	24	4.03	2.58	0.64	902	3.78	2.42	0.64	943	3.57	2.28	0.64	984
28	26	4.24	2.20	0.52	935	3.99	2.07	0.52	976	3.75	1.95	0.52	1017
29	18	3.43	3.43	1.00	804	3.15	3.15	1.00	853	2.91	2.91	1.00	886
29	20	3.61	3.32	0.92	836	3.36	3.09	0.92	877	3.12	2.87	0.92	927
29	22	3.82	3.05	0.80	869	3.57	2.86	0.80	918	3.33	2.66	0.80	951
29	24	4.03	2.74	0.68	902	3.78	2.57	0.68	943	3.57	2.43	0.68	984
29	26	4.24	2.37	0.56	935	3.99	2.23	0.56	976	3.75	2.10	0.56	1017
30	18	3.43	3.43	1.00	804	3.15	3.15	1.00	853	2.91	2.91	1.00	886
30	20	3.61	3.46	0.96	836	3.36	3.23	0.96	877	3.12	2.99	0.96	927
30	22	3.82	3.20	0.84	869	3.57	3.00	0.84	918	3.33	2.79	0.84	951
30	24	4.03	2.90	0.72	902	3.78	2.72	0.72	943	3.57	2.57	0.72	984
30	26	4.24	2.54	0.60	935	3.99	2.39	0.60	976	3.75	2.25	0.60	1017
31	18	3.43	3.43	1.00	804	3.15	3.15	1.00	853	2.91	2.91	1.00	886
31	20	3.61	3.61	1.00	836	3.36	3.36	1.00	877	3.12	3.12	1.00	927
31	22	3.82	3.36	0.88	869	3.57	3.14	0.88	918	3.33	2.93	0.88	951
31	24	4.03	3.06	0.76	902	3.78	2.87	0.76	943	3.57	2.71	0.76	984
31	26	4.24	2.71	0.64	935	3.99	2.55	0.64	976	3.75	2.40	0.64	1017
32	18	3.43	3.43	1.00	804	3.15	3.15	1.00	853	2.91	2.91	1.00	886
32	20	3.61	3.61	1.00	836	3.36	3.36	1.00	877	3.12	3.12	1.00	927
32	22	3.82	3.51	0.92	869	3.57	3.28	0.92	918	3.33	3.06	0.92	951
32	24	4.03	3.22	0.80	902	3.78	3.02	0.80	943	3.57	2.86	0.80	984
32	26	4.24	2.88	0.68	935	3.99	2.71	0.68	976	3.75	2.55	0.68	1017

NOTE Q : Total capacity (kW) SHF : Sensible heat factor DB : Dry-bulb temperature
 SHC : Sensible heat capacity (kW) INPUT : Total power input (W) WB : Wet-bulb temperature

PERFORMANCE DATA COOL operation at Rated frequency

MUZ-LN50VG MUZ-LN50VG2

CAPACITY: 5.0 kW SHF: 0.77 INPUT: 1380 W

INDOOR DB (°C)	INDOOR WB (°C)	OUTDOOR DB (°C)															
		21				25				27				30			
		Q	SHC	SHF	INPUT	Q	SHC	SHF	INPUT	Q	SHC	SHF	INPUT	Q	SHC	SHF	INPUT
21	18	5.88	3.47	0.59	1104	5.63	3.32	0.59	1159	5.40	3.19	0.59	1214	5.20	3.07	0.59	1270
21	20	6.13	2.88	0.47	1159	5.88	2.76	0.47	1228	5.70	2.68	0.47	1256	5.50	2.59	0.47	1311
22	18	5.88	3.70	0.63	1104	5.63	3.54	0.63	1159	5.40	3.40	0.63	1214	5.20	3.28	0.63	1270
22	20	6.13	3.12	0.51	1159	5.88	3.00	0.51	1228	5.70	2.91	0.51	1256	5.50	2.81	0.51	1311
22	22	6.38	2.49	0.39	1201	6.15	2.40	0.39	1277	6.00	2.34	0.39	1311	5.75	2.24	0.39	1366
23	18	5.88	3.94	0.67	1104	5.63	3.77	0.67	1159	5.40	3.62	0.67	1214	5.20	3.48	0.67	1270
23	20	6.13	3.37	0.55	1159	5.88	3.23	0.55	1228	5.70	3.14	0.55	1256	5.50	3.03	0.55	1311
23	22	6.38	2.74	0.43	1201	6.15	2.64	0.43	1277	6.00	2.58	0.43	1311	5.75	2.47	0.43	1366
24	18	5.88	4.17	0.71	1104	5.63	3.99	0.71	1159	5.40	3.83	0.71	1214	5.20	3.69	0.71	1270
24	20	6.13	3.61	0.59	1159	5.88	3.47	0.59	1228	5.70	3.36	0.59	1256	5.50	3.25	0.59	1311
24	22	6.38	3.00	0.47	1201	6.15	2.89	0.47	1277	6.00	2.82	0.47	1311	5.75	2.70	0.47	1366
24	24	6.70	2.35	0.35	1256	6.45	2.26	0.35	1325	6.30	2.21	0.35	1366	6.10	2.14	0.35	1435
25	18	5.88	4.41	0.75	1104	5.63	4.22	0.75	1159	5.40	4.05	0.75	1214	5.20	3.90	0.75	1270
25	20	6.13	3.86	0.63	1159	5.88	3.70	0.63	1228	5.70	3.59	0.63	1256	5.50	3.47	0.63	1311
25	22	6.38	3.25	0.51	1201	6.15	3.14	0.51	1277	6.00	3.06	0.51	1311	5.75	2.93	0.51	1366
25	24	6.70	2.61	0.39	1256	6.45	2.52	0.39	1325	6.30	2.46	0.39	1366	6.10	2.38	0.39	1435
26	18	5.88	4.64	0.79	1104	5.63	4.44	0.79	1159	5.40	4.27	0.79	1214	5.20	4.11	0.79	1270
26	20	6.13	4.10	0.67	1159	5.88	3.94	0.67	1228	5.70	3.82	0.67	1256	5.50	3.69	0.67	1311
26	22	6.38	3.51	0.55	1201	6.15	3.38	0.55	1277	6.00	3.30	0.55	1311	5.75	3.16	0.55	1366
26	24	6.70	2.88	0.43	1256	6.45	2.77	0.43	1325	6.30	2.71	0.43	1366	6.10	2.62	0.43	1435
26	26	6.90	2.14	0.31	1325	6.70	2.08	0.31	1394	6.60	2.05	0.31	1435	6.40	1.98	0.31	1477
27	18	5.88	4.88	0.83	1104	5.63	4.67	0.83	1159	5.40	4.48	0.83	1214	5.20	4.32	0.83	1270
27	20	6.13	4.35	0.71	1159	5.88	4.17	0.71	1228	5.70	4.05	0.71	1256	5.50	3.91	0.71	1311
27	22	6.38	3.76	0.59	1201	6.15	3.63	0.59	1277	6.00	3.54	0.59	1311	5.75	3.39	0.59	1366
27	24	6.70	3.15	0.47	1256	6.45	3.03	0.47	1325	6.30	2.96	0.47	1366	6.10	2.87	0.47	1435
27	26	6.90	2.42	0.35	1325	6.70	2.35	0.35	1394	6.60	2.31	0.35	1435	6.40	2.24	0.35	1477
28	18	5.88	5.11	0.87	1104	5.63	4.89	0.87	1159	5.40	4.70	0.87	1214	5.20	4.52	0.87	1270
28	20	6.13	4.59	0.75	1159	5.88	4.41	0.75	1228	5.70	4.28	0.75	1256	5.50	4.13	0.75	1311
28	22	6.38	4.02	0.63	1201	6.15	3.87	0.63	1277	6.00	3.78	0.63	1311	5.75	3.62	0.63	1366
28	24	6.70	3.42	0.51	1256	6.45	3.29	0.51	1325	6.30	3.21	0.51	1366	6.10	3.11	0.51	1435
28	26	6.90	2.69	0.39	1325	6.70	2.61	0.39	1394	6.60	2.57	0.39	1435	6.40	2.50	0.39	1477
29	18	5.88	5.35	0.91	1104	5.63	5.12	0.91	1159	5.40	4.91	0.91	1214	5.20	4.73	0.91	1270
29	20	6.13	4.84	0.79	1159	5.88	4.64	0.79	1228	5.70	4.50	0.79	1256	5.50	4.35	0.79	1311
29	22	6.38	4.27	0.67	1201	6.15	4.12	0.67	1277	6.00	4.02	0.67	1311	5.75	3.85	0.67	1366
29	24	6.70	3.69	0.55	1256	6.45	3.55	0.55	1325	6.30	3.47	0.55	1366	6.10	3.36	0.55	1435
29	26	6.90	2.97	0.43	1325	6.70	2.88	0.43	1394	6.60	2.84	0.43	1435	6.40	2.75	0.43	1477
30	18	5.88	5.58	0.95	1104	5.63	5.34	0.95	1159	5.40	5.13	0.95	1214	5.20	4.94	0.95	1270
30	20	6.13	5.08	0.83	1159	5.88	4.88	0.83	1228	5.70	4.73	0.83	1256	5.50	4.57	0.83	1311
30	22	6.38	4.53	0.71	1201	6.15	4.37	0.71	1277	6.00	4.26	0.71	1311	5.75	4.08	0.71	1366
30	24	6.70	3.95	0.59	1256	6.45	3.81	0.59	1325	6.30	3.72	0.59	1366	6.10	3.60	0.59	1435
30	26	6.90	3.24	0.47	1325	6.70	3.15	0.47	1394	6.60	3.10	0.47	1435	6.40	3.01	0.47	1477
31	18	5.88	5.82	0.99	1104	5.63	5.57	0.99	1159	5.40	5.35	0.99	1214	5.20	5.15	0.99	1270
31	20	6.13	5.33	0.87	1159	5.88	5.11	0.87	1228	5.70	4.96	0.87	1256	5.50	4.79	0.87	1311
31	22	6.38	4.78	0.75	1201	6.15	4.61	0.75	1277	6.00	4.50	0.75	1311	5.75	4.31	0.75	1366
31	24	6.70	4.22	0.63	1256	6.45	4.06	0.63	1325	6.30	3.97	0.63	1366	6.10	3.84	0.63	1435
31	26	6.90	3.52	0.51	1325	6.70	3.42	0.51	1394	6.60	3.37	0.51	1435	6.40	3.26	0.51	1477
32	18	5.88	5.88	1.00	1104	5.63	5.63	1.00	1159	5.40	5.40	1.00	1214	5.20	5.20	1.00	1270
32	20	6.13	5.57	0.91	1159	5.88	5.35	0.91	1228	5.70	5.19	0.91	1256	5.50	5.01	0.91	1311
32	22	6.38	5.04	0.79	1201	6.15	4.86	0.79	1277	6.00	4.74	0.79	1311	5.75	4.54	0.79	1366
32	24	6.70	4.49	0.67	1256	6.45	4.32	0.67	1325	6.30	4.22	0.67	1366	6.10	4.09	0.67	1435
32	26	6.90	3.80	0.55	1325	6.70	3.69	0.55	1394	6.60	3.63	0.55	1435	6.40	3.52	0.55	1477

NOTE Q : Total capacity (kW) SHF : Sensible heat factor DB : Dry-bulb temperature
 SHC : Sensible heat capacity (kW) INPUT : Total power input (W) WB : Wet-bulb temperature

PERFORMANCE DATA COOL operation at Rated frequency

MUZ-LN50VG MUZ-LN50VG2

CAPACITY: 5.0 kW

SHF: 0.77

INPUT: 1380 W

INDOOR DB (°C)	INDOOR WB (°C)	OUTDOOR DB (°C)											
		35				40				46			
		Q	SHC	SHF	INPUT	Q	SHC	SHF	INPUT	Q	SHC	SHF	INPUT
21	18	4.90	2.89	0.59	1352	4.50	2.66	0.59	1435	4.15	2.45	0.59	1490
21	20	5.15	2.42	0.47	1408	4.80	2.26	0.47	1477	4.45	2.09	0.47	1559
22	18	4.90	3.09	0.63	1352	4.50	2.84	0.63	1435	4.15	2.61	0.63	1490
22	20	5.15	2.63	0.51	1408	4.80	2.45	0.51	1477	4.45	2.27	0.51	1559
22	22	5.45	2.13	0.39	1463	5.10	1.99	0.39	1546	4.75	1.85	0.39	1601
23	18	4.90	3.28	0.67	1352	4.50	3.02	0.67	1435	4.15	2.78	0.67	1490
23	20	5.15	2.83	0.55	1408	4.80	2.64	0.55	1477	4.45	2.45	0.55	1559
23	22	5.45	2.34	0.43	1463	5.10	2.19	0.43	1546	4.75	2.04	0.43	1601
24	18	4.90	3.48	0.71	1352	4.50	3.20	0.71	1435	4.15	2.95	0.71	1490
24	20	5.15	3.04	0.59	1408	4.80	2.83	0.59	1477	4.45	2.63	0.59	1559
24	22	5.45	2.56	0.47	1463	5.10	2.40	0.47	1546	4.75	2.23	0.47	1601
24	24	5.75	2.01	0.35	1518	5.40	1.89	0.35	1587	5.10	1.79	0.35	1656
25	18	4.90	3.68	0.75	1352	4.50	3.38	0.75	1435	4.15	3.11	0.75	1490
25	20	5.15	3.24	0.63	1408	4.80	3.02	0.63	1477	4.45	2.80	0.63	1559
25	22	5.45	2.78	0.51	1463	5.10	2.60	0.51	1546	4.75	2.42	0.51	1601
25	24	5.75	2.24	0.39	1518	5.40	2.11	0.39	1587	5.10	1.99	0.39	1656
26	18	4.90	3.87	0.79	1352	4.50	3.56	0.79	1435	4.15	3.28	0.79	1490
26	20	5.15	3.45	0.67	1408	4.80	3.22	0.67	1477	4.45	2.98	0.67	1559
26	22	5.45	3.00	0.55	1463	5.10	2.81	0.55	1546	4.75	2.61	0.55	1601
26	24	5.75	2.47	0.43	1518	5.40	2.32	0.43	1587	5.10	2.19	0.43	1656
26	26	6.05	1.88	0.31	1573	5.70	1.77	0.31	1642	5.35	1.66	0.31	1711
27	18	4.90	4.07	0.83	1352	4.50	3.74	0.83	1435	4.15	3.44	0.83	1490
27	20	5.15	3.66	0.71	1408	4.80	3.41	0.71	1477	4.45	3.16	0.71	1559
27	22	5.45	3.22	0.59	1463	5.10	3.01	0.59	1546	4.75	2.80	0.59	1601
27	24	5.75	2.70	0.47	1518	5.40	2.54	0.47	1587	5.10	2.40	0.47	1656
27	26	6.05	2.12	0.35	1573	5.70	2.00	0.35	1642	5.35	1.87	0.35	1711
28	18	4.90	4.26	0.87	1352	4.50	3.92	0.87	1435	4.15	3.61	0.87	1490
28	20	5.15	3.86	0.75	1408	4.80	3.60	0.75	1477	4.45	3.34	0.75	1559
28	22	5.45	3.43	0.63	1463	5.10	3.21	0.63	1546	4.75	2.99	0.63	1601
28	24	5.75	2.93	0.51	1518	5.40	2.75	0.51	1587	5.10	2.60	0.51	1656
28	26	6.05	2.36	0.39	1573	5.70	2.22	0.39	1642	5.35	2.09	0.39	1711
29	18	4.90	4.46	0.91	1352	4.50	4.10	0.91	1435	4.15	3.78	0.91	1490
29	20	5.15	4.07	0.79	1408	4.80	3.79	0.79	1477	4.45	3.52	0.79	1559
29	22	5.45	3.65	0.67	1463	5.10	3.42	0.67	1546	4.75	3.18	0.67	1601
29	24	5.75	3.16	0.55	1518	5.40	2.97	0.55	1587	5.10	2.81	0.55	1656
29	26	6.05	2.60	0.43	1573	5.70	2.45	0.43	1642	5.35	2.30	0.43	1711
30	18	4.90	4.66	0.95	1352	4.50	4.28	0.95	1435	4.15	3.94	0.95	1490
30	20	5.15	4.27	0.83	1408	4.80	3.98	0.83	1477	4.45	3.69	0.83	1559
30	22	5.45	3.87	0.71	1463	5.10	3.62	0.71	1546	4.75	3.37	0.71	1601
30	24	5.75	3.39	0.59	1518	5.40	3.19	0.59	1587	5.10	3.01	0.59	1656
30	26	6.05	2.84	0.47	1573	5.70	2.68	0.47	1642	5.35	2.51	0.47	1711
31	18	4.90	4.85	0.99	1352	4.50	4.46	0.99	1435	4.15	4.11	0.99	1490
31	20	5.15	4.48	0.87	1408	4.80	4.18	0.87	1477	4.45	3.87	0.87	1559
31	22	5.45	4.09	0.75	1463	5.10	3.83	0.75	1546	4.75	3.56	0.75	1601
31	24	5.75	3.62	0.63	1518	5.40	3.40	0.63	1587	5.10	3.21	0.63	1656
31	26	6.05	3.09	0.51	1573	5.70	2.91	0.51	1642	5.35	2.73	0.51	1711
32	18	4.90	4.90	1.00	1352	4.50	4.50	1.00	1435	4.15	4.15	1.00	1490
32	20	5.15	4.69	0.91	1408	4.80	4.37	0.91	1477	4.45	4.05	0.91	1559
32	22	5.45	4.31	0.79	1463	5.10	4.03	0.79	1546	4.75	3.75	0.79	1601
32	24	5.75	3.85	0.67	1518	5.40	3.62	0.67	1587	5.10	3.42	0.67	1656
32	26	6.05	3.33	0.55	1573	5.70	3.14	0.55	1642	5.35	2.94	0.55	1711

NOTE Q : Total capacity (kW) SHF : Sensible heat factor DB : Dry-bulb temperature
 SHC : Sensible heat capacity (kW) INPUT : Total power input (W) WB : Wet-bulb temperature

PERFORMANCE DATA COOL operation at Rated frequency

MUZ-LN60VG

CAPACITY: 6.1 kW

SHF: 0.75

INPUT: 1790 W

INDOOR DB (°C)	INDOOR WB (°C)	OUTDOOR DB (°C)															
		21				25				27				30			
		Q	SHC	SHF	INPUT	Q	SHC	SHF	INPUT	Q	SHC	SHF	INPUT	Q	SHC	SHF	INPUT
21	18	7.17	4.09	0.57	1432	6.86	3.91	0.57	1504	6.59	3.76	0.57	1575	6.34	3.62	0.57	1647
21	20	7.47	3.36	0.45	1504	7.17	3.23	0.45	1593	6.95	3.13	0.45	1629	6.71	3.02	0.45	1701
22	18	7.17	4.37	0.61	1432	6.86	4.19	0.61	1504	6.59	4.02	0.61	1575	6.34	3.87	0.61	1647
22	20	7.47	3.66	0.49	1504	7.17	3.51	0.49	1593	6.95	3.41	0.49	1629	6.71	3.29	0.49	1701
22	22	7.78	2.88	0.37	1557	7.50	2.78	0.37	1656	7.32	2.71	0.37	1701	7.01	2.60	0.37	1772
23	18	7.17	4.66	0.65	1432	6.86	4.46	0.65	1504	6.59	4.28	0.65	1575	6.34	4.12	0.65	1647
23	20	7.47	3.96	0.53	1504	7.17	3.80	0.53	1593	6.95	3.69	0.53	1629	6.71	3.56	0.53	1701
23	22	7.78	3.19	0.41	1557	7.50	3.08	0.41	1656	7.32	3.00	0.41	1701	7.01	2.88	0.41	1772
24	18	7.17	4.95	0.69	1432	6.86	4.74	0.69	1504	6.59	4.55	0.69	1575	6.34	4.38	0.69	1647
24	20	7.47	4.26	0.57	1504	7.17	4.09	0.57	1593	6.95	3.96	0.57	1629	6.71	3.82	0.57	1701
24	22	7.78	3.50	0.45	1557	7.50	3.38	0.45	1656	7.32	3.29	0.45	1701	7.01	3.16	0.45	1772
24	24	8.17	2.70	0.33	1629	7.87	2.60	0.33	1718	7.69	2.54	0.33	1772	7.44	2.46	0.33	1862
25	18	7.17	5.23	0.73	1432	6.86	5.01	0.73	1504	6.59	4.81	0.73	1575	6.34	4.63	0.73	1647
25	20	7.47	4.56	0.61	1504	7.17	4.37	0.61	1593	6.95	4.24	0.61	1629	6.71	4.09	0.61	1701
25	22	7.78	3.81	0.49	1557	7.50	3.68	0.49	1656	7.32	3.59	0.49	1701	7.01	3.44	0.49	1772
25	24	8.17	3.02	0.37	1629	7.87	2.91	0.37	1718	7.69	2.84	0.37	1772	7.44	2.75	0.37	1862
26	18	7.17	5.52	0.77	1432	6.86	5.28	0.77	1504	6.59	5.07	0.77	1575	6.34	4.88	0.77	1647
26	20	7.47	4.86	0.65	1504	7.17	4.66	0.65	1593	6.95	4.52	0.65	1629	6.71	4.36	0.65	1701
26	22	7.78	4.12	0.53	1557	7.50	3.98	0.53	1656	7.32	3.88	0.53	1701	7.01	3.72	0.53	1772
26	24	8.17	3.35	0.41	1629	7.87	3.23	0.41	1718	7.69	3.15	0.41	1772	7.44	3.05	0.41	1862
26	26	8.42	2.44	0.29	1718	8.17	2.37	0.29	1808	8.05	2.34	0.29	1862	7.81	2.26	0.29	1915
27	18	7.17	5.81	0.81	1432	6.86	5.56	0.81	1504	6.59	5.34	0.81	1575	6.34	5.14	0.81	1647
27	20	7.47	5.16	0.69	1504	7.17	4.95	0.69	1593	6.95	4.80	0.69	1629	6.71	4.63	0.69	1701
27	22	7.78	4.43	0.57	1557	7.50	4.28	0.57	1656	7.32	4.17	0.57	1701	7.01	4.00	0.57	1772
27	24	8.17	3.68	0.45	1629	7.87	3.54	0.45	1718	7.69	3.46	0.45	1772	7.44	3.35	0.45	1862
27	26	8.42	2.78	0.33	1718	8.17	2.70	0.33	1808	8.05	2.66	0.33	1862	7.81	2.58	0.33	1915
28	18	7.17	6.09	0.85	1432	6.86	5.83	0.85	1504	6.59	5.60	0.85	1575	6.34	5.39	0.85	1647
28	20	7.47	5.45	0.73	1504	7.17	5.23	0.73	1593	6.95	5.08	0.73	1629	6.71	4.90	0.73	1701
28	22	7.78	4.74	0.61	1557	7.50	4.58	0.61	1656	7.32	4.47	0.61	1701	7.01	4.28	0.61	1772
28	24	8.17	4.01	0.49	1629	7.87	3.86	0.49	1718	7.69	3.77	0.49	1772	7.44	3.65	0.49	1862
28	26	8.42	3.11	0.37	1718	8.17	3.02	0.37	1808	8.05	2.98	0.37	1862	7.81	2.89	0.37	1915
29	18	7.17	6.38	0.89	1432	6.86	6.11	0.89	1504	6.59	5.86	0.89	1575	6.34	5.65	0.89	1647
29	20	7.47	5.75	0.77	1504	7.17	5.52	0.77	1593	6.95	5.35	0.77	1629	6.71	5.17	0.77	1701
29	22	7.78	5.06	0.65	1557	7.50	4.88	0.65	1656	7.32	4.76	0.65	1701	7.01	4.56	0.65	1772
29	24	8.17	4.33	0.53	1629	7.87	4.17	0.53	1718	7.69	4.07	0.53	1772	7.44	3.94	0.53	1862
29	26	8.42	3.45	0.41	1718	8.17	3.35	0.41	1808	8.05	3.30	0.41	1862	7.81	3.20	0.41	1915
30	18	7.17	6.67	0.93	1432	6.86	6.38	0.93	1504	6.59	6.13	0.93	1575	6.34	5.90	0.93	1647
30	20	7.47	6.05	0.81	1504	7.17	5.81	0.81	1593	6.95	5.63	0.81	1629	6.71	5.44	0.81	1701
30	22	7.78	5.37	0.69	1557	7.50	5.18	0.69	1656	7.32	5.05	0.69	1701	7.01	4.84	0.69	1772
30	24	8.17	4.66	0.57	1629	7.87	4.49	0.57	1718	7.69	4.38	0.57	1772	7.44	4.24	0.57	1862
30	26	8.42	3.79	0.45	1718	8.17	3.68	0.45	1808	8.05	3.62	0.45	1862	7.81	3.51	0.45	1915
31	18	7.17	6.95	0.97	1432	6.86	6.66	0.97	1504	6.59	6.39	0.97	1575	6.34	6.15	0.97	1647
31	20	7.47	6.35	0.85	1504	7.17	6.09	0.85	1593	6.95	5.91	0.85	1629	6.71	5.70	0.85	1701
31	22	7.78	5.68	0.73	1557	7.50	5.48	0.73	1656	7.32	5.34	0.73	1701	7.01	5.12	0.73	1772
31	24	8.17	4.99	0.61	1629	7.87	4.80	0.61	1718	7.69	4.69	0.61	1772	7.44	4.54	0.61	1862
31	26	8.42	4.12	0.49	1718	8.17	4.01	0.49	1808	8.05	3.95	0.49	1862	7.81	3.83	0.49	1915
32	18	7.17	7.17	1.00	1432	6.86	6.86	1.00	1504	6.59	6.59	1.00	1575	6.34	6.34	1.00	1647
32	20	7.47	6.65	0.89	1504	7.17	6.38	0.89	1593	6.95	6.19	0.89	1629	6.71	5.97	0.89	1701
32	22	7.78	5.99	0.77	1557	7.50	5.78	0.77	1656	7.32	5.64	0.77	1701	7.01	5.40	0.77	1772
32	24	8.17	5.31	0.65	1629	7.87	5.11	0.65	1718	7.69	5.00	0.65	1772	7.44	4.84	0.65	1862
32	26	8.42	4.46	0.53	1718	8.17	4.33	0.53	1808	8.05	4.27	0.53	1862	7.81	4.14	0.53	1915

NOTE Q : Total capacity (kW) SHF : Sensible heat factor DB : Dry-bulb temperature
 SHC : Sensible heat capacity (kW) INPUT : Total power input (W) WB : Wet-bulb temperature

PERFORMANCE DATA COOL operation at Rated frequency

MUZ-LN60VG

CAPACITY: 6.1 kW

SHF: 0.75

INPUT: 1790 W

INDOOR DB (°C)	INDOOR WB (°C)	OUTDOOR DB (°C)											
		35				40				46			
		Q	SHC	SHF	INPUT	Q	SHC	SHF	INPUT	Q	SHC	SHF	INPUT
21	18	5.98	3.41	0.57	1754	5.49	3.13	0.57	1862	5.06	2.89	0.57	1933
21	20	6.28	2.83	0.45	1826	5.86	2.64	0.45	1915	5.43	2.44	0.45	2023
22	18	5.98	3.65	0.61	1754	5.49	3.35	0.61	1862	5.06	3.09	0.61	1933
22	20	6.28	3.08	0.49	1826	5.86	2.87	0.49	1915	5.43	2.66	0.49	2023
22	22	6.65	2.46	0.37	1897	6.22	2.30	0.37	2005	5.79	2.14	0.37	2076
23	18	5.98	3.89	0.65	1754	5.49	3.57	0.65	1862	5.06	3.29	0.65	1933
23	20	6.28	3.33	0.53	1826	5.86	3.10	0.53	1915	5.43	2.88	0.53	2023
23	22	6.65	2.73	0.41	1897	6.22	2.55	0.41	2005	5.79	2.38	0.41	2076
24	18	5.98	4.12	0.69	1754	5.49	3.79	0.69	1862	5.06	3.49	0.69	1933
24	20	6.28	3.58	0.57	1826	5.86	3.34	0.57	1915	5.43	3.09	0.57	2023
24	22	6.65	2.99	0.45	1897	6.22	2.80	0.45	2005	5.79	2.61	0.45	2076
24	24	7.01	2.31	0.33	1969	6.59	2.17	0.33	2059	6.22	2.05	0.33	2148
25	18	5.98	4.36	0.73	1754	5.49	4.01	0.73	1862	5.06	3.70	0.73	1933
25	20	6.28	3.83	0.61	1826	5.86	3.57	0.61	1915	5.43	3.31	0.61	2023
25	22	6.65	3.26	0.49	1897	6.22	3.05	0.49	2005	5.79	2.84	0.49	2076
25	24	7.01	2.60	0.37	1969	6.59	2.44	0.37	2059	6.22	2.30	0.37	2148
26	18	5.98	4.60	0.77	1754	5.49	4.23	0.77	1862	5.06	3.90	0.77	1933
26	20	6.28	4.08	0.65	1826	5.86	3.81	0.65	1915	5.43	3.53	0.65	2023
26	22	6.65	3.52	0.53	1897	6.22	3.30	0.53	2005	5.79	3.07	0.53	2076
26	24	7.01	2.88	0.41	1969	6.59	2.70	0.41	2059	6.22	2.55	0.41	2148
26	26	7.38	2.14	0.29	2041	6.95	2.02	0.29	2130	6.53	1.89	0.29	2220
27	18	5.98	4.84	0.81	1754	5.49	4.45	0.81	1862	5.06	4.10	0.81	1933
27	20	6.28	4.34	0.69	1826	5.86	4.04	0.69	1915	5.43	3.75	0.69	2023
27	22	6.65	3.79	0.57	1897	6.22	3.55	0.57	2005	5.79	3.30	0.57	2076
27	24	7.01	3.16	0.45	1969	6.59	2.96	0.45	2059	6.22	2.80	0.45	2148
27	26	7.38	2.44	0.33	2041	6.95	2.29	0.33	2130	6.53	2.15	0.33	2220
28	18	5.98	5.08	0.85	1754	5.49	4.67	0.85	1862	5.06	4.30	0.85	1933
28	20	6.28	4.59	0.73	1826	5.86	4.27	0.73	1915	5.43	3.96	0.73	2023
28	22	6.65	4.06	0.61	1897	6.22	3.80	0.61	2005	5.79	3.53	0.61	2076
28	24	7.01	3.44	0.49	1969	6.59	3.23	0.49	2059	6.22	3.05	0.49	2148
28	26	7.38	2.73	0.37	2041	6.95	2.57	0.37	2130	6.53	2.41	0.37	2220
29	18	5.98	5.32	0.89	1754	5.49	4.89	0.89	1862	5.06	4.51	0.89	1933
29	20	6.28	4.84	0.77	1826	5.86	4.51	0.77	1915	5.43	4.18	0.77	2023
29	22	6.65	4.32	0.65	1897	6.22	4.04	0.65	2005	5.79	3.77	0.65	2076
29	24	7.01	3.72	0.53	1969	6.59	3.49	0.53	2059	6.22	3.30	0.53	2148
29	26	7.38	3.03	0.41	2041	6.95	2.85	0.41	2130	6.53	2.68	0.41	2220
30	18	5.98	5.56	0.93	1754	5.49	5.11	0.93	1862	5.06	4.71	0.93	1933
30	20	6.28	5.09	0.81	1826	5.86	4.74	0.81	1915	5.43	4.40	0.81	2023
30	22	6.65	4.59	0.69	1897	6.22	4.29	0.69	2005	5.79	4.00	0.69	2076
30	24	7.01	4.00	0.57	1969	6.59	3.76	0.57	2059	6.22	3.55	0.57	2148
30	26	7.38	3.32	0.45	2041	6.95	3.13	0.45	2130	6.53	2.94	0.45	2220
31	18	5.98	5.80	0.97	1754	5.49	5.33	0.97	1862	5.06	4.91	0.97	1933
31	20	6.28	5.34	0.85	1826	5.86	4.98	0.85	1915	5.43	4.61	0.85	2023
31	22	6.65	4.85	0.73	1897	6.22	4.54	0.73	2005	5.79	4.23	0.73	2076
31	24	7.01	4.28	0.61	1969	6.59	4.02	0.61	2059	6.22	3.80	0.61	2148
31	26	7.38	3.62	0.49	2041	6.95	3.41	0.49	2130	6.53	3.20	0.49	2220
32	18	5.98	5.98	1.00	1754	5.49	5.49	1.00	1862	5.06	5.06	1.00	1933
32	20	6.28	5.59	0.89	1826	5.86	5.21	0.89	1915	5.43	4.83	0.89	2023
32	22	6.65	5.12	0.77	1897	6.22	4.79	0.77	2005	5.79	4.46	0.77	2076
32	24	7.01	4.56	0.65	1969	6.59	4.28	0.65	2059	6.22	4.04	0.65	2148
32	26	7.38	3.91	0.53	2041	6.95	3.69	0.53	2130	6.53	3.46	0.53	2220

NOTE Q : Total capacity (kW) SHF : Sensible heat factor DB : Dry-bulb temperature
 SHC : Sensible heat capacity (kW) INPUT : Total power input (W) WB : Wet-bulb temperature

PERFORMANCE DATA HEAT operation at Rated frequency

MUZ-LN25VG

CAPACITY: 3.2 kW INPUT: 580 W

INDOOR DB (°C)	OUTDOOR WB (°C)													
	-10		-5		0		5		10		15		20	
	Q	INPUT	Q	INPUT	Q	INPUT	Q	INPUT	Q	INPUT	Q	INPUT	Q	INPUT
15	2.02	377	2.43	452	2.85	510	3.26	551	3.68	586	4.06	603	4.48	615
21	1.92	406	2.30	481	2.72	534	3.10	574	3.52	603	3.90	621	4.30	644
26	1.73	435	2.14	510	2.53	563	2.94	603	3.36	632	3.74	650	4.16	667

MUZ-LN25VG2

CAPACITY: 3.2 kW INPUT: 600 W

INDOOR DB (°C)	OUTDOOR WB (°C)													
	-10		-5		0		5		10		15		20	
	Q	INPUT	Q	INPUT	Q	INPUT	Q	INPUT	Q	INPUT	Q	INPUT	Q	INPUT
15	2.02	390	2.43	468	2.85	528	3.26	570	3.68	606	4.06	624	4.48	636
21	1.92	420	2.30	498	2.72	552	3.10	594	3.52	624	3.90	642	4.30	666
26	1.73	450	2.14	528	2.53	582	2.94	624	3.36	654	3.74	672	4.16	690

MUZ-LN35VG

CAPACITY: 4.0 kW INPUT: 800 W

INDOOR DB (°C)	OUTDOOR WB (°C)													
	-10		-5		0		5		10		15		20	
	Q	INPUT	Q	INPUT	Q	INPUT	Q	INPUT	Q	INPUT	Q	INPUT	Q	INPUT
15	2.52	520	3.04	624	3.56	704	4.08	760	4.60	808	5.08	832	5.60	848
21	2.40	560	2.88	664	3.40	736	3.88	792	4.40	832	4.88	856	5.38	888
26	2.16	600	2.68	704	3.16	776	3.68	832	4.20	872	4.68	896	5.20	920

MUZ-LN35VG2

CAPACITY: 4.0 kW INPUT: 820 W

INDOOR DB (°C)	OUTDOOR WB (°C)													
	-10		-5		0		5		10		15		20	
	Q	INPUT	Q	INPUT	Q	INPUT	Q	INPUT	Q	INPUT	Q	INPUT	Q	INPUT
15	2.52	533	3.04	640	3.56	722	4.08	779	4.60	828	5.08	853	5.60	869
21	2.40	574	2.88	681	3.40	754	3.88	812	4.40	853	4.88	877	5.38	910
26	2.16	615	2.68	722	3.16	795	3.68	853	4.20	894	4.68	918	5.20	943

MUZ-LN50VG MUZ-LN50VG2

CAPACITY: 6.0 kW INPUT: 1480 W

INDOOR DB (°C)	OUTDOOR WB (°C)													
	-10		-5		0		5		10		15		20	
	Q	INPUT	Q	INPUT	Q	INPUT	Q	INPUT	Q	INPUT	Q	INPUT	Q	INPUT
15	3.78	962	4.56	1154	5.34	1302	6.12	1406	6.90	1495	7.62	1539	8.40	1569
21	3.60	1036	4.32	1228	5.10	1362	5.82	1465	6.60	1539	7.32	1584	8.07	1643
26	3.24	1110	4.02	1302	4.74	1436	5.52	1539	6.30	1613	7.02	1658	7.80	1702

MUZ-LN60VG

CAPACITY: 6.8 kW INPUT: 1810 W

INDOOR DB (°C)	OUTDOOR WB (°C)													
	-10		-5		0		5		10		15		20	
	Q	INPUT	Q	INPUT	Q	INPUT	Q	INPUT	Q	INPUT	Q	INPUT	Q	INPUT
15	4.28	1177	5.17	1412	6.05	1593	6.94	1720	7.82	1828	8.64	1882	9.52	1919
21	4.08	1267	4.90	1502	5.78	1665	6.60	1792	7.48	1882	8.30	1937	9.15	2009
26	3.67	1358	4.56	1593	5.37	1756	6.26	1882	7.14	1973	7.96	2027	8.84	2082

NOTE: Q: Total capacity (kW) INPUT : Total power input (W) DB: Dry-bulb temperature WB: Wet-bulb temperature

MUZ-LN25VG MUZ-LN35VG MUZ-LN50VG MUZ-LN60VG
 MUZ-LN25VG2 MUZ-LN35VG2 MUZ-LN50VG2

10-1. OUTDOOR FAN MOTOR CONTROL

The fan motor turns ON/OFF, interlocking with the compressor.
 [ON] The fan motor turns ON 5 seconds before the compressor starts up.
 [OFF] The fan motor turns OFF 15 seconds after the compressor has stopped running.

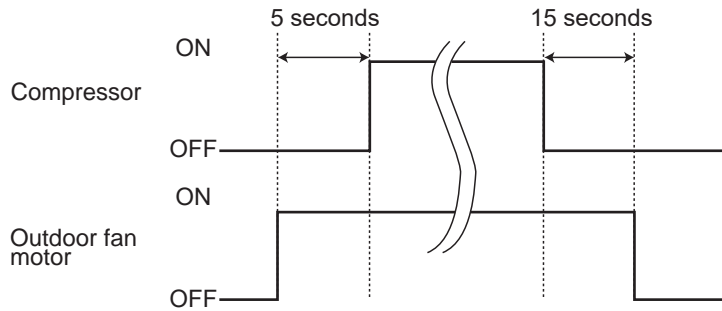

10-2. R.V. COIL CONTROL

Heating ON
 Cooling OFF
 Dry OFF

NOTE: The 4-way valve reverses for 5 seconds right before startup of the compressor.

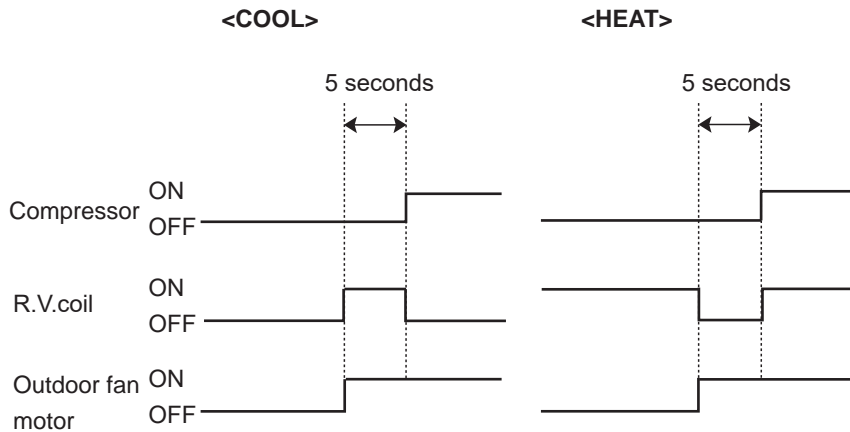

10-3. RELATION BETWEEN MAIN SENSOR AND ACTUATOR

Sensor	Purpose	Actuator				
		Compressor	LEV	Outdoor fan motor	R.V. coil	Indoor fan motor
Discharge temperature thermistor	Protection	○	○			
Indoor coil temperature thermistor	Cooling: Coil frost prevention	○				
	Heating: High pressure protection	○	○			
Defrost thermistor	Heating: Defrosting	○	○	○	○	○
Fin temperature thermistor	Protection	○		○		
Ambient temperature thermistor	Cooling: Low ambient temperature operation	○	○	○		
Outdoor heat exchanger temperature thermistor	Cooling: Low ambient temperature operation	○	○	○		
	Cooling: High pressure protection	○	○	○		

MUZ-LN25VG MUZ-LN35VG MUZ-LN50VG MUZ-LN60VG
MUZ-LN25VG2 MUZ-LN35VG2 MUZ-LN50VG2

11-1. CHANGE IN DEFROST SETTING

Changing defrost finish temperature

<JS> To change the defrost finish temperature, cut/solder the JS wire of the outdoor inverter P.C. board.
 (Refer to 12-6.1)

Jumper wire		Defrost finish temperature (°C)	
		MUZ-LN25/35/50VG MUZ-LN25/35/50VG2	MUZ-LN60VG
JS	Soldered (Initial setting)	5	10
	None (Cut)	10	18

11-2. PRE-HEAT CONTROL SETTING

PRE-HEAT CONTROL

MUZ-LN25/35/50

When moisture gets into the refrigerant cycle, it may interfere the startup of the compressor at low outside temperature. The pre-heat control prevents this interference. The pre-heat control turns ON when the discharge temperature thermostat is 20°C or below. When the pre-heat control turns ON, the compressor is energized. (About 50 W)

MUZ-LN60

Prolonged low load operation, in which the thermostat is OFF for a long time, at low outside temperature (0°C or less) may cause the following troubles. To prevent those troubles, activate the pre-heat control.

- 1) If moisture gets into the refrigerant cycle and freezes, it may interfere the startup of the compressor.
- 2) If liquid refrigerant collects in the compressor, a failure in the compressor may occur.

The pre-heat control turns ON when the compressor temperature is 20°C or below. When the pre-heat control turns ON, the compressor is energized. (About 70 W)

Pre-heat control setting

<JK>

ON: To activate the pre-heat control, cut the JK wire of the inverter P.C. board.

OFF: To deactivate the pre-heat control, solder the JK wire of the inverter P.C. board.

(Refer to 12-6.1)

NOTE: When the inverter P.C. board is replaced, check the jumper wires, and cut/solder them if necessary.

MUZ-LN25VG MUZ-LN35VG MUZ-LN50VG MUZ-LN60VG
 MUZ-LN25VG2 MUZ-LN35VG2 MUZ-LN50VG2

12-1. CAUTIONS ON TROUBLESHOOTING

1. Before troubleshooting, check the following

- 1) Check the power supply voltage.
- 2) Check the indoor/outdoor connecting wire for miswiring.

2. Take care of the following during servicing

- 1) Before servicing the air conditioner, be sure to turn OFF the main unit first with the remote controller, and then after confirming the horizontal vane is closed, turn OFF the breaker and/or disconnect the power plug.
- 2) Be sure to turn OFF the power supply before removing the front panel, the cabinet, the top panel, and the electronic control P.C. board.
- 3) When removing the electrical parts, be careful of the residual voltage of smoothing capacitor.
- 4) When removing the electronic control P.C. board, hold the edge of the board with care NOT to apply stress on the components.
- 5) When connecting or disconnecting the connectors, hold the connector housing. DO NOT pull the lead wires.

<Incorrect>



Lead wiring

<Correct>



Connector housing

3. Troubleshooting procedure

- 1) Check if the OPERATION INDICATOR lamp on the indoor unit is blinking on and off to indicate an abnormality.
To make sure, check how many times the OPERATION INDICATOR lamp is blinking on and off before starting service work.
- 2) Before servicing, check that the connector and terminal are connected properly.
- 3) When the electronic control P.C. board seems to be defective, check the copper foil pattern for disconnection and the components for bursting and discoloration.
- 4) Refer to 12-2 and 12-3.

12-2. FAILURE MODE RECALL FUNCTION

Outline of the function

This air conditioner can memorize the abnormal condition which has occurred once.

Even though LED indication listed on the troubleshooting check table (12-3.) disappears, the memorized failure details can be recalled.

1. Flow chart of failure mode recall function for the indoor/outdoor unit

MSZ-LN25/35VG
MSZ-LN50/60VG

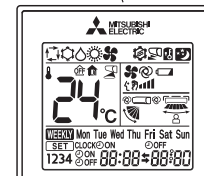
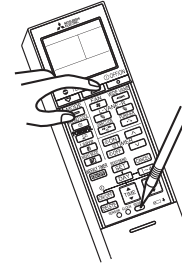

Operational procedure

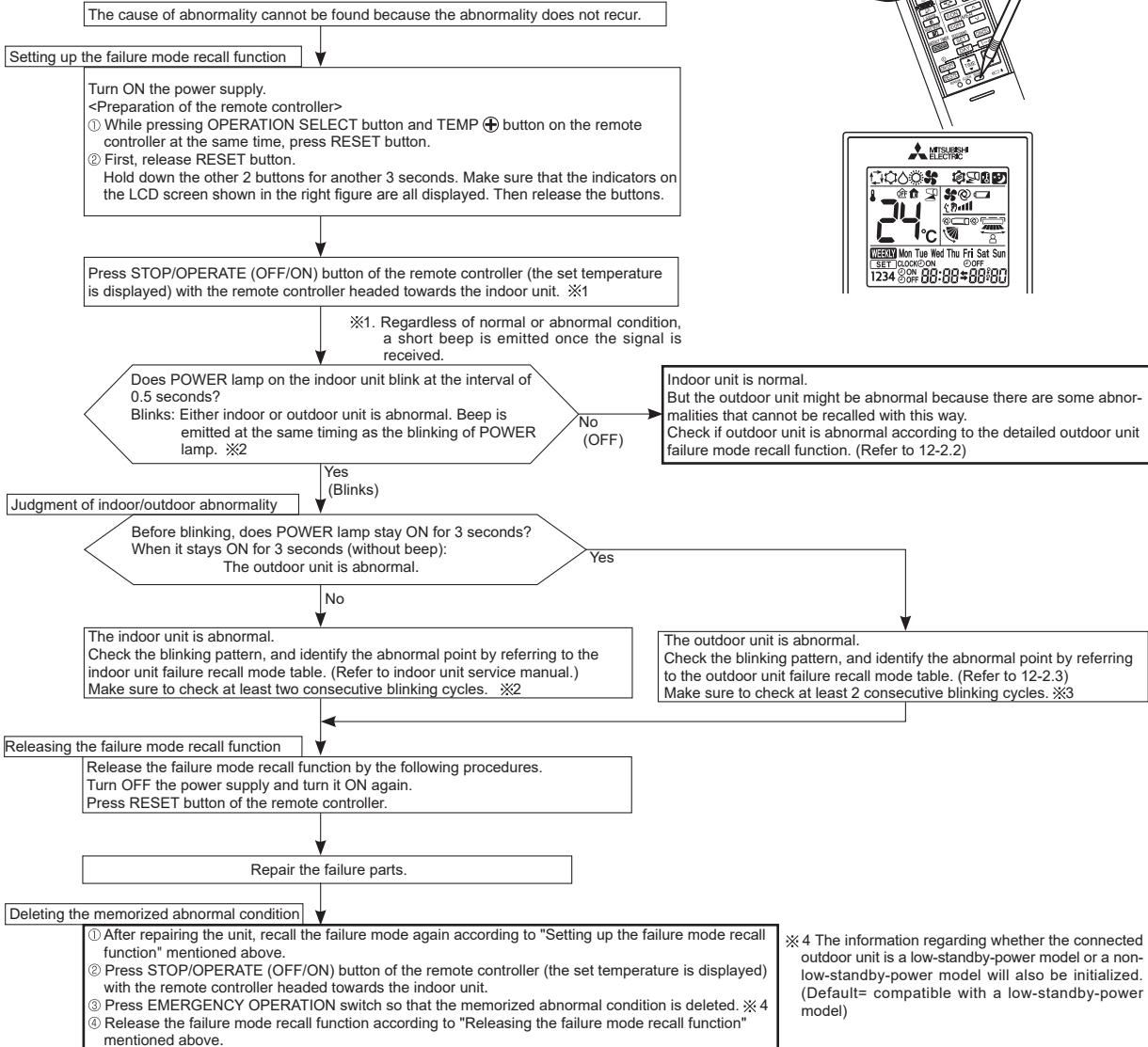

NOTE: 1. Make sure to release the failure mode recall function after it is set up, otherwise the unit cannot operate properly.
2. If the abnormal condition is not deleted from the memory, the last abnormal condition is kept memorized.

※2. Blinking pattern when the indoor unit is abnormal:

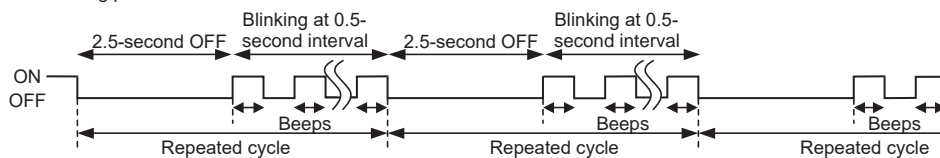

※3. Blinking pattern when the outdoor unit is abnormal:

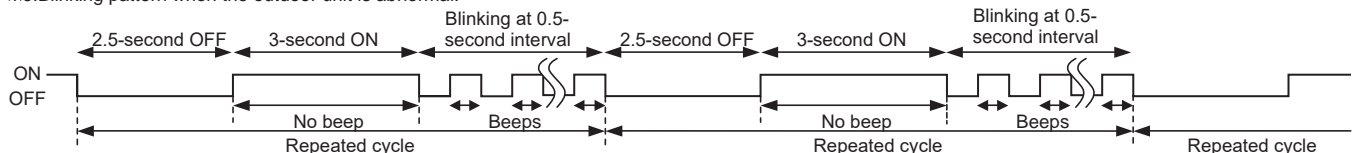

2. Flow chart of the detailed outdoor unit failure mode recall function

Operational procedure

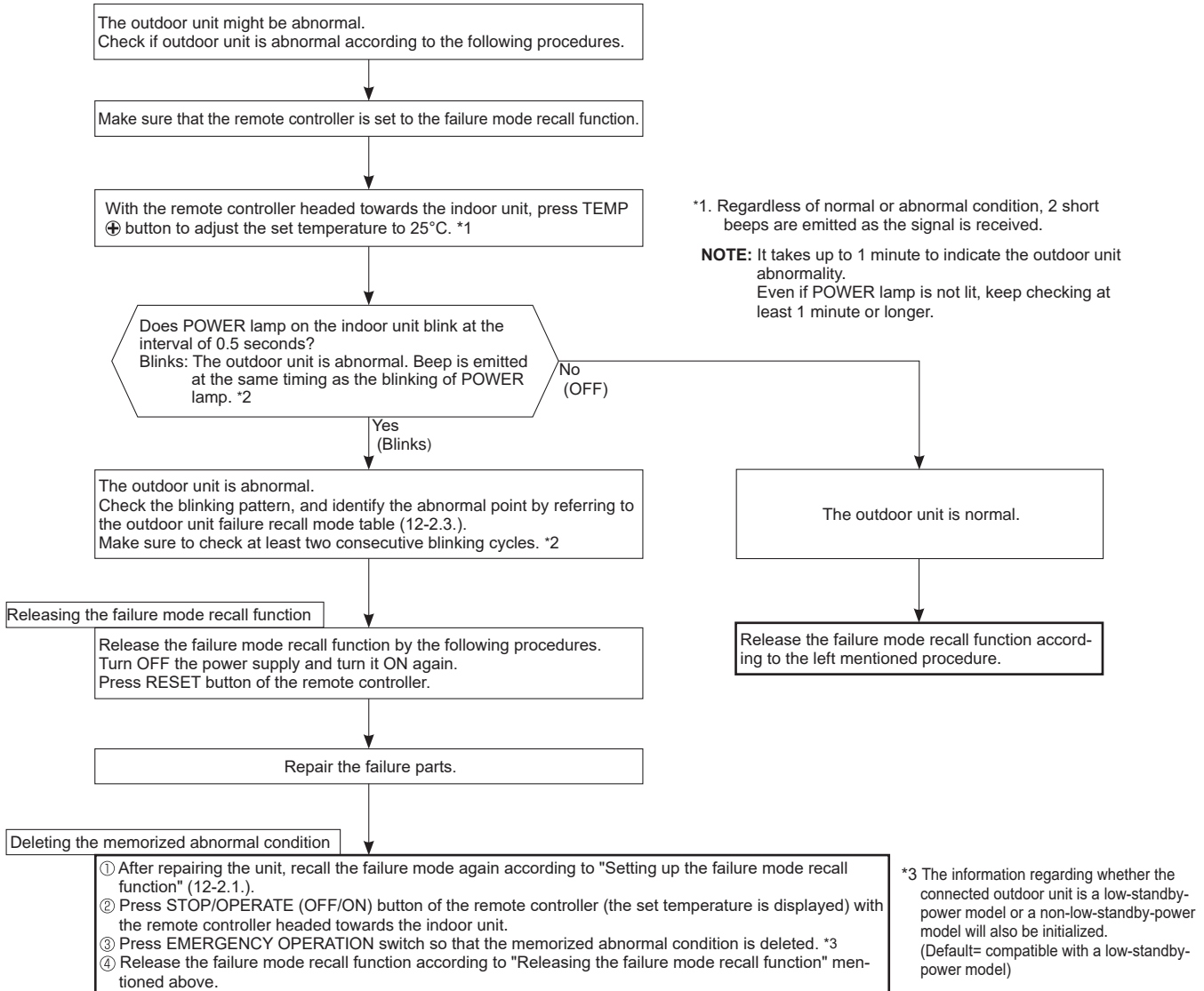

NOTE: 1. Make sure to release the failure mode recall function after it is set up, otherwise the unit cannot operate properly.
2. If the abnormal condition is not deleted from the memory, the last abnormal condition is kept memorized.

※2. Blinking pattern when outdoor unit is abnormal:

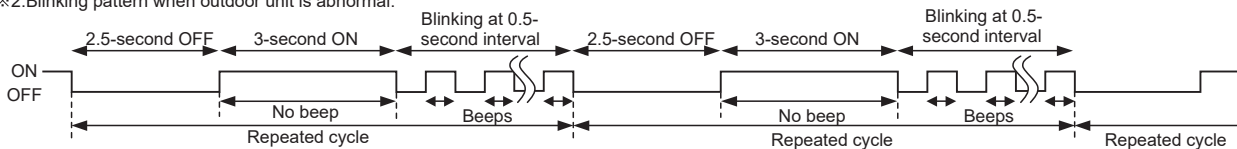



NOTE: Blinking patterns of this mode differ from the ones of TROUBLESHOOTING CHECK TABLE (12-3.).

3. Outdoor unit failure recall mode table

POWER lamp (Indoor unit)	Abnormal point (Failure mode/protection)	LED indication (Outdoor P.C. board)	Condition	Remedy	Indoor/outdoor unit failure mode recall function	Outdoor unit failure mode recall function
OFF	None (Normal)	—	—	—	—	—
1-time blink 2.5 seconds OFF	Indoor/outdoor communication, receiving error	—	Any signals from the inverter P.C. board cannot be received normally for 3 minutes.	•Refer to 12-5. ㉔ How to check miswiring and serial signal error.	○	○
	Indoor/outdoor communication, receiving error	—	Although the inverter P.C. board sends signal "0", signal "1" has been received 30 consecutive times.	•Refer to 12-5. ㉔ How to check miswiring and serial signal error.		
2-time blink 2.5 seconds OFF	Outdoor power system	—	Overcurrent protection cut-out operates 3 consecutive times within 1 minute after the compressor gets started.	•Reconnect connectors. •Refer to 12-5. ㉔ How to check inverter/compressor". •Check stop valve.	○	○
3-time blink 2.5 seconds OFF	Discharge temperature thermistor	1-time blink every 2.5 seconds	Thermistor shorts or opens during compressor running.	•Refer to 12-5. ㉔ "Check of outdoor thermistors". Defective outdoor thermistors can be identified by checking the blinking pattern of LED.	○	○
	Defrost thermistor					
	Fin temperature thermistor	3-time blink 2.5 seconds OFF				
	P.C. board temperature thermistor	4-time blink 2.5 seconds OFF				
	Ambient temperature thermistor	2-time blink 2.5 seconds OFF				
Outdoor heat exchanger temperature thermistor	—					
4-time blink 2.5 seconds OFF	Overcurrent	11-time blink 2.5 seconds OFF	Large current flows into power module (IC700).	•Reconnect compressor connector. •Refer to 12-5. ㉔ How to check inverter/compressor". •Check stop valve.	—	○
	Compressor synchronous abnormality (Compressor startup failure protection)	12-time blink 2.5 seconds OFF	Waveform of compressor current is distorted.	•Reconnect compressor connector. •Refer to 12-5. ㉔ How to check inverter/compressor".	—	○
5-time blink 2.5 seconds OFF	Discharge temperature	—	Temperature of discharge temperature thermistor exceeds 116°C, compressor stops. Compressor can restart if discharge temperature thermistor reads 100°C or less 3 minutes later.	•Check refrigerant circuit and refrigerant amount. •Refer to 12-5. ㉔ Check of LEV".	—	○
6-time blink 2.5 seconds OFF	High pressure	—	Temperature of indoor coil thermistor exceeds 70°C in HEAT mode. Temperature of defrost thermistor exceeds 70°C in COOL mode.	•Check refrigerant circuit and refrigerant amount. •Check stop valve.	—	○
7-time blink 2.5 seconds OFF	Fin temperature/P.C. board temperature	7-time blink 2.5 seconds OFF	Temperature of fin temperature thermistor on the inverter P.C. board exceeds 75 ~ 86°C (LN25/35/50) / 75 ~ 80°C (LN60), or temperature of P.C. board temperature thermistor on the inverter P.C. board exceeds 72 ~ 85°C (LN25/35/50) / 70 ~ 75°C (LN60).	•Check around outdoor unit. •Check outdoor unit air passage. •Refer to 12-5. ㉔ Check of outdoor fan motor".	—	○
8-time blink 2.5 seconds OFF	Outdoor fan motor	—	Outdoor fan has stopped 3 times in a row within 30 seconds after outdoor fan startup.	•Refer to 12-5. ㉔ Check of outdoor fan motor". Refer to 12-5. ㉔ Check of inverter P.C. board".	—	○
9-time blink 2.5 seconds OFF	Nonvolatile memory data	5-time blink 2.5 seconds OFF	Nonvolatile memory data cannot be read properly.	•Replace the inverter P.C. board.	○	○
	Power module (IC700)	6-time blink 2.5 seconds OFF	The interface short circuit occurs in the output of the power module (IC700). The compressor winding shorts circuit.	•Refer to 12-5. ㉔ How to check inverter/compressor".		

NOTE: Blinking patterns of this mode differ from the ones of TROUBLESHOOTING CHECK TABLE (12-3.).

POWER lamp (Indoor unit)	Abnormal point (Failure mode/protection)	LED indication (Outdoor P.C. board)	Condition	Remedy	Indoor/outdoor unit failure mode recall function	Outdoor unit failure mode recall function
10-time blink 2.5 seconds OFF	Discharge temperature	—	Temperature of discharge temperature thermistor has been 50°C or less for 20 minutes.	<ul style="list-style-type: none"> Refer to 12-5.⑧"Check of LEV". Check refrigerant circuit and refrigerant amount. 	—	○
11-time blink 2.5 seconds OFF	Bus-bar voltage (DC)	8-time blink 2.5 seconds OFF	Bus-bar voltage of inverter cannot be detected normally.	<ul style="list-style-type: none"> Refer to 12-5.⑨"How to check inverter/compressor". 	—	○
	Each phase current of compressor	9-time blink 2.5 seconds OFF	Each phase current of compressor cannot be detected normally.			
14-time blink 2.5 seconds OFF	Stop valve (Closed valve)	14-time blink 2.5 seconds OFF	Closed valve is detected by compressor current.	<ul style="list-style-type: none"> Check stop valve. 	○	○
	4-way valve/ Pipe temperature	16-time blink 2.5 seconds OFF	The 4-way valve does not work properly. The indoor coil thermistor detects an abnormal temperature.	<ul style="list-style-type: none"> Check the 4-way valve. Replace the inverter P.C. board. 		
16-time blink 2.5 seconds OFF	Outdoor refrigerant system abnormality	1-time blink 2.5 seconds OFF	A closed valve and air trapped in the refrigerant circuit are detected based on the temperature sensed by the indoor and outdoor thermistors and the current of the compressor.	<ul style="list-style-type: none"> Check for a gas leak in a connecting piping etc. Check the stop valve. Refer to 12-5. ⑩ "Check of outdoor refrigerant circuit". 	○	○

12-3. TROUBLESHOOTING CHECK TABLE

No.	Symptom	LED indication	Abnormal point/ Condition	Condition		Remedy	
1		1-time blink every 2.5 seconds	Outdoor power system	Overcurrent protection cut-out operates 3 consecutive times within 1 minute after the compressor gets started.		<ul style="list-style-type: none"> •Reconnect connector of compressor. •Refer to 12-5.Ⓐ "How to check inverter/compressor". •Check stop valve. 	
2			Outdoor thermistors	Discharge temperature thermistor, fin temperature thermistor, defrost thermistor, P.C. board temperature thermistor, outdoor heat exchanger temperature thermistor or ambient temperature thermistor shorts or opens during compressor running.		<ul style="list-style-type: none"> •Refer to 12-5.Ⓒ "Check of outdoor thermistors". 	
3			Outdoor control system	Nonvolatile memory data cannot be read properly. (POWER lamp of the indoor unit lights up or blinks 7-time.)		<ul style="list-style-type: none"> •Replace inverter P.C. board. 	
4		6-time blink 2.5 seconds OFF	Serial signal	The communication fails between the indoor and outdoor unit for 3 minutes.		<ul style="list-style-type: none"> •Refer to 12-5.Ⓜ "How to check miswiring and serial signal error. 	
5		11-time blink 2.5 seconds OFF	Stop valve/ Closed valve	Closed valve is detected by compressor current.		<ul style="list-style-type: none"> •Check stop valve. 	
6		14-time blink 2.5 seconds OFF	Outdoor unit (Other abnormality)	Outdoor unit is defective.		<ul style="list-style-type: none"> •Refer to 12-2.2. "Flow chart of the detailed outdoor unit failure mode recall function". 	
7		16-time blink 2.5 seconds OFF	4-way valve/ Pipe temperature	The 4-way valve does not work properly. The indoor coil thermistor detects an abnormal temperature.		<ul style="list-style-type: none"> •Refer to 12-5.Ⓔ "Check of R.V. coil". •Replace the inverter P.C. board. 	
8		17-time blink 2.5 seconds OFF	Outdoor refrigerant system abnormality	A closed valve and air trapped in the refrigerant circuit are detected based on the temperature sensed by the indoor and outdoor thermistors and the current of the compressor.		<ul style="list-style-type: none"> •Check for a gas leak in a connecting piping etc. •Check the stop valve. •Refer to 12-5.Ⓝ "Check of outdoor refrigerant circuit". 	
9	'Outdoor unit stops and restarts 3 minutes later' is repeated.	2-time blink 2.5 seconds OFF	Overcurrent protection	Large current flows into power module (IC700).		<ul style="list-style-type: none"> •Reconnect connector of compressor. •Refer to 12-5.Ⓐ "How to check inverter/compressor". •Check stop valve. 	
10		3-time blink 2.5 seconds OFF	Discharge temperature overheat protection	Temperature of discharge temperature thermistor exceeds 116°C, compressor stops. Compressor can restart if discharge temperature thermistor reads 100°C or less 3 minutes later.		<ul style="list-style-type: none"> •Check refrigerant circuit and refrigerant amount. •Refer to 12-5.Ⓚ "Check of LEV". 	
11		4-time blink 2.5 seconds OFF	Fin temperature / P.C. board temperature thermistor overheat protection	Temperature of fin temperature thermistor on the heat sink exceeds 75 ~ 86°C (LN25/35/50)/75 ~ 80°C (LN60) or temperature of P.C. board temperature thermistor on the inverter P.C. board exceeds 72 ~ 85°C (LN25/35/50)/70 ~ 75°C (LN60).		<ul style="list-style-type: none"> •Check around outdoor unit. •Check outdoor unit air passage. •Refer to 12-5.Ⓛ "Check of outdoor fan motor". 	
12		5-time blink 2.5 seconds OFF	High pressure protection	Indoor coil thermistor exceeds 70°C in HEAT mode. Defrost thermistor exceeds 70°C in COOL mode.		<ul style="list-style-type: none"> •Check refrigerant circuit and refrigerant amount. •Check stop valve. 	
13		8-time blink 2.5 seconds OFF	Compressor synchronous abnormality	The waveform of compressor current is distorted.		<ul style="list-style-type: none"> •Reconnect connector of compressor. •Refer to 12-5.Ⓐ "How to check inverter/compressor". 	
14		10-time blink 2.5 seconds OFF	Outdoor fan motor	Outdoor fan has stopped 3 times in a row within 30 seconds after outdoor fan startup.		<ul style="list-style-type: none"> •Refer to 12-5.Ⓛ "Check of outdoor fan motor. •Refer to 12-5.Ⓛ "Check of inverter P.C. board. 	
15		12-time blink 2.5 seconds OFF	Each phase current of compressor	Each phase current of compressor cannot be detected normally.		<ul style="list-style-type: none"> •Refer to 12-5.Ⓐ "How to check inverter/compressor". 	
16		13-time blink 2.5 seconds OFF	Bus-bar voltage (DC)	Bus-bar voltage of inverter cannot be detected normally.		<ul style="list-style-type: none"> •It occurs with following case. Instantaneous power voltage drop. (Short time power failure) (LN60) •Refer to 12-5.Ⓞ "Check of power supply". (LN60) •Refer to 12-5.Ⓐ "How to check inverter/compressor". 	
17		Outdoor unit operates.	1-time blink 2.5 seconds OFF	Frequency drop by current protection	LN25/35/50	When the input current exceeds approximately 10A, compressor frequency lowers.	<ul style="list-style-type: none"> •The unit is normal, but check the following. •Check if indoor filters are clogged. •Check if refrigerant is short. •Check if indoor/outdoor unit air circulation is short cycled.
18					LN60	Current from power outlet is nearing breaker capacity.	
18		3-time blink 2.5 seconds OFF	Frequency drop by high pressure protection	Temperature of indoor coil thermistor exceeds 55°C in HEAT mode, compressor frequency lowers.			
			Frequency drop by defrosting in COOL mode	Indoor coil thermistor reads 8°C or less in COOL mode, compressor frequency lowers.			
19		4-time blink 2.5 seconds OFF	Frequency drop by discharge temperature protection	Temperature of discharge temperature thermistor exceeds 111°C, compressor frequency lowers.		<ul style="list-style-type: none"> •Check refrigerant circuit and refrigerant amount. •Refer to 12-5.Ⓚ "Check of LEV". •Refer to 12-5.Ⓒ "Check of outdoor thermistors". 	
20		MUZ-LN25/35 5-time blink 2.5 seconds OFF	Outside temperature thermistor protection	When the outside temperature thermistor shorts or opens, protective operation without that thermistor is performed.		<ul style="list-style-type: none"> •Refer to 12-5.Ⓒ Check of outdoor thermistors. 	



No.	Symptom	LED indication	Abnormal point/ Condition	Condition	Remedy
21	Outdoor unit operates.	7-time flash 2.5 seconds OFF	Low discharge temperature protection	Temperature of discharge temperature thermistor has been 50°C or less for 20 minutes.	<ul style="list-style-type: none"> Refer to 12-5.⑧ "Check of LEV". Check refrigerant circuit and refrigerant amount.
22		8-time flash 2.5 seconds OFF	MUZ-LN25/35/50 PAM protection PAM: Pulse Amplitude Modulation	The overcurrent flows into PFC (Power factor correction: IC820) or the bus-bar voltage reaches 394 V or more, PAM stops and restarts.	This is not malfunction. PAM protection will be activated in the following cases: 1 Instantaneous power voltage drop. (Short time power failure) 2 When the power supply voltage is high.
			MUZ-LN60 Zero cross detecting circuit	Zero cross signal cannot be detected.	<ul style="list-style-type: none"> It occurs with following cases. 1 Instantaneous power voltage drop. (Short time power failure) 2 Distortion of primary voltage <ul style="list-style-type: none"> Refer to 12-5.⑨ "Check of power supply".
23	9-time flash 2.5 seconds OFF	Inverter check mode	The connector of compressor is disconnected, inverter check mode starts.	<ul style="list-style-type: none"> Check if the connector of the compressor is correctly connected. Refer to 12-5.⑩ "How to check inverter/compressor". 	

NOTE: 1. The location of LED is illustrated at the right figure. Refer to 12-6.1.
2. LED is lit during normal operation.

The flashing frequency shows the number of times the LED blinks after every 2.5-second OFF.
(Example) When the flashing frequency is "2".

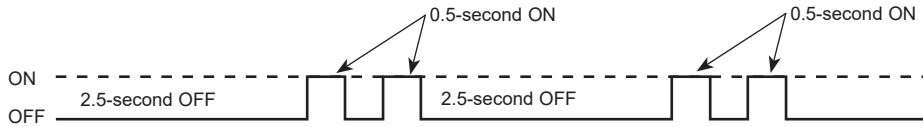

Inverter P.C. board
MUZ-LN25/35/50VG
MUZ-LN25/35/50VG2

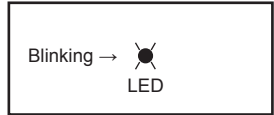

MUZ-LN60VG

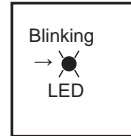

12-4. TROUBLE CRITERION OF MAIN PARTS

**MUZ-LN25VG MUZ-LN35VG MUZ-LN50VG MUZ-LN60VG
 MUZ-LN25VG2 MUZ-LN35VG2 MUZ-LN50VG2**

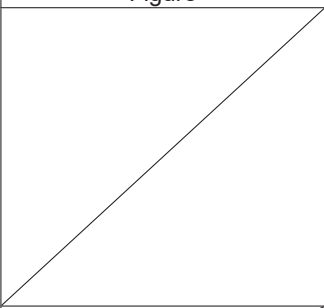
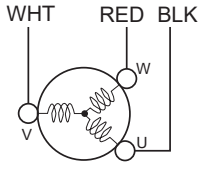
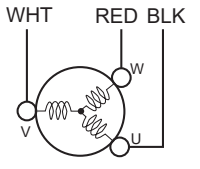
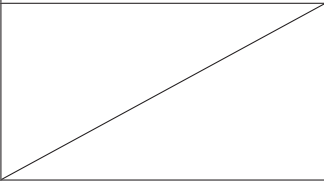
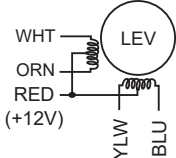
Part name	Check method and criterion	Figure																								
Defrost thermistor (RT61) Fin temperature thermistor (RT64) Ambient temperature thermistor (RT65) Outdoor heat exchanger temperature thermistor (RT68)	Measure the resistance with a tester. Refer to 12-6. "Test point diagram and voltage", 1. "Inverter P.C. board", for the chart of thermistor.																									
Discharge temperature thermistor (RT62)	Measure the resistance with a tester. Before measurement, hold the thermistor with your hands to warm it up. Refer to 12-6. "Test point diagram and voltage", 1. "Inverter P.C. board", for the chart of thermistor.																									
Compressor	Measure the resistance between terminals using a tester. (Temperature: -10 ~ 40°C) <table border="1" style="width: 100%; text-align: center;"> <thead> <tr> <th rowspan="2"></th> <th colspan="4">Normal (Ω)</th> </tr> <tr> <th>MUZ-LN25VG MUZ-LN25VG2</th> <th>MUZ-LN35VG MUZ-LN35VG2</th> <th>MUZ-LN50VG MUZ-LN50VG2</th> <th>MUZ-LN60VG</th> </tr> </thead> <tbody> <tr> <td>U-V</td> <td></td> <td></td> <td></td> <td></td> </tr> <tr> <td>U-W</td> <td>1.59 - 2.16</td> <td>1.60 - 2.17</td> <td>0.82 - 1.11</td> <td>0.87 - 1.18</td> </tr> <tr> <td>V-W</td> <td></td> <td></td> <td></td> <td></td> </tr> </tbody> </table>		Normal (Ω)				MUZ-LN25VG MUZ-LN25VG2	MUZ-LN35VG MUZ-LN35VG2	MUZ-LN50VG MUZ-LN50VG2	MUZ-LN60VG	U-V					U-W	1.59 - 2.16	1.60 - 2.17	0.82 - 1.11	0.87 - 1.18	V-W					
	Normal (Ω)																									
	MUZ-LN25VG MUZ-LN25VG2	MUZ-LN35VG MUZ-LN35VG2	MUZ-LN50VG MUZ-LN50VG2	MUZ-LN60VG																						
U-V																										
U-W	1.59 - 2.16	1.60 - 2.17	0.82 - 1.11	0.87 - 1.18																						
V-W																										
Outdoor fan motor	Measure the resistance between lead wires using a tester. (Temperature: -10 ~ 40°C) <table border="1" style="width: 100%; text-align: center;"> <thead> <tr> <th rowspan="2">Color of lead wire</th> <th colspan="3">Normal (Ω)</th> </tr> <tr> <th>MUZ-LN25/35/50VG MUZ-LN50VG2</th> <th>MUZ-LN25/35VG2</th> <th>MUZ-LN60VG</th> </tr> </thead> <tbody> <tr> <td>RED - BLK</td> <td></td> <td></td> <td></td> </tr> <tr> <td>BLK - WHT</td> <td>15 - 20</td> <td>32 - 43</td> <td>25 - 34</td> </tr> <tr> <td>WHT - RED</td> <td></td> <td></td> <td></td> </tr> </tbody> </table>	Color of lead wire	Normal (Ω)			MUZ-LN25/35/50VG MUZ-LN50VG2	MUZ-LN25/35VG2	MUZ-LN60VG	RED - BLK				BLK - WHT	15 - 20	32 - 43	25 - 34	WHT - RED									
Color of lead wire	Normal (Ω)																									
	MUZ-LN25/35/50VG MUZ-LN50VG2	MUZ-LN25/35VG2	MUZ-LN60VG																							
RED - BLK																										
BLK - WHT	15 - 20	32 - 43	25 - 34																							
WHT - RED																										
R. V. coil (21S4)	Measure the resistance using a tester. (Temperature: -10 ~ 40°C) <table border="1" style="width: 100%; text-align: center;"> <thead> <tr> <th colspan="2">Normal (kΩ)</th> </tr> <tr> <th>MUZ-LN25/35/50VG MUZ-LN25/35/50VG2</th> <th>MUZ-LN60VG</th> </tr> </thead> <tbody> <tr> <td>1.41 - 2.00</td> <td>1.17 - 1.66</td> </tr> </tbody> </table>	Normal (kΩ)		MUZ-LN25/35/50VG MUZ-LN25/35/50VG2	MUZ-LN60VG	1.41 - 2.00	1.17 - 1.66																			
Normal (kΩ)																										
MUZ-LN25/35/50VG MUZ-LN25/35/50VG2	MUZ-LN60VG																									
1.41 - 2.00	1.17 - 1.66																									
Expansion valve coil (LEV)	Measure the resistance using a tester. (Temperature: -10 ~ 40°C) <table border="1" style="width: 100%; text-align: center;"> <thead> <tr> <th>Color of lead wire</th> <th>Normal (Ω)</th> </tr> </thead> <tbody> <tr> <td>RED - ORN</td> <td rowspan="5">37 - 54</td> </tr> <tr> <td>RED - WHT</td> </tr> <tr> <td>RED - BLU</td> </tr> <tr> <td>RED - YLW</td> </tr> <tr> <td>RED - YLW</td> </tr> </tbody> </table>	Color of lead wire	Normal (Ω)	RED - ORN	37 - 54	RED - WHT	RED - BLU	RED - YLW	RED - YLW																	
Color of lead wire	Normal (Ω)																									
RED - ORN	37 - 54																									
RED - WHT																										
RED - BLU																										
RED - YLW																										
RED - YLW																										

12-5. TROUBLESHOOTING FLOW

A How to check inverter/compressor

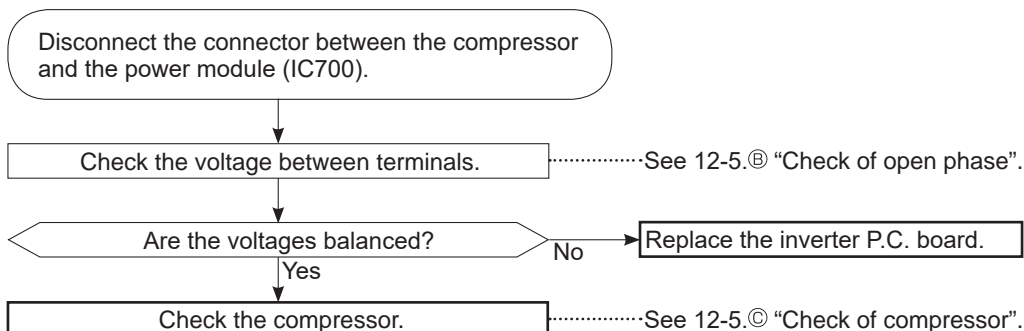

B Check of open phase

- With the connector between the compressor and the power module (IC700) disconnected, activate the inverter and check if the inverter is normal by measuring **the voltage balance** between the terminals.

Output voltage is 50 - 130 V. (The voltage may differ according to the tester.)

<< Operation method >>

Start cooling or heating operation by pressing EMERGENCY OPERATION switch on the indoor unit. (TEST RUN OPERATION: Refer to 9-3.)

<< Measurement point >>

At 3 points

BLK (U)-WHT (V) ※ Measure AC voltage between the lead wires at 3 points.

BLK (U)-RED (W)

WHT(V)-RED (W)

- NOTE:** 1. Output voltage varies according to power supply voltage.
 2. Measure the voltage by analog type tester.
 3. During this check, LED of the inverter P.C. board blinks 9 times. (Refer to 12-6.1.)

C Check of compressor

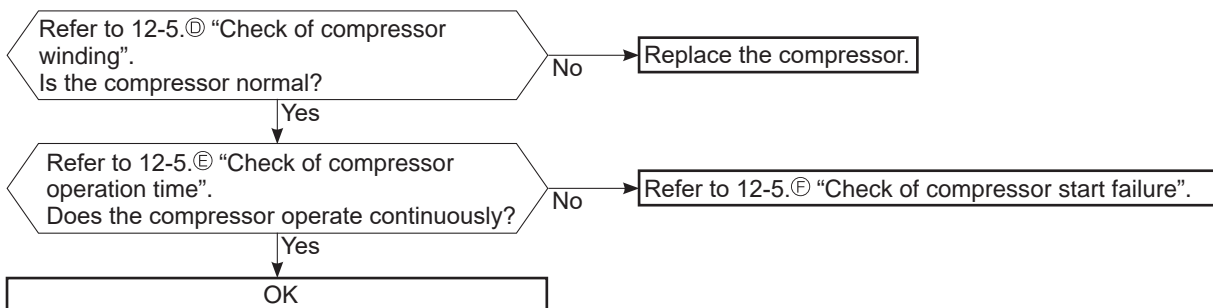

D Check of compressor winding

- Disconnect the connector between the compressor and the power module (IC700), and measure the resistance between the compressor terminals.

<<Measurement point>>

At 3 points

BLK-WHT

BLK-RED

WHT-RED

※ Measure the resistance between the lead wires at 3 points.

<<Judgement>>

Refer to 12-4.

0 [Ω]Abnormal [short]

Infinite [Ω]Abnormal [open]

NOTE: Be sure to zero the ohmmeter before measurement.

E Check of compressor operation time

- Connect the compressor and activate the inverter. Then measure the time until the inverter stops due to overcurrent.

<<Operation method>>

Start heating or cooling operation by pressing EMERGENCY OPERATION switch on the indoor unit. (TEST RUN OPERATION: Refer to 9-3.)

<<Measurement>>

Measure the time from the start of compressor to the stop of compressor due to overcurrent.

<<Judgement>>

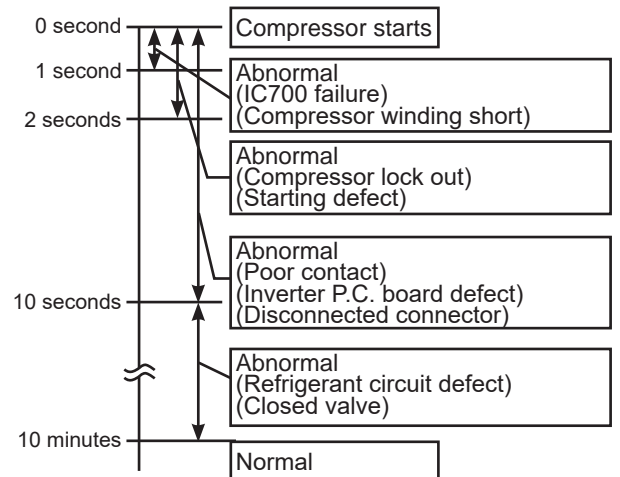

F Check of compressor start failure

Confirm that ①~④ is normal.

•Electrical circuit check

①. Contact of the compressor connector

②. Output voltage of inverter P.C. board and balance of them (See 12-5.⑥)

③. Direct current voltage between DB61(+) and (-) (**MUZ-LN25/35/50VG, MUZ-LN25/35/50VG2**)/IC700 (P) and (N) (**MUZ-LN60VG**) on the inverter P.C. board

④. Voltage between outdoor terminal block S1-S2

Does the compressor run for 10 seconds or more after it starts?

Yes

Check the refrigerant circuit.
Check the stop valve.

No

After the compressor is heated with a drier, does the compressor start? ※1

No

Replace the compressor.

Yes

Compressor start failure. Activate pre-heat control.
(Refer to 11-2. "PRE-HEAT CONTROL SETTING")

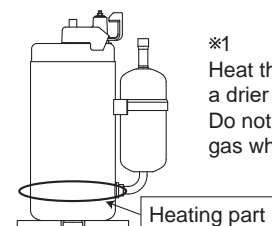

※1

Heat the compressor with a drier for about 20 minutes. Do not recover refrigerant gas while heating.

Ⓒ Check of outdoor thermistors

Disconnect the connector of thermistor in the inverter P.C. board (see below table), and measure the resistance of thermistor.

Is the resistance of thermistor normal?
(Refer to 12-6.1.)

No

Replace the thermistor except RT64.
When RT64 is abnormal, replace the inverter P.C. board.

Yes

Reconnect the connector of thermistor.
Turn ON the power supply and press EMERGENCY OPERATION switch.

Does the unit operate for 10 minutes or more
without showing thermistor abnormality?

No

Replace the inverter P.C. board.

Yes

OK (Cause is poor contact.)

MUZ-LN25/35/50VG MUZ-LN25/35/50VG2

Thermistor	Symbol	Connector, Pin No.	Board
Defrost	RT61	Between CN641 pin1 and pin2	Inverter P.C. board
Discharge temperature	RT62	Between CN641 pin3 and pin4	
Fin temperature	RT64	Between CN642 pin1 and pin2	
Ambient temperature	RT65	Between CN643 pin1 and pin2	
Outdoor heat exchanger temperature	RT68	Between CN644 pin1 and pin3	

MUZ-LN60VG

Thermistor	Symbol	Connector, Pin No.	Board
Defrost	RT61	Between CN671 pin1 and pin2	Inverter P.C. board
Discharge temperature	RT62	Between CN671 pin3 and pin4	
Fin temperature	RT64	Between CN673 pin1 and pin2	
Ambient temperature	RT65	Between CN672 pin1 and pin2	
Outdoor heat exchanger temperature	RT68	Between CN671 pin5 and pin6	

H Check of R.V. coil

MUZ-LN25/35/50VG MUZ-LN25/35/50VG2

- ※ First of all, measure the resistance of R.V. coil to check if the coil is defective. Refer to 12-4.
 - ※ In case CN721 is disconnected or R.V. coil is open, voltage is generated between the terminal pins of the connector although no signal is being transmitted to R.V. coil.
- Check if CN721 is connected.

Unit operates in COOL mode even if it is set to HEAT mode.

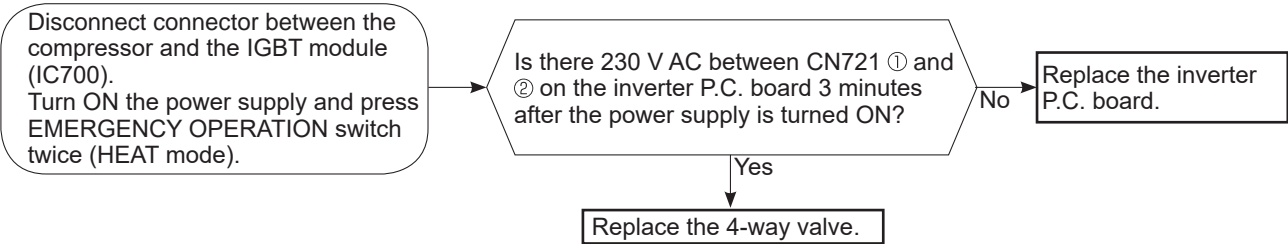

Unit operates in HEAT mode even if it is set to COOL mode.

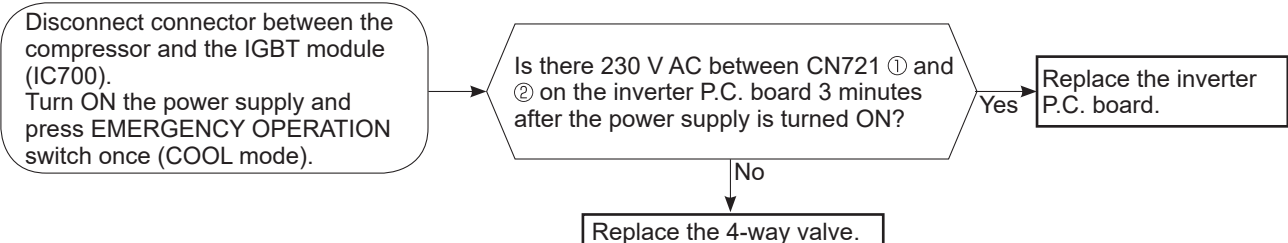

MUZ-LN60VG

- ※ First of all, measure the resistance of R.V. coil to check if the coil is defective. Refer to 11-4.
 - ※ In case CN602 is disconnected or R.V. coil is open, voltage is generated between the terminal pins of the connector although no signal is being transmitted to R.V. coil.
- Check if CN602 is connected.

Unit operates in COOL mode even if it is set to HEAT mode.

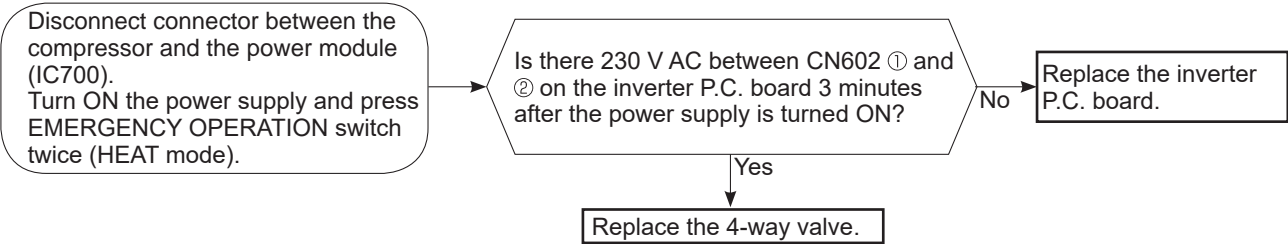

Unit operates in HEAT mode even if it is set to COOL mode.

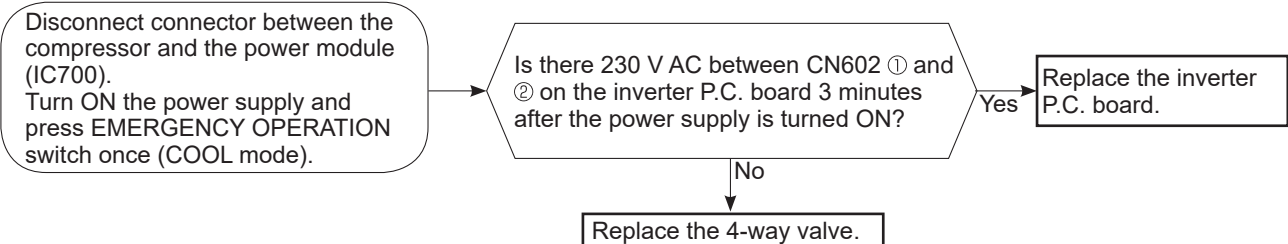

① Check of outdoor fan motor

Disconnect the connectors CN931 and CN932 from the inverter P.C. board.
Check the connection between the connector CN931 and CN932.

Is the resistance between each terminal of outdoor fan motor normal?
(Refer to 12-4.)

Yes

Disconnect CN932 from the inverter P.C. board, and turn on the power supply.

Rotate the outdoor fan motor manually and measure the voltage of CN931.
Between 1(+) and 5(-)
Between 2(+) and 5(-)
Between 3(+) and 5(-)

No

(Fixed to either 5 or 0 V DC)

Does the voltage between each terminal become 5 and 0 V DC repeatedly?

No

Yes

Does the outdoor fan motor rotate smoothly?

No

Yes

Replace the outdoor fan motor.

Replace the inverter P.C. board.

J Check of power supply

Disconnect the connector between the compressor and the power module (IC700). Turn ON power supply and press EMERGENCY OPERATION switch.

Does POWER lamp on the indoor unit light up?

Yes

Is there bus-bar voltage 260 - 370 V DC between DB61 (+) and DB61 (-) (MUZ-LN25/35/50VG, MUZ-LN25/35/50VG2)/325 - 370 V DC between IC700 (P) and (N) (MUZ-LN60VG) on the inverter P.C. board? (Refer to 12-6.1.)

No

Check the electric parts in main circuit.

No

Is there voltage 230 V AC between the indoor terminal block S1 and S2?

Yes

Rectify indoor/outdoor connecting wire.

Replace the indoor electronic control P.C. board.

Replace the inverter P.C. board.

Does LED on the inverter P.C. board light up or blink? (Refer to 12-6.1.)

Yes

If lights up, OK.
If blinks, refer to 12-3.

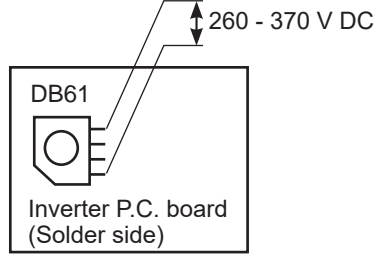

MUZ-LN25/35/50VG
MUZ-LN25/35/50VG2

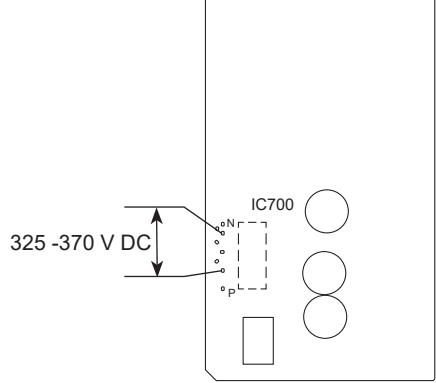

MUZ-LN60VG

K Check of LEV (Expansion valve)

MSZ-LN25/35VG
MSZ-LN50/60VG

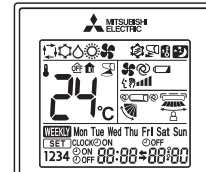
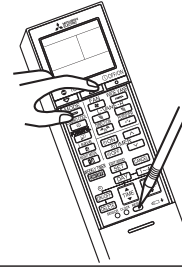

Turn ON the power supply.
<Preparation of the remote controller>
① While pressing both OPERATION SELECT button and TEMP \oplus button on the remote controller at the same time, press RESET button.
② First, release RESET button.
Hold down the other 2 buttons for another 3 seconds. Make sure that the indicators on the LCD screen shown in the right figure are all displayed. Then release the buttons.

Press STOP/OPERATE (OFF/ON) button of the remote controller (the set temperature is displayed) with the remote controller headed towards the indoor unit. ※1

Expansion valve operates in full-opening direction.

Do you hear the expansion valve "click, click....." ?
Do you feel the expansion valve vibrate when touching it ?

Yes

OK

No

Is LEV coil properly fixed to the expansion valve?

No

Properly fix the LEV coil to the expansion valve.

Yes

Does the resistance of LEV coil have the characteristics? (Refer to 12-4.)

Yes

Measure each voltage between connector pins of CN724 on the inverter P.C. board.
1. Pin③(-) — Pin①(+)
2. Pin④(-) — Pin①(+)
3. Pin⑤(-) — Pin①(+)
4. Pin⑥(-) — Pin①(+)
Is there about 3 - 5 V AC between each?
NOTE: Measure the voltage by an analog tester.

No

Replace the inverter P.C. board.

No

Replace the LEV coil.

Yes

Replace the expansion valve.

※1. Regardless of normal or abnormal condition, a short beep is emitted once the signal is received.

NOTE: After check of LEV, take the following steps.

1. Turn OFF the power supply and turn it ON again.
2. Press RESET button on the remote controller.

L Check of inverter P.C. board

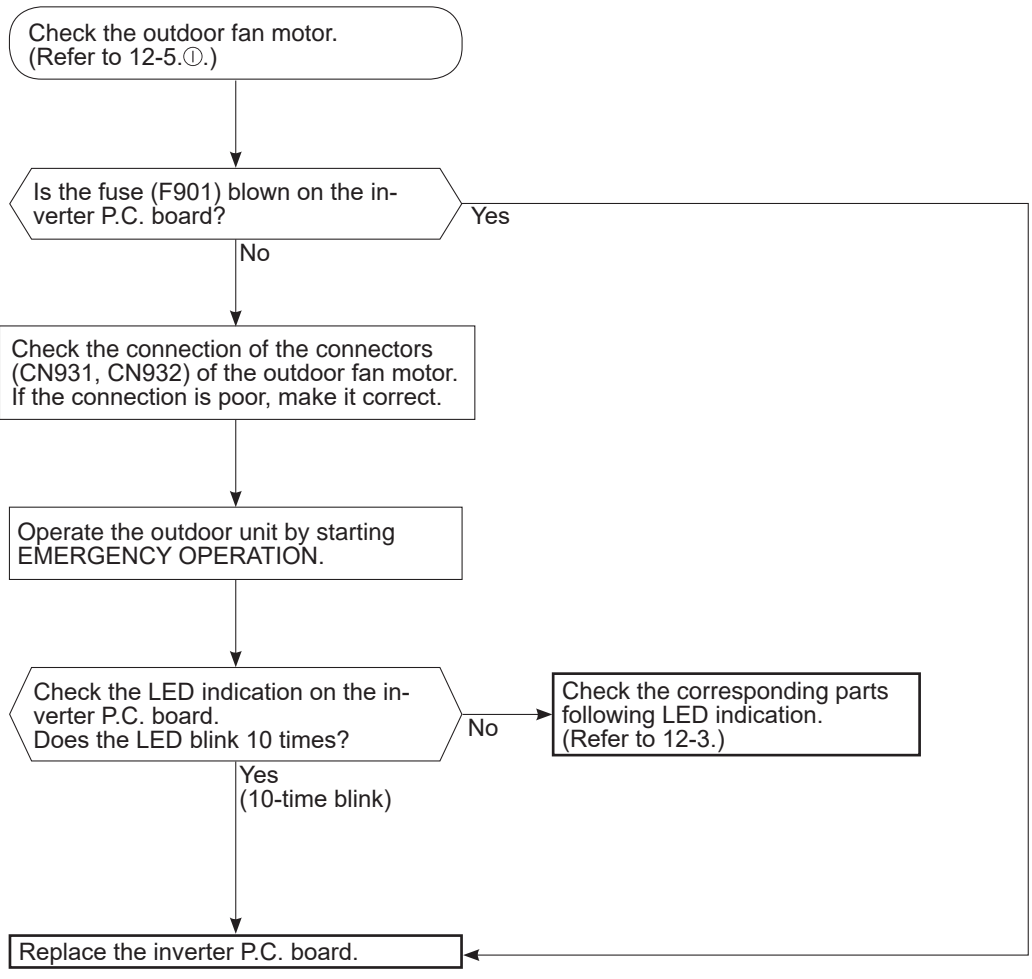

M How to check miswiring and serial signal error

NOTE: Refer to the indoor unit service manual.

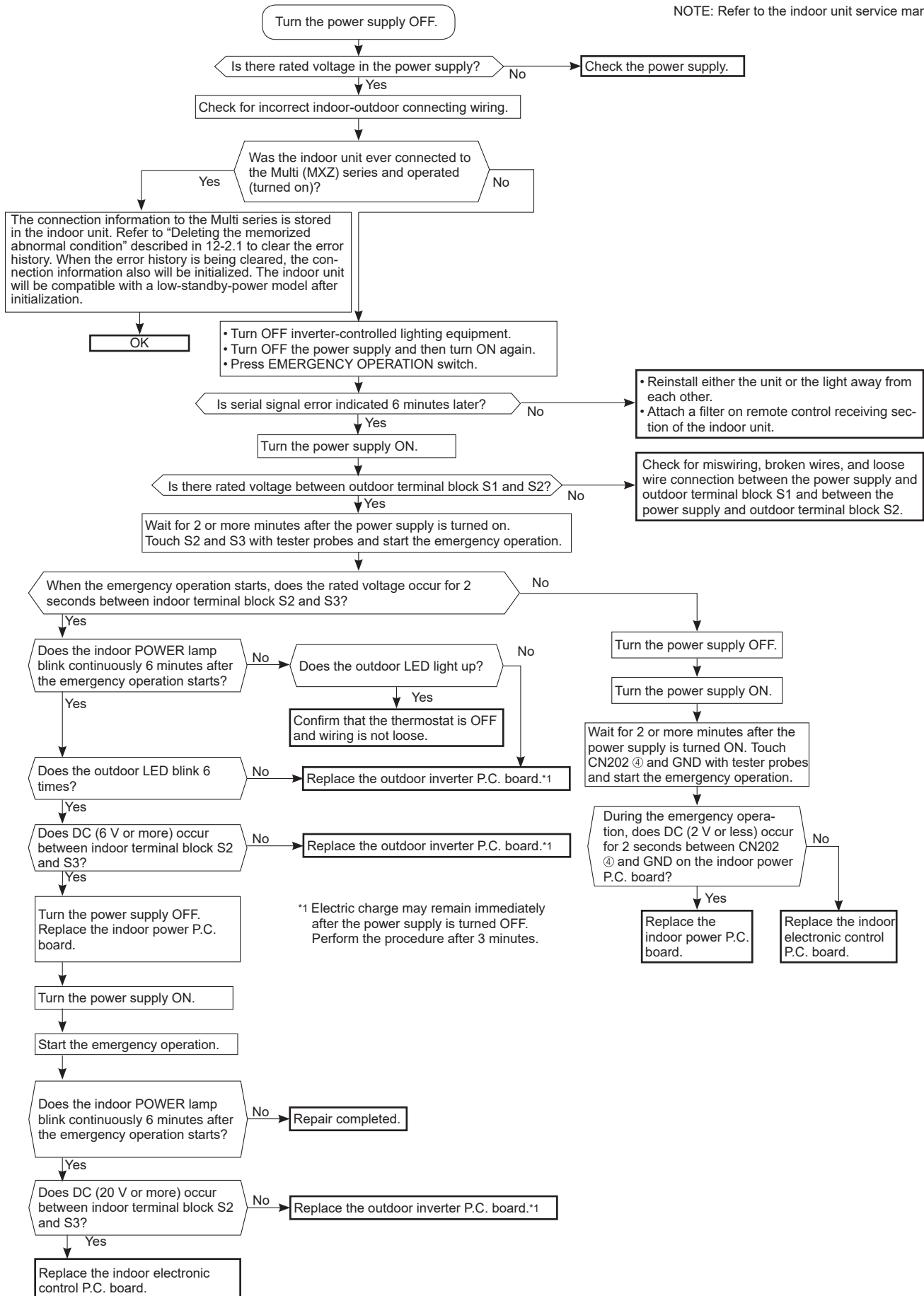

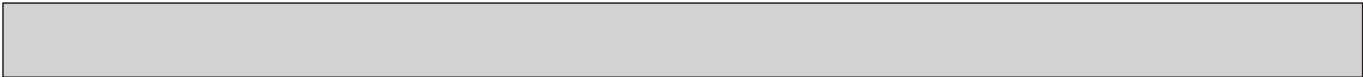

N Check of the outdoor refrigerant circuit

Has the operation stopped during pump down?

Yes

The operation has stopped to prevent the diesel explosion caused by air trapped in the refrigerant circuit. Close the stop valve, and disconnect the power plug or turn the breaker OFF.

CAUTION:
Do not start the operation again to prevent hazards.

No

Was the operation started with the stop valve closed, and was it opened during operation?

Yes

The unit occasionally stops when the stop valve is opened or closed during operation. Open the stop valve and start the cooling operation again.

No

The refrigerant gas amount may be 60% or less than the normal amount. Identify where the gas is leaking from, and fix the leak.

⊙ Electromagnetic noise enters into TV sets or radios

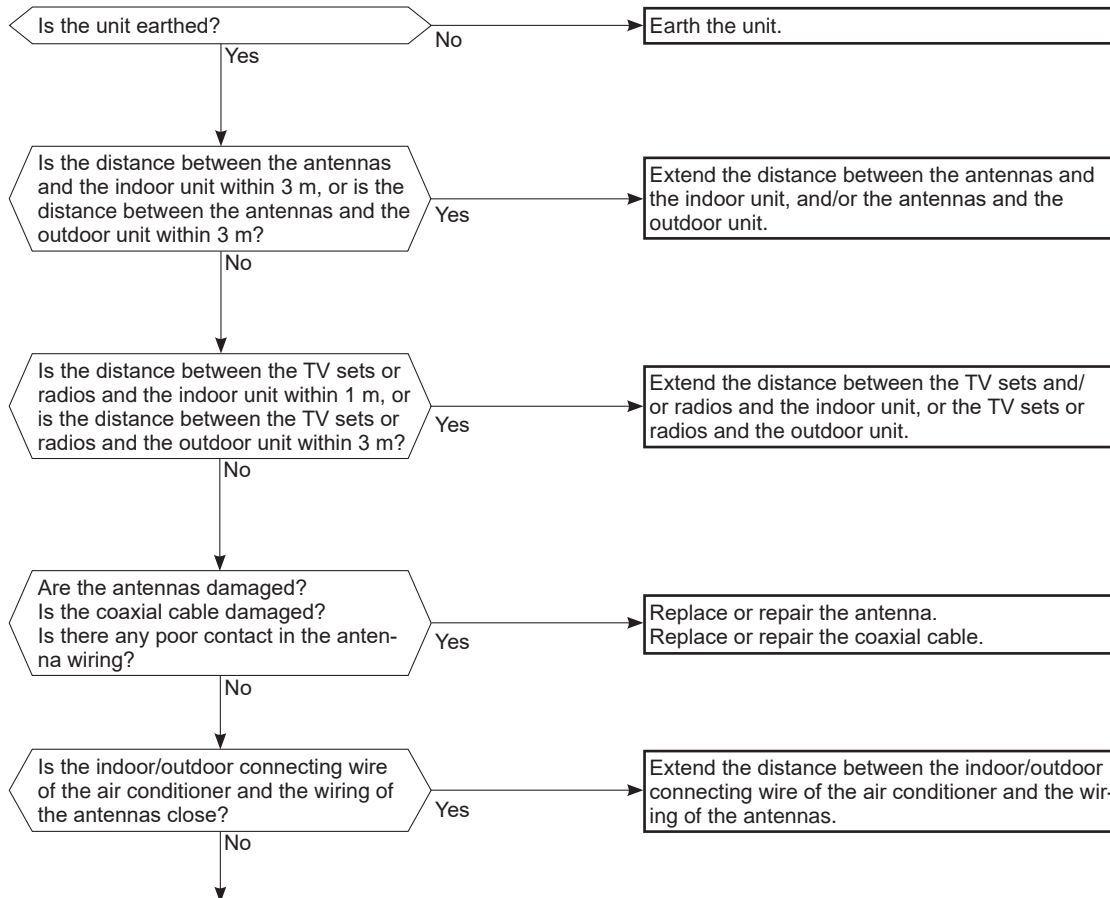

Even if all of the above conditions are fulfilled, the electromagnetic noise may enter, depending on the electric field strength or the installation condition (combination of specific conditions such as antennas or wiring).
Check the following before asking for service.

1. Devices affected by the electromagnetic noise
TV sets, radios (FM/AM broadcast, shortwave)
2. Channel, frequency, broadcast station affected by the electromagnetic noise
3. Channel, frequency, broadcast station unaffected by the electromagnetic noise
4. Layout of:
indoor/outdoor unit of the air conditioner, indoor/outdoor wiring, earth wire, antennas, wiring from antennas, receiver
5. Electric field intensity of the broadcast station affected by the electromagnetic noise
6. Presence or absence of amplifier such as booster
7. Operation condition of air conditioner when the electromagnetic noise enters in
 - 1) Turn OFF the power supply once, and then turn ON the power supply. In this situation, check for the electromagnetic noise.
 - 2) Within 3 minutes after turning ON the power supply, press STOP/OPERATE (OFF/ON) button on the remote controller for power ON, and check for the electromagnetic noise.
 - 3) After a short time (3 minutes later after turning ON), the outdoor unit starts running. During operation, check for the electromagnetic noise.
 - 4) Press STOP/OPERATE (OFF/ON) button on the remote controller for power OFF, when the outdoor unit stops but the indoor/outdoor communication still runs on. In this situation, check for the electromagnetic noise.

12-6. TEST POINT DIAGRAM AND VOLTAGE

1. Inverter P.C. board

MUZ-LN25VG

MUZ-LN35VG

MUZ-LN50VG

MUZ-LN50VG2

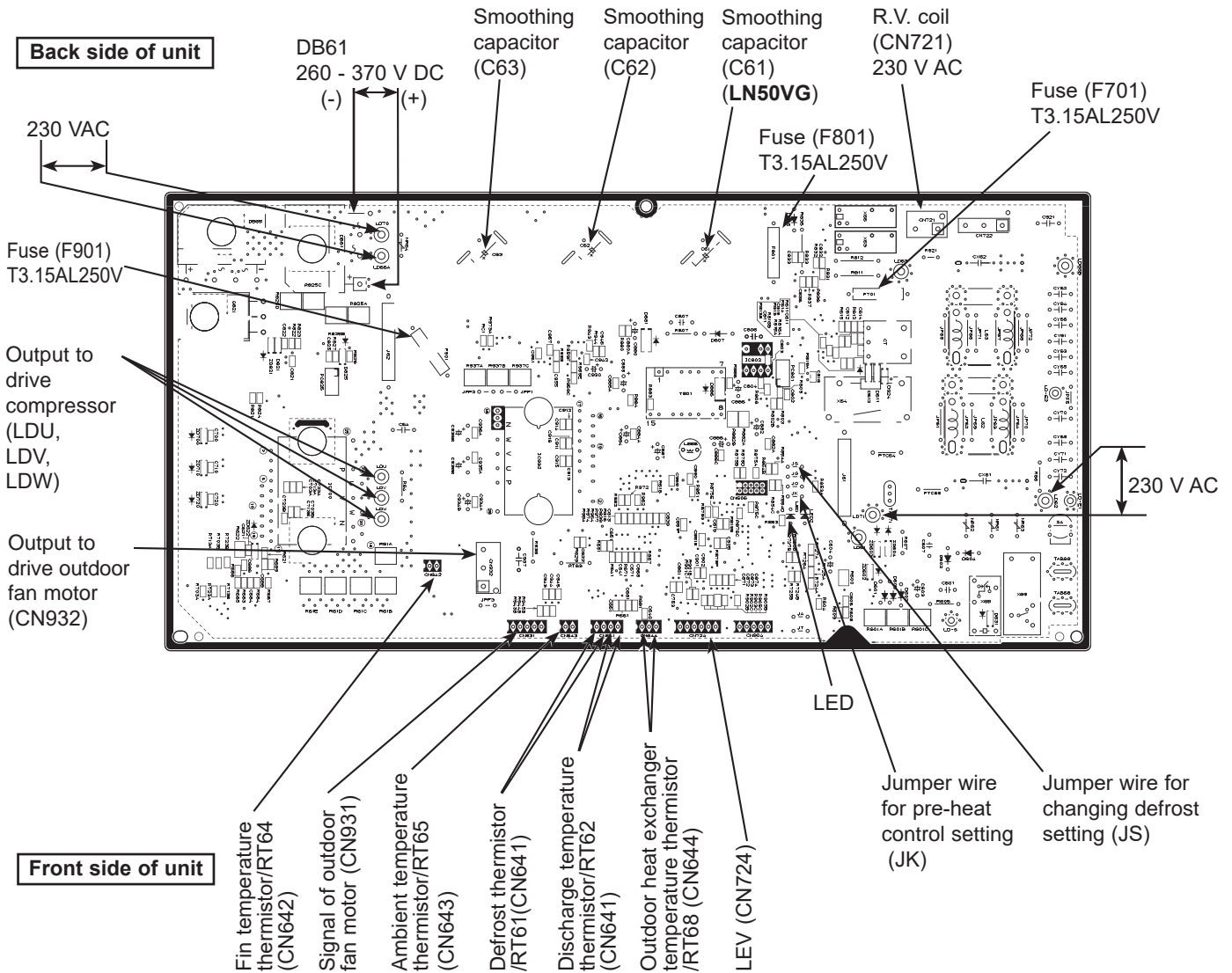

Defrost thermistor(RT61)
Ambient temperature thermistor(RT65)
Outdoor heat exchanger temperature thermistor(RT68)

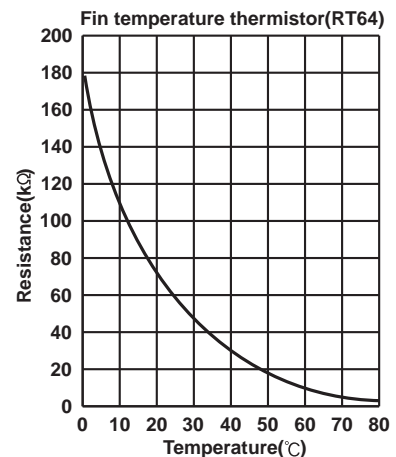
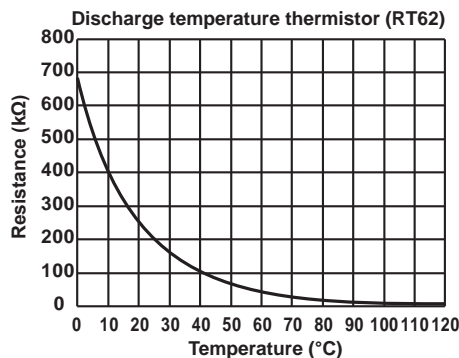
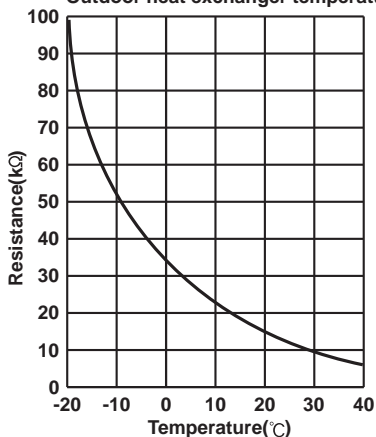

MUZ-LN25VG2

MUZ-LN35VG2

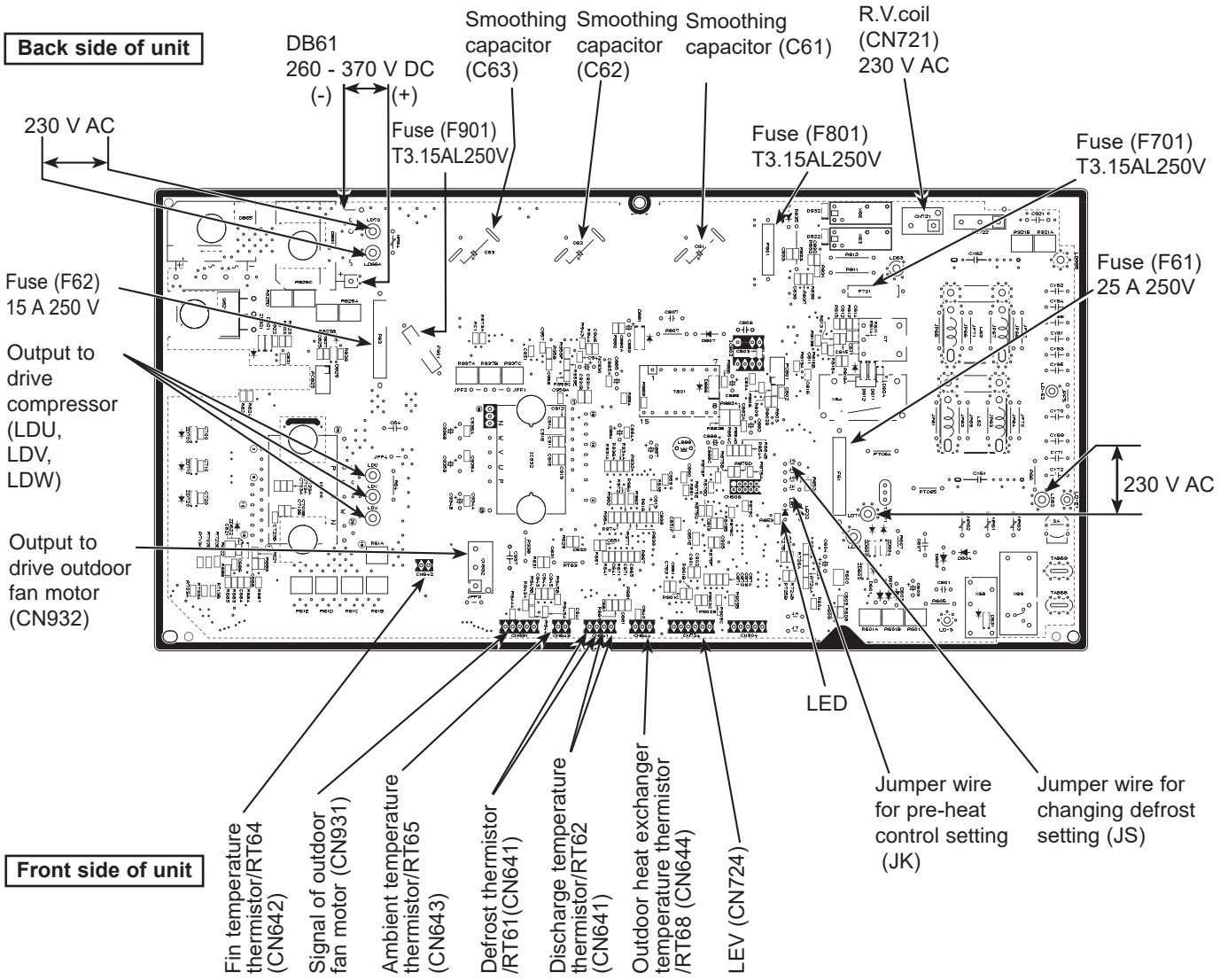

Defrost thermistor(RT61)
Ambient temperature thermistor(RT65)
Outdoor heat exchanger temperature thermistor(RT68)

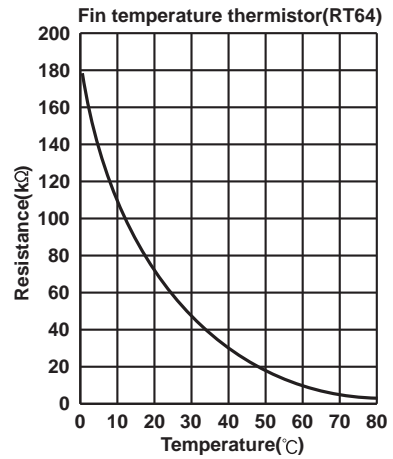
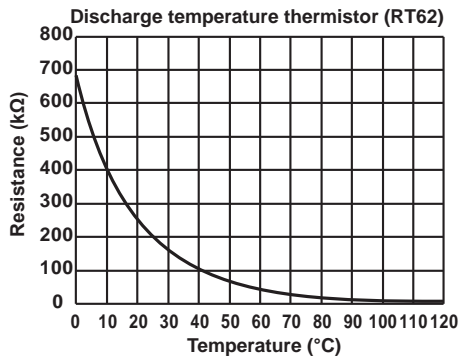
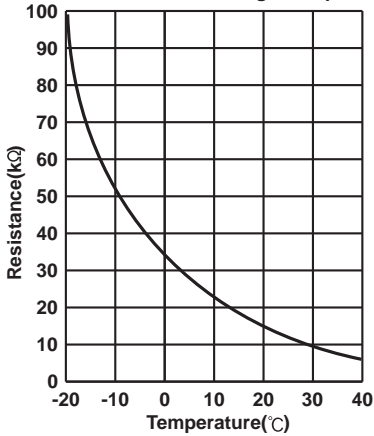

MUZ-LN60VG

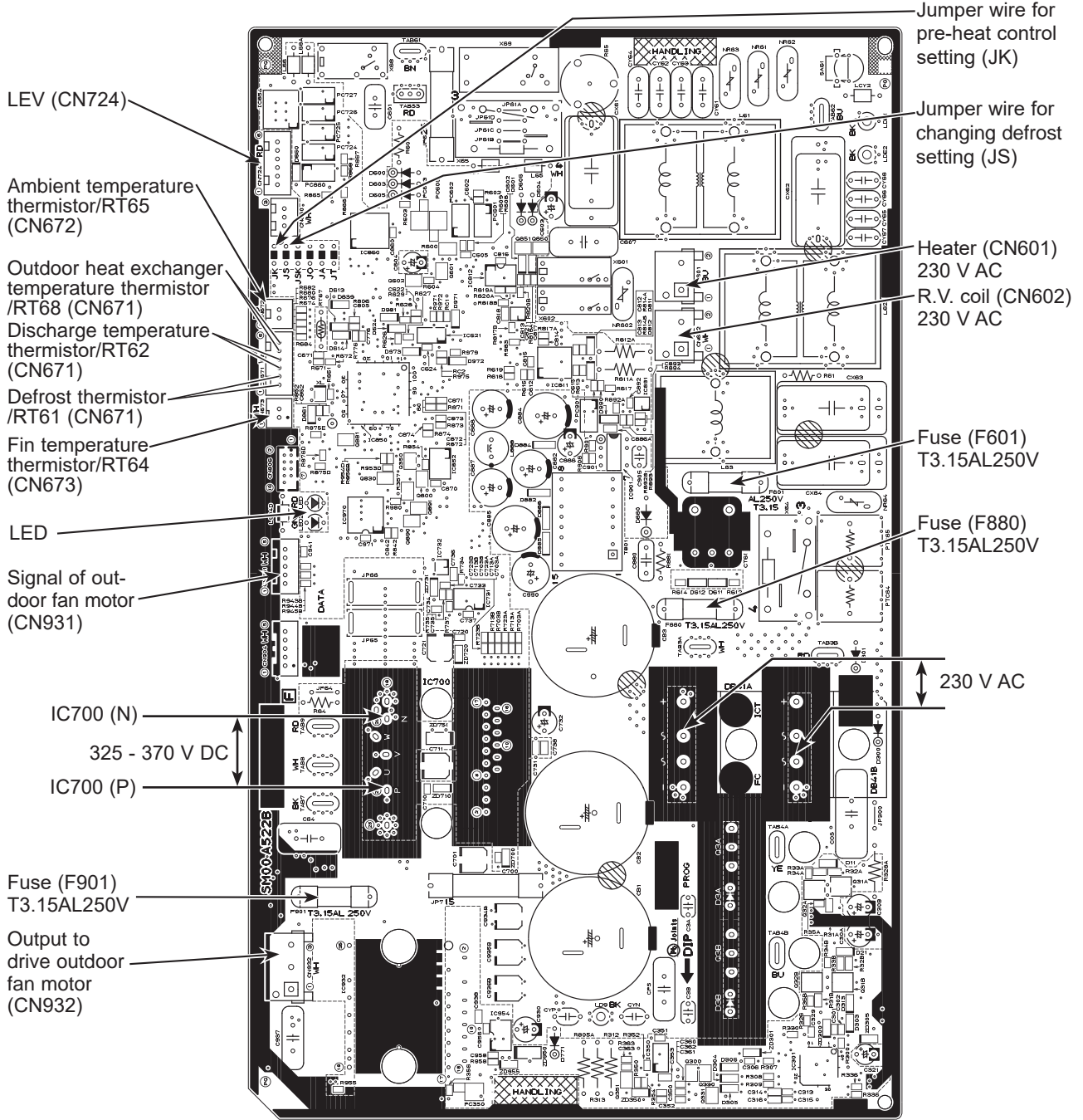

Defrost thermistor(RT61)
Ambient temperature thermistor(RT65)
Outdoor heat exchanger temperature thermistor(RT68)

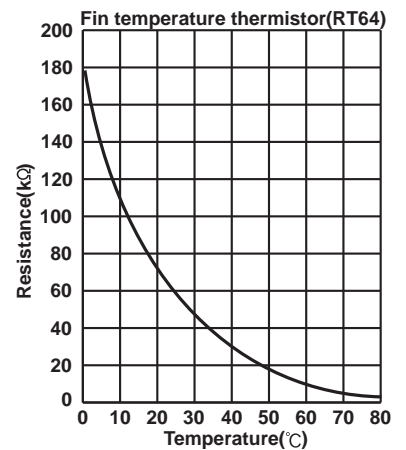
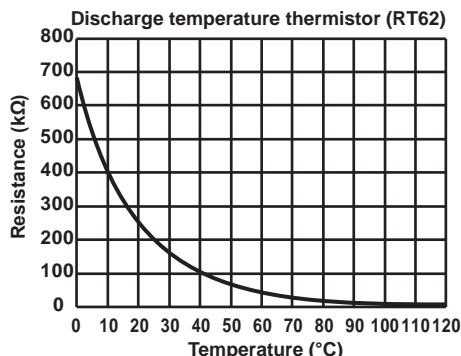
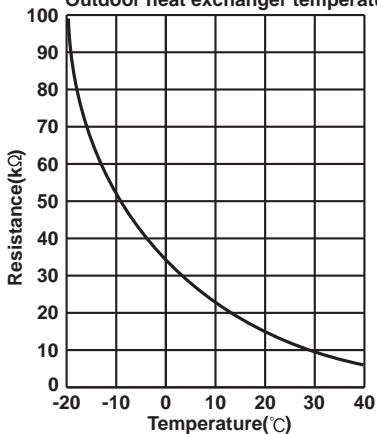

<"Terminal with locking mechanism" Detaching points>

The terminal which has the locking mechanism can be detached as shown below.

There are 2 types (refer to (1) and (2)) of the terminal with locking mechanism.

The terminal without locking mechanism can be detached by pulling it out.

Check the shape of the terminal before detaching.

(1) Slide the sleeve and check if there is a locking lever or not.

(2) The terminal with this connector has the locking mechanism.

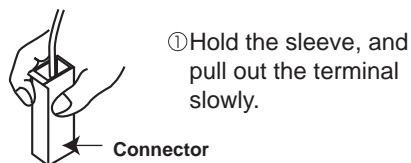
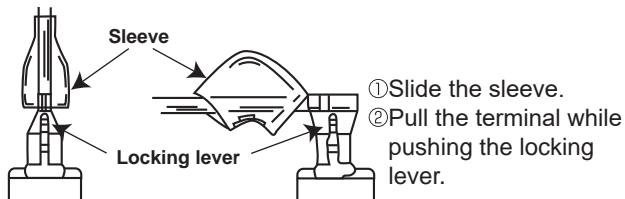

13-1. MUZ-LN25VG MUZ-LN35VG MUZ-LN25VG2 MUZ-LN35VG2

NOTE: Turn OFF the power supply before disassembly.

→ : Indicates the visible parts in the photos.
 ---→ : Indicates the invisible parts in the photos.

OPERATING PROCEDURE	PHOTOS/FIGURES
<p>1. Removing the cabinet</p> <p>(1) Remove the screws fixing the service panel. (2) Pull down the service panel and remove it. (3) Disconnect the power supply cord and indoor/outdoor connecting wire. (4) Remove the screws fixing the top panel. (5) Remove the top panel. (6) Remove the screws fixing the cabinet. (7) Remove the cabinet. (8) Remove the screws fixing the back panel. (9) Remove the screws of the terminal block support and the back panel. (10) Remove the back panel.</p> <p>Photo 2</p>	<p>Photo 1</p> <p>Photo 3</p>

OPERATING PROCEDURE

2. Removing the inverter assembly and inverter P.C. board

- (1) Remove the cabinet and panels (refer to section 1).
- (2) Disconnect the lead wire to the reactor and the following connectors:
<Inverter P.C. board>
CN721 (R.V. coil)
CN931, CN932 (Fan motor)
CN641 (Defrost thermistor and discharge temperature thermistor)
CN643 (Ambient temperature thermistor)
CN644 (Outdoor heat exchanger temperature thermistor)
CN724 (LEV)
- (3) Remove the compressor connector (CN61).
- (4) Remove the screws fixing the heat sink support and the separator.
- (5) Remove the fixing screw of the P.B. support and the separator.
- (6) Remove the fixing screws of the terminal block support and the back panel.
- (7) Remove the inverter assembly.
- (8) Remove the heat sink support from the P.C. board support.
- (9) Remove the screw of the inverter P.C. board and remove the inverter P.C. board from the P.C. board support.

* Connection procedure when attaching the inverter P.C. board (Photo 5)

1. Connect the lead wires of the heat exchanger temperature thermistor to the connector on the inverter P.C. board. Pull the lead wires of the heat exchanger temperature thermistor toward you and put them on the left hook on the P.C. board support so that the other lead wires are bundled up as shown in Photo 5.
2. Connect the lead wires of the expansion valve coil to the connector on the inverter P.C. board. Pull the lead wires of the expansion valve coil toward you and put them on the right hook on the P.C. board support so that the other lead wires are bundled up as shown in Photo 5.

Photo 6 (Inverter assembly)

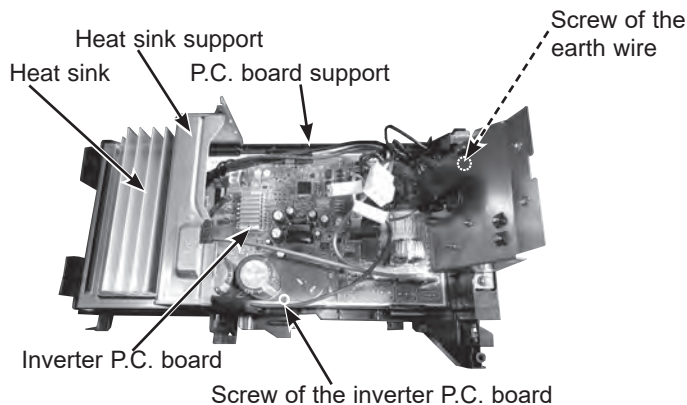

PHOTOS/FIGURES

Photo 4

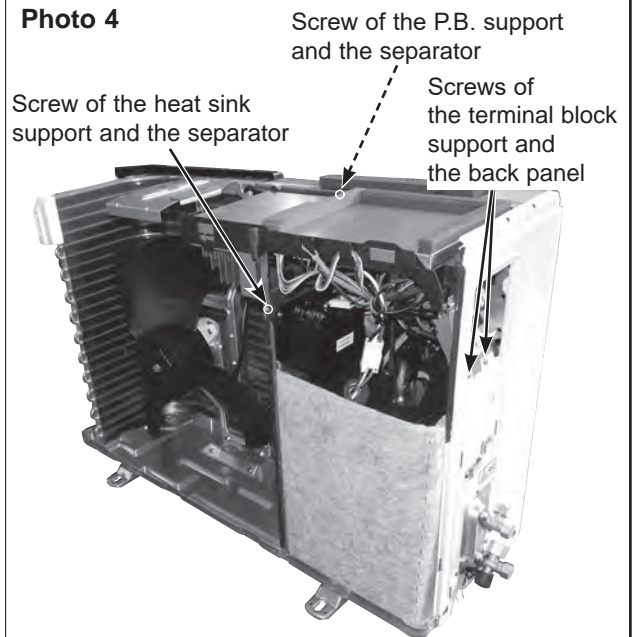
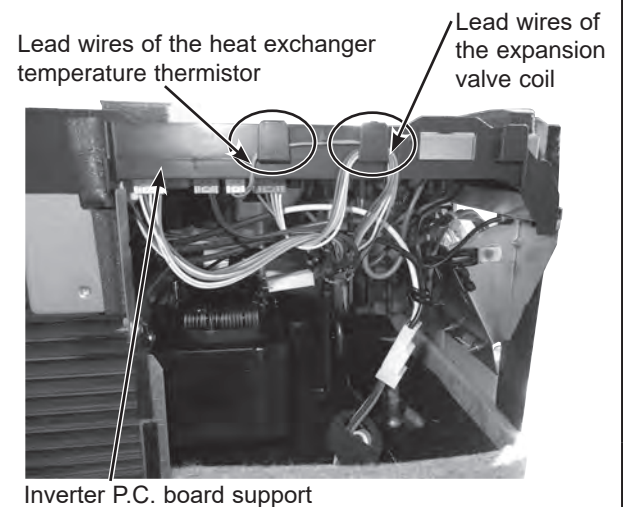

Photo 5



OPERATING PROCEDURE

PHOTOS/FIGURES

3. Removing R. V. coil

- (1) Remove the cabinet and panels (refer to section 1).
- (2) Disconnect the following connectors:
<Inverter P.C. board>
CN721 (R.V. coil)
- (3) Remove the R.V. coil.

Photo 7

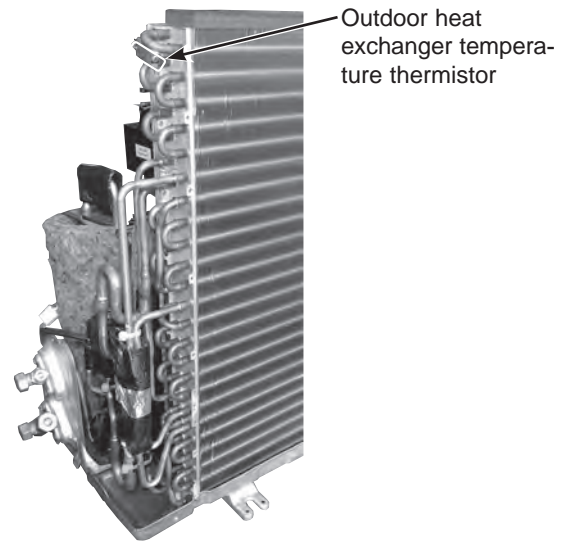

4. Removing the discharge temperature thermistor, defrost thermistor, outdoor heat exchanger temperature thermistor and ambient temperature thermistor

- (1) Remove the cabinet and panels (refer to section 1).
- (2) Disconnect the lead wire to the reactor and the following connectors:
<Inverter P.C. board>
CN641 (Defrost thermistor and discharge temperature thermistor)
CN643 (Ambient temperature thermistor)
CN644 (Outdoor heat exchanger temperature thermistor)
- (3) Pull out the discharge temperature thermistor from its holder.
- (4) Pull out the defrost thermistor from its holder.
- (5) Pull out the outdoor heat exchanger temperature thermistor from its holder.
- (6) Pull out the ambient temperature thermistor from its holder.

Photo 8

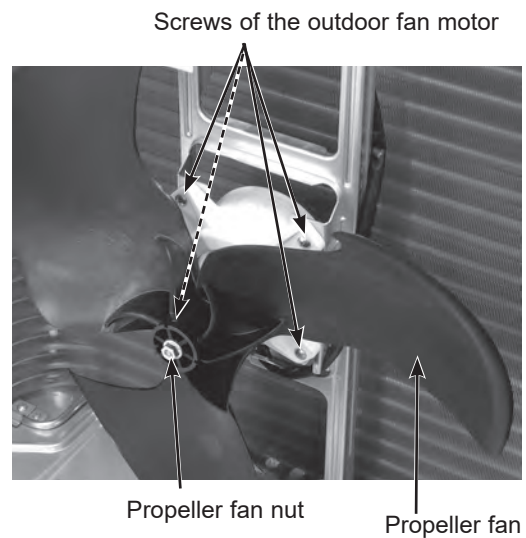

5. Removing outdoor fan motor

- (1) Remove the cabinet and panels (refer to section 1).
- (2) Disconnect the following connectors:
<Inverter P.C. board>
CN931, CN932 (Fan motor)
- (3) Remove the propeller fan nut.
- (4) Remove the propeller fan.
- (5) Remove the screws fixing the fan motor.
- (6) Remove the fan motor.

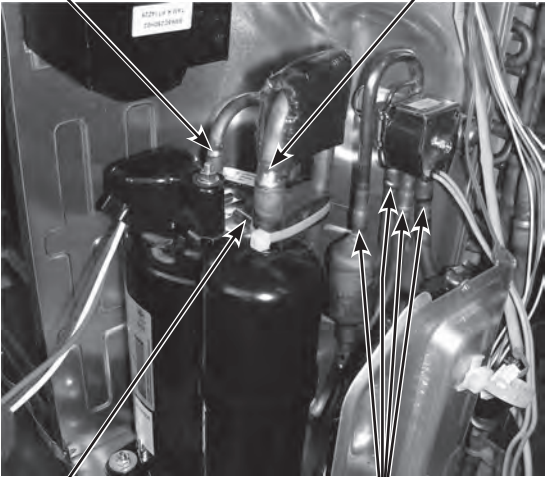

OPERATING PROCEDURE	PHOTOS/FIGURES
<p>6. Removing the compressor and 4-way valve</p> <p>(1) Remove the cabinet and panels (refer to section 1).</p> <p>(2) Remove the inverter assembly (refer to section 2).</p> <p>(3) Recover gas from the refrigerant circuit.</p> <p>NOTE: Recover gas from the pipes until the pressure gauge shows 0 kg/cm² (0 MPa).</p> <p>(4) Detach the brazed part of the suction and the discharge pipe connected with compressor.</p> <p>(5) Remove the compressor nuts.</p> <p>(6) Remove the compressor.</p> <p>(7) Detach the brazed part of pipes connected with 4-way valve.</p>	<p>Photo 9</p> <p>Discharge pipe brazed part</p> <p>Suction pipe brazed part</p>  <p>Discharge temperature thermistor</p> <p>Brazed parts of 4-way valve</p>

13-2. MUZ-LN50VG MUZ-LN50VG2

NOTE: Turn OFF the power supply before disassembly.

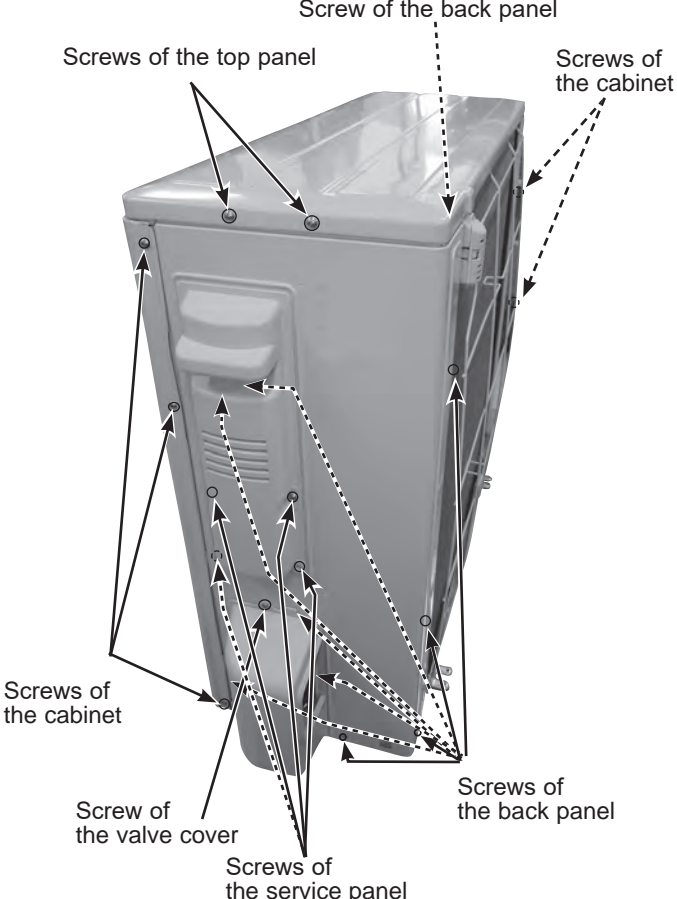
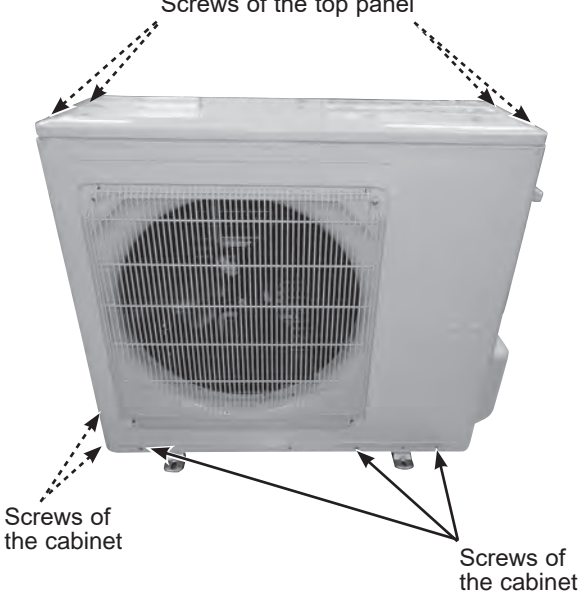
OPERATING PROCEDURE	PHOTOS/FIGURES
<p>1. Removing the cabinet</p> <ol style="list-style-type: none">(1) Remove the screws of the service panel.(2) Remove the screws of the top panel.(3) Remove the screw of the valve cover.(4) Remove the service panel.(5) Remove the top panel.(6) Remove the valve cover.(7) Disconnect the power supply cord and indoor/outdoor connecting wire.(8) Remove the screws of the cabinet.(9) Remove the cabinet.(10) Remove the screws of the back panel.(11) Remove the back panel. <p>Photo 2</p>  <p>Screws of the top panel</p> <p>Screw of the back panel</p> <p>Screws of the cabinet</p> <p>Screw of the valve cover</p> <p>Screws of the service panel</p> <p>Screws of the cabinet</p> <p>Screws of the back panel</p>	<p>Photo 1</p>  <p>Screws of the top panel</p> <p>Screws of the cabinet</p> <p>Screws of the cabinet</p>

OPERATING PROCEDURE

2. Removing the inverter assembly and inverter P.C. board

- (1) Remove the cabinet and panels (refer to section 1).
- (2) Disconnect the lead wire to the reactor and the following connectors:
 - <Inverter P.C. board>
 - CN721 (R.V. coil)
 - CN931, CN932 (Fan motor)
 - CN641 (Defrost thermistor and discharge temperature thermistor)
 - CN643 (Ambient temperature thermistor)
 - CN644 (Outdoor heat exchanger temperature thermistor)
 - CN724 (LEV)
- (3) Remove the compressor connector (CN61).
- (4) Remove the screws fixing the heat sink support and the separator.
- (5) Remove the fixing screw of the P.B. support and the separator.
- (6) Remove the fixing screws of the terminal block support and the back panel.
- (7) Remove the inverter assembly.
- (8) Remove the heat sink support from the P.C. board support.
- (9) Remove the screw of the inverter P.C. board and remove the inverter P.C. board from the P.C. board support.

* Connection procedure when attaching the inverter P.C. board (Photo 4)

1. Connect the lead wires of the heat exchanger temperature thermistor, the defrost thermistor and discharge temperature thermistor to the connector on the inverter P.C. board. Pull the lead wires toward you and put them on the right hook on the P.C. board support.
2. Connect the lead wires of the LEV to the connector on the inverter P.C. board. Pull the lead wires toward you and put them on the right hook on the P.C. board support.
3. Connect the lead wires of the ambient temperature thermistor to the connector on the inverter P.C. board. Pull the lead wires toward you and put them on the left hook on the P.C. board support so that the fan motor lead wires are bundled up as shown in Photo 4.

PHOTOS/FIGURES

Photo 3

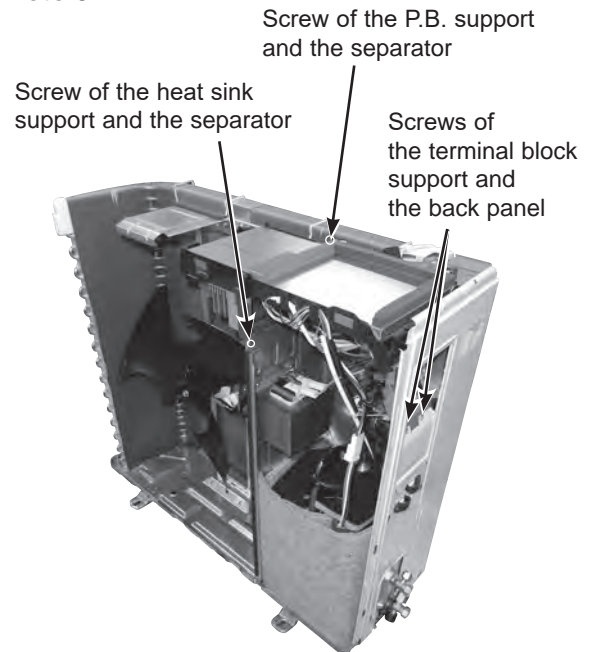
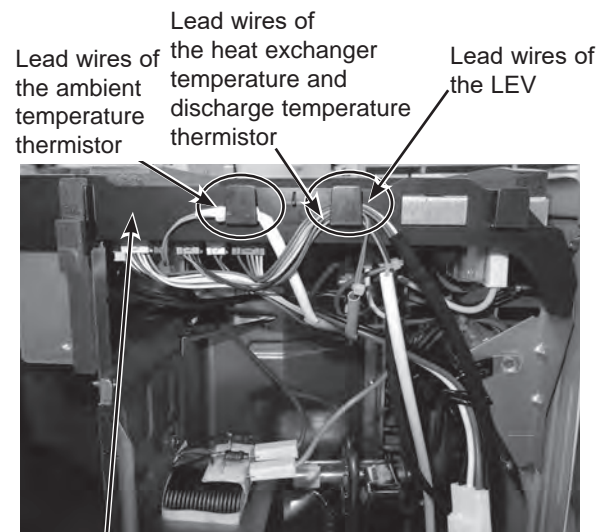
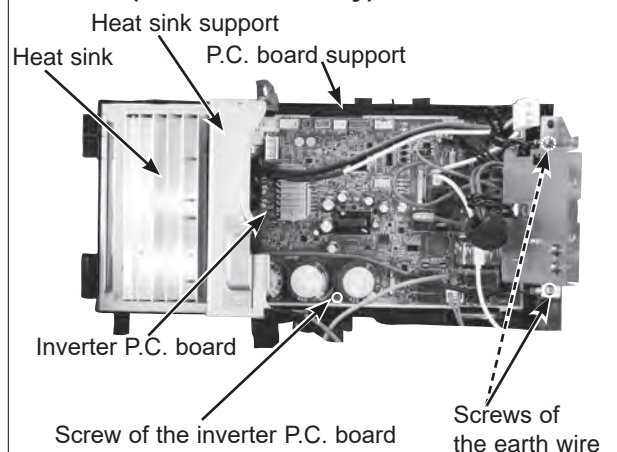

Photo 4



Inverter P.C. board support

Photo 5 (Inverter assembly)



OPERATING PROCEDURE

3. Removing R. V. coil

- (1) Remove the cabinet and panels (refer to section 1).
- (2) Disconnect the following connectors:
<Inverter P.C. board>
CN721 (R.V. coil)
- (3) Remove the R.V. coil.

4. Removing the discharge temperature thermistor, defrost thermistor, outdoor heat exchanger temperature thermistor and ambient temperature thermistor

- (1) Remove the cabinet and panels (refer to section 1).
- (2) Disconnect the lead wire to the reactor and the following connectors:
<Inverter P.C. board>
CN641 (Defrost thermistor and discharge temperature thermistor)
CN643 (Ambient temperature thermistor)
CN644 (Outdoor heat exchanger temperature thermistor)
- (3) Pull out the discharge temperature thermistor from its holder.
- (4) Pull out the defrost thermistor from its holder.
- (5) Pull out the outdoor heat exchanger temperature thermistor from its holder.
- (6) Pull out the ambient temperature thermistor from its holder.

5. Removing outdoor fan motor

- (1) Remove the cabinet and panels (refer to section 1).
- (2) Disconnect the following connectors:
<Inverter P.C. board>
CN931, CN932 (Fan motor)
- (3) Remove the propeller fan nut.
- (4) Remove the propeller fan.
- (5) Remove the screws fixing the fan motor.
- (6) Remove the fan motor.

PHOTOS/FIGURES

Photo 6

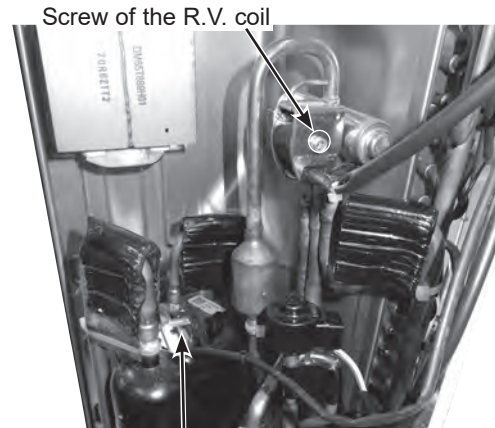

Photo 7

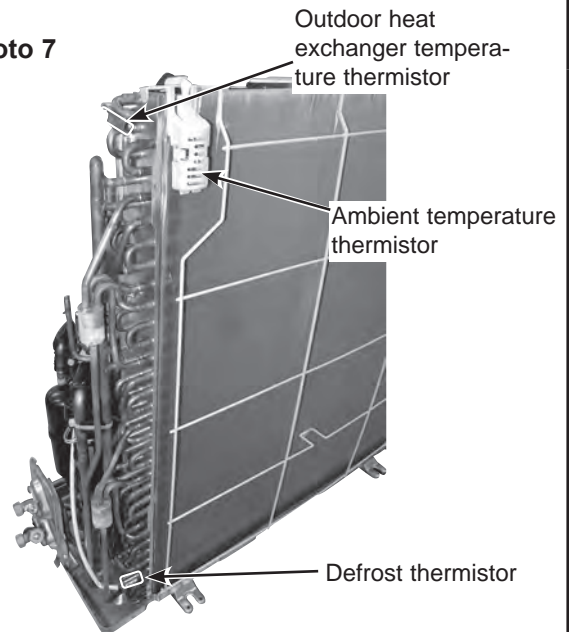
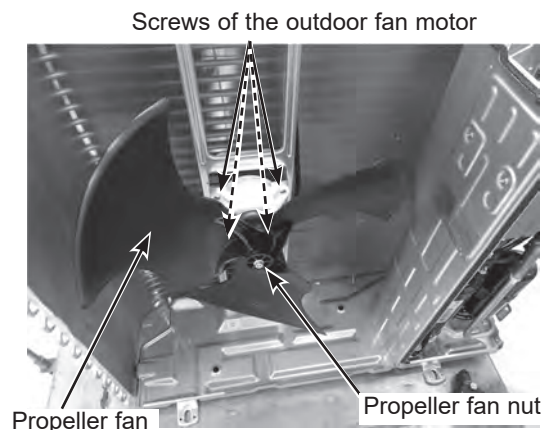

Photo 8





OPERATING PROCEDURE

- 6. Removing the compressor and 4-way valve**
- (1) Remove the cabinet and panels (refer to section 1).
 - (2) Remove the inverter assembly (refer to section 2).
 - (3) Recover gas from the refrigerant circuit.
NOTE: Recover gas from the pipes until the pressure gauge shows 0 kg/cm² (0 MPa).
 - (4) Detach the brazed part of the suction and the discharge pipe connected with compressor.
 - (5) Remove the compressor nuts.
 - (6) Remove the compressor.
 - (7) Detach the brazed part of pipes connected with 4-way valve.

PHOTOS/FIGURES

Photo 9

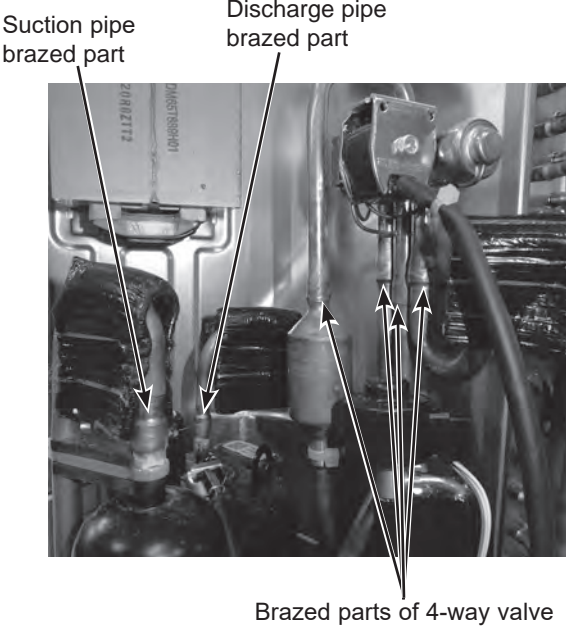

13-3. MUZ-LN60VG

NOTE: Turn OFF the power supply before disassembly.

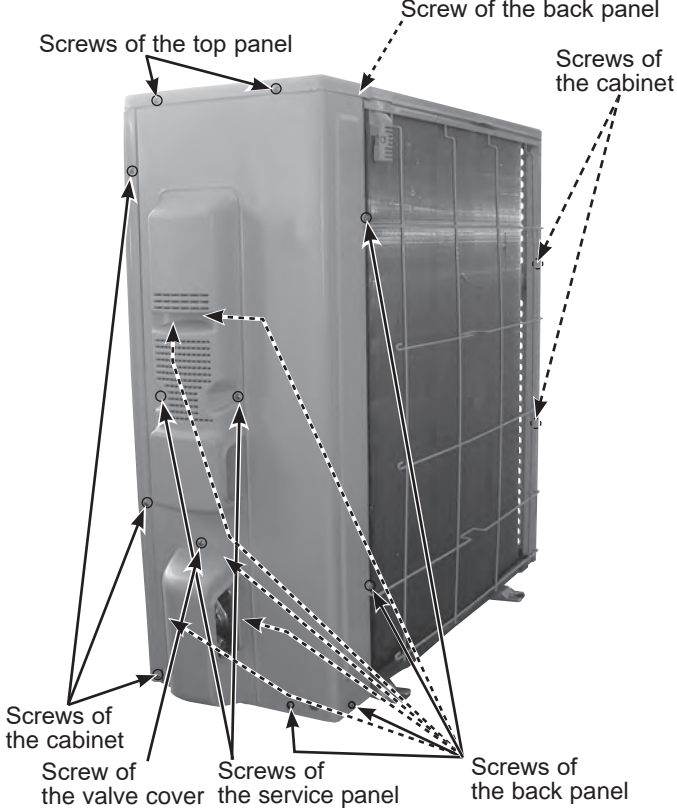
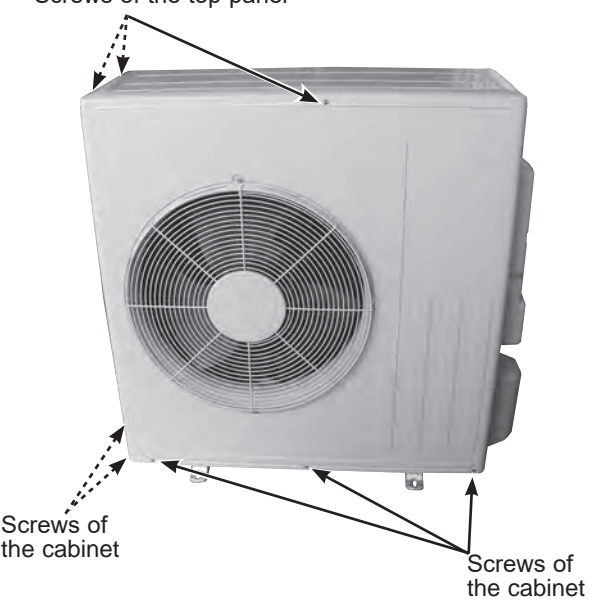
OPERATING PROCEDURE	PHOTOS/FIGURES
<p>1. Removing the cabinet</p> <ol style="list-style-type: none">(1) Remove the screws of the service panel.(2) Remove the screws of the top panel.(3) Remove the screw of the valve cover.(4) Remove the service panel.(5) Remove the top panel.(6) Remove the valve cover.(7) Disconnect the power supply cord and indoor/outdoor connecting wire.(8) Remove the screws of the cabinet.(9) Remove the cabinet.(10) Remove the screws of the back panel.(11) Remove the back panel. <p>Photo 2</p>  <p>Screws of the top panel</p> <p>Screw of the back panel</p> <p>Screws of the cabinet</p> <p>Screws of the cabinet</p> <p>Screws of the cabinet</p> <p>Screw of the valve cover</p> <p>Screws of the service panel</p> <p>Screws of the back panel</p>	<p>Photo 1</p>  <p>Screws of the top panel</p> <p>Screws of the cabinet</p> <p>Screws of the cabinet</p>

OPERATING PROCEDURE

2. Removing the inverter assembly and inverter P.C. board

- (1) Remove the cabinet and the service panel (refer to section 1).
- (2) Disconnect the lead wire to the reactor and the following connectors:
<Inverter P.C. board>
CN602 (R.V. coil)
CN931, CN932 (Fan motor)
CN671 (Defrost thermistor, discharge temperature thermistor and outdoor heat exchanger temperature thermistor)
CN672 (Ambient temperature thermistor)
CN724 (LEV)
- (3) Remove the compressor connector.
- (4) Remove the earth wires and the lead wires of the inverter P.C. board.
- (5) Remove the screws of the P.B. support.
- (6) Remove the P.B. support from the relay panel.
- (7) Remove the screws of the inverter P.C. board.
- (8) Remove the inverter P.C. board from P.B. support.

* Notes about attaching the inverter P.C. board

1. When attaching the inverter P.C. board, clip the lead wires of the reactor to the wire saddles on the bottom of relay panel.
2. After attaching the inverter P.C. board, make sure that the lead wires are connected and placed as shown in Photo 3.

PHOTOS/FIGURES

Photo 3

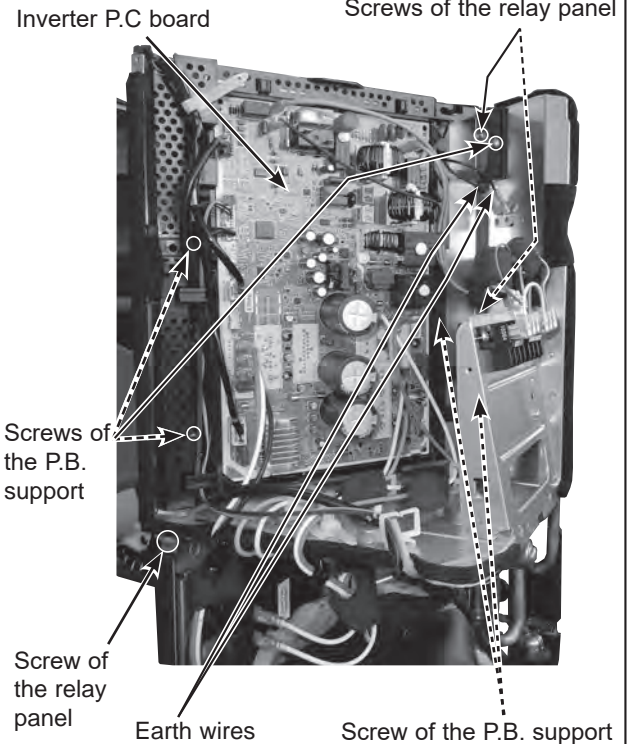
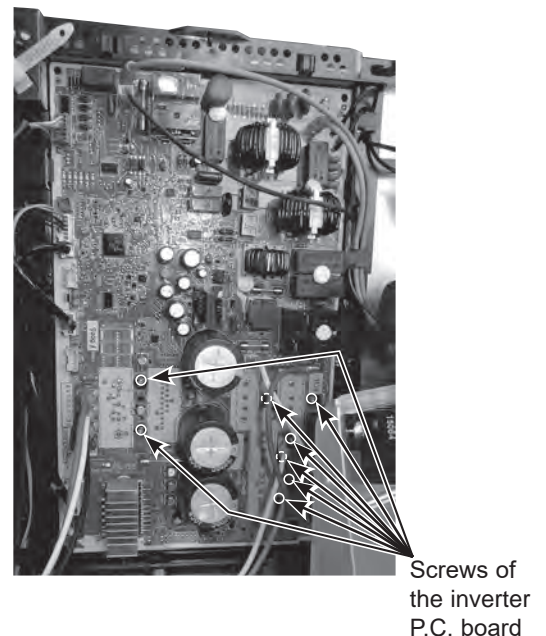

Photo 4



OPERATING PROCEDURE

3. Removing R.V. coil

- (1) Remove the cabinet and panels. (Refer to 1.)
- (2) Disconnect the following connector:
<Inverter P.C. board>
CN602 (R.V. coil)
- (3) Remove the R.V. coil.

PHOTOS/FIGURES

Photo 5

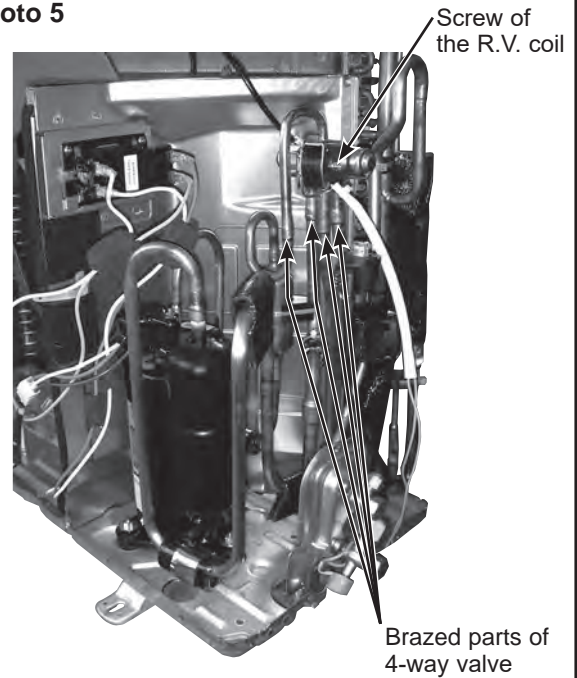

4. Removing the discharge temperature thermistor, defrost thermistor, outdoor heat exchanger temperature thermistor and ambient temperature thermistor

- (1) Remove the cabinet and panels. (Refer to 1.)
- (2) Disconnect the lead wire to the reactor and the following connectors:
<Inverter P.C. board>
CN671 (Defrost thermistor, discharge temperature thermistor and outdoor heat exchanger temperature thermistor)
CN672 (Ambient temperature thermistor)
- (3) Pull out the discharge temperature thermistor from its holder. (Photo 9)
- (4) Pull out the defrost thermistor from its holder.
- (5) Pull out the outdoor heat exchanger temperature thermistor from its holder.
- (6) Pull out the ambient temperature thermistor from its holder.

Photo 6

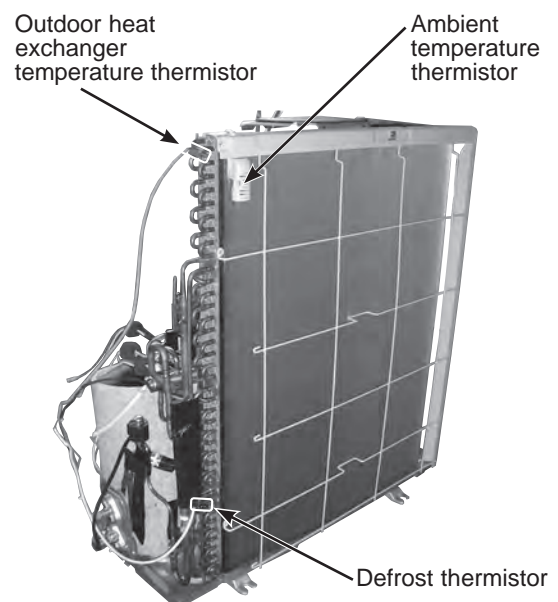



OPERATING PROCEDURE

5. Removing outdoor fan motor

- (1) Remove the top panel, cabinet and service panel (refer to section1).
- (2) Disconnect the following connectors:
<Inverter P.C. board>
CN931, CN932 (Fan motor)
- (3) Remove the propeller fan nut.
- (4) Remove the propeller fan.
- (5) Remove the screws fixing the fan motor.
- (6) Remove the fan motor.

6. Removing the compressor and 4-way valve

- (1) Remove the top panel, cabinet and service panel (refer to section 1).
- (2) Remove the back panel (refer to section 1).
- (3) Remove the screws fixing the relay panel.
- (4) Remove the relay panel.
- (5) Remove the inverter assembly (refer to section 2).
- (6) Recover gas from the refrigerant circuit.
NOTE: Recover gas from the pipes until the pressure gauge shows 0 kg/cm² (0 MPa).
- (7) Detach the brazed part of the suction and the discharge pipe connected with compressor.
- (8) Remove the compressor nuts.
- (9) Remove the compressor.
- (10) Detach the brazed parts of 4-way valve and pipe. (Photo 6)

PHOTOS/FIGURES

Photo 7

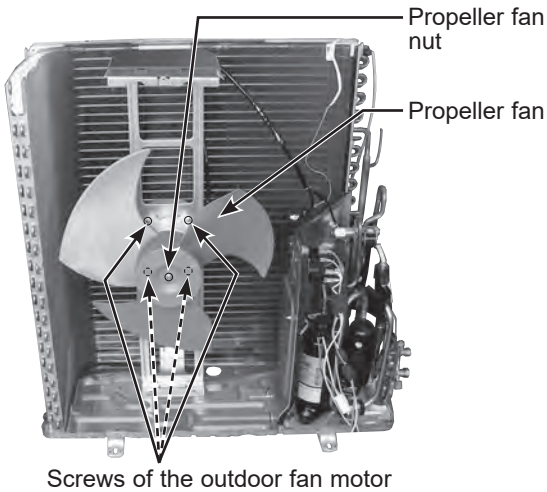
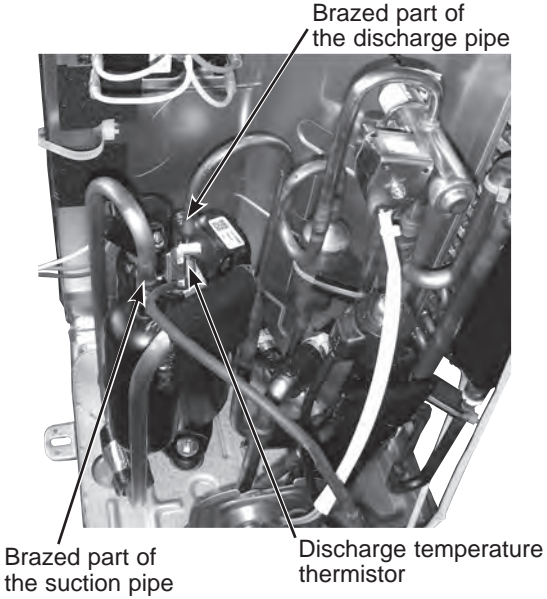

Photo 8





MITSUBISHI ELECTRIC CORPORATION

HEAD OFFICE: TOKYO BUILDING, 2-7-3, MARUNOUCHI, CHIYODA-KU, TOKYO 100-8310, JAPAN

© Copyright 2016 MITSUBISHI ELECTRIC CORPORATION

Issued: Dec. 2019. No. OBH767 REVISED EDITION-B

Issued: Mar. 2018. No. OBH767 REVISED EDITION-A

Published: Dec. 2016. No. OBH767

Made in Japan

Specifications are subject to change without notice.