



SERVICE MANUAL

VRF INVERTER MULTI-SYSTEM AIR-CONDITIONERS (HEAT RECOVERY 3-PIPE SYSTEMS)

(OUTDOOR UNIT)

KXZR series (Heat recovery type)

Standard series

•Single use

FDC224KXZRE1,280KXZRE1,335KXZRE1,400KXZRE1,450KXZRE1,475KXZRE1,500KXZRE1,560KXZRE1,615KXZRE1,670KXZRE1

•Combination use

FDC735KXZRE1,800KXZRE1,850KXZRE1,900KXZRE1,950KXZRE1,1000KXZRE1,1060KXZRE1,1120KXZRE1,1200KXZRE1,1250KXZRE1,1300KXZRE1,1350KXZRE1,1425KXZRE1,1450KXZRE1,1500KXZRE1,1560KXZRE1,1620KXZRE1,1680KXZRE1

•High-COP combination use

FDC450KXZRXE1(FDC224KXZRE1+FDC224KXZRE1),
 FDC500KXZRXE1(FDC224KXZRE1+FDC280KXZRE1),
 FDC560KXZRXE1(FDC280,KXZRE1+FDC280KXZRE1),
 FDC615KXZRXE1(FDC280KXZRE1+FDC335KXZRE1),
 FDC670KXZRXE1(FDC335KXZRE1+FDC335KXZRE1),
 FDC735KXZRXE1(FDC224KXZRE1+FDC224KXZRE1+FDC280KXZRE1),
 FDC800KXZRXE1(FDC224KXZRE1+FDC280KXZRE1+FDC280KXZRE1),
 FDC850KXZRXE1(FDC280KXZRE1+FDC280KXZRE1+FDC280KXZRE1),
 FDC900KXZRXE1(FDC280KXZRE1+FDC280KXZRE1+FDC335KXZRE1),
 FDC950KXZRXE1(FDC280KXZRE1+FDC335KXZRE1+FDC335KXZRE1),
 FDC1000KXZRXE1(FDC335KXZRE1+FDC335KXZRE1+FDC335KXZRE1)

• Note:

- (1) Regarding the Indoor unit series, refer to the No.'15 • KX-T-247
- (2) Regarding the Duct Connected-High static Pressure-type Outdoor Air Processing Unit Series (FDU500~1800FKXE6), refer to the DATA BOOK No.'08 • KX-DB-122

CONTENTS

1. OUTLINE OF OPERATION CONTROL BY MICROCOMPUTER	1
1.1 Remote control (Option parts)	1
1.2 Operation control function by the wired remote control	4
1.3 Operation control function by the indoor control	9
1.4 Operation control function by the outdoor control	25
2. SYSTEM TROUBLESHOOTING PROCEDURE	69
2.1 Basics of troubleshooting	69
2.2 Explanation of troubleshooting	70
2.3 Contents of troubleshooting	71
2.4 Outdoor unit control PCB replacement procedure	130
2.5 Outdoor unit inverter PCB replacement procedure	132
2.6 Outdoor unit transistor module replacement procedure	134
2.7 Outdoor unit diode module replacement procedure	135
3. ELECTRICAL WIRING	139
4. PIPING SYSTEM	144
5. APPLICATION DATA	147
5.1 Installation of outdoor unit	147
5.2 Instructions for installing the branch pipe set	171
5.3 Branching control installation guide	175
5.4 Procedure to attach or remove the front panel	179
5.5 Installation work check sheet	180

1. OUTLINE OF OPERATION CONTROL BY MICROCOMPUTER

1.1 Remote control (Option parts)

- (1) Wired remote control
Model RC-EX3

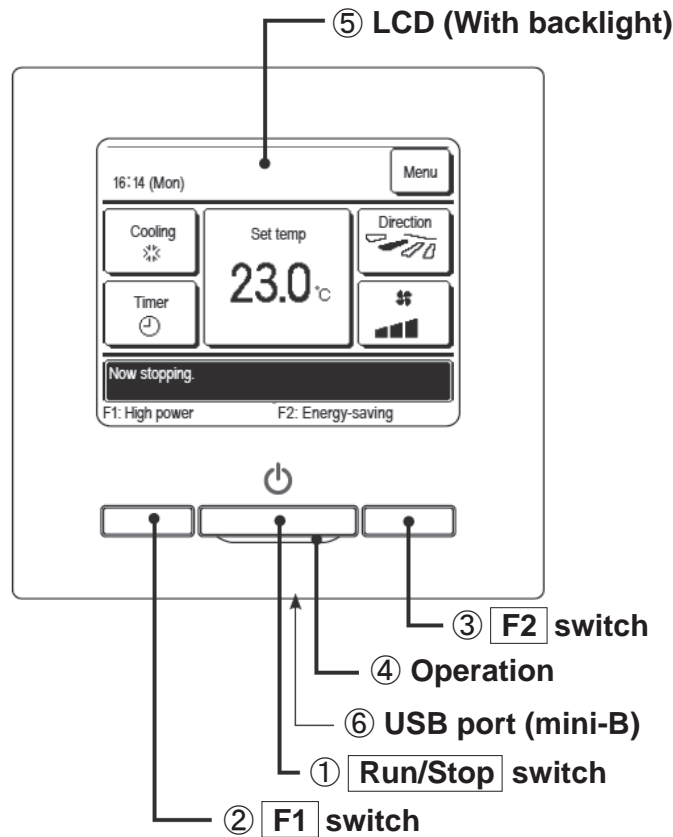

Touch panel system, which is operated by tapping the LCD screen with a finger, is employed for any operations other than the ①Run/Stop, ②F1 and ③F2 switches.

① Run/Stop switch

One push on the button starts operation and another push stops operation.

If the backlight is ON setting, when the screen is tapped while the backlight is turned off, the backlight only is turned on. (Operations with switches ①, ② and ③ are excluded.)

② F1 switch ③ F2 switch

This switch starts operation that is set in switch function change.

⑥ USB port

USB connector (mini-B) allows connecting to a personal computer. For operating methods, refer to the instruction manual attached to the software for personal computer (eco-touch remote control utility software).

④ Operation

This lamp lights in green (yellow-green) during operation. It changes to red (orange) if any error occurs. Operation lamp luminance can be changed.

Note(1) When connecting to a personal computer, do not connect simultaneously with other USB devices. Please be sure to connect to the computer directly, without going through a hub, etc.

⑤ LCD (With backlight)

A tap on the LCD lights the backlight. The backlight turns off automatically if there is no operation for certain period of time. Lighting period of the backlight lighting can be changed.

Model RC-E5

The figure below shows the remote control with the cover opened. Note that all the items that may be displayed in the liquid crystal display area are shown in the figure for the sake of explanation.

Characters displayed with dots in the liquid crystal display area are abbreviated.

The figure below shows the remote control with the cover opened.

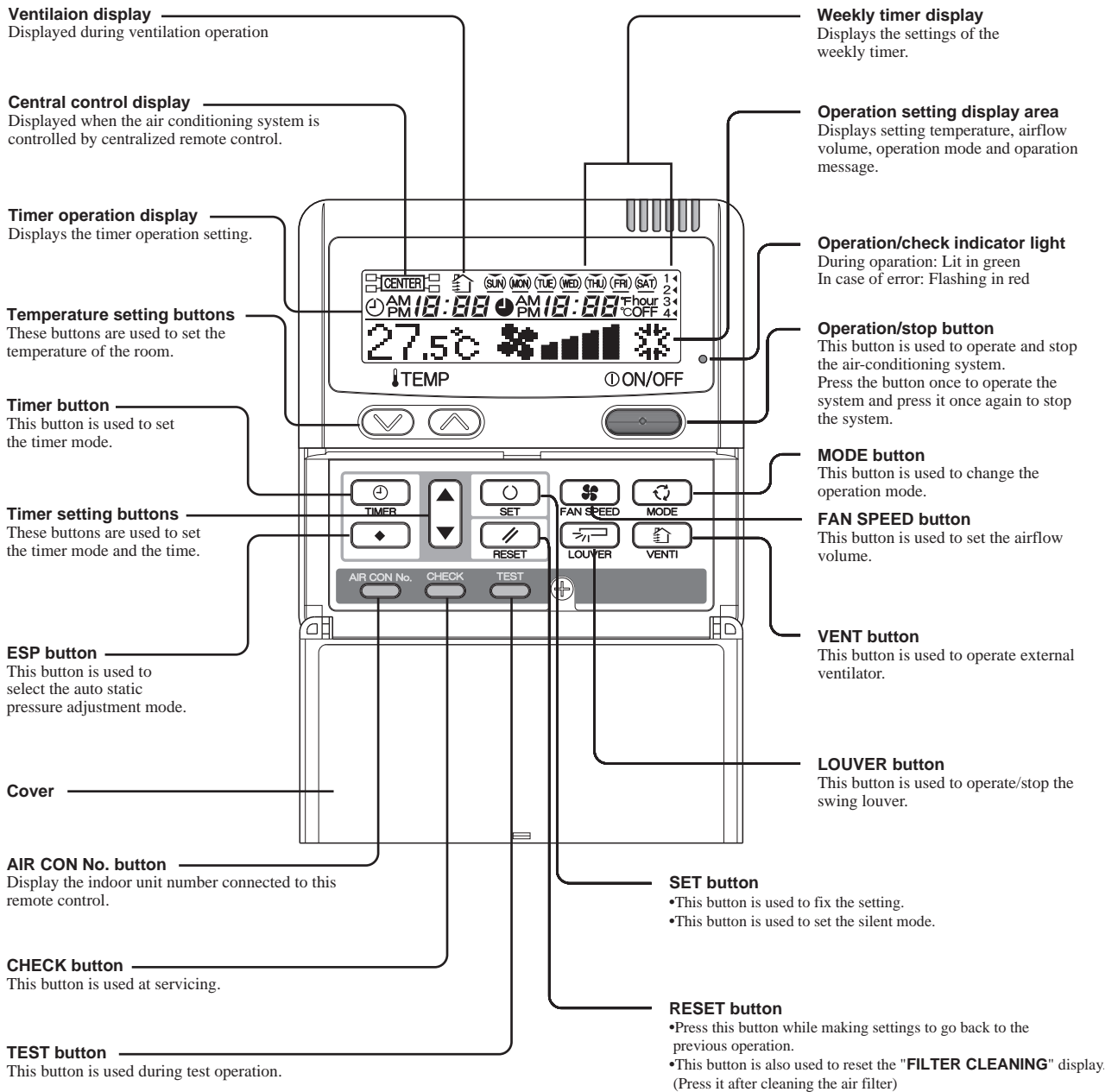

* All displays are described in the liquid crystal display for explanation.

(2) **Wireless remote control**

Indication section

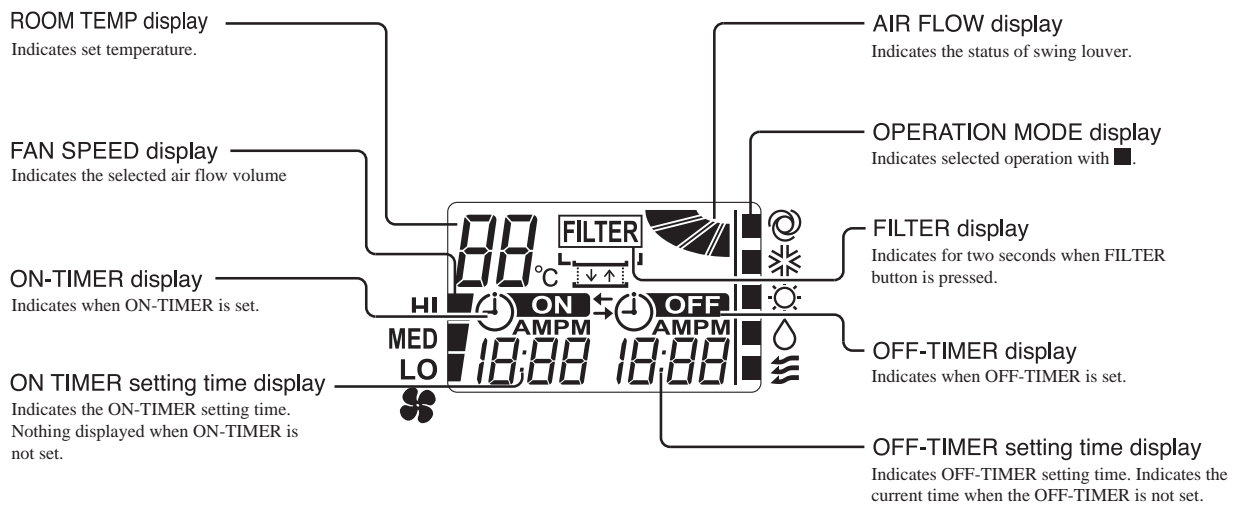

Operation section

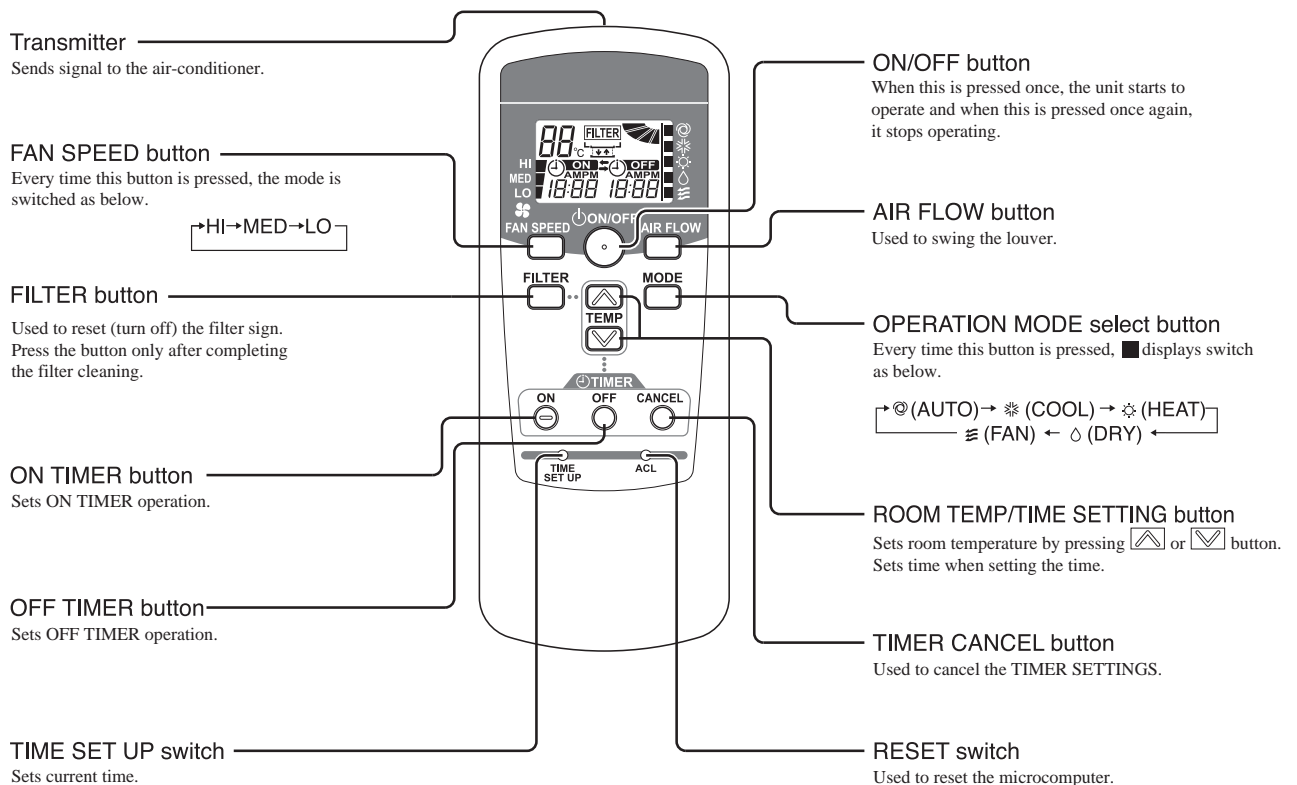

* All displays are described in the liquid crystal display for explanation

1.2 Operation control function by the wired remote control

●Model RC-EX3

(1) Switching sequence of the operation mode switches of remote control

- Tap the change operation mode button on the TOP screen.
- When the change operation mode screen is displayed, tap the button of desired mode.
- When the operation mode is selected, the display returns to the TOP screen.

Icons displayed have the following meanings.

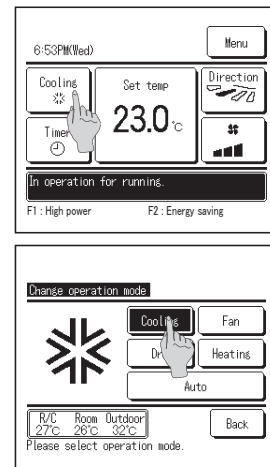
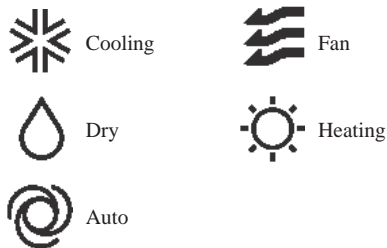

Notes(1) Operation modes which cannot be selected depending on combinations of indoor unit and outdoor unit are not displayed.

- When the Auto is selected, the cooling and heating switching operation is performed automatically according to indoor and outdoor temperatures.

(2) CPU reset

Reset CPU from the remote control as follows.

TOP screen ⇒ ⇒ ⇒

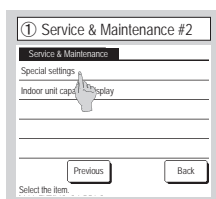

The selected screen is displayed.

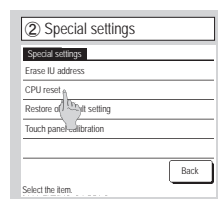

The selected screen is displayed.

Microcomputers of indoor unit and outdoor unit connected are reset (State of restoration after power failure).

(3) Power failure compensation function (Electric power source failure)

Enable the Auto-restart function from the remote control as follows.

TOP screen ⇒ ⇒ ⇒

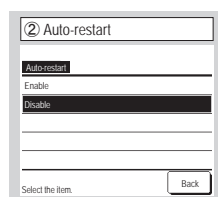
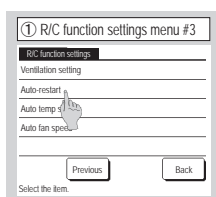

If the unit stops during operation,

It returns to the state before the power failure as soon as the power source is restored (After the end of the primary control at the power on).

It stops after the restoration of power source.

- Since the status of remote control is retained in memory always, it restarts operations according to the contents of memory as soon as the power source is restored. Although the timer mode is cancelled, the weekly timer, peak cut timer and silent mode timer operate according to the following contents:

- When the clock setting is valid : These timer settings are also valid.
- When the clock setting is invalid : These timer settings become "Invalid" since the clock setting is invalid.

These timer settings have to be changed to "Valid" after the timer setting.

●Content memorized with the power failure compensation are as follows.

Note(1) Items (f) and (g) are memorized regardless whether the power failure compensation is effective or not while the setting of silent mode is cancelled regardless whether the power failure compensation is effective or not.

(a) At power failure – Operating/stopped

If it had been operating under the off timer mode, sleep timer mode, the state of stop is memorized.

(b) Operation mode

(c) Air flow volume mode

(d) Room temperature setting

(e) Louver auto swing/stop

However, the stop position (4-position) is cancelled so that it returns to Position (1).

(f) “Remote control function items” which have been set with the administrator or installation function settings (“Indoor function items” are saved in the memory of indoor unit.)

(g) Weekly timer, peak-cut timer or silent mode timer settings

(h) Remote control function setting

(4) Alert displays

If the following (a) to (c) appear, check and repair as follows.

(a) Communication check between indoor unit and remote control



- This appears if communications cannot be established between the remote control and the indoor unit.
Check whether the system is correctly connected (indoor unit, outdoor unit, remote control) and whether the power source for the outdoor unit is connected.

(b) Clock setting check

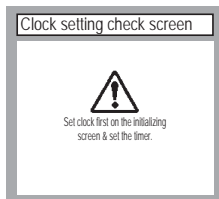

- This appears when the timer settings are done without clock setting.
Set the clock setting before the timer settings.

(c) Misconnection

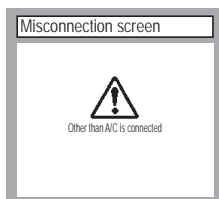

- This appears when something other than the air-conditioner has been connected to the remote control.
Check the location to which the remote control is connected.

(5) Operation and setting from remote control

A : Refer to the instruction manual for RC-EX series
 B : Refer to the installation manual for RC-EX series
 C : Loading a utility software via Internet

○ : Nearly same function setting and operations are possible.
 △ : Similar function setting and operations are possible.

Setting & display item	Description	RC-EX3	RC-E5	
1.Remote control network				
1 Control plural indoor units by a single remote control	A remote control can control plural indoor units up to 16 (in one group of remote control network). An address is set to each indoor unit.		○	
2 Main/sub setting of remote controls	A pair of remote controls (including optional wireless remote control) can be connected within the remote control network. Set one to "Main" and the other to "Sub".	B	○	
2.TOP screen, Switch manipulation				
1 Menu	"Control", "State", or "Details" can be selected. (3-8)	A		
2 Operation mode	"Cooling", "Heating", "Fan", "Dry" or "Auto" can be set.	A	○	
3 Set temp.	"Set temperature" can be set by 0.5°C interval.	A	○	
4 Air flow direction	"Air flow direction" (Individual flap control) can be set. Select Enable or Disable for the "3D AUTO" (in case of FDK).	A	△	
5 Fan speed	"Fan speed" can be set.	A	○	
6 Timer setting	"Timer operation" can be set.	A	○	
7 ON/OFF	"On/Off operation of the system" can be done.	A	○	
8 F1 SW	The system operates and is controlled according to the function specified to the F1 switch.	A		
9 F2 SW	The system operates and is controlled according to the function specified to the F2 switch.	A		
3.Useful functions				
1 Individual flap control	The moving range (the positions of upper limit and lower limit) of the flap for individual flap can be set. Set also the left and right limit positions for FDK.	A	△	
2 Anti draft setting	When the panel with the anti-draft function is assembled, select to Enable or Disable the anti draft setting for each operation mode and for each blow outlet.	A		
3 Timer settings	Set On timer by hour	The period of time to start operation after stopping can be set. • The period of set time can be set within range of 1hour-12hours (1hr interval). • The operation mode, set temp. and fan speed at starting operation can be set.	A	△
	Set Off timer by hour	The period of time to stop operation after starting can be set. • The period of set time can be set within range of 1hour-12hours (1hr interval).	A	△
	Set On timer by clock	The clock time to start operation can be set. • The set clock time can be set by 5 minutes interval. • [Once (one time only)] or [Everyday] operation can be switched. • The operation mode, set temp and fan speed at starting operation can be set.	A	△
	Set Off timer by clock	The clock time to stop operation can be set. • The set clock time can be set by 5 minutes interval. • [Once (one time only)] or [Everyday] operation can be switched.	A	△
Confirmation of timer settings	Status of timer settings can be seen.	A		
4 Favorite setting	Set the operation mode, setting temperature, air flow capacity and air flow direction for the choice setting operations. Set them for the Favorite set 1 and the Favorite set 2 respectively.	A		
5 Weekly timer	On timer and Off timer on weekly basis can be set. • 8-operation patterns per day can be set at a maximum. • The setting clock time can be set by 5 minutes interval. • Holiday setting is available. • The operation mode, set temp and fan speed at starting operation can be set.	A	△	
6 Home leave mode	When leaving home for a long period like a vacation leave, the unit can be operated to maintain the room temperature not to be hotter in summer or not to be colder in winter. • The judgment to switch the operation mode (Cooling ↔ Heating) is done by the both factors of the set temp. and outdoor air temp. • The set temp. and fan speed can be set.	A		
7 External Ventilation	On/Off operation of the external ventilator can be done. It is necessary to set from [Menu] ⇒ [Service setting] ⇒ [R/C function settings] ⇒ [Ventilation setting]. • If the "Independent" is selected for the ventilation setting, the ventilator can be operated or stopped.	A	○	
8 Select the language	Select the language to display on the remote control. • Select from English, German, French, Spanish, Italian, Dutch, Turkish, Portuguese, Russian, Polish, Japanese and Chinese.	A		
4.Energy-saving setting				
Administrator password				
1 Sleep timer	To prevent the timer from keeping ON, set hours to stop operation automatically with this timer. • The selectable range of setting time is from 30 to 240 minutes. (10 minutes interval) • When setting is "Enable", this timer will activate whenever the ON timer is set.	A	△	
2 Peak-cut timer	Power consumption can be reduced by restructuring the maximum capacity. Set the [Start time], the [End time] and the capacity limit % (Peak-cut %). • 4-operation patterns per day can be set at maximum. • The setting time can be changed by 5-minutes interval. • The selectable range of capacity limit % (Peak-cut %) is from 0% to 40-80% (20% interval) • Holiday setting is available.	A		
3 Automatic temp. set back	After the elapse of the set time period, the current set temp. will be set back to the [Set back time]. • The setting can be done in cooling and heating mode respectively. • Selectable range of the set time is from 20 min. to 120 min. (10 min. interval). • Set the [Set back temp.] by 1°C interval.	A	△	
4 Infrared sensor control (Motion sensor control)	When the infrared sensor (motion sensor) is used, it is necessary to set Enable or Disable for the "Power control" and the "Auto-off".	A		
5.Filter				
1 Filter sign reset	Filter sign reset	The filter sign can be reset.	A	
	Setting next cleaning date	The next cleaning date can be set.	A	
6.User setting				
1 Internal settings	Clock setting	The current date and time can be set or revised. • If a power failure continues no longer than 80 hours, the clock continues to tick by the built-in power source.	A	△
	Date and time display	[Display] or [Hide] the date and/or time can be set, and [12H] or [24H] display can be set.	A	
	Summer time	When select [Enable], the +1hour adjustment of current time can be set. When select [Disable], the [Summer time] adjustment can be reset.	A	
	Contrast	The contrast of LCD can be adjusted higher or lower.	A	
	Backlight	Switching on/off a light can be set and period of the lighting time can be set within the range of 5sec-90 sec (5sec interval).	A	
	Control sound	It can set with or without [Control sound (beep sound)] at touch panel.	A	
2 Administrator settings	Operation lamp luminance	This is used to adjust the luminance of operation lamp.	A	
	Permission/Prohibition setting	• Permission/Prohibition setting of operation can be set. [On/Off] [Change set temp] [Change operation mode] [Change flap direction] [Change fan speed] [High power operation] [Energy-saving operation] [Timer] Request for administrator can be set. [Individual flap control] [Weekly timer] [Select the language] [Anti draft setting]	A	△
	Outdoor unit silent mode timer	The period of time to operate the outdoor unit by prioritizing the quietness can be set. • The [Start time] and the [End time] for operating outdoor unit in silent mode can be set. • The period of the operation time can be set once a day by 5 minutes interval.	A	△
	Setting temp. range	The upper/lower limit of temp. setting range can be set. • The limitation of indoor temp. setting range can be set for each operation mode in cooling and heating.	A	△
	Temp increment setting	The temp increment setting can be changed by 0.5°C or 1.0°C.	A	
Set temp. display	Ways of displaying setting temperatures can be selected.	A		

Setting & display item		Description	RC-EX3	RC-E5
2 Administrator settings [Administrator password]	R/C display setting	Register [Room name] [Name of I/U] Display [Indoor temp. display] or not. Display [Error code display] or not. Display [Heating stand-by display] [Defrost operation display] [Auto cooling/heating display] [Display temp of R/C, Room, Outdoor] or not	A	△
	Change administrator password	The administrator password can be changed. (Default setting is "0000") The administrator password can be reset.	A B	
	F1/F2 function setting	Functions can be set for F1 and F2. Selectable functions: [High power operation], [Energy-saving operation], [Silent mode cont.], [Home leave mode], [Favorite set 1], [Favorite set 2] and [Filter sign reset].	A	
7. Service setting				
1 Installer settings [Service password]	Installation date	The [Installation date] can be registered. • When registering the [Installation date], the [Next service date] is displayed automatically. (For changing the [Next service date], please refer the item of [Service & Maintenance])	B	
	Company information	The [Company information] can be registered and can be displayed on the R/C. • The [Company] can be registered within 26 characters. • The [Phone No.] can be registered within 13 digits.	B	
	Test run	On/Off operation of the test run can be done.		
	Cooling test run	The [Cooling test run] can be done at 5°C of set temp. for 30 minutes.	B	○
	Drain pump test run	Only drain pump can be operated.		
	Static pressure adjustment	In case of combination with only the ducted indoor unit which has a function of static pressure adjustment, the static pressure is adjustable. • It can be set for each indoor unit individually.	B	
	Change auto-address	The set address of each indoor unit decided by auto-address setting method can be changed to any other address. (For multiple KX units only)	B	△
	Address setting of main IU	Main indoor unit address can be set. • Only the Main indoor unit can change operation mode and the Sub indoor units dominated by the Main indoor shall follow. • The Main indoor unit can domain 10 indoor units at a maximum.	B	△
IU back-up function	When a pair of indoor units (2 groups) is connected to one unit of remote control, it can be set Enable or Disable for the [IU rotation], [IU capacity back-up] and [IU fault back-up]	B		
Infrared sensor setting (Motion sensor setting) When the panel with the infrared sensor (motion sensor) is assembled.	Set Enable or Disable for the infrared sensor detectors of indoor units connected to the remote control. If Disable is selected, it cannot be control the infrared sensor control for the energy-saving setting.	B		
2 R/C function setting [Service password]	Main/Sub R/C	The R/C setting of [Main/Sub] can be changed.	B	○
	Return air temp.	When two or more indoor units are connected to one unit of remote control, suction sensors, which are used for the judgement by thermostat, can be selected. • It can be selected from [Individual], [Master IU] and [Average temp].	B	
	R/C sensor	It can be set the mode to switch to the remote control sensor. It can be selected from cooling and heating.	B	△
	R/C sensor adjustment	The offset value of [R/C sensor] sensing temp. can be set respectively in heating and cooling.	B	△
	Operation mode °C / °F	Enable or Disable can be set for each operation mode. Set the unit for setting temperatures. • °C or °F can be selected.	B	△
	Fan speed	Fan speeds can be selected.	B	○
	External input	When two or more indoor units are connected to one unit of remote control, the range to apply CnT inputs can be set.	B	○
	Upper/lower flap control	[Stop at fixed position] or [Stop at any position] can be selected for the upper and lower louvers.	B	○
	Left/right flap control	[Fixed position stop] or [Stop at any position] can be selected for the right and left louvers.	B	○
	Ventilation setting	Combination control for ventilator can be set.	B	○
	Auto-restart	The operation control method after recovery of power failure happened during operation can be set.	B	○
	Auto temp. setting	[Enable] or [Disable] of [Auto temp. setting] can be selected.	B	
	Auto fan speed	[Enable] or [Disable] of [Auto fan speed] can be selected.	B	
	3 IU settings [Service password]	Fan speed setting	The fan speed for indoor units can be set.	B
Filter sign		The setting of filter sign display timer can be done from following patterns.	B	○
External input 1		The connect of control by external input 1 can be changed.	B	○
External input 1 signal		The type of external input 1 signal can be changed.	B	○
External input 2		The connect of control by external input 2 can be changed.	B	
External input 2 signal		The type of external input 2 signal can be changed.	B	
Heating thermo-OFF temp adjustment		The judgement temp. of heating thermo-off can be adjusted within the range from 0 to +3°C (1°C interval)	B	△
Return temperature adjustment		The sensing temp. of return air temp. sensor built in the indoor unit can be adjusted within the range of ±2°C.	B	△
Fan control in cooling thermo-OFF		Fan control, when the cooling thermostat is turned OFF, can be changed.	B	○
Fan control in heating thermo-OFF		Fan control, when the heating thermostat is turned OFF, can be changed.	B	○
Anti-frost temp.		Judgment temperature for the anti-frost control during cooling can be changed.	B	○
Anti-frost control		When the anti-frost control of indoor unit in cooling is activated, the fan speed can be changed.	B	○
Drain pump operation		In any operation mode in addition to cooling and dry mode, the setting of drain pump operation can be done.	B	○
Keep fan operating after cooling is stopped		The time period residual fan operation after stopping or thermo-off in cooling mode can be set.	B	○
Keep fan operating after heating is stopped		The time period residual fan operation after stopping or thermo-off in heating mode can be set.	B	○
Intermittent fan operation in heating		The fan operation rule following the residual fan operation after stopping or thermo-off in heating mode can be set.	B	○
Fan circulator operation		In case that the fan is operated as the circulator, the fan control rule can be set.	B	
Control pressure adjust		When only the OA processing units are operated, control pressure value can be changed.	B	
Auto operation mode	The [Auto rule selection] for switching the operation mode automatically can be selected from 3 patterns.	B		
Thermo. rule setting	When selecting [Outdoor air temp. control], the judgment temp can be offset by outdoor temp..	B		
Auto fan speed control	Auto switching range for the auto fan speed control can be set.	B		
IU overload alarm	If the difference between the setting temperature and the suction temperature becomes larger than the temperature difference set for the overload alarm, at 30 minutes after the start of operation, the overload alarm signal is transmitted from the external output (CnT-5).	B		
4 Service & Maintenance [Service password]	External output setting	Functions assigned to the external outputs 1 to 4 can be changed.	B	
	IU address	Max 16 indoor units can be connected to one remote control, and all address No. of the connected indoor units can be displayed. • The indoor unit conforming to the address No. can be identified by selecting the address No. and tapping [Check] to operate the indoor fan.	B	○
	Next service date	The [Next service date] can be registered. • The [Next service date] and [Company information] is displayed on the message screen.	A B	○
	Operation data	The [Operation data] for indoor unit and outdoor unit can be displayed.	B	○
	Error display			
	Error history	The error history can be displayed.	B	△
	Display anomaly data	The operation data just before the latest error stop can be displayed.		
Erase anomaly data	Anomaly operation data can be erased.			
Reset periodical check	The timer for the periodical check can be reset.			
Saving IU settings	The I/U settings memorized in the indoor PCB connected to the remote control can be saved in the memory of the remote control.	B		
Special settings	[Erase IU address] [CPU reset] [Restore of default setting] [Touch panel calibration]	B	△	
Indoor unit capacity display	Address No. and capacities of indoor units connected to the remote control are displayed. Shows registered [Contact company] and [Contact phone].	B		
8. Contact company				
9. Inspection				
[Confirmation of Inspection]		This is displayed when any error occurs.	A	△
10. PC connection				
[USB connection]		Weekly timer setting and etc., can be set from PC.	C	

◆ Listed items may not function depending on the specifications of indoor and outdoor units which are combined.

● Model RC-E5

(1) Switching sequence of the operation mode switches of remote control



(2) CPU reset

This functions when “CHECK” and “ESP” buttons on the remote control are pressed simultaneously. Operation is same as that of the power source reset.

(3) Power failure compensation function (Electric power source failure)

- This becomes effective if “Power failure compensation effective” is selected with the setting of remote control function.
- Since it memorizes always the condition of remote control, it starts operation according to the contents of memory no sooner than normal state is recovered after the power failure. Although the auto swing stop position and the timer mode are cancelled, the weekly timer setting is restored with the holiday setting for all weekdays. After recovering from the power failure, it readjusts the clock and resets the holiday setting for each weekday so that the setting of weekly timer becomes effective.
- Content memorized with the power failure compensation are as follows.

Note (1) Items (f), (g) and (h) are memorized regardless whether the power failure compensation is effective or not while the setting of silent mode is cancelled regardless whether the power failure compensation is effective or not.

(a) At power failure – Operating/stopped

If it had been operating under the off timer mode, sleep timer mode, the state of stop is memorized. (Although the timer mode is cancelled at the recovery from power failure, the setting of weekly timer is changed to the holiday setting for all weekdays.)

(b) Operation mode

(c) Air flow volume mode

(d) Room temperature setting

(e) Louver auto swing/stop

However, the stop position (4-position) is cancelled so that it returns to Position (1).

(f) “Remote control function items” which have been set with the remote control function setting (“Indoor function items” are saved in the memory of indoor unit.)

(g) Upper limit value and lower limit value which have been set with the temperature setting control

(h) Sleep timer and weekly timer settings (Other timer settings are not memorized.)

[Parts layout on remote control PCB]

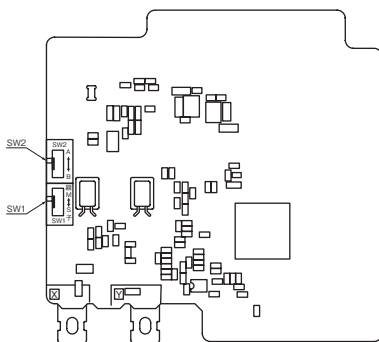

Master/ slave setting when more than one remote controls are used

A maximum of two remote controls can be connected to one indoor unit (or one group of indoor units.)

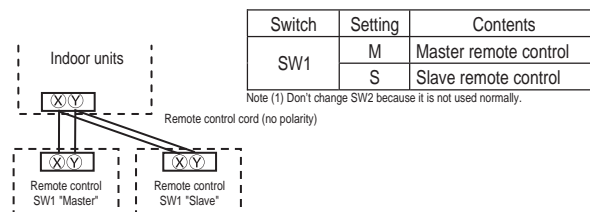

Caution

When using multiple remote controls, the following displays or settings cannot be done with the slave remote control. It is available only with the master remote control.

- ① Louver position setting (set upper or lower limit of swinging range)
- ② Setting indoor unit functions
- ③ Setting temperature range
- ④ Operation data display
- ⑤ Error data display
- ⑥ Silent mode setting
- ⑦ Test operation of drain pump
- ⑧ Remote control sensor setting

1.3 Operation control function by the indoor control

(1) Auto operation (Heat recovery 3-pipe combination systems only)

(a) If "Auto" mode is selected by the remote control, the heating and the cooling are automatically switched according to the difference between outdoor air temperature and setting temperature and the difference between setting temperature and indoor air temperature. (When the switching of cooling mode ↔ heating mode takes place within 3 minutes, the compressor does not operate for 3 minutes by the control of 3-minute timer.) This will facilitate the cooling/heating switching operation in intermediate seasons and the adaptation to unmanned operation at stores, etc (ATM corner of bank).

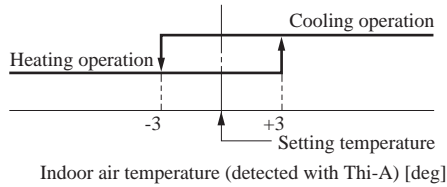

Notes (1) Temperature range of switching cooling/heating mode can be changed by RC-EX3 from ±1.0 - ±4.0.

(2) Indoor air temperature control during auto cooling/auto heating is performed according to the setting temperature. (DIFF: ±1 deg)

(3) If the indoor heat exchanger temperature rises to 59°C or higher during heating operation, it is switched automatically to cooling operation. In addition, for 1 hour after this switching, the heating operation is not performed, regardless of the temperature shown at right.

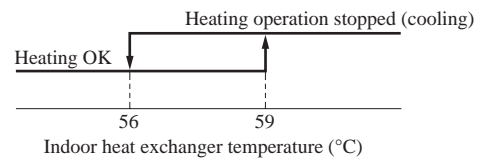

(b) The following automatic controls are performed other than (a) above. (Except FDTQ, FDUH, FDK, FDFW, FDFL, FDFU)

(i) Cooling or heating operation mode is judged according to the conditions of the "Judgment based on Setting temperature + Cooling select temperature and Indoor return air temperature" and the "Judgment based on Outdoor temperature".

- 1) In " $\text{Setting temperature} - \text{Cooling select temperature} < \text{Indoor return air temperature}$ " and " $\text{Outdoor temperature} / \text{Cooling} < \text{Outdoor air temperature}$ " ⇒ Operation mode: Cooling
- 2) " $\text{Setting temperature} + \text{Heating select temperature} > \text{Indoor return air temperature}$ " and " $\text{Outdoor temperature} / \text{Heating} > \text{Outdoor air temperature}$ " ⇒ Operation mode: Heating
- 3) The outdoor air temperature of the above judgment conditions is sampled at every 10 minutes.
- 4) In the range where the above cooling and heating zones are overlapped ⇒ Forced thermostat OFF

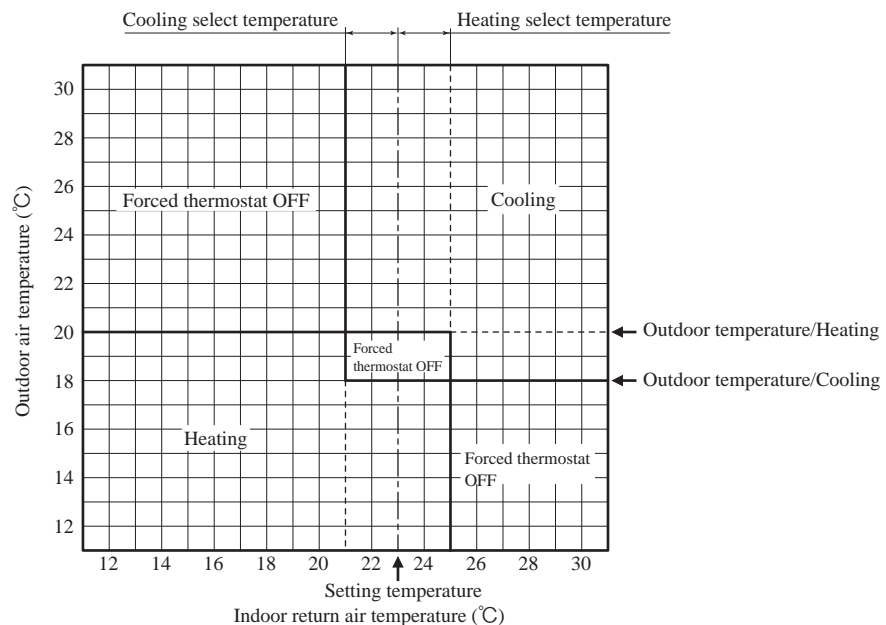

(ii) Regardless of the setting temperature, the cooling or heating operation mode is judged according to the "Judgment based on Room temperature/Cooling or Heating and Outdoor temperature/Cooling or Heating".

- 1) In case of "Room temperature/Cooling < Indoor return air temperature" and "Outdoor temperature/Cooling < Outdoor air temperature" ⇒ Operation mode: Cooling
- 2) In case of "Room temperature/Heating > Indoor return air temperature" and "Outdoor temperature /Heating > Outdoor air temperature" ⇒ Operation mode: Heating
- 3) The outdoor air temperature of the above judgment conditions is sampled at every 10 minutes.
- 4) In the range where the above cooling and heating zones are overlapped ⇒ Forced thermostat OFF

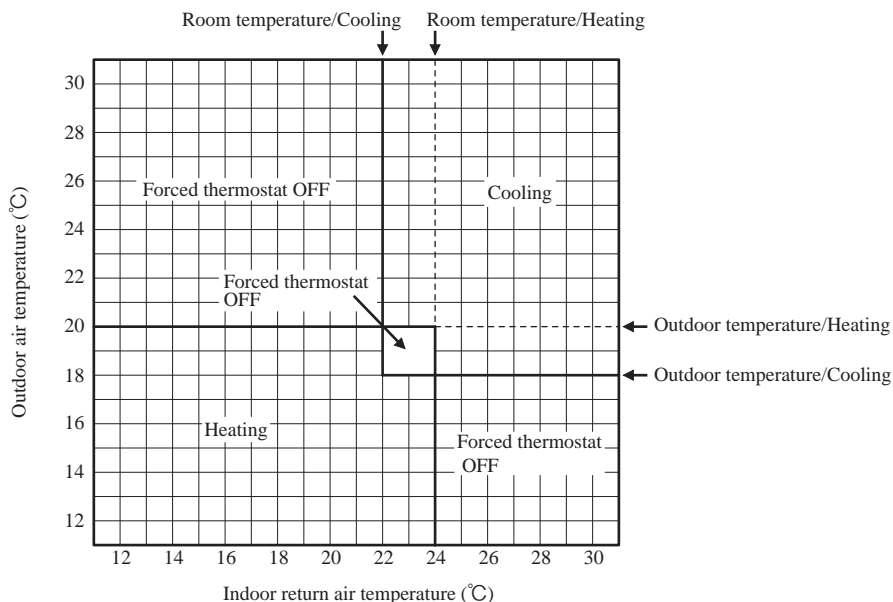

(2) Operations of functional items during cooling/heating

Functional item \ Operation	Cooling		Fan	Heating			Dehumidifying
	Thermostat ON	Thermostat OFF		Thermostat ON	Thermostat OFF	Hot start (Defrost)	
Compressor	○	×	×	○	×	○	○/×
4-way valve	×	×	×	○	○	○(×)	×
Outdoor unit fan	○	×	×	○	×	○(×)	○/×
Indoor unit fan	○	○	○	○/×	○/×	○/×	○/×
Drain pump ⁽³⁾	○	× ⁽²⁾	× ⁽²⁾	○/× ⁽²⁾			Thermostat ON:○ Thermostat OFF:× ⁽²⁾

Notes (1) ○: Operation ×: Stop ○/×: Turned ON/OFF by the control other than the room temperature control.
 (2) ON during the drain motor delay control.
 (3) Drain pump ON setting may be selected with the indoor unit function setting of the wired remote control.

(3) Dehumidifying (DRY) operation

Return air temperature thermistor [Thi-A (by the remote control when the remote control sensor is enabled)] controls the indoor temperature environment simultaneously.

- (a) Operation is started in the cooling mode. When the difference between the return air temperature and the setting temperature is 2°C or less, the indoor unit fan tap is brought down by one tap. That tap is retained for 3 minutes after changing the indoor unit fan tap.
- (b) If the return air temperature exceeds the setting temperature by 3°C during dehumidifying operation, the indoor unit fan tap is raised. That tap is retained for 3 minutes after changing the indoor unit fan tap.
- (c) If the thermostat OFF is established during the above control, the indoor unit fan tap at the thermostat ON is retained so far as the thermostat is turned OFF.

(4) Timer operation

(a) RC-EX3

- (i) **Sleep timer**
Set the time from the start to stop of operation. The time can be selected in the range from 30 to 240 minutes (in the unit of 10-minute).
Note (1) Enable the “Sleep timer” setting from the remote control. If the setting is enabled, the timer operates at every time.
- (ii) **Set OFF timer by hour**
Set the time to stop the unit after operation, in the range from 1 to 12 hours (in the unit of hour).
- (iii) **Set ON timer by hour**
Set the time to start the unit after the stop of operation, in the range from 1 to 12 hours (in the unit of hour). It is allowed also to set simultaneously the indoor temperature, operation mode, air flow rate and warm-up enabled/disabled.
- (iv) **Set ON timer by clock**
Set the time to start operation. The time can be set in the unit of 5-minute. This setting can be activated only once or at every time. It is allowed also to set simultaneously the indoor temperature, operation mode, air flow rate and warm-up enabled/disabled.
Note (1) It is necessary to set the clock to use this timer.
- (v) **Set OFF timer by clock**
Set the time to stop operation. The time can be set in the unit of 5-minute. This setting can be activated only once or at every time.
Note (1) It is necessary to set the clock to use this timer.
- (vi) **Weekly timer**
Set the ON or OFF timer for a week. Up to 8 patterns can be set for a day. The day-off setting is provided for holidays and non-business days.
Note (1) It is necessary to set the clock to use the weekly timer.

(vii) Combination of patterns which can be set for the timer operations

	Sleep time	Set OFF timer by hour	Set ON timer by hour	Set OFF timer by clock	Set ON timer by clock	Weekly timer
Sleep time		×	×	○	○	○
Set OFF timer by hour	×		×	×	×	×
Set ON timer by hour	×	×		×	×	×
Set OFF timer by clock	○	×	×		○	×
Set ON timer by clock	○	×	×	○		×
Weekly timer	○	×	×	×	×	

Note (1) ○: Allowed ×: Not

(b) RC-E5

- (i) **Sleep timer**
Set the duration of time from the present to the time to turn off the air-conditioner.
It can be selected from 10 steps in the range from “OFF 1 hour later” to “OFF 10 hours later”. After the sleep timer setting, the remaining time is displayed with progress of time in the unit of hour.
- (ii) **OFF timer**
Time to turn OFF the air-conditioner can be set in the unit of 10 minutes.
- (iii) **ON timer**
Time to turn ON the air-conditioner can be set. Indoor temperature can be set simultaneously.
- (iv) **Weekly timer**
Timer operation (ON timer, OFF timer) can be set up to 4 times a day for each weekday.
- (v) **Timer operations which can be set in combination**

Item	Timer	OFF timer	ON timer	Weekly timer
Timer		×	○	×
OFF timer	×		○	×
ON timer	○	○		×
Weekly timer	×	×	×	

Notes (1) ○: Allowed ×: Not

(2) Since the ON timer, sleep timer and OFF timer are set in parallel, when the times to turn ON and OFF the air-conditioner are duplicated, the setting of the OFF timer has priority.

(5) Remote control display during the operation stop

When the operation is stopped (the power source is turned ON), it displays preferentially the “Room temperature”, “Center/Remote”, “Filter sign”, “Inspection” and “Timer operation”.

(6) Hot start (Cold draft prevention at heating)**(a) Operating conditions**

When either one of following conditions either of (i) to (iv), the hot start control is performed.

- (i) From stop to heating operation
- (ii) From cooling to heating operation
- (iii) From heating thermostat OFF to ON
- (iv) After completing the defrost operation (only on units with thermostat ON)

(b) Contents of operation

- (i) Indoor fan motor control at hot start
 - 1) Within 7 minutes after starting heating operation, the fan mode is determined depending on the condition of thermostat (fan control with heating thermostat OFF).
 - a) Thermostat OFF
 - i) Operates according to the fan control setting at heating thermostat OFF.
 - ii) Even if it changes from thermostat OFF to ON, the fan continues to operate with the fan control at thermostat OFF till the heat exchanger thermistor (Thi-R1 or R2, whichever higher) detects 35°C or higher.
 - iii) When the heat exchanger thermistor (Thi-R1 or R2, whichever higher) detects 35°C or higher, the fan operates with the set airflow volume.
 - b) Thermostat ON
 - i) When the heat exchanger thermistor (Thi-R1 or R2, whichever higher) detects 25°C or lower, the fan is turned OFF and does not operate.
 - ii) When the heat exchanger thermistor (Thi-R1 or R2, whichever higher) detects 25°C or higher, the fan operates with the fan control at heating thermostat OFF.
 - iii) When the heat exchanger thermistor (Thi-R1 or R2, whichever higher) detects 35°C or higher, the fan operates with the set air flow volume.
 - c) If the fan control at heating thermostat OFF is set at the “Set air flow volume” (from the remote control), the fan operates with the set air flow volume regardless of the thermostat ON/OFF.
 - 2) Once the fan motor is changed from OFF to ON during the thermostat ON, the indoor fan motor is not turned OFF even if the heat exchanger thermistor detects lower than 25°C.

Note (1) When the defrost operation signal is received, it complies with the fan control during defrost operation.
 - 3) Once the hot start is completed, it will not restart even if the temperature on the heat exchanger thermistor drops.
- (ii) During the hot start, the louver is kept at the horizontal position.
- (iii) When the fan motor is turned OFF for 7 minutes continuously after defrost operation, the fan motor is turned ON regardless of the temperatures detected with the indoor heat exchanger thermistor (Thi-R1, R2).

(c) Ending condition

- (i) If one of following conditions is satisfied during the hot start control, this control is terminated, and the fan is operated with the set air flow volume.
 - 1) Heat exchanger thermistor (Thi-R1 or R2, whichever higher) detects 35°C or higher.
 - 2) It has elapsed 7 minutes after starting the hot start control.

(7) Hot keep

Hot keep control is performed at the start of the defrost operation.

(a) Control

- (i) When the indoor heat exchanger temperature (detected with Thi-R1 or R2) drops to 35°C or lower, the speed of indoor fan is changed to the lower tap at each setting.
- (ii) During the hot keep, the louver is kept at the horizontal position.

(b) Ending condition

When the indoor fan is at the lower tap at each setting, it returns to the set airflow volume as the indoor heat exchanger temperature rises to 45°C or higher.

(8) Auto swing control**(a) RC-EX3****(i) Louver control**

- 1) To operate the swing louver when the air-conditioner is operating, press the “Direction” button on the TOP screen of remote control. The wind direction select screen will be displayed.
- 2) To swing the louver, touch the “Auto swing” button. The lover will move up and down. To fix the swing louver at a position, touch one of [1] - [4] buttons. The swing lover will stop at the selected position.
- 3) Louver operation at the power on with a unit having the louver 4-position control function
The louver swings one time automatically (without operating the remote control) at the power on.
This allows the microcomputer recognizing and inputting the louver motor (LM) position.

(ii) Automatic louver level setting during heating

At the hot start and the heating thermostat OFF, regardless whether the auto swing switch is operated or not (auto swing or louver stop), the louver takes the level position (in order to prevent blowing of cool wind). The louver position display LCD continues to show the display which has been shown before entering this control.

(iii) Louver free stop control

If you touch the “Menu” → “Next” → “R/C settings” buttons one after another on the TOP screen of remote control, the “Flap control” screen is displayed. If the free stop is selected on this screen, the louver motor stops upon receipt of the stop signal from the remote control. If the auto swing signal is received from the remote control, the auto swing will start from the position before the stop.

(b) RC-E5**(i) Louver control**

- 1) Press the “LOUVER” button to operate the swing louver when the air-conditioner is operating.
“SWING 

Note (1) If you press the “LOUVER” button, the swing motion is displayed on the louver position LCD for 10 second. The display changes to the “SWING **(ii) Automatic louver level setting during heating**

At the hot start with the heating thermostat OFF, regardless whether the auto swing switch is operated or not (auto swing or louver stop), the louver takes the level position (In order to prevent the cold start). The louver position display LCD continues to show the display which has been shown before entering this control.

(iii) Louver-free stop control

When the louver-free stop has been selected with the indoor function of wired remote control “

Note (1) When the indoor function of wired remote control “- 13 -

(9) Thermostat operation

(a) Cooling

- (i) Thermostat is operated with the room temperature control.
- (ii) Thermostat is turned ON or OFF relative to the set room temperature as shown below.

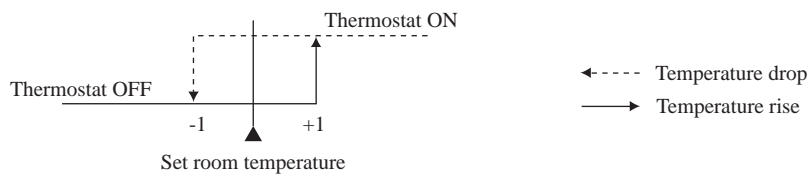

- (iii) Thermostat is turned ON when the room temperature is in the range of $-1 < \text{Set temperature} < +1$ at the start of cooling operation (including from heating to cooling).

(b) Heating

- (i) Thermostat is operated with the room temperature control.
- (ii) Thermostat is turned ON or OFF relative to the set room temperature as shown below.

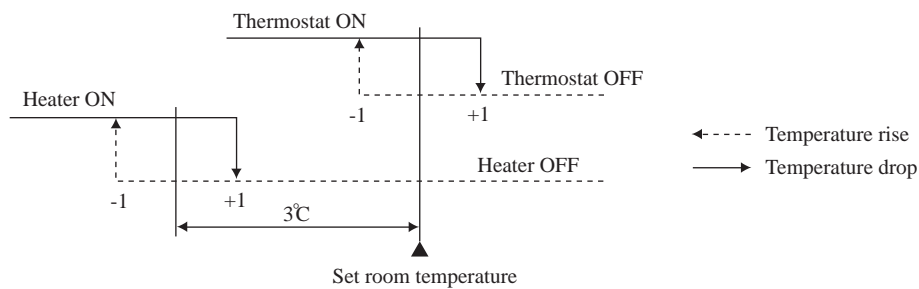

- (iii) Thermostat is turned ON when the room temperature is in the range of $-1 < \text{Set point} < +1$ at the start of cooling operation (including from cooling to heating).

(c) Fan control during heating thermostat OFF

- (i) Following fan controls during the heating thermostat OFF can be selected with the indoor function setting of the wired remote control.
 - ① Low fan speed (Factory default), ② Set fan speed, ③ Intermittence, ④ Fan OFF
- (ii) When the “Low fan speed (Factory default)” is selected, the following taps are used for the indoor fans.
 - For DC motor : ULo tap · For AC moter : Lo tap
- (iii) When the “Set fan speed” is selected, it is operated with the set fan speed also in the thermostat OFF condition.
- (iv) If the “Intermittence” is selected, following controls are performed:
 - 1) If the thermostat is turned OFF during the heating operation, the indoor unit fan motor stops.
 - 2) Indoor fan OFF is fixed for 5 minutes. After the 5 minutes, the indoor fan is operated at ULo or Lo for 2 minutes. In the meantime the louver is controlled at level.
 - 3) After operating at ULo or Lo for 2 minutes, the indoor fan moves to the state of 1) above.
 - 4) If the thermostat is turned ON, it moves to the hot start control.
 - 5) When the heating thermostat is turned OFF, the remote control displays the temperature detected at the fan stop and revises the temperature later when the indoor fan changes from ULo or Lo to stop. The remote control uses the operation data display function to display temperatures and updates values of temperature even when the indoor fan is turned OFF.
 - 6) When the defrost operation starts while the heating thermostat is turned OFF or the thermostat is turned OFF during defrost operation, the indoor fan is turned OFF. (Hot keep or hot start control takes priority.) However, the suction temperature is updated at every 7-minute.
 - 7) When the heating thermostat is turned ON or the operation is changed to another mode (including stop), this control is stopped immediately, and the operating condition is restored.
- (v) When the “Fan OFF” is selected, the fan on the indoor unit of which the thermostat has been turned OFF, is turned OFF. The same occurs also when the remote control sensor is effective.

(d) Fan control during cooling thermostat OFF (Except FDTC, FDTQ, FDUT15-56, FDUH, FDK, FDFW, FDFL, FDFU)

- (i) Following fan controls during the cooling thermostat OFF can be selected with the indoor function setting of the wired remote control.
 - ① Low fan speed, ② Set fan speed (Factory default), ③ Intermittence, ④ Fan OFF
- (ii) When the “Low fan speed” is selected, the following taps are used for the indoor fans.
 - For DC motor : ULo tap
- (iii) When the “Set fan speed” is selected, it is operated with the set fan speed also in the thermostat OFF condition.
- (iv) If the “Intermittence” is selected, following controls are performed:
 - 1) If the thermostat is turned OFF during the cooling operation, the indoor unit fan motor stops.
 - 2) Indoor fan OFF is fixed for 5 minutes. After the 5 minutes, the indoor fan is operated at ULo for 2 minutes.
 - 3) After operating at ULo for 2 minutes, the indoor fan moves to the state of 1) above.
 - 4) If the thermostat is turned ON, the fan starts operation at set fan speed.
 - 5) When the cooling thermostat is turned OFF, the remote control displays the temperature detected at the fan stop and revises the temperature later when the indoor fan changes from ULo to stop.

By using operation data display function at wireless remote control, the temperature as displayad and the value is updated including the fan stops.
- 6) When the cooling thermostat is turned ON or the operation is changed to another mode (including stop), this control is stopped immediately, and the operating condition is restored.
- (v) When the “Fan OFF” is selected, the fan on the indoor unit of which the thermostat has been turned OFF, is turned OFF. The same occurs also when the remote control sensor is effective.

(10) Filter sign

As the operation time (Total ON time of ON/OFF switch) accumulates to 180 hours (1), “FILTER CLEANING” is displayed on the remote control. (This is displayed when the unit is in trouble and under the central control, regardless of ON/OFF)

Notes (1) Time setting for the filter sign can be made as shown below using the indoor function of wired remote control “FILTER SIGN SET”. (It is set at Setting 1 at the shipping from factory.)

Filter sign setting	Function
Setting 1	Setting time: 180 hrs (Factory default)
Setting 2	Setting time: 600 hrs
Setting 3	Setting time: 1,000 hrs
Setting 4	Setting time: 1,000 hrs (Unit stop) ⁽²⁾

(2) After the setting time has elapsed, the “FILTER CLEANING” is displayed and, after operating for 24 hours further (counted also during the stop), the unit stops.

(11) Compressor inching prevention control

- (a) Once the indoor unit thermostat has been turned ON, the thermostat is not turned OFF for 2 minutes (*1) after the compressor ON even if the thermostat is turned OFF at the state of item (9).
 If the thermostat is turned ON-OFF repeatedly on an indoor unit when the outdoor air temperature is low, however, a command “Do not turn OFF the thermostat for 10 minutes after the compressor ON” may be sent from the outdoor unit to the indoor unit, in order to protect the compressor.

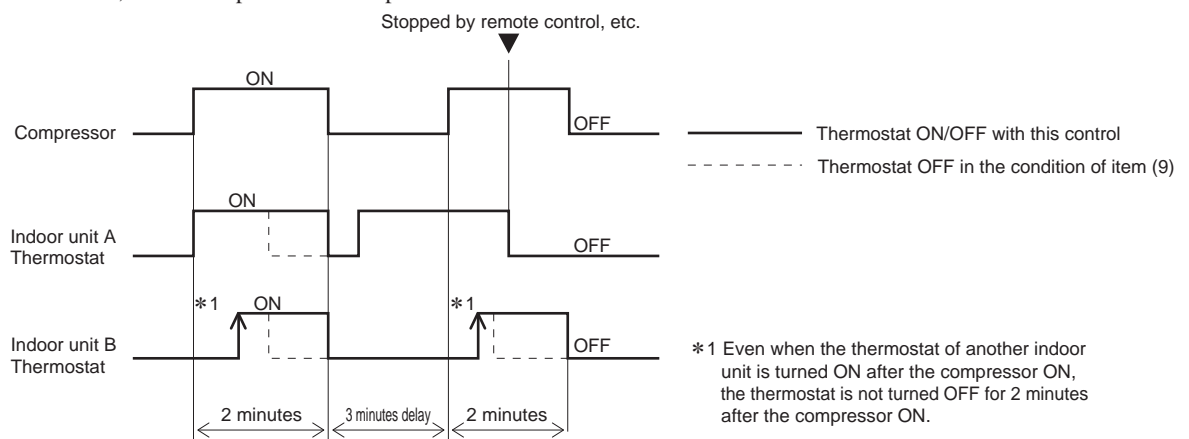

- (b) When the oil return control has started while the thermostat is turned ON, the thermostat is not turned OFF even if the thermostat OFF condition is satisfied during the oil return control.

(12) Drain pump control

- (a) This control is operated when the inverter frequency is other than 0 rps during the cooling operation and automatic cooling and dehumidifying operations.
- (b) Drain pump ON condition continues for 5 (Models FDU224, 280 · FDU1800, 2400F:20) minutes even when it enters the OFF range according to (i) above after turning the drain pump ON, and then stops. The 5 (Models FDU224, 280 · FDU1800, 2400F:20) minute delay continues also in the event of anomalous stop.
- (c) The drain pump is operated with the 5 (Models FDU224, 280 · FDU1800, 2400F:20) minute delay operation when the compressor is changed from ON to OFF.
- (d) Even in conditions other than the above (such as heating, fan, stop, cooling thermostat OFF), the drain pump control is performed by the drain detection.
- (e) Following settings can be made using the indoor function setting of the wired remote control.
 - (i) [Standard (in cooling & dehumidifying)] : Drain pump is run during cooling and dehumidifying.
 - (ii) [Operate in standard & heating] : Drain pump is run during cooling, dehumidifying and heating.
 - (iii) [Operate in heating & fan] : Drain pump is run during cooling, dehumidifying, heating and fan.
 - (iv) [Operate in standard & fan] : Drain pump is run during cooling, dehumidifying and fan.

Note (1) Values in [] are for the RC-EX3 model.

(13) Drain pump abnormalities detection

- (a) Drain detection switch is turned ON or OFF with the float switch (FS) and the timer.

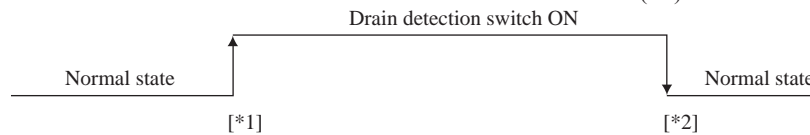

[* 1] Drain detection switch is turned “ON” when the float switch “Open” is detected for 3 seconds continuously in the drain detectable space.

[* 2] Drain detection switch is turned “OFF” when the float switch “Close” is detected for 10 seconds continuously.

- (i) It detects always from 30 seconds after turning the power ON.
 - 1) There is no detection of anomalous draining for 10 seconds after turning the drain pump OFF.
 - 2) Turning the drain detection switch “ON” causes to turn ON the drain pump forcibly.
 - 3) Turning the drain detection switch “OFF” releases the forced drain pump ON condition.
- (b) Indoor unit performs the control A or B depending on each operating condition.

	Indoor unit operation mode				
	Stop ⁽¹⁾	Cooling	Dry	Fan ⁽²⁾	Heating
Compressor ON		Control A			
Compressor OFF		Control B			

Notes (1) Including the stop from the cooling, dehumidifying, fan and heating, and the anomalous stop
 (2) Including the “Fan” operation according to the mismatch of operation modes

- (i) Control A
 - 1) If the float switch detects any anomalous draining condition, the unit stops with the anomalous stop (displays E9) and the drain pump starts. After detecting the anomalous condition, the drain motor continues to be ON.
 - 2) It keeps operating while the float switch is detecting the anomalous condition.
- (ii) Control B

If the float switch detects any anomalous drain condition, the drain motor is turned ON for 5 (Models FDU224, 280 · FDU1800, 2400F:20) minutes, and at 10 seconds after the drain motor OFF it checks the float switch. If it is normal, the unit is stopped under the normal mode or, if there is any anomalous condition, E9 is displayed and the drain motor is turned ON. (The ON condition is maintained during the drain detection.)

(14) Operation check/drain pump test run operation mode

- (a) If the power is turned on by the dip switch (SW7-1) on the indoor PCB when electric power source is supplied, it enters the mode of operation check/drain pump test run. It is ineffective (prohibited) to change the switch after turning power on.
- (b) When the communication with the remote control has been established within 60 seconds after turning power on by the dip switch (SW7-1) ON, it enters the operation check mode. Unless the remote control communication is established, it enters the drain pump test run mode.

Note (1) To select the drain pump test run mode, disconnect the remote control connector (CNB) on the indoor PCB to shut down the remote control communication.

- (c) Operation check mode
There is no communication with the heat source unit but it allows performing operation in respective modes by operating the remote control.
- (d) Drain pump test run mode
As the drain pump test run is established, the drain pump only operates and during the operation protective functions by the microcomputer of indoor unit become ineffective.

(15) Cooling, dehumidifying frost protection

To prevent frosting during cooling mode or dehumidifying mode operation, the of thermostat-OFF if the indoor heat exchanger temperature (detected with Thi-R) drops to 1.0 °C or lower at 4 minutes after the thermostat-ON. If the indoor unit heat exchanger temperature is 1.0 °C or lower after 5 minutes, the indoor unit is controlled thermostat-OFF. If it becomes 10°C or higher, the control terminates. When the indoor heat exchanger temperature has become as show, the indoor unit send heat source unit the “Anti-frost” signal.

- Frost prevention temperature setting can be selected with the indoor unit function setting of the wired remote control.

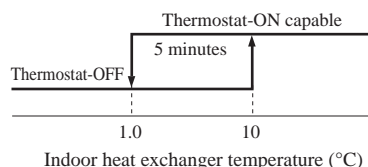

Item	Symbol	A
Temperature - Low (Factory default)		1.0
Temperature - High		2.5

(16) Anomalous fan motor

- (a) After starting the fan motor, if the fan motor speed is 200min⁻¹ or less is detected for 30 seconds continuously and 4 times within 60 minutes, then fan motor stops with the anomalous stop (E16).
- (b) If the fan motor fails to reach at -50 (FDU:-500) min⁻¹ less than the required speed, it stops with the anomalous stop (E20).

(17) High ceiling control

When sufficient air flow rate cannot be obtained from the indoor unit which is installed at a room with high ceiling, the air flow rate can be increased by changing the fan tap. To change the fan tap, use the indoor unit function “FAN SPEED SET” on the wired remote control.

Fan tap		Indoor unit air flow setting				Series
		●●●● - ●●●● - ●●●● - ●●●●	●●●● - ●●●● - ●●●●	●●●● - ●●●●	●●●● - ●●●●	
FAN SPEED SET	STANDARD	P-Hi1 - Hi - Me - Lo	Hi - Me - Lo	Hi - Lo	Hi - Me	Except FDT, FDE
		P-Hi2 - Hi - Me - Lo	Hi - Me - Lo	Hi - Lo	Hi - Me	Only FDT, FDE
	HIGH SPEED1	P-Hi1 - PHi1 - Hi - Me	P-Hi1 - Hi - Me	P-Hi1 - Me	P-Hi1 - Hi	Except FDT, FDTW, FDTS, FDE
		P-Hi2 - PHi1 - Hi - Me	P-Hi1 - Hi - Me	P-Hi1 - Me	P-Hi1 - Hi	Only FDT, FDTW, FDTS
		P-Hi1 - Hi - Me - Lo	Hi - Me - Lo	Hi - Lo	Hi - Me	Only FDE
	HIGH SPEED2	P-Hi2 - Hi - Me - Lo	Hi - Me - Lo	Hi - Lo	Hi - Me	Only FDT, FDTW, FDTS, FDE

Notes (1) Factory default is STANDARD.

(2) At the hot start and heating thermostat OFF, or other, the indoor unit fan is operated at the low speed tap of each setting.

(3) This function is not able to be set with wireless remote controls or simple remote control (RCH-E3)

(18) Abnormal temperature thermistor (return air/indoor heat exchanger) wire/short-circuit detection

- (a) Broken wire detection
When the return air temperature thermistor detects -20°C or lower or the heat exchanger temperature thermistor detect -40°C or lower for 5 seconds continuously, the compressor stops. After a 3-minute delay, the compressor restarts but, if it is detected again within 60 minutes after the initial detection for 6 minutes continuously, stops again (the return air temperature thermistor: E7, the heat exchanger temperature thermistor: E6).
- (b) Short-circuit detection
If the heat exchanger temperature thermistor detects 70°C or higher for 5 seconds continuously at 2 minutes and 20 seconds after the compressor ON during cooling operation, the compressor stops (E6).

(19) External input/output control (CnT or CnTA)

Be sure to connect the wired remote control to the indoor unit. Without wired remote control remote operation by CnT is not possible to perform.

• CnT

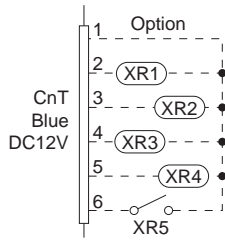

- ① Operation output (CnT-2: XR1)
- ② Heating output (CnT-3: XR2)
- ③ Thermostat ON output (CnT-4: XR3)
- ④ Error output (CnT-5: XR4)
- ⑤ Remote operation input (CnT-6: Volt-free contact)

• CnTA

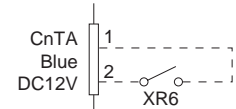

Note (1) CnTA function can be changed by RC-EX3.

■ Priority order for combinations of CnT and CnTA input.

		CnTA						
		① Operation stop level	② Operation stop pulse	③ Operation permission/prohibition	④ Operation permission/prohibition pulse	⑤ Cooling/heating selection level	⑥ Cooling/heating selection pulse	⑦ Emergency stop
CnT	① Operation stop level	CnT ①	CnT ①	CnT ① + CnTA ②	CnT ①	CnT ① / CnTA ⑤	CnT ① / CnTA ⑥	CnT ① < CnTA ⑦
	② Operation stop pulse	CnT ②	CnT ②	CnT ② + CnTA ③	CnT ②	CnT ② / CnTA ⑤	CnT ② / CnTA ⑥	CnT ② < CnTA ⑦
	③ Operation permission/prohibition level	CnT ③ > CnTA ①	CnT ③ > CnTA ②	CnT ③ + CnTA ③	CnT ③	CnT ③ / CnTA ⑤	CnT ③ / CnTA ⑥	CnT ③ < CnTA ⑦
	④ Operation permission/prohibition pulse	CnT ④	CnT ④	CnT ④ + CnTA ③※	CnT ④	CnT ④ / CnTA ⑤	CnT ④ / CnTA ⑥	CnT ④ < CnTA ⑦
	⑤ Cooling/heating selection level	CnT ⑤ / CnTA ①	CnT ⑤ / CnTA ②	CnT ⑤ / CnTA ③※	CnT ⑤ / CnTA ④	CnT ⑤	CnT ⑤	CnT ⑤ / CnTA ⑦
	⑥ Cooling/heating selection pulse	CnT ⑥ / CnTA ①	CnT ⑥ / CnTA ②	CnT ⑥ / CnTA ③	CnT ⑥ / CnTA ④	CnT ⑥	CnT ⑥	CnT ⑥ / CnTA ⑦
	⑦ Emergency stop	CnT ⑦ > CnTA ①	CnT ⑦ > CnTA ②	CnT ⑦ > CnTA ③	CnT ⑦ > CnTA ④	CnT ⑦ / CnTA ⑤	CnT ⑦ / CnTA ⑥	CnT ⑦ + CnTA ⑦

Note (1) Following operation commands are accepted when the operation prohibition is set with CnTA as indicated with *.

Individual operation command from remote control, test run command from outdoor unit and operation command from option device, CnT input.

Reference: Explanation on the codes and the combinations of codes in the table above

1. In case of CnT “Number”, the CnT “Number” is adopted and CnTA is invalidated.
 2. In case of CnTA “Number”, the CnTA “Number” is adopted and CnT is invalidated.
 3. In case of CnT “Number”/CnTA “Number”, the CnT “Number” and the CnTA “Number” become independent functions each other.
 4. In case of CnT “Number” + CnTA “Number”, the CnT “Number” and the CnTA “Number” become competing functions each other.
 5. In case of CnT “Number” > CnTA “Number”, the function of CnT “Number” supersedes that of CnTA “Number”.
 6. In case of CnT “Number” < CnTA “Number”, the function of CnTA “Number” supersedes that of CnT “Number”.
- (The “Number” above means ① - ⑦ in the table.)

(a) Output for external control (Remote display)

Following output connectors (CnT) are provided on the indoor control PCB for monitoring operation status.

- ① **Operation output:** Outputs DC12V signal for driving relay during operation
- ② **Heating output:** Outputs DC12V signal for driving relay during heating operation
- ③ **Thermostat ON output:** Outputs DC12V signal for driving relay when compressor is operating.
- ④ **Error output:** Outputs DC12V signal for driving relay when anomalous condition occurs.

(b) Remote operation input

Remote operation input connector (CnT-6 or CnTA) is provided on the indoor control PCB.

However remote operation by CnT-6 or CnTA is not effective, when “Center mode” is selected by central control.

Only the “LEVEL INPUT” is acceptable for external input. however when the indoor function setting of “Level input (Factory default)” or “Pulse input” is selected by the function for “External input” of the wired remote control, operation status will be changed as follows.

(i) In case of “Level input” setting (Factory default)

Input signal to CnT-6 or CnTA is OFF→ON unit ON

Input signal to CnT-6 or CnTA is ON→OFF unit OFF

Operation is not inverted.

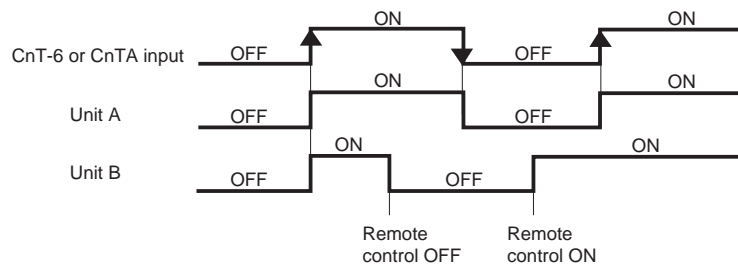

Note: The latest operation has priority

It is available to operate/stop by remote control or central control.

(ii) In case of “Pulse input” setting (Local setting)

It is effective only when the input signal to CnT-6 or CnTA is changed OFF→ON, and at that time unit operation [ON/OFF] is inverted.

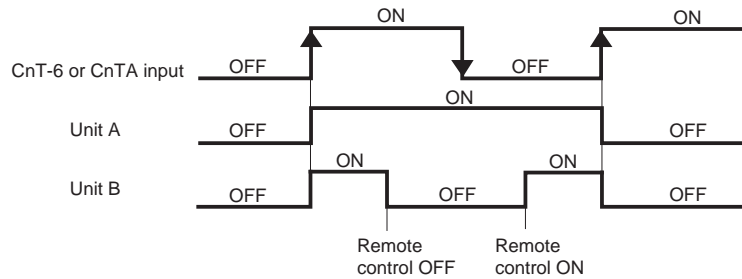

(c) Emergency stop signal processing

When the external signal input is used to stop operation, the remote stop signal is input at CnT or CnTA. This input is effective only on indoor units which can receive it. Where two or more indoor units are controlled with a wired remote control on the system, on which the external input is set at the “Same operation on all units”, if the stop signal is input at CnT on an indoor unit, all units connected to the wired remote control can be controlled collectively. This emergency stop signal is used to stop in emergencies all indoor units connected to the same outdoor unit.

- (i) The emergency stop control is enabled by selecting the “Valid” for the emergency stop control on the wired remote control.
- (ii) If the emergency stop [E-63] is received from the outdoor unit, it is transmitted to the wired remote control so that all indoor units are stopped.

(20) Operation permission/prohibition

(In case of adopting card key switches or commercially available timers)

When the indoor function setting of wired remote control for “Operation permission/prohibition” is changed from “Invalid (Factory default)” to “Valid”, following control becomes effective.

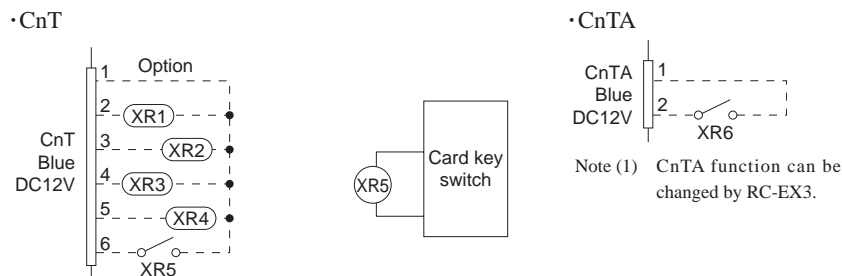

	Normal operation (Factory default)		Operation permission/prohibition mode “Valid” (Local setting)	
	ON	OFF	ON	OFF
CnT-6 or CnTA	Operation	Stop	Operation permission*1	Operation prohibition (Unit stops)

*1 **Only the “LEVEL INPUT” is acceptable for external input**, however when the indoor function setting of “Level input (Factory default)” or “Pulse input” is selected by the function for “External input” of the wired remote control, operation status will be changed as follows.

In case of “Level input” setting	In case of “Pulse input” setting
Unit operation from the wired remote control becomes available*(1)	Unit starts operation *(2)

*(1) In case that “Operation permission/prohibition mode” setting is “Valid” and “External input” setting is “Level input (Factory default)”;

- ① When card key switch is ON (CnT-6 or CnTA ON: Operation permission), start/stop operation of the unit from the wired remote control becomes available.
- ② When card key switch is OFF (CnT-6 or CnTA OFF: Operation prohibition), the unit stops operation in conjunction with OFF signal, and start/stop operation of the unit from the wired remote control becomes not available.

- * (2) In case that “Operation permission/prohibition mode” setting is “Valid” and “External input” setting is “Pulse input (Local setting)”;
- ① When card key switch is ON (Operation permission), the unit starts operation in conjunction with ON signal, and also start/stop operation of the unit from the wired remote control becomes available.
 - ② When card key switch is OFF (Operation prohibition), the unit stops operation in conjunction with OFF signal, and start/stop operation of the unit from the wired remote control becomes not available.
- (3) This function is invalid only at “Center mode” setting done by central control.

(a) In case of CnT ① Operation stop level > CnTA ③ Operation permission/prohibition level

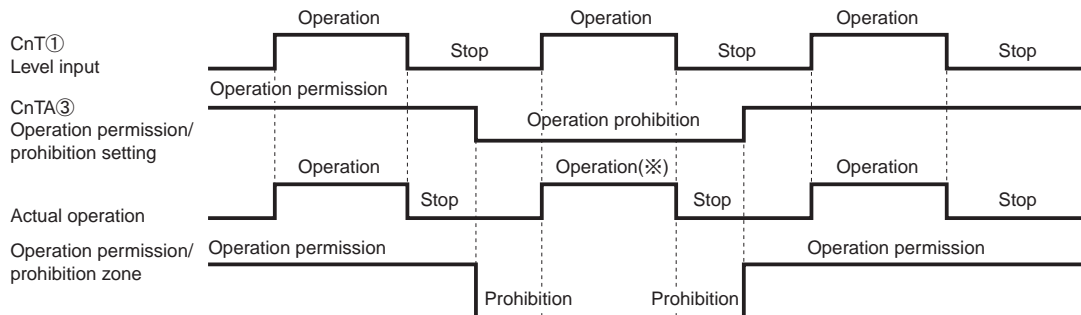

(※) CnT level input supersedes CnTA operation prohibition.

(b) In case of CnT ③ Operation permission/prohibition level + CnTA ③ Operation permission/prohibition level

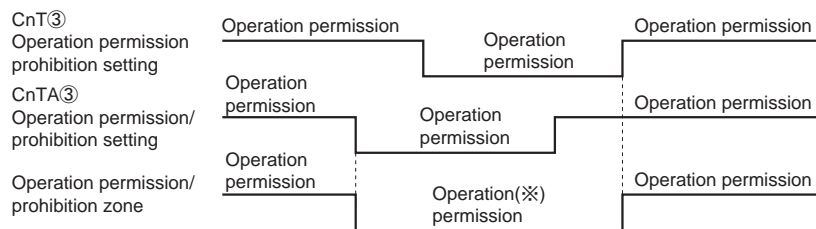

(※) Operation prohibition zone is determined by the OR judgment between CnT Operation prohibition zone and CnTA operation prohibition zone.

(c) In case of CnT ③ Operation permission/prohibition level > CnTA ② Operation/stop pulse

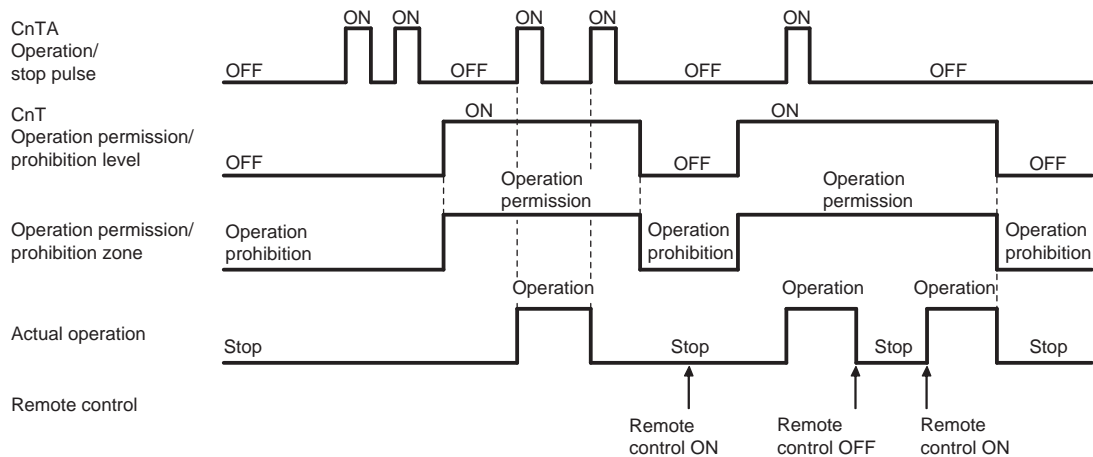

Note (1) If it is prohibited by CnT, all “Operation” and “Stop” commands are not accepted.

(d) In case of CnT ② Operation/stop pulse + CnTA ③ Operation permission/prohibition level

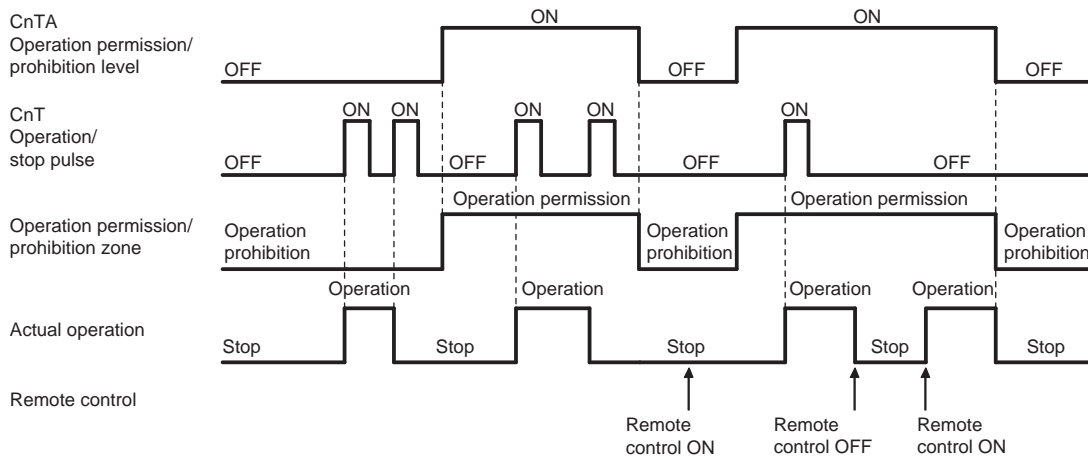

(21) Selection of cooling/heating external input function

- (a) When “External input 1 setting: Cooling/heating” is set for the indoor unit function from remote control, the cooling or heating is selected with CnT-6 or CnTA.
- (b) When the External input 1 method selection: Level input is set for the indoor unit function:
 - CnT-6 or CnTA: OPEN → Cooling operation mode
 - CnT-6 or CnTA: CLOSE → Heating operation mode
- (c) When the External input 1 method selection: Pulse input is set for the indoor unit function:
If the external input is changed OPEN → CLOSE, operation modes are inverted (Cooling → Heating or Heating → Cooling).
- (d) If the cooling/heating selection signal is given by the external input, the operation mode is transmitted to the remote control.

■ Selection of cooling/heating external input function

External input selection	External input method	Operation	
External input selection Cooling/heating selection	⑤ Level	External terminal input (CnT or CnTA)	
		Cooling/heating	
		Cooling/heating (Competitive)	
	⑥ Pulse	External terminal input (CnT or CnTA)	
		Cooling/heating	
		Cooling/heating (Competitive)	

Notes (1) Regarding the priority order for combinations of CnT and CnTA, refer to Page 18.

(22) Room temperature detection temperature compensation during heating

With the standard specification, the compressor is turned ON/OFF with the thermostat setting temperature. When the thermostat is likely to turn OFF earlier because the unit is installed at the ceiling where warm air tends to accumulate, the setting can be changed with the wired remote control indoor unit function “※ SP OFFSET”. The compressor and the heater are turned ON/OFF at one of the setting temperature +3, +2 or +1°C in order to improve the feeling of heating. The setting temperature, however, has the upper limit of 30°C.

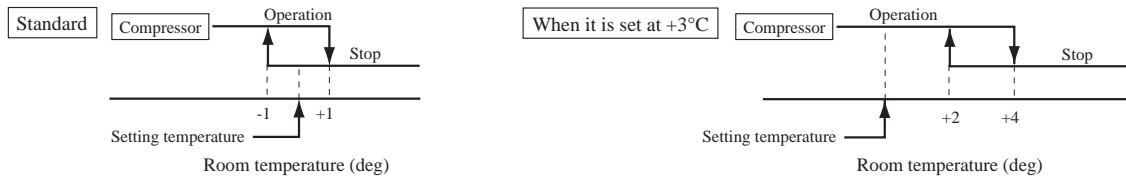

(23) Return air temperature compensation

This is the function to compensate the deviation between the detection temperature by the return air temperature thermistor and the measured temperature after installing the unit.

- (a) It is adjustable in the unit of 0.5°C with the wired remote control indoor unit function “RETURN AIR TEMP”.
 - +1.0°C, +1.5°C, +2.0°C
 - -1.0°C, -1.5°C, -2.0°C
- (b) Compensated temperature is transmitted to the remote control and the compressor to control them.

Note (1) The detection temperature compensation is effective on the indoor unit thermistor only.

(24) Branching control (Heat recovery 3-pipe combination systems only)

- (a) New control with new branching control (New Superlink control)
Control by means of CnT2 (The compressor does not stop at the switching of heating/cooling.)
CnT outputs – XR2: Heating output, XR3: Compressor ON thermostat output
 - (b) Old control with new branching control (Old Superlink control)
Control by means of CnT2 (The compressor stops at the switching of heating/cooling.)
 - (c) Control of the branching control when the heating/cooling is switched with the CnT2 output
 - ① 20S control (CnT2-2: XB1)
 - ② SVH control (CnT2-3: XB2)
 - ③ SVG control (CnT2-4: XB3)
 - ④ SVE control (CnT2-5: XB4)
- Combination of XB1 – XB4 outputs (The branching control is controlled in the state of operations (I) – (V).)

State of operation	XB1	XB2	XB3	XB4
(I) Cooling (Full stop, defrosting)	×	×	×	×
(II) Heating	○	○	×	×
(III) Oil return	×	○	○	×
(IV) Equalizing 1 (Cooling→Heating, etc.)	○	×	×	×
(V) Equalizing 2 (Heating→Cooling)	○	×	×	○

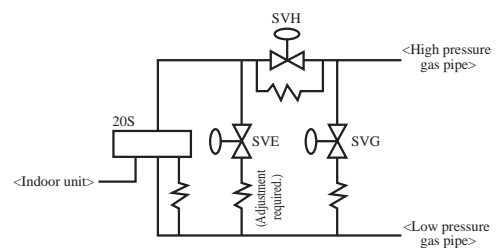

(25) Multiple indoor units control (Heat recovery 3-pipe combination systems only)

- (a) The indoor unit that controls the branching control directly is named as the master unit.
 - (i) Other indoor units that are connected to the same branching control are named as the slave unit.
 - (ii) Specify the “Master” or “Slave” for the indoor units from the remote control.
- (b) Change of operation modes from the remote control, option control or other external device can be made for the master unit only. It cannot be made for slave units.
- (c) Operation mode of slave units is always same as that of the master unit.
- (d) Any setting other than the operation mode can be made individually for the master and slave units.

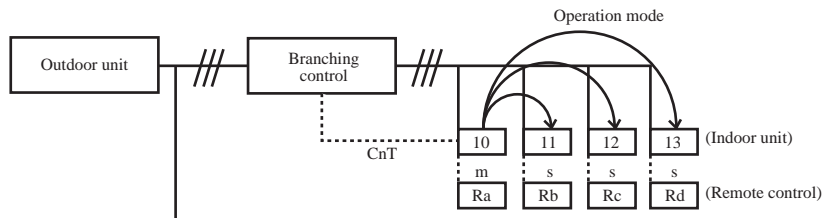

- (i) Set the indoor unit 10 as the “Master” from the remote control Ra.
- (ii) Set each of indoor units 11 – 13 as the “Slave” from the remote controls Rb – Rd.
- (iii) Set the operation mode at cooling for the indoor unit 10 from the remote control Ra.
 - ⇒ The indoor unit 10 commands the cooling for the operation mode of “Slave” indoor units. It commands the cooling in the same way also for the operation mode of “Slave” indoor units which are stopped.
 - When an operation mode change command for the indoor unit 10 is received from the central control device, the command is released to the “Slave” indoor units in the same way.
- (iv) Even if an operation mode change is commanded to the “Slave” indoor units 11, 12 and 13 from the remote control Rd, Rc, Rd or the central control device, the operation mode is not changed.

(26) High power operation (RC-EX3 only)

It operates at with the setting temperature fixed at 16°C for cooling, 30°C for heating and maximum indoor fan speed for 15 minutes maximum.

(27) Energy-saving operation (RC-EX3 only)

It operates with the setting temperature fixed at 28°C for cooling, 22°C for heating or 25°C for auto. (Maximum capacity is restricted at 80%.)

(28) Warm-up control (RC-EX3 only)

Operation will be started 5 to 60 minutes before use according to the forecast made by the microcomputer which calculates when the operation should be started in order to warm up the indoor temperature near the setting temperature at the setting time of operation start.

(29) Home leave mode (RC-EX3 only)

When the unit is not used for a long period of time, the room temperature is maintained at a moderate level, avoiding extremely hot or cool temperature.

- (a) Cooling or heating is operated according to the outdoor temperature (factory setting 35°C for cooling, 0°C for heating) and the set temperature. (Factory setting 33°C for cooling, 10°C for heating)
- (b) Set temp and indoor fan speed can be set by RC-EX3.

(30) Auto temp. setting (RC-EX3 only)

Setting temperature is adjusted automatically at the adequate temperature the center set temperature is 24°C by correcting the outdoor air temperature.

(31) Fan circulator operation (RC-EX3 only)

When the fan is used for circulation, the unit is operated as follows depending on the setting with the remote control.

- (a) If the invalid is selected with the remote control, the fan is operated continuously during the fan operation. (normal fan mode)
- (b) If the valid is selected with the remote control, the fan is operated or stopped when on the difference of the remote control temperature sensor and the indoor unit return air temperature sensor becomes bigger than 3°C.

(32) The operation judgment is executed every 5 minutes (RC-EX3 only)

Setting temperature T_s is changed according to outdoor temperature

This control is valid with cooling and heating mode. (NOT auto mode)

- (a) Operate 5 minutes forcedly.
- (b) Setting temperature is adjusted every 10 minutes.
 - (i) Cooling mode.
 $T_s = \text{Outdoor temperature} - \text{Offset value}$
 - (ii) Heating mode.
 $T_s = \text{Outdoor temperature} - \text{Offset value}$
- (c) If the return air temperature lower than 18°C or return air temperature becomes lower than 25°C, unit goes thermo OFF.

(33) Auto fan speed control (RC-EX3 only)

In order to reach the room temperature to the set temperature as quickly as possible, the airflow rate is increased when the set temperature of thermostat differs largely from the return air temperature. According to temperature difference between set temperature and return air temperature, indoor fan tap are controlled automatically.

- Auto 1: Changes the indoor unit fan tap within the range of Hi ↔ Me ↔ Lo.
- Auto 2: Changes the indoor unit fan tap within the range of P-Hi ↔ Hi ↔ Me ↔ Lo.

(34) Indoor unit overload alarm (RC-EX3 only)

If the following condition is satisfied at 30 minutes after starting operation, RC-EX3 shows maintenance code "M07" and the signal is transmitted to the external output (CnT-5).

- (a) Receipt of the signal by the external output is indicated by lighting an LED or other prepared on site.
 - Cooling, Dry, Auto(Cooling) : Indoor air temperature = Set room temperature by remote control + Alarm temperature difference
 - Heating, Auto(Heating) : Indoor air temperature = Set room temperature by remote control - Alarm temperature difference

Alarm temperature difference is selectable between 5 to 10°C.
- (b) If the following condition is satisfied or unit is stopped, the signal is disappeared.
 - Cooling, Dry, Auto(Cooling) : Indoor air temperature = Set room temperature + Alarm temperature difference -2°C
 - Heating, Auto(Heating) : Indoor air temperature = Set room temperature - Alarm temperature difference +2°C

(35) Peak-cut timer (RC-EX3 only)

Power consumption can be reduced by restricting the maximum capacity.

Set the [Start time], the [End time] and the capacity limit % (Peak-cut %).

- 4-operation patterns per day can be set at maximum.
- The setting time can be changed by 5-minutes interval.
- The selectable range of capacity limit % (Peak-cut %) is from 0% to 40-80% (20% interval).
- Holiday setting is available.

1.4 Operation control function by the outdoor control

(A) Normal control

(1) Operation of major functional components under each operation mode

Functional Components \ Operation mode	Cooling		Fan	Heating			Dehumidify
	Thermostat ON	Thermostat OFF		Thermostat ON	Thermostat OFF	Defrost	
Indoor unit fan	Remote control command	Remote control command	Remote control command	Remote control command	Intermittent operation	○ → ×	○ / ×
Indoor unit electronic expansion valve	Superheating control response	Fully closed	Fully closed	Outlet temperature control response	Slight opening control	Model-specific aperture opening angle	Superheating Control Response
Compressor [CM1]	○	×	×	○	×	○	○ / ×
Magnetic contactor CM1 [52X1]	○	○	× / ○	○	○	○	○
Compressor [CM2]	○ / ×	×	×	○ / ×	×	○	○ / ×
Magnetic contactor CM2 [52X2]	○	○	×	○	○	○	○
Outdoor unit fan [FMo-1]	○ / ×	×	× / ○	○ / ×	×	○ → ×	○ / ×
Outdoor unit fan [FMo-2]	○	×	× / ○	○	×	○ → ×	○
Inverter cooling fan [FMC1, 2]	○ / ×	○ / ×	×	○ / ×	○ / ×	○ / ×	○ / ×
4-way valve [20S1, SL, S3]	Refer to following table.						
Electronic expansion valve for heating [EEVH1, 2, 3]							
Electronic expansion valve for sub-cooling [EEVSC]							
Solenoid valve [SV1]	○ / ×	×	×	○ / ×	×	○ / ×	○ / ×
Solenoid valve [SV2]	○ / ×	×	×	○ / ×	×	○ / ×	○ / ×
Solenoid valve [SV6] [SV7]	○ / ×	×	×	○ / ×	×	○ / ×	○ / ×
Solenoid valve [SV11]	×	×	×	○ / ×	×	×	×
Solenoid valve [20UF]	○ / ×	×	×	○ / ×	○ / ×	○ / ×	○ / ×
Crankcase heater [CH1,2]	○ / ×	○ / ×	○ / ×	○ / ×	○ / ×	○ / ×	○ / ×

Notes(1) ○ : ON, × : OFF, ○/×, ×/○: ON or OFF

- 4-way valve (20S1, SL, S3), heating expansion valve (EEVH1, 2, 3) and sub-cooling expansion valve (EEVSC) operating pattern
The operating pattern for outdoor unit is determined from the run/stop signals, cooling/heating signals and indoor unit model capacity from the indoor units.

Note (1) Switching of the operating pattern is controlled by the capacity of indoor units which have their thermostat ON and the pressure sensors (PSH, PSL).

Operation pattern		Outdoor unit heat exchanger			Used for heat exchanger	4-way valve			Electronic expansion valve			
No.	Code	Heat exchanger 1	Heat exchanger 3	Heat exchanger 2		20S1	20S3	20SL	EEVH1	EEVH3	EEVH2	EEVSC
17	C8	COND	COND	COND	COND 100%	×	×	×	Fully open	Fully open	Fully open	PI control
13	C4	COND	COND	—	COND 50%	×	×	○	470-60	470-60	Fully closed	PI control
11	C2	COND	—	—	COND 40%	×	○	○	470-60	Fully closed	Fully closed	PI control
10	C1	—	COND	—	COND 10%	○	×	○	Fully closed	470-60	Fully closed	PI control
9	C0	—	—	—	COND 0%	○	○	○	Fully closed	Fully closed	Fully closed	Fully closed
8	E1	—	EVA	—	EVA 10%	○	○	○	Fully closed	PI control	Fully closed	Fully closed
5	E4	EVA	—	—	EVA 40%	○	○	○	PI control	Fully closed	Fully closed	Fully closed
5	E4	EVA	EVA	—	EVA 50%	○	○	○	PI control	PI control	Fully closed	Fully closed
1	E8	EVA	EVA	EVA	EVA 100%	○	○	○	PI control	PI control	PI control	Fully closed

Note (1) ○ : ON, × : OFF

(2) COND : Condenser, EVA : Evaporator

ESP-FP-2100 

(2) Compressor control (Master unit/slave unit)

(a) Starting compressor

(i) Compressor starting order

After turning the power on, firstly CM1 compressor starts. (In case of the combination use, it is CM01 of master unit)
 And corresponding to the condition of under-dome temperature and to the required capacity of indoor units thermostat ON, the next compressor will start sequentially, and finally maximum 6 compressors (in case of 3 outdoor units combination use) will start simultaneously.

Note (1) The speed marked * is determined depending on the above upper limit speed condition. If the condition is not established, it is 140rps → 120rps (excluding model 335).

1) Single use (Models 224, 280, 335)



Range of the compressor operation speed relative to load is as follows.

System load range (Number of operating outdoor units)	Compression [CC]	0	1
Local load range (Number of compressors operating in outdoor units)		0	1
CM1	50	0rps	20–140rps*

2) Single use (Models 400, 450)



Range of the compressor operation frequency relative to load is as follows.

System load range	Compression [CC]	0	1
Local load range		0	1
CM1	85	0rps	20–120rps

3) Single use (Models 475, 500, 560, 615, 670 : 2 compressors specification)

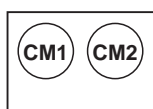

Range of the compressor operation frequency relative to load is as follows.

System load range	Compression [CC]	0	1	
Local load range		0	1	2
CM1	50	0rps	20–112rps	31–140rps*
CM2	50	0rps	0rps	31–140rps*

4) 2 outdoor units combination use (Models High-COP 450, 500, 560, 615, 670)

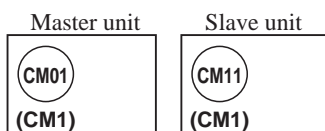

Range of the compressor operation frequency relative to load is as follows. Following table is applicable when CM01 starts initially.

System load range	Compression [CC]	0	1	1	
Local load range		0	1	1	
Master unit	CM01	50	0rps	20–112rps	31–140rps*
Slave unit	CM11	50	0rps	0rps	31–140rps*

5) 2 outdoor units combination use (Model 735)

Model 400 (Master) + 335 (Slave)

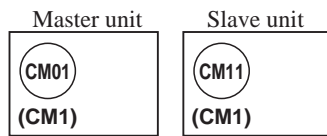

Range of the compressor operation speed relative to load is as follows. Following table is applicable when CM01 starts initially.

System load range		Compression [CC]	0	1	2
Local load range			0	1	1
Master unit	CM01	85	0rps	21-65rps	31-82rps
Slave unit	CM11	50	0rps	0rps	52-140rps*

Model 335 (Master) + 400 (Slave)

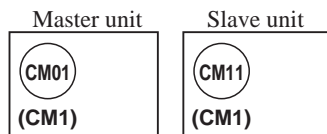

Range of the compressor operation speed relative to load is as follows. Following table is applicable when CM01 starts initially.

System load range		Compression [CC]	0	1	2
Local load range			0	1	1
Master unit	CM01	50	0rps	20-112rps	52-140rps*
Slave unit	CM11	85	0rps	0rps	31-82rps

6) 2 outdoor units combination use (Models 800, 850, 900)

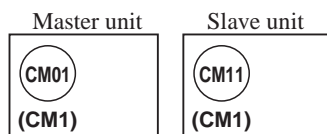

Range of the compressor operation speed relative to load is as follows. Following table is applicable when CM01 starts initially.

System load range		Compression [CC]	0	1	2
Local load range			0	1	1
Master unit	CM01	85	0rps	20-65rps	31-120rps
Slave unit	CM11	85	0rps	0rps	31-120rps

7) 2 outdoor units combination use (Models 950, 1000, 1060, 1120)

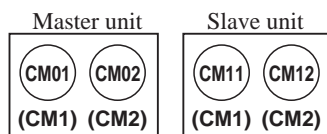

Range of the compressor operation speed relative to load is as follows. Following table is applicable when CM01 starts initially.

System load range		Compression [CC]	0	1	2	
Local load range			0	1	1	2
Master unit	CM01	50	0rps	20-112rps	31-112rps	31-140rps*
	CM02	50	0rps	0rps	0rps	31-140rps*
Slave unit	CM11	50	0rps	0rps	31-112rps	31-140rps*
	CM12	50	0rps	0rps	0rps	31-140rps*

8) 3 outdoor units combination use (Models High-COP 735, 800, 850, 900, 950, 1000)

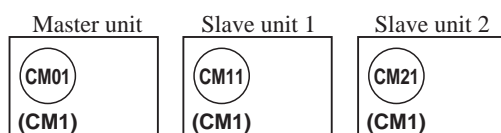

Range of the compressor operation speed relative to load is as follows. Following table is applicable when CM01 starts initially.

System load range		Compression [CC]	0	1	2	3
Local load range			0	1	1	1
Master unit	CM01	50	0rps	20-112rps	31-112rps	31-140rps*
Slave unit 1	CM11	50	0rps	0rps	31-112rps	31-140rps*
Slave unit 2	CM21	50	0rps	-112rps	31-112rps	31-140rps*

9) 3 outdoor units combination use (Models 1200, 1250, 1300, 1350)

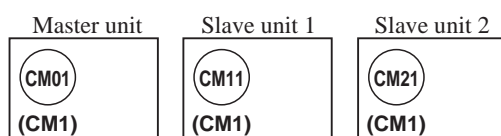

Range of the compressor operation speed relative to load is as follows. Following table is applicable when CM01 starts initially.

System load range		Compression [CC]	0	1	2	3
Local load range			0	1	1	1
Master unit	CM01	85	0rps	20-65rps	31-65rps	31-120rps
Slave unit 1	CM11	85	0rps	0rps	31-65rps	31-120rps
Slave unit 2	CM21	85	0rps	0rps	0rps	31-120rps

10) 3 outdoor units combination use (Models 1425, 1450, 1500, 1560, 1620, 1680)

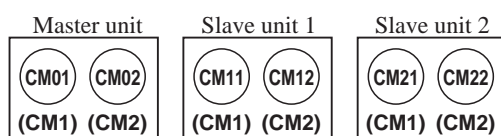

Range of the compressor operation speed relative to load is as follows. Following table is applicable when CM01 starts initially.

System load range		Compression [CC]	0	1	2	3	
Local load range			0	0	1	1	2
Master unit	CM01	50	0rps	20-112rps	31-112rps	31-112rps	31-140rps*
	CM02	50	0rps	0rps	0rps	0rps	31-140rps*
Slave unit 1	CM11	50	0rps	0rps	31-112rps	31-112rps	31-140rps*
	CM12	50	0rps	0rps	0rps	0rps	31-140rps*
Slave unit 2	CM21	50	0rps	0rps	0rps	31-112rps	31-140rps*
	CM22	50	0rps	0rps	0rps	0rps	31-140rps*

(ii) Rotation of compressor start/stop order

- 1) The compressors will be changed over by determining the start/stop order in each heat load zone.
- 2) In case of single use, the starting order of CM1 and CM2 will be changed over on each occasion when the outdoor unit stops.
- 3) In case of combination use, the starting order of CM01(CM11) [CM21] and CM02(CM12) [CM22] will be changed over on each occasion when the master unit or slave unit stops all independently.
- 4) In case of combination use, the starting order of master and slave units will be changed over on each occasion when the master unit or slave unit stops all independently.

Starting order of outdoor units Master→Slave→Master

(3) Outdoor fan control (Master unit/slave unit)**(a) Outdoor fan speed and fan motor rotation speed**Unit : min⁻¹

Fan tap	Cooling		Heating		Remarks"
	FMo1	FMo2	FMo1	FMo2	
0th speed	0	0	0	0	stop
1st speed	0	160	0	160	Min. speed at 1 FM operation
2nd speed	200	200	0	400	Max. speed at 1 FM operation (During heating)
3rd speed	300	300	160	160	Min. speed at 2 FM operation (During heating)
4th speed	400	400	1140	1140	Max. speed at 2 FM operation (During heating) Rated speed of heating
5th speed	500	500	–	–	
6th speed	600	600	–	–	
7th speed	700	700	–	–	
8th speed	800	800	–	–	
9th speed	900	900	–	–	
10th speed	1000	1000	–	–	
11th speed	1100	1100	–	–	
12th speed	1180	1180	–	–	Rated speed of cooling

(b) Outdoor fan control in cooling mode

Fan speed is controlled based on the high pressure during cooling/dehumidifying (detected with PSH) and the outdoor air temperature (detected with Tho-A).

- (i) Initial fan speed is as follows.

Initial cooling speed of outdoor fan

Outdoor temperature $\leq 10^{\circ}\text{C}$	$10^{\circ}\text{C} \leq$ Outdoor temperature $< 15^{\circ}\text{C}$	$15^{\circ}\text{C} \leq$ Outdoor temperature
2nd speed	4th speed	6th speed

- (ii) Speed changes depending on high pressure values.

(c) Outdoor fan control in heating mode

Fan speed is controlled based on the low pressure (detected with PSL) during heating operation.

- (i) Speed changes depending on low pressure values.
(ii) Under normal condition, the stepless fan control between 1st speed and 4th speed is performed.

(4) Oil return control

When the accumulated system operation has elapsed 2 hours during the initial operation after the power on, the oil return control is performed once in every 5 hours or when the quantity of oil loss has reached the setting value.

(a) Control contents

- (i) During the cooling or heating operation, the oil return control is performed on the units on which the THERMOSTAT OFF, FAN OFF or ANOMALY STOP has occurred.
(ii) Indoor unit is stopped during the oil return control.

(b) Ending conditions

The control is terminated with one of following conditions is satisfied.

- (i) When the operation has continued for 5 minutes after the release of oil return operation frequency command.
(ii) When it has not reached the compressor operation frequency at 2 minutes after the start of all compressors following the 3 minutes delay, the oil return control is terminated. When it has not yet reached the operation frequency, however, the oil return control is performed once more one hour later.
(iii) Even when it has reached the compressor operation frequency at 2 minutes after the start of compressor following the 3 minutes delay, if the compressor operation frequency has gone below the oil return operation frequency before the normal termination of oil return control, the oil return control is terminated. When it cannot maintain the operation frequency, however, the oil return is performed once more one or two hours later.
(iv) When the pump down control and the measurement mode.

(5) Defrost operation (Master unit/Slave unit)

If the defrost operation starting conditions at the outdoor heat exchanger are satisfied, defrost operation starts.

(a) Temperature conditions for defrost operation

(i) Conditions for starting defrost operation

When all of following conditions are satisfied, defrost operation will be started.

- 1) When the cumulative operation time of the compressor becomes 33 minutes after completion of previous defrost operation, or it becomes 33 minutes after heating operation starts.
- 2) When 8 minutes have elapsed after one compressor is turned ON from the state of all compressors OFF.
- 3) When 8 minutes have elapsed after one outdoor fan is turned ON from the state of all outdoor fan OFF.

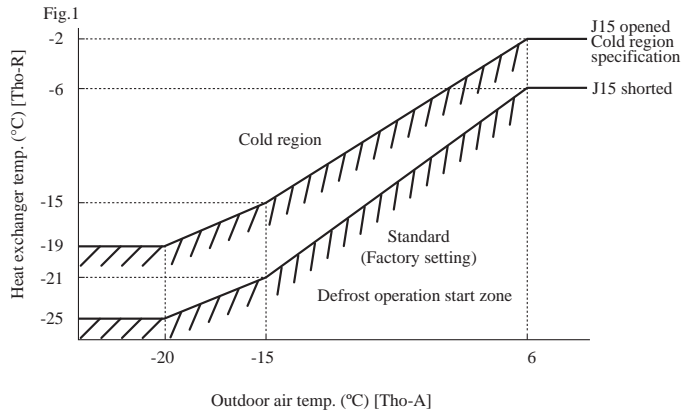

- 4) When either of following conditions is satisfied after all of the above conditions are satisfied.

- When the temperatures detected with the outdoor heat exchanger temperature thermistors (Tho-R1,-R2) and outdoor air temperature thermistor (Tho-A) are below the defrost starting temperature mentioned in the above graph continuously for 3 minutes.
- When the suction pressure saturation temperature has continued for 3 minutes in the defrost zone which is determined by the outdoor air temperature sensor (Fig. 2)

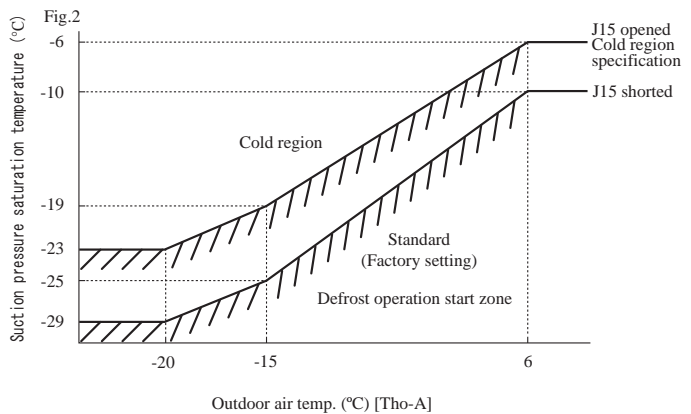

(ii) Conditions for finishing defrost operation

- Standard (J14 is shorted)
 - 1) When the temperature detected with both outdoor heat exchanger temperature thermistors (Tho-R1 and Tho-R2) is higher than 9°C
 - 2) Or when 12 minutes have elapsed since defrost operation started.
- Cold region setting (J14 is open)
 - 1) When (Tho-R1 and Tho-R2) $\geq 9^\circ\text{C}$ is satisfied, after 2 minutes and 30 seconds have elapsed since defrost operation started, and when either of following conditions is satisfied, the heating operation starts.
 - a) 2 minutes and 30 seconds have elapsed since the temperature of either Tho-R1 or Tho-R2 was 14°C or higher
 - b) The temperature of either Tho-R1 or Tho-R2 is 30°C or higher.
 - c) 14 minutes have elapsed since defrost operation started.
 - 2) When (Tho-R1 and Tho-R2) $< 9^\circ\text{C}$ is satisfied, after 2 minutes and 30 seconds have elapsed since defrost operation started, and when either of following conditions is satisfied, the heating operation starts.
 - a) 5 minutes have elapsed since the temperature of either Tho-R1 or Tho-R2 was 14°C or higher.
 - b) The temperature of either Tho-R1 or Tho-R2 is 30°C or higher.
 - c) 14 minutes have elapsed since defrost operation started.

(6) Protective control

(a) High pressure protective control/error

If the high pressure exceeds 3.7 MPa, the compressor speed is reduced gradually.

It reduces to 20 rps at the lowest.

If the high pressure still rises to 4.15 MPa, the compressor stops.

(b) Low pressure protective control/error

If the low pressure drops below 0.18 MPa, the compressor speed is reduced gradually.

It reduces to 20 rps at the lowest.

If the low pressure still drops below 0.134 MPa, the compressor stops.

(c) Discharge pipe temperature control/error

If discharge pipe temperatures (detected with Tho-D 1, -D2) exceed 120°C, the compressor speed is reduced gradually. (To 20 rps at the lowest) If the temperatures still continue to rise beyond 130°C, the compressor stops.

(d) Compressor compression ratio protective control

If the compressor compression ratio exceeds the setting value, the compressor speed is reduced gradually.

It reduces to 20 rps at the lowest.

(e) Current safe control

(i) The current safe control monitors current values at T-phase of inverter. If the value exceeds the setting value, the compressor speed is reduced.

If the value is higher than the setting value even if the speed is reduced, the speed is reduced further.

(ii) This control is reset if the current value at T-phase of inverter becomes lower than the setting value – 1 A for 3 minutes continuously or lower than the setting value for 6 minutes continuously.

(f) Current cut control

(i) Current sensor built in the power transistor monitors current values output from the inverter. If the value exceeds 88 A, the current cut control stops the compressor. The compressor starts automatically 3 minutes after the stop.

(ii) If the above control activates 4 times within 15 minutes, 52C1 or 52C2 is turned off, and the operation is stopped with the error stop.

State of the error continues for 3 minutes after the error stop. The error can be reset by operating the inspection reset from the remote control.

(g) Power transistor temperature (PT) protective control

If temperatures on the power transistor exceed the setting value, the compressor speed is reduced gradually.

It reduces to 20 rps at the lowest.

(h) Under-dome temperature protective control

If the under-dome temperature exceeds the setting value, the compressor speed is reduced gradually.

It reduces to 20 rps at the lowest.

(i) Protection for combination of outdoor units (Master unit)

The capacity of connectable outdoor units is checked when the communication check is performed after turning the power ON.

If the checked result is other than the allowable combinations mentioned in the following table ① it is prohibited to start operation due to outdoor unit combination error.

When this error occurs, the error code mentioned in the following table ② is displayed on the 7-segment display.

Table① combination list

Capacity	Combination patterns
615	Combination (280+335)
670	Combination (335+335)
735	Combination (335+400)
800	Combination (400+400)
850	Combination (400+450)
900	Combination (450+450)
950	Combination (475+475)
1000	Combination (500+500)
1060	Combination (500+560)
1120	Combination (560+560)

High-COP combination

Capacity	Combination patterns
1200	Combination (400+400+400)
1250	Combination (400+400+450)
1300	Combination (400+450+450)
1350	Combination (450+450+450)
1425	Combination (475+475+475)
1450	Combination (475+475+500)
1500	Combination (500+500+500)
1560	Combination (500+500+560)
1620	Combination (500+560+560)
1680	Combination (560+560+560)

Capacity	Combination patterns
450	Combination (224+224)
500	Combination (224+280)
560	Combination (280+280)
615	Combination (280+335)
670	Combination (335+335)
735	Combination (224+280+280)
800	Combination (280+280+280)
850	Combination (280+280+335)
900	Combination (280+335+335)
950	Combination (335+335+335)

Table② Contents displayed on 7-segment display at the combination error

Code display area	Data display area	Contents of invalid operation
OPE	3	Invalid combination of outdoor units

(7) Auto backup operation**(a) Classification of auto backup operations**

When the auto backup operation is enabled, anomaly stops are classified as follows and countermeasures are provided for respective categories.

System stop: All stop including master/slave units

Unit stop: Stop in the unit of outdoor unit

Compressor stop: Stop in the unit of compressor

(b) Control contents of auto backup operation

- (i) Condition of auto backup operation is established when the dip switch SW3-2 on the PCB of master unit is turned ON (selected).
- (ii) However, the switching of SW3-2 is effective only at the power on. (It does not become effective unless the power source is reset.)
- (iii) Anomaly contents in the following table are invalid and are not detected when the auto backup is effective.

Anomaly detection invalid code	SW3-2ON	Anomaly detection invalid code	SW3-2ON
E32: Open L3 phase on power source at primary side	○	E45: Communication error between inverter PCB and outdoor control PCB	○
E36: Discharge pipe temperature error	○	E48: Outdoor DC fan motor anomaly	○
E37: Outdoor heat exchanger and sub-cooling coil temperature thermistor anomaly	○	E51: Power transistor overheat (Continuousness)	○
E38: Outdoor air temperature thermistor anomaly	○	E53: Suction pipe temperature thermistor anomaly	○
E39: Discharge pipe temperature thermistor anomaly	○	E55: Under-dome temperature thermistor anomaly	○
E40: High pressure anomaly	○	E56: Power transistor temperature thermistor anomaly	○
E41: Power transistor overheat	○	E58: Anomalous compressor by loss synchronism	○
E42: Current cut	○	E59: Compressor startup failure	○
E44: Liquid flooding anomaly	○	E60: Rotor position detection failure	○

- (iv) If any anomaly occurs when the auto backup is effective, the operation output (CnH), Anomaly output (CnY), 7-segment display and LED show as follows.
 - 1) At the system stop

Operation output on the master unit is turned OFF, the Anomaly output is turned ON, 7-segment display and LED show the anomaly, and the remote control displays E??. (To reset the anomaly, it is necessary to reset the inspection from the remote control.)
 - 2) At the unit stop

On the anomaly occurred unit only, the operation output is turned OFF, the Anomaly output is turned ON, 7-segment display and LED show the anomaly and normal units continue their operation ON(or stop).
To reset the state of anomaly on the unit the anomaly occurred, it depends on the condition to reset the state of each anomaly.
 - 3) At the compressor stop

Only the compressor concerned stops, previous states are maintained on the operation output, anomaly output, 7-segment display and LED. To reset the state of anomaly on the compressor, it depends on the condition to reset the state of each anomaly.

Remote control error display	Anomaly contents	Anomalous stop of master outdoor unit			Anomalous stop of slave outdoor unit		
		System stop	Unit stop	Compressor stop	System stop	Unit stop	Compressor stop
E31	Duplicated outdoor unit address No.	○					
E32	Open L3 Phase on power source at primary side		○			○	
E36	Discharge pipe temperature error			○			○
E37	Outdoor heat exchanger and subcooling coil temperature thermistor anomaly		○			○	
E38	Outdoor air temperature thermistor anomaly		○			○	
E39	Discharge pipe temperature thermistor anomaly			○			○
E40	High pressure anomaly		○			○	
E41	Power transistor overheat			○			○
E42	Current cut			○			○
E43	Excessive number of indoor unit connected, excessive to tal capacity of connection	○			—	—	—
E44	Liquid flooding anomaly			○			○
E45	Communication error between inverter PCB and outdoor control PCB		○			○	
E48	Outdoor DC fan motor anomaly		○			○	
E49	Low pressure error	○			○		
E51	Power transistor overheat (continuousness)			○			○
E53	Suction pipe temperature thermistor anomaly		○			○	
E54	High pressure sensor/Low pressure sensor anomaly	○			○		
E55	Under-dome temperature thermistor anomaly			○			○
E56	Power transistor temperature thermistor anomaly			○			○
E59	Compressor startup failure			○			○
E61	Communications error between the master unit and slave units	○			—	—	—
E63	Emergency stop	○			○		

(c) Prohibiting conditions of auto backup operation

- (i) When the conditions of oil return control are not established
- (ii) When the backup operation time has exceeded the limit value

(d) Control after the conditions to prohibit the auto backup operation have been established

All compressor stop, and the error display [EXX] is shown on the 7-segment display and the remote control.

In this state, the inspection reset of remote control is effective. → [EXX] is displayed continuously on the remote control.

Backup operation function is only for emergency purpose when one of compressors or one of units is damaged. If backup operation is performed continuously for long period, it may cause the damage of good compressors. Accordingly be sure to repair the damaged unit or to replace the damaged compressor and to cancel the backup operation within 48 hours after starting backup operation.

(8) Test run**(a) This control can be performed from the master unit, not from the slave unit.**

If this control is done from the slave unit, the following display is shown on the 7-segment display.

The display returns to normal display if the test run control switch is reset.

Code indicator	Data indicator	Contents of invalid operation
OPE	10	Slave setting is invalid.

(b) Test run from master outdoor units with dip switches SW5-1 and SW5-2.

SW5-1	ON	SW5-2	OFF	Test run for heating
			ON	Test run for cooling
OFF	Normally operation and after test operation			

Take note that this operation has priority over other option devices such as central control and etc.

This operation status is transmitted to the option devices.

(Note) Test run operation by external input is also available with following method. (Refer next page for detail)

- Select the external input terminal (CnS1) and set 7-segment [P11]-[6] for the function of SW5-1, and select the external input terminal (CnS2) and set 7-segment [P12]-[7] for the function of SW5-2.

CnS1	Shorted	CnS2	Open	Test run for heating
			Shorted	Test run for cooling
Open	Normal operation and after test operation			

- Other combination of external input terminals (CnS1, CnS2, CnG1, CnG2) and of setting function with 7-segment ([P11], [P12], [P13], [P14] and -[6], -[7]) are available to use.

(c) Starting conditions of test run operation

- Dip switch SW5-1 is turned ON. However the input before the power ON is invalid.
- The dip switches SW3 and SW5, other than SW5-1 and SW5-2, should be turned OFF.
However, regarding the dip switch SW3-2 for automatic backup operation, it is invalid during test run operation regardless whether SW3-2 is turned ON (valid) or OFF (invalid).→In order to check trouble during test run operation.

(d) Control during test run (If indoor units are normal)

- Heating operation is performed with SW5-2 OFF, while cooling operation is performed with SW5-2 ON.
- Indoor EEV control at the end of test run is depended on the specifications of the indoor unit.
- Cooling operation: Compressor frequency control is depended on the cooling low pressure control.
- Heating operation: Compressor frequency control is depended on the heating high pressure control.

(e) Ending conditions of test run operation

Test run operation is terminated if one of following conditions is satisfied.

- Test run operation ends when the dip switch SW5-1 is turned OFF.
- When the operation is stopped by the error control during test run, the error is displayed same as the normal operation and the state of error stop is retained even if SW5-1 is turned OFF.

(9) Branching control

Switching between high and low-pressure gas pipes is performed by branching control when indoor units start operation, or if indoor units are switched between cooling and heating. The indoor unit controls branching control directly by use of CnT2 output from the indoor control board. The following operations are performed during switching between high and low-pressure gas pipes to prevent noise when switching and protect the compressor.

- (a) The compressor speed might drop.**
- (b) Air flow rate of indoor units might change when switching units between cooling and heating depending on the settings.**
- (c) Fans of indoor units might stop if the units are started in cooling.**

(10) Priority Operation of Maximum Coefficient of Performance

Priority operation of maximum coefficient of performance, which prevents compressor disabling, starts when all of the following conditions are satisfied.

- (a) Difference between the cooling and heating thermostat-ON capacities is within +5%**
- (b) Operating capacity of indoor units is 95 to 105%**
- (c) Outdoor temperature is 14 to 18 °C**
- (d) Inlet temperature of all indoor units is 20 to 27 °C**
- (e) Single operation**
- (f) All of the above conditions are satisfied continuously for 30 minutes**

(B) Option controls

• External input terminal

- ① 4 external input terminals (CnS1, CnS2, CnG1 and CnG2) are provided. (See Fig-1)
- ② Each external input terminal can be changed its function by allotting the external input function No. of P07-P10 selected with 7-segment respectively. (External input functions of the code P07-P10 are shown in Fig-2)

External input terminal			External input function allotment of 7-segment		
Terminal	Specification	Factory setting	Code	Function No.	Factory setting
CnS1	No voltage contact (DC12V)	Shorted	P07	"0"- "9"	"0"
CnS2	No voltage contact (DC12V)	Shorted	P08	"0"- "9"	"1"
CnG1	No voltage contact (DC12V)	Open	P09	"0"- "9"	"2"
CnG2	No voltage contact (DC12V)	Open	P10	"0"- "9"	"3"

Fig-1

- ③ The following function is effective, when the external input function of PXX-"X" is allotted and the signal is input to the external terminal of CnXX.

(Example) If CnS1 terminal is used for demand control (pulse input), allot the "1" of P07 and open J13, and if CnS2 terminal is used for demand control (level input), allot the "1" of P08 and short J13.

By changing the allocation of external input function (P07-10) on the 7-segment, functions of external input terminal may be selected. Inputting signals to external input terminals enable the following functions.

Setting value for external input function assignment	External input terminal shorted	External input terminal open
"0" : External operation input	Permitted	Prohibited
"1" : Demand input	*3	*3
"2" : Cooling / heating force input	Heating	Cooling
"3" : Silent mode 1 *1	Valid	Invalid
"4" : Spare		
"5" : Outdoor fan snow control input	Valid	Invalid
"6" : Test run external input 1 (SW5-1 equivalent)	Test run start	Normal
"7" : Test run external input (SW5-2 equivalent)	Cooling	Heating
"8" : Silent mode 2 *1	Valid	Invalid
"9" : Demand input	*3	*3
"10" : AF periodic inspection display	Valid	Invalid
"11" : AF error display	Valid	Invalid
"12" : Building multi energy save control	Valid	Invalid

*3 Demand setting table

Demand control	Function assignment 1	Function assignment 9
None (Normal)	Shorted	Shorted
1-step	Open	Shorted
2-step	Open	Open
3-step	Shorted	Open

*1 Valid/invalid is changed depending on outdoor temperatures.
 *2 It is always Valid, regardless of outdoor temperature.
 *3 According to the demand setting table.

Fig-2

- ④ J13: Switching of CnS1,S2 input method (CnS1, S2 only)

J13 shorted: Level input by CnS1, S2
 J13 open : Pulse input by CnS1, S2

*1 "Setting" means;

Master : Set only the master unit. (No necessary to set the slave unit)
 Master/Slave: Set both master/slave unit same.

(1) External input and demand input (Master unit/Slave unit)

(a) Operation permission or prohibition mode

(Note) Following explanation is based on using CnS1 terminal and setting function [P07]-[0] with 7-segment display.

However other terminals can be used with following function setting of 7-segment display.

CnS2: [P08]-[0] CnG1: [P09]-[0] CnG2: [P10]-[0]

- 1) Operation permission or prohibition mode is switched with the connector (CnS1) and the Jumper wire (J13) on the outdoor control PCB after setting function [P07]-[0] (Factory setting) with 7-segment display
- 2) Operation permission/prohibition control by the external input CnS1 to outdoor unit.

Input: CnS1	Switching CnS1 input method:J13	CnS1: Switching operation permission/prohibition mode
	Shorted (Level input)	Operation prohibition mode → Operation permission mode
	Open (Pulse input)	Switching operation permission/ Operation prohibition mode (Reversal)
	Shorted (Level input)	Operation permission mode → Operation prohibition mode
	Open (Pulse input)	— (NOP)

Note (1) Factory setting J13: Shorted, CnS1: Shorted (Short pin is connected)

- 3) The operation condition is displayed on the LCD of remote control and it is transferred to option central control.
- 4) When the operation command from remote control is not accepted by this control, "Center" is displayed on the LCD of remote control. (See item 5 mentioned next page.)
- 5) CnS1 performs the following operation according to switching the jumper wire (J13) shorted or open. In case of pulse input, the pulse width is 500ms or larger.

① J13 – Shorted

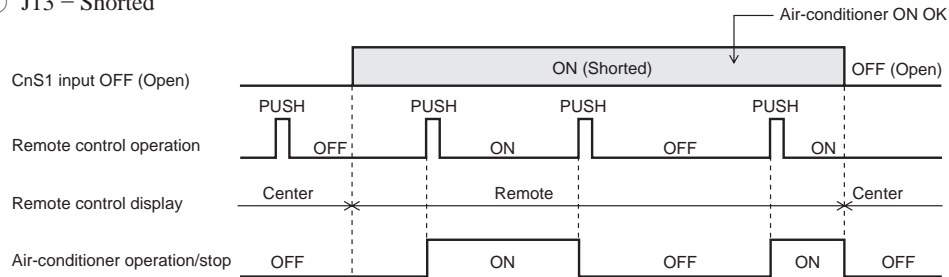

② J13 - Open

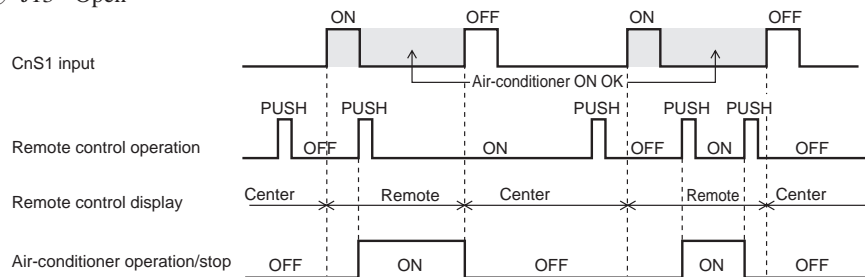

- 6) After changing mode from operation prohibition mode to permission mode, the indoor units operation status can be select by 7-segment [P17] setting.
 7-segment [P17] =0 → Keeping STOP
 7-segment [P17] =1 → Automatically RUN

(b) Demand control

(Note) Following explanation is based on using CnS2 terminal and setting function [P08]-[1] with 7-segment display.

However other terminals can be used with following function setting of 7-segment display

CnS1: [P07]-[1] CnG1: [P09]-[1] CnG2: [P10]-[1]

- 1) Demand control or normal control is switched with the connector (CnS2) and the jumper wire (J13) on the outdoor control PCB after setting function [P08]-[1] (Factory setting) with 7-segment display.

J13: Switching of CnS2 input method

J13 shorted: Level input by CnS2

J13 open : Pulse input by CnS2

- 2) Demand control/Normal operation by the external input CnS2 to outdoor unit.

Input: CnS2	Switching CnS2 input method:J13	CnS2: Switching operation permission/prohibition mode
	Shorted (Level input)	Demand control → Normal operation
	Open (Pulse input)	Switching demand control/ Normal operation (Reversal)
	Shorted (Level input)	Normal control → Demand operation
	Open (Pulse input)	(NOP)

Note (1) Factory setting J13: Shorted, CnS2: Shorted (Short pin is connected)

- 3) The operation condition is displayed on the LCD of remote control and it is transferred to option central control.

4) Demand control

Demand ratio can be changed with the 7-segment "P04" on the outdoor control PCB.

P04 setting	Compressor output (%)
080(Factory default)	80
060	60
040	40
000	0

5) This control has priority over the controls of 4-way valve safeguard, compressor protective start operation, defrost operation, oil equalized operation, oil return operation, pump-down operation for replacement, Start/Stop pump-down operation and check operation.

6) CnS2 performs the following operation according to switching the jumper wire (J13) shorted or open.

In case of pulse input, the pulse width is 500ms or larger.

① J13 – Shorted

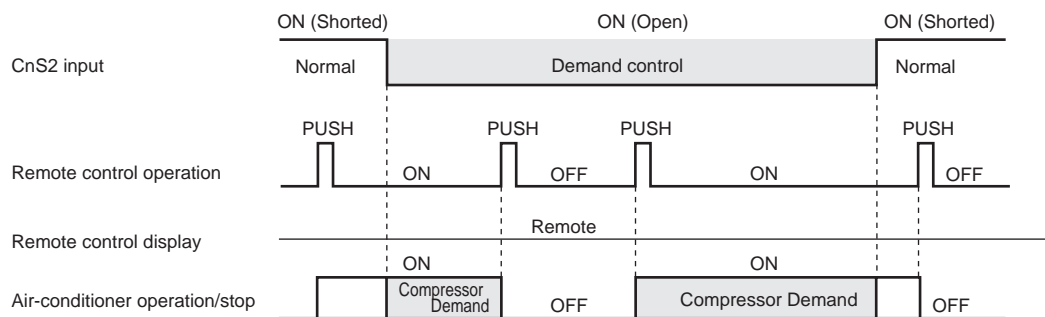

② J13 - Open

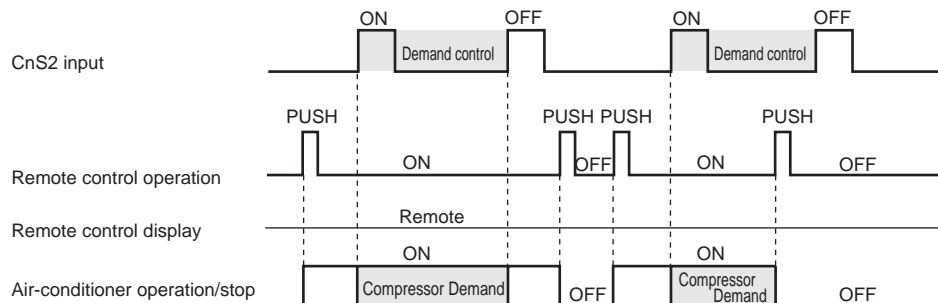

(c) 3 step demand control

1) Starting condition

When the "Demand input 2" via the external input terminal of outdoor unit (master unit) has become valid.

2) Contents of control

The demand control is performed at the demand rate which has been set with [P14] and [P15] according to the demand input or the demand input 2.

Demand control	Following is assigned to one of P07 - P10.		Demand rate setting
	Demand input (Function assignment: 1)	Demand input 2 (Function assignment: 9)	
None (Normal)	Shorted	Shorted	—
1st step demand	Open	Shorted	P04
2nd step demand	Open	Open	P14
3rd step demand	Shorted	Open	P15

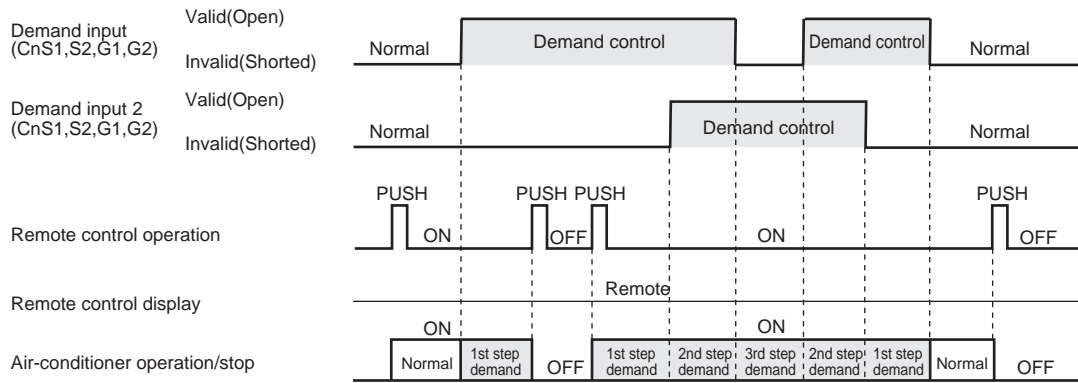

3) Ending condition

When the starting conditions have been lost.

(d) Demand control from indoor unit

1) Starting condition

- ① When a demand ratio (“80%”, “60%”, “40%” or “0%”) has been transmitted from an indoor unit of “Peak-cut timer” function.
- ② Normal demand of Item (b) is not activated.
- ③ This control is performed on the RC-EX3 remote control.

2) Contents of control

- ① Compressor’s upper limit speed is restricted according to the demand restriction rate.
- ② The demand ratio controlled by the restriction rate which is transmitted from an indoor unit.
- ③ If the demand control rate signals are received from two or more indoor units, the control takes the lowest rate.
- ④ When the demand rate is other than 0%, this control is superseded by the controls of 4-way valve safeguard, de-frost operation, oil return operation, oil equalized operation, pump-down operation for replacement, Start/Stop pump-down operation and check operation.

3) Ending condition

When the starting conditions have been lost.

(2) Silent mode control

(Note) With CnG2 terminal and 7-segment display [P10]-[3] for silent mode 1(Factory default) or with CnG2 terminal and 7-segment display [P10]-[8] for silent mode 2 (Setting on site) It is also available to use other terminals as follows.

CnS2: [P08]-[3] or -[8] CnS1: [P07]-[3] or -[8] CnG1: [P09]-[3] or -[8]

- (a) Silent mode is commanded either from the indoor unit (remote control setting) or from the master outdoor unit (CnG2).
- (b) When the "Silent mode start" signals is received from one of indoor units, it enters the silent mode operation.
- (c) When CnG2 of master unit is shorted after setting function [P10]-[3] (Silent mode 1) or [P10]-[8] (Silent mode 2) with 7-segment display, it enters the silent mode operation. (If the signal is input to the slave unit, it is invalid)
- (Note) Silent mode 1 and 2 can not be set at same time
- (d) When the "Silent mode start" signal from indoor unit and the "Silent mode" signal from outdoor unit are received, it enters the silent mode operation under "or"condition.
- (e) When silent mode signals from all indoor units become "Silent mode end" and when silent mode signal input to CnG2 on outdoor unit becomes open, the silent mode operation is reset.
- (f) The operation of silent mode 1 is effective within the following temperature range.
- (Note) In case of external input of silent mode 2, following temperature conditions are disregarded.
- (i) Silent mode 0,1 : Effect on field A,B
- (ii) Silent mode 2,3 : Effect on field B

- (g) Silent mode setting
Silent mode setting can be changed with 7-segment "P05" on the outdoor control PCB.

P05 setting	Silent mode setting
000 (Factory default)	Silent mode setting 0
001	Silent mode setting 1
002	Silent mode setting 2
003	Silent mode setting 3

• Cooling

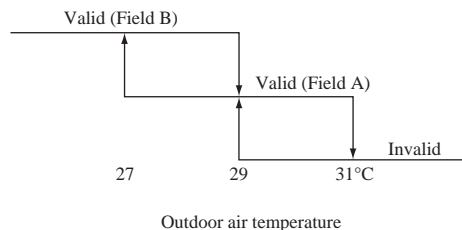

• Heating

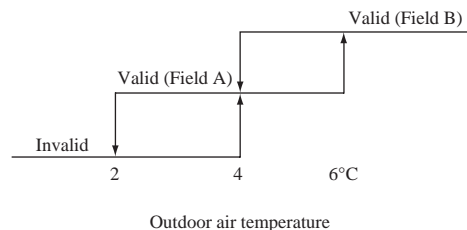

- (h) Sound level (Reference data)

Model	SPL Sound pressure level for cooling	SPL Sound pressure level for heating	SPL Silent mode setting 0	SPL Silent mode setting 1	SPL Silent mode setting 2	SPL Silent mode setting 3	PWL Cooling	PWL Heating
	dB(A)	dB(A)	dB(A)	dB(A)	dB(A)	dB(A)	dB(A)	dB(A)
FDC224KXZRE1	55	57	55	51	47	43	74	75
FDC280KXZRE1	55	57	55	51	47	43	75	76
FDC335KXZRE1	61	58	61	57	53	49	81	77
FDC400KXZRE1	60	62	60	56	52	48	81	83
FDC450KXZRE1	61	62	61	57	53	49	81	83
FDC475KXZRE1	61	62	61	57	53	49	81	82
FDC500KXZRE1	61	62	61	57	53	49	81	82
FDC560KXZRE1	64	65	64	60	56	52	84	85
FDC615KXZRE1	65	66	65	61	57	53	84	85
FDC680KXZRE1	65	66	65	61	57	53	84	85

(3) Outdoor fan snow protection control (Master unit/Slave unit)

(Note) Following explanation is based on setting function with 7-segment display [P02].

However the following terminals and 7-segment function settings are available to use.

CnS1: [P07]-[5] CnS2: [P08]-[5] CnG1: [P09]-[5] CnG2: [P10]-[5]

- (a) The setting of this control should be done not only on the master unit but also on the slave unit, because the fans of master unit and the slave unit are controlled independently.
- (b) The control is enabled /disabled by selecting [0] or [1] displayed at 7-segment LED of master/slave units.
- (c) Operation method of outdoor fan snow protection control
 - (i) Set the code [P02] on 7-segment display
 - (ii) “0” or “1” is displayed at the data display area of 7-segment LED.
 - “0”: Outdoor fan snow protection control is disabled. (Factory setting)
 - “1”: Outdoor fan snow protection control is enabled.
 - (iii) Press SW7 (Data write/delete) for 3 seconds continuously
 - (iv) “0” or “1” blinks every 0.5 second at the data display area of 7-segment LED.
 - (v) Press SW8 (one digit) to toggle the display between “0” and “1”.
 - (vi) If SW7 is pressed for 3 seconds continuously while “0” and “1” are blinking, “0” or “1” at the data display area of 7-segment LED stops blinking.

With this operation, the enabled/disabled setting of outdoor fan snow protection control is saved in the memory of EEPROM, and henceforth the outdoor fan is controlled according to the contents of memory.

- (vii) Contents of outdoor fan snow protection control are retained even if the power is turned off and backed on again.
- (d) Contents of outdoor fan snow protection control
 - (i) At the status of all stop or emergency stop, if the outdoor air temperature drops 3°C or lower, all of outdoor fans are operated at the maximum speed (4th speed) once every 10 minutes.
 - (ii) The outdoor fan runs for 30 minutes.
 - (iii) During this snow protection control, the magnetic contactor 52C1 of the compressor is ON.

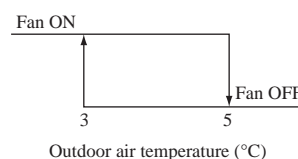

(4) Emergency stop control

When one of indoor units receives the emergency stop signal through CnT terminal on the indoor control PCB from the device like as refrigerant leakage detector and that information is transmitted to the outdoor unit, the outdoor unit stops operation and emergency stop error message transmitted to all indoor units running.

It is able to make the emergency stop function effective by remote control indoor function setting.

- (a) When the outdoor unit receives the “Emergency stop” command from the indoor unit, it makes all stop by error.
- (b) And the “Emergency stop” command is transmitted to all indoor units and error code “E63” is displayed.
- (c) When the outdoor unit receives the “Emergency stop reset” command from the indoor unit, the “Emergency stop reset” command is transmitted to all indoor units.

(5) Operation and error signal output (Master unit/Slave unit)

This is the function to retrieve and display the operation and error information on the outdoor unit as a batch. Although indoor units also have the function to retrieve the operation and error information, this function is designed to retrieve the whole information of each refrigeration system connected to the outdoor unit.

- (a) The terminals for the operation and error outputs at the outdoor unit side are provided on the outdoor control PCB.
- (b) Diagram of output relay operations

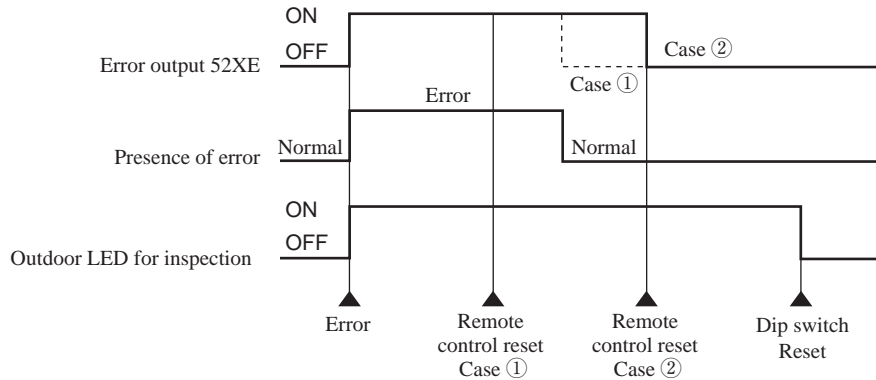

- (c) The error output relay (52XE) is turned ON when the error stop occurs, and is turned OFF when the error reset is done from remote control by pressing "Check" and "Reset" button simultaneously after recovery from the error (Remote control reset case ②).
Before recovery from the error, if the error reset is done from remote control, 52XE is not turned OFF, but it will be turned OFF automatically after the error is recovered subsequently (Remote control reset case ①).
- (d) If at least one of connected indoor units is operating, the operation output relay (52XR) is turned ON. (Operation means the state that remote control is turned ON, in which the fan operation and the thermostat OFF is included, but the error stop is excluded.)
- (e) Output relay (52XR, 52XE) of DC12V should be prepared in the field. The maximum load of relay is LY2F (Omron).
- (f) The output connectors (CnH, CnY) to be connected to the relays for operation output (52XR) and for error output (52XE) is mounted on the outdoor control PCB.
- (g) If CPU goes out of control, this function becomes disable.
- (h) When the automatic backup operation is effective, there is no error display for any error on the compressor stopping by detecting its anomaly.

(6) External output

This function is used in order to operate the external option devices in conjunction with relay output of the respective operational information from outdoor unit.

However, since these models do not have dedicated output, it makes switchable by using the existing 52R relay in order to comply with various usages.

This control is done for master unit and slave unit independently.

[External output function]

External output function of CnZ1 can be switched by changing of [P06] of 7-segment display from "0" to "5" as mentioned below. However in case of setting [P19] = 1 of 7-segment display. Pump-down operation by external input was assigned to CnZ1 function regardless [P06] setting.

0: Operation output [Factory default]

1: Error output

·It is turned on at anomalous stop, and turned OFF when "CHECK" and "RESET" buttons on remote control are pressed simultaneously after recovering from the anomaly. Even if "CHECK" and "RESET" buttons are pressed before recovering from the anomaly, it is not turned OFF. But when recovering from the anomaly later, it is automatically turned OFF.

2: Compressor ON output

·It is turned ON, when the compressor is ON

3: Fan ON output

·It is turned ON, when the outdoor fan No.1 speed command > 0, or the outdoor fan No.2 speed command > 0.

4: Oil return operation output

·It is turned ON at oil return operation in cooling or at oil return operation in heating, or at defrost operation in heating.

5: When HP is relatively high

·Signal is output in order to operate a sprinkler system for cooling down the outdoor heat exchanger.

It is turned ON, when high pressure > 3.3MPa in cooling mode

If once starting operation of sprinkler system, it shall be kept operation for 30sec at least.

(7) Pump down control for replacement (Master unit/slave unit)

This control is for recovering refrigerant to outdoor unit quickly in case of replacement or relocation of the outdoor unit.

- (a) This control is performed from the master unit side. It cannot be controlled from the slave unit side. If this control is attempted from the slave unit side, the following codes are displayed on the 7-segment LED of the slave unit.

Code display area	Data display area	Contents of invalid operation
OPE	10	Setting from the slave unit is invalid

Note (1) The display returns to normal if the pump-down control switch is reset.

- (b) Pump down operation can be performed with the operation of 3 dip switches SW5-1(Test run switch), SW5-2 (Test run operation mode) and SW5-3 (Pump down switch)

(c) Pump down procedure

- 1) Shut the liquid side service valve on the outdoor units
- 2) Turn SW5-2 (test run operation mode) ON (cooling)
- 3) Turn SW5-3 (pump down switch) ON
- 4) Turn SW5-1 (test run switch) ON

(d) Ending condition

If any of the following conditions is satisfied, this control ends.

- (i) When the low pressure (LP) is preset value or less, this control ends normally, and indicates followings
 - ① Red LED: Keeps lighting
 - ② Green LED: Keeps flashing
 - ③ 7-segment display: PdE
 - ④ Remote control: Stop
- (ii) Anomalous all stop by the error detection control
- (iii) If the cumulative compressor operation time under pump down control is 15minutes (End control because time is up), this control ends and indicates followings
 - ① Red LED: Stays OFF
 - ② Green LED: Keeps flashing
 - ③ 7-segment display: No display
 - ④ Remote control: Stop
- (iv) When any of setting switch (SW5-1, SW5-2, SW5-3) is turned OFF during pump down control.

(Note) Even if only SW5-3 is turned OFF, it is not recognized as the cooling test run mode and it stops.

(8) Pump-down operation by external input

If an error stop is raised by an external input by refrigerant leaking alarm unit, the pump-down operation is performed at the outdoor unit side in order to prevent the refrigerant from leaking.

They are local arrangements.

- ① Refrigerant leaking alarm unit
- ② Valve to shut liquid pipe
- ③ Valve to shut gas pipe

Valves of ② and ③ should be selected what the pressure loss of refrigerant piping doesn't increase.

(a) Status 1: Pump-down operation

(i) Starting condition

- ① When the external input function is assigned to "0: External operation input" and the external input terminal is open (by refrigerant leaking alarm unit).
- ② If the pump-down control is valid when the error stop is raised by the setting on 7-segment. ([P19] = "1")

(ii) Contents of control

- ① ON is output on CnY, and the liquid service valve is shut down if it is connected on CnY.
- ② The pump-down operation for replacement is performed.

(iii) Ending condition

- ① When starting conditions are lost.
- ② When the pump-down operation has ended.

(b) Status 2: Emergency stop operation

(i) Starting condition

- ① When the pump-down operation has ended in the status 1.

(ii) Contents of control

- ① ON is output to CnZ1, and the gas service valve is shut down if it is connected on CnZ1.
- ② Operation stops with the error full stop. ([E63] is displayed.)

(iii) Ending condition

- ① When starting conditions for the status 1 are lost.
- ② State of error continues for 3 minutes after the error full stop. It cannot be reset in this condition from the remote control. If the starting conditions for Status 1 are not yet established later, this can be reset by the remote control inspection reset.

● Pump down external input

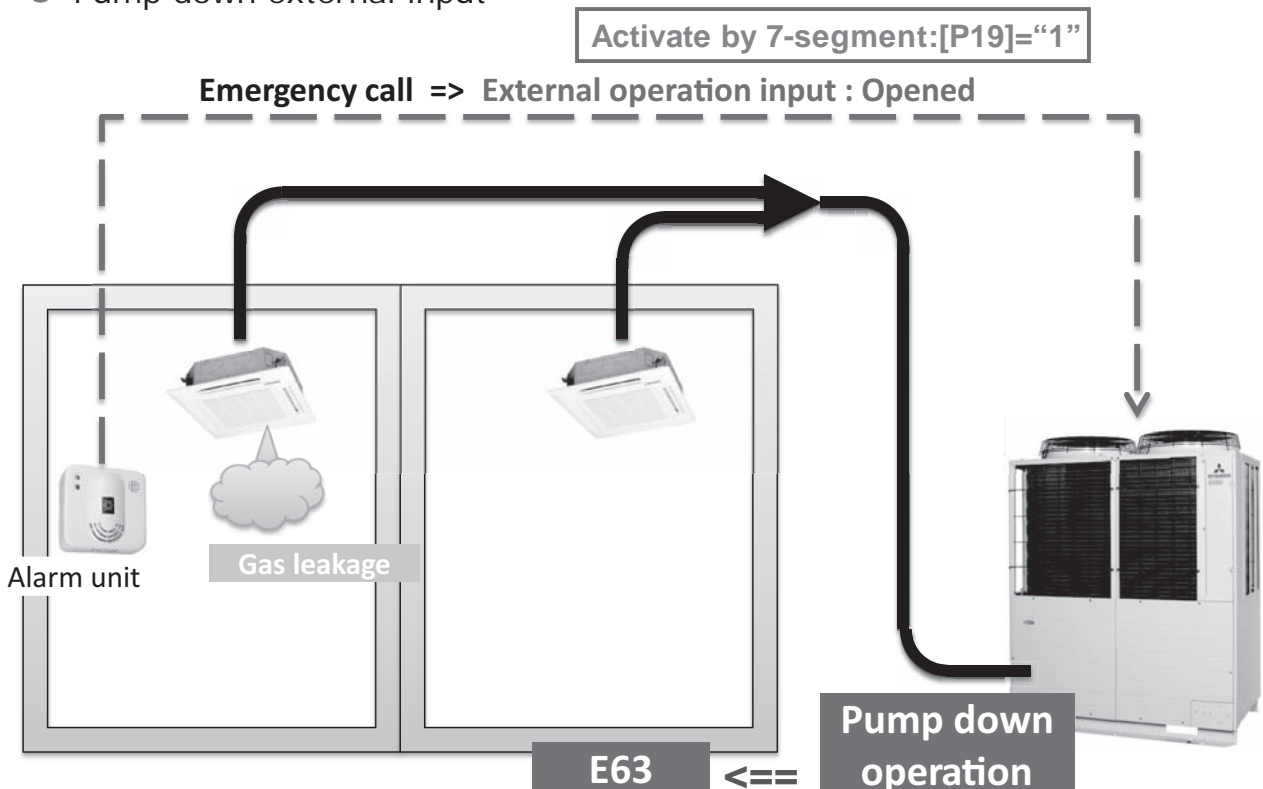

● Sample of system configuration

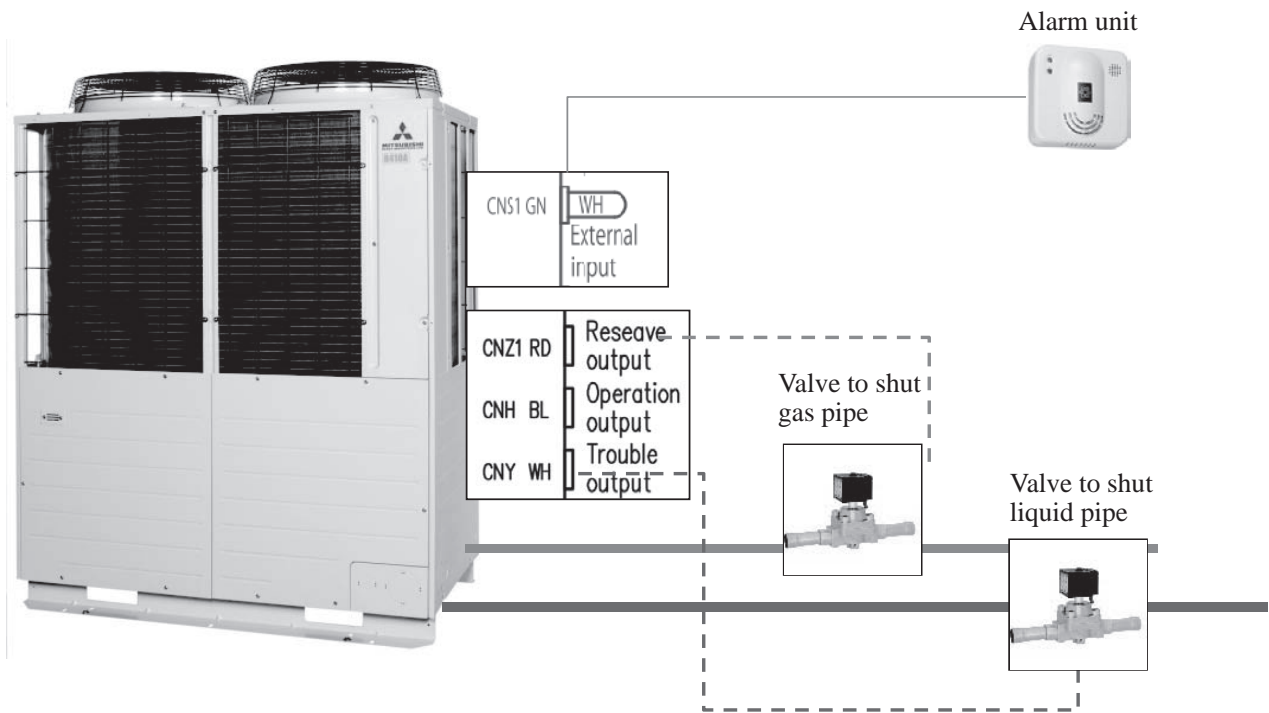

Output for valve to shut liquid pipe : CNY
 Wiring part no. PCZ006A051A
 Output for valve to shut gas pipe : CNZ1
 Wiring part no. PCZ006A051B

CNZ1 RD	Reseave output
CNH BL	Operation output
CNY WH	Trouble output

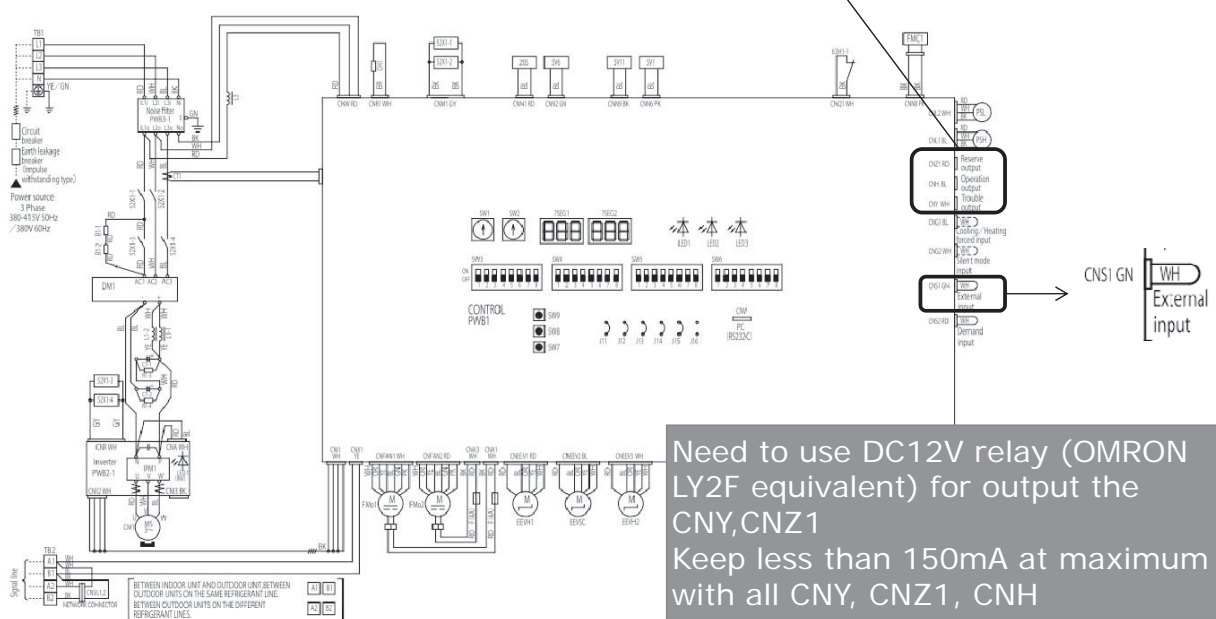

(9) Continuous Heating Capacity Control (CHCC)

(a) Starting condition

- 1) Defrost operation interval extension control
 - ① When 7-segment [P00] is set at 1.
 - ② When the defrost operation start conditions 1) – 3) are satisfied.
 - ③ When the lowest one of three outdoor heat exchanger sensor temperatures (thermistors Tho-R1, -R2 and-R5) falls in the defrost range (fig 1) which is determined by the outdoor air temperature thermistor (Tho-A) of the defrost control <Starting condition> 4).
- 2) Continuous heating control
 - ① When 7-segment [P00] is set at 2.
 - ② When the defrost operation <Starting conditions> 1) – 3) are satisfied.
 - ③ When the lowest one of three outdoor heat exchanger sensor temperatures (thermistors Tho-R1, -R2 and-R5) falls in the defrost range (temperature of fig 1 + 1°C) which is determined by the outdoor air temperature thermistor (Tho-A) of the defrost operation <Starting condition> 4).

(b) Contents of control

- 1) Lowering of the compressor capacity on each outdoor unit
 - ① Defrost operation interval extension control
It is confirmed at every 30-second that it is in the defrost operation start zone.
 - If it is in the defrost operation start zone, the compressor capacity is lowered further.
 - If it is not in the defrost operation start zone, the PI control is reset.
 - ② Continuous heating control
It is confirmed at every 30-second that it is in the defrost operation start zone (J15 shorted).
 - If it is in the defrost operation start zone (J15 shorted), the compressor capacity is lowered further.
 - If it is not in the defrost operation start zone, the PI control is reset.
- 2) The compressor capacity is lowered by the following value from actual operating condition at that time, on each compressor.

The PI control by the compressor high-low pressure control is implemented still.

All models	Extent of lowered compressor capacity
Normally	5%

- 3) If this control terminates after establishing the <Ending conditions> 4) and 8), it is not activated till the defrost operation terminates normally.
- 4) If this control terminates after establishing the <Ending condition> 5), it is not activated till all compressors on each outdoor unit detect the compressor OFF or the under-dome SH > 18 deg.

(c) Ending condition

- 1) Outdoor unit operation mode stop
- 2) When the outdoor unit operation mode changes to the cooling.
- 3) When it continues for 3 minutes the state that it runs out the defrost operation start zone.
- 4) When the following condition is satisfied on all indoor units on which the heating thermostat is turned ON.
Remote control setting temperature – Main unit suction temperature ≥ 3 deg
- 5) When either compressor on all outdoor unit has detected for 3 minutes continuously the compressor ON and also the state that the under-dome SH ≤ 15 deg.
- 6) When the defrost operation conditions are not satisfied.
- 7) Compressor OFF
- 8) When 7-segment [P00] is set at other than 1 or 2.

(10) Indoor unit forced cooling settings

Indoor units can be changed to cooling-only operation (only cooling, dehumidification and fan operations are enabled) by using external inputs CnS1, CnS2, CnG1 and CnG2.

The indoor units specified by the 7-segment P25 display are set to cooling-only operation.

The set value on the 7-segment P25 display correspond to the indoor unit addresses.

Example: P25 display is set to "5"

The indoor units with indoor unit addresses from 0 to 5 are set to cooling-only operation.

The remote control displays "Operation Disabled" if you try to change indoor units set for forced cooling to a heating setting.

(C) Data output**(1) 7-segment display and operation data retention****(a) 7-segment display**

Operation information is displayed for checking various operation data during test run and for helping malfunction diagnosis at servicing. Input data to microcomputer, contents of outdoor unit control, registration information of indoor units and etc. are mainly displayed on the 7-segment LED.

(i) Operation information display

- 1) Each item is displayed at the 7-segment LED with 6-digit on outdoor control PCB
- 2) Left 3 digits are for code display and right 3 digits are for data display
- 3) The code No. of each item is selected by pressing SW9 for the order of 10 and SW8 for the order of 1.
- 4) If the code No. is set at "C99", the data of the code No. from "C00" to "C29" is displayed cyclically.
Code No. at factory setting is "C99"
- 5) If the code No. is set at other than "C99", the data of selected code No. is kept on displaying.
- 6) The code No. "C77" is for resetting

The contents of retained operation data (the data for a period of 30 minutes prior to error stop) can be erased by setting the code No. at "C77".

The resetting method is to select the code "C77" first. (If any error data is retained, "dEL" is displayed on the data display area.)

And then when press SW7 for 3 seconds, the retained error data can be erased. However the data of the code No. "C54" and "C55" (compressor cumulative operation time) are not erased.

When the data is erased, "---" is displayed on the data display area of 7-segment LED. And this is displayed as well when no error data is retained.

- 7) If SW8 (order of 1) is pressed, it displays in the order of 0 ⇒ 1 ⇒ 2 9 ⇒ 0.
- 8) If SW9 (order of 10) is pressed, it jumps to the leading code of each order of 10
(Example) If SW9 is pressed at the code No. "C07" displayed, it jumps to the code No. "C10".
- 9) The data of code No. "C54" and "C55" can be erased independently

The compressor cumulative operation time corresponding to the code No. selected can be erased (reset). (For resetting of the compressor cumulative operation time after replacement of compressor)

The resetting method is to select the code "C54" or "C55" first. (the compressor cumulative operation time corresponding to the code No. is displayed on the data display area of 7-segment LED.)

And then when press SW7 for 3 seconds, the retained data can be erased. However the data of the retained operation data (the data for 30 minutes before error stop) are not erased.

(ii) Individual definition of display contents

- 1) Code No. "C17": Subcooling degree at cooling mode

[Subcooling degree at cooling mode] =

[High pressure saturated temperature detected with high pressure sensor (PHS)]

-[Subcooling coil temperature detected with subcooling temperature thermistor (Tho-SC)]

The calculated result is displayed after rounding to one decimal place. Or if the calculated result is a negative value, "0.0" is displayed.

During heating mode this data might be unreliable as subcooling degree, but the result is displayed as it is.

- 2) Code No. "C18": Suction superheat degree
 [Suction superheat degree] =
 [Suction pipe temperature detected with suction pipe temperature thermistor (Tho-S)]
 -[Low pressure saturated temperature detected with low pressure sensor (PLS)]
 The calculated result is displayed after rounding to one decimal place. Or if the calculated result is a negative value, "0.0" is displayed.
- 3) Code No. "C19": Superheat degree of subcooling coil
 [Superheat degree of subcooling coil] =
 [Subcooling coil temperature detected with subcooling coil temperature thermistor (Tho-H)]
 -[Low pressure saturated temperature detected with low pressure sensor (PLS)]
 The calculated result is displayed after rounding to one decimal place. Or if the calculated result is a negative value, "0.0" is displayed.
- (iii) Error code displayed at error occurrence can be reset with the dip switch SW3-1 ON.
- (iv) Discharge pressure saturated temperature and suction pressure saturated temperature are displayed after rounding to unit, if it is -10.0°C or lower. (Because the 7-segment display range is 3-digit)
- (v) Priority of display

- 1) [EXX] > [CHX] > [PCLX] > [PoE] > [PoS] > [OPE] > [CXX]

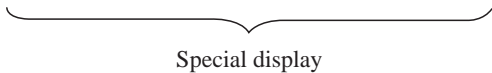

[EXX]: Error code
 [CHX]: Check mode
 [PoE], [PoS]: Pump down operation
 [OPE]: Outdoor unit setting

- 2) If the state of 1) is reset, it is automatically switched to [CXX] (Automatic data display mode)
 3) When pressing SW8 or SW9 under the state of 1), it switched to [CXX]

However the button input is not done for 10 seconds after switching to [CXX], the display is changed to the special display according to the priority of the state 1)

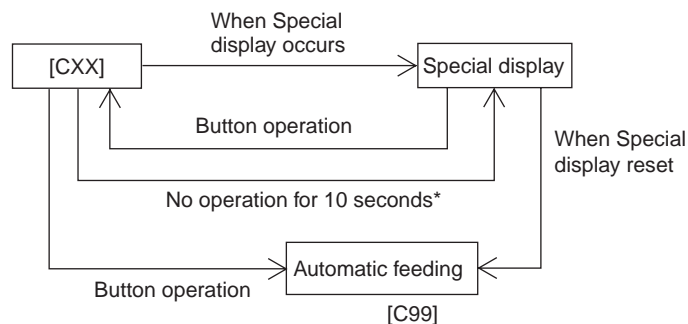

* If the special display is reset in the meanwhile, it remains [CXX].

(b) 7-Segment display

Code No.	Contents of display	Data display range	Minimum unit	Remarks
Đ	Unusual code Pump down Check mode Outdoor unit setup, piping cleaning	–	–	E?? PoE, PoS CH?, PCL? oPE??
C00	CM1 operating frequency	0 – 130	1Hz	
C01	CM2 operating frequency	0 – 130	1Hz	
C02	Tho-A Outdoor air temp.	L,-20 – 43	1°C	
C03	Tho-R1 Heat exchanger temp. 1 (Exit. Front)	L,-25 – 73	1°C	
C04	Tho-R2 Heat exchanger temp. 2 (Exit. Rear)	L,-25 – 73	1°C	
C05	Tho-R3 Heat exchanger temp. 3 (Entrance. Front)	L,-25 – 73	1°C	
C06	Tho-R4 Heat exchanger temp. 4 (Entrance. Rear)	L,-25 – 73	1°C	
C07	Tho-R5 Heat exchanger temp. 5 (Exit. Front)	L,-25 – 73	1°C	
C08	Tho-R6 Heat exchanger temp. 6 (Entrance. Front)	L,-25 – 73	1°C	
C09	Tho-D1 Discharge pipe temp. (CM1)	L,31 – 136	1°C	
C10	Tho-D2 Discharge pipe temp. (CM2)	L,31 – 136	1°C	
C11	Tho-C1 Under-dome temp. (CM1)	L,5 – 90	1°C	
C12	Tho-C2 Under-dome temp. (CM2)	L,5 – 90	1°C	
C13	Tho-P1 Power transistor temp. (CM1)	L,31 – 136	1°C	
C14	Tho-P2 Power transistor temp. (CM2)	L,31 – 136	1°C	
C15	Tho-SC Sub-cooling coil temp.1	L,18 – 73	1°C	
C16	Tho-SC Sub-cooling coil temp.2	L,-25 – 73	1°C	
C17	Tho-S Suction pipe temp.	L,-25 – 73	1°C	
C18	CT1 Current (CM1)	0 – 70	1A	
C19	CT2 Current (CM2)	0 – 70	1A	
C20	EEVH1 Heating expansion valve opening angle	0 – 500	1 Pulse	
C21	EEVH2 Heating expansion valve opening angle	0 – 500	1 Pulse	
C22	EEVH3 Heating expansion valve opening angle	0 – 500	1 Pulse	
C23	Opening angle of EEVSC overcooling coil expansion valve	0 – 500	1 Pulse	
C24	FM01 Number of rotations	0 – 1500	10 min ⁻¹	
C25	FM02 Number of rotations	0 – 1500	10 min ⁻¹	

Code No.	Contents of display	Data display range	Minimum unit	Remarks
C26	PSH High pressure sensor	0 – 5.00	0.01MPa	
C27	PSL Low pressure sensor	0 – 2.00	0.01MPa	
C31	63H1-1 63H1-2 (63H1-R)	0,1	–	Order of 100 : 63H1-1, 2 Order of 10 : 63H1-R (0: Close, 1: Open)
C32	CnS1 CnS2 CnG1	0,1	–	Order of 100 : CnS1 Order of 10 : CnS2 Order of 1 : CnG1 (0: Close, 1: Open)
C33	CnG2 SV8 SV10	0,1	–	Order of 100 : CnG1 Order of 10 : SV8 Order of 1 : SV10 (0: Close, 1: Open)
C34	52C1 52C2 CH1	0,1	–	Order of 100 : 52C1 Order of 10 : 52C2 Order of 1 : CH1 (0: Close, 1: Open)
C35	CH2 20S (20SL)	0,1	–	Order of 100 : CH2 Order of 10 : 20S Order of 1 : (20SL) (0: Close, 1: Open)
C36	FMC1,2	0,1	–	Order of 100 : FMC1,2 Order of 10 : Spare Order of 1 : Spare (0: Close, 1: Open)
C37	SV1 SV2(20UF) (SV3)	0,1	–	Order of 100 : SV1 Order of 10 : SV2(20UF) Order of 1 : (SV3) (0: Close, 1: Open)
C38	(SV4) SV6 SV7	0,1	–	Order of 100 : (SV4) Order of 10 : SV6 Order of 1 : SV7 (0: Close, 1: open)
C39	SV11 (SV13)	0,1	–	Order of 100 : SV11 Order of 10 : Spare Order of 1 : (SV13) (0: Close, 1: Open)
C40	CnZ1 CnH CnY	0,1	–	Order of 100 : CnZ1(External output) Order of 10 : CnH(Operation output) Order of 1 : CnY(Error output) (0: Close, 1: Open)
C41	Number of connected indoor unit	0 – 80	1	
C42	Capacity of connected indoor unit	0 – 999		
C43	Number of operation indoor unit	0 – 80	1	
C44	Required Fk total	0 – 999	1Hz	
C45	Compressor cumulative operating time (CM1)	0 – 655	100h	
C46	Compressor cumulative operating time (CM2)	0 – 655	100h	
C47	Discharge pressure saturation temperature	-50 – 70	0.1°C	Minimum unit 1°C at -10°C or lower
C48	Suction pressure saturation temperature	-50 – 30	0.1°C	Minimum unit 1°C at -10°C or lower
C49	Tho-SC1 saturated pressure	-0.68 – 4.15	0.01MPa	
C50	Cooling operation subcooling	0 – 50	1deg	
C51	Superheat	0 – 50	1deg	
C52	Superheat of subcooling coil	0 – 20	1deg	SHS
C53	Tho-C1 Superheat	0 – 50	0.1deg	
C54	Tho-C2 Superheat	0 – 50	0.1deg	
C55	Target cooling low pressure	0.00 – 2.00	0.01MPa	
C56	Target heating high pressure	1.60 – 4.15	0.01MPa	

Code No.	Contents of display	Data display range	Minimum unit	Remarks
C57	Target Fk	0 – 999	1Hz	
C58	Inverter 1 operating frequency command	0 – 140	1rps	
C59	Inverter 2 operating frequency command	0 – 140	1rps	
C60	FMo1 operating revolution command	0 – 999	10min ⁻¹	
C61	FMo2 operating revolution command	0 – 999	10min ⁻¹	
C62	Demand ratio	0 – 100	1%	Only displaying
C65	Outdoor operating mode pattern	0 – 127	1	
C66	Control status	0 – 127	1	
C67	Protection control status	0 – 127	1	See table on page 56
C68	Compressor stop causes	0 – 127	1	See table on page 57
C69	Time elapsed after compressor stop cause	0 – 255	1h	
C70	Protection control causes 1	0 – 127	1	Displays No. of the protection control of which effect is the strongest among those occurred from the start of operation after the power on.
C71	Protection control causes 2	0 – 127	1	Displays No. of the protection control of which effect is stronger secondly among those occurred from the start of operation after the power on.
C72	Protection control causes 3	0 – 127	1	Displays No. of the protection control of which effect is stronger thirdly among those occurred from the start of operation after the power on.
C73	Compressor error causes 1	0 – 127	1	Displays No. of the error detection of which effect is the strongest among those occurred from the start of operation after the power on.
C74	Compressor error causes 2	0 – 127	1	Displays No. of the error detection of which effect is stronger secondly among those occurred from the start of operation after the power on.
C75	Compressor error causes 3	0 – 127	1	Displays No. of the error detection of which effect is stronger thirdly among those occurred from the start of operation after the power on.
C80	Counter · Current cut (CM1)	0 – 255	1	EEPROM memory. Resettable.
C81	Counter · Current cut (CM2)	0 – 255	1	EEPROM memory. Resettable.
C82	Counter · Power transistor overheat (CM1)	0 – 255	1	EEPROM memory. Resettable.
C83	Counter · Power transistor overheat (CM2)	0 – 255	1	EEPROM memory. Resettable.
C84	Counter · Compressor startup failure (CM1)	0 – 255	1	EEPROM memory. Resettable.
C85	Counter · Compressor startup failure (CM2)	0 – 255	1	EEPROM memory. Resettable.
C86	Counter · Anomalous compressor by loss of synchronism (CM1)	0 – 255	1	EEPROM memory. Resettable.
C87	Counter · Anomalous compressor by loss of synchronism (CM2)	0 – 255	1	EEPROM memory. Resettable.
C88	Counter · Communication error between inverter PCB and outdoor control (CM1)	0 – 255	1	EEPROM memory. Resettable.
C89	Counter · Communication error between inverter PCB and outdoor control (CM2)	0 – 255	1	EEPROM memory. Resettable.
C90	Counter · Anomalous FMo1	0 – 255	1	EEPROM memory. Resettable.

Code No.	Contents of display	Data display range	Minimum unit	Remarks
C91	Counter · Anomalous FMO2	0 – 255	1	EEPROM memory. Resettable.
C92	Counter · Indoor-outdoor communications error	0 – 255	—	EEPROM memory. Resettable.
C93	Counter · CPU reset	0 – 255	—	
C94	Auto back up capable time	0 – 80	1h	
C97	Program sub-version	0 – 991	—	
C98	Program POL version	0.00 – 9.99	0.01	
C99	Auto send display	—	—	
P00	Continuous Heating Capacity Control (CHCC)	0: (Factory default) 0, 1, 2	—	
P01	Spare	3: (Factory default)	—	
P02	Outdoor fan snow protection control	0: (Factory default) 0, 1	—	0 : Invalid 1 : Valid
P03	Outdoor fan snow protection control ON time setting	30: (Factory default) 10,30 – 600(sec)	30	Changes to 10, 30, 60, 90 ... 600.
P04	Many steps demand setting (1st step demand)	080: (Factory default) 000,040,060,080	—	
P05	Silent mode setting	0: (Factory default) 0 – 3	1	
P06	CnZ1 function assignment	0: (Factory default) 0 – 9	1	
P07	CnS1 function assignment	0 – 12	1	Factory setting: 0 (External operation input)
P08	CnS2 function assignment	0 – 12	1	Factory setting: 1 (Demand input)
P09	CnG1 function assignment	0 – 12	1	Factory setting: 2 (Forced cooling/heating input)
P10	CnG2 function assignment	0 – 12	1	Factory setting: 3 (Silent mode input)
P11	Spare	0: (Factory default)	—	
P12	Spare	110: (Factory default)	—	
P13	Spare	0: (Factory default)	—	
P14	Many steps demand setting. (2nd step demand)	080: (Factory default) 000,040,060,080	—	
P15	Many steps demand setting. (3rd step demand)	080: (Factory default) 000,040,060,080	—	
P16	Spare	1: (Factory default)	—	
P17	After changing mode from operation prohibition mode	0: (Factory default) 0, 1	1	
P18	Spare	0: (Factory default)	—	
P19	Pump-down operation by external input	0: (Factory default) 0, 1	1	

Code No.	Contents of display	Data display range	Minimum unit	Remarks
P20	Spare	1: (Factory default)	—	
P21	Spare	-1: (Factory default)	—	
P22	Spare	39: (Factory default)	—	
P23	Spare	1: (Factory default)	—	
P24	Spare	20: (Factory default)	—	
P25	Spare	-1: (Factory default)	—	
P28	Spare	0: (Factory default)	—	
P29	Spare	0: (Factory default)	—	
P30	Superlink communication status	0,1	—	0: Current Superlink 1: New Superlink
P31	Start automatic address setting		—	0: Automatic address setting standby 1: Automatic address setting start
P32	Input stating indoor address	$\frac{0: (\text{Factory default})}{1 - 127}$	1	Specify the starting indoor address connected in one refrigerant system for automatic address setting.
P33	Input the number of connected indoor units	$\frac{0: (\text{Factory default})}{1 - 24(*)}$	1	Specify the number of indoor units connected in one refrigerant system for automatic address setting. (*) Maximum connectable number of indoor units for each outdoor unit
P34	Polarity definition	$\frac{0: (\text{Factory default})}{0, 1}$	—	0: Network polarity not defined 1: Network polarity defined
P35	Spare	0: (Factory default)	—	
P37	Spare	0: (Factory default)	—	
P38	Spare	0: (Factory default)	—	
P39	Spare	0: (Factory default)	—	
P40	Spare	0.00: (Factory default)	—	
P41	Spare	0.00: (Factory default)	—	
P42	Spare	40: (Factory default)	—	
P43	Spare	3.15: (Factory default)	—	
P44	Spare	30: (Factory default)	—	
P45	Spare	000: (Factory default)	—	
P46	Spare	000: (Factory default)	—	
P47	Spare	000: (Factory default)	—	
P48	Spare	0: (Factory default)	—	
P49	Spare	0: (Factory default)	—	
P50	Spare	8: (Factory default)	—	

Code No.	Contents of display	Data display range	Minimum unit	Remarks
P51	Spare	0.5: (Factory default)	—	
P52	Spare	3: (Factory default)	—	
P53	Spare	0: (Factory default)	—	
P54	Spare	5: (Factory default)	—	
P55	Spare	0: (Factory default)	—	
P56	Spare	6: (Factory default)	—	
P57	Spare	40: (Factory default)	—	
P58	Spare	5: (Factory default)	—	
P59	Spare	50: (Factory default)	—	
P60	Spare	0: (Factory default)	—	
P61	Spare	20: (Factory default)	—	
P62	Spare	0: (Factory default)	—	
P63	Spare	16: (Factory default)	—	
P64	Spare	0: (Factory default)	—	
P65	Spare	0: (Factory default)	—	
P66	Spare	10: (Factory default)	—	
P67	Spare	56: (Factory default)	—	
P68	Spare	0: (Factory default)	—	
P69	Multi-system energy save control I	0: (Factory default) 0, 1	1	
P70	Spare	0.5: (Factory default)	—	
P71	Spare	33: (Factory default)	—	
P72	Spare	0: (Factory default)	—	
P73	Spare	0.00: (Factory default)	—	
P74	Spare	0.00: (Factory default)	—	
P75	Spare	0: (Factory default)	—	
P76	Spare	0: (Factory default)	—	
P77	Spare	20: (Factory default)	—	
P78	Spare	0: (Factory default)	—	

Code No.	Contents of display	Data display range	Minimum unit	Remarks
P79	Spare	1.5: (Factory default)	—	
P80	Spare	0: (Factory default)	—	
P81	Spare	0: (Factory default)	—	
P82	Spare	0: (Factory default)	—	
P83	Spare	0: (Factory default)	—	
P84	Spare	0: (Factory default)	—	
P87	Spare	1.8: (Factory default)	—	
P88	Spare	0: (Factory default)	—	
P89	Spare	15: (Factory default)	—	
P90	Spare	10: (Factory default)	—	
P91	Spare	0: (Factory default)	—	
P92	Spare	0: (Factory default)	—	
P93	Spare	7: (Factory default)	—	
P96	Spare	0: (Factory default)	—	
P98	Spare	40: (Factory default)	—	
P99	Spare	0: (Factory default)	—	
F00	Spare	0: (Factory default)	—	
F01	Spare	0: (Factory default)	—	
F02	Spare	0: (Factory default)	—	
F03	Spare	0: (Factory default)	—	
F04	Spare	0: (Factory default)	—	
F05	Spare	0: (Factory default)	—	
F06	Spare	0: (Factory default)	—	
F07	Spare	0: (Factory default)	—	
F08	Spare	1: (Factory default)	—	
F09	Spare	0: (Factory default)	—	
F10	Spare	0: (Factory default)	—	
F11	Spare	0: (Factory default)	—	

Code No.	Contents of display	Data display range	Minimum unit	Remarks
F12	Spare	0: (Factory default)	—	
F13	Spare	0: (Factory default)	—	
F14	Spare	0: (Factory default)	—	
F15	Spare	0: (Factory default)	—	
AUX	Auto address setting on			
AUE	Indoor unit address No. assignment normal ending			
A01	Indoor unit address No. assignment error 1			
A02	Indoor unit address No. assignment error 2			
A03	Indoor unit address No. assignment error 3			
A04	Superlink setting error			

[C67] Protection control status

<Definition of signal>

Shows the status of protection control in operation currently.

If two or more controls among the following protection controls are established simultaneously, No. of the control of which number is larger is displayed.

	Protection control status	Number
Ordinary control	No operation of protective control	0
Protection control	During HP protection	1
	Spare	2
	During LP protection	3
	During discharge temperature	4
	During specific pressure protection	5
	During under-dome temperature protection	6
	During current safe protection	7
	During power transistor temperature protection	8

[C68] Compressor stop causes**<Definition of signal>**

Shows the latest compressor stop cause counted from right now.

(Excluding the ordinary stop, etc.)

Output of the No. is retained till next compressor stop cause occurs.

	Compressor stop causes	Number
	No history	0
Sensor wire breakage	Tho-A	1
	Tho-R1	2
	Tho-R2	3
	Tho-R3	4
	Tho-R4	5
	Tho-D1	6
	Tho-D2	7
	Tho-SC	8
	Tho-H	9
	Tho-S	10
	Tho-C1	11
	Tho-C2	12
	Tho-P1	13
	Tho-P2	14
	High pressure sensor	15
	Low pressure sensor	16
	Tho-R5	17
	Tho-R6	18
System error	High pressure anomaly	20
	Low pressure anomaly	21
	Discharge temperature error (Tho-D1)	22
	Discharge temperature error (Tho-D2)	23
	Liquid flooding anomaly (CM1)	24
	Liquid flooding anomaly (CM2)	25
Spare	26	
Fan • Compressor Communication error	Outdoor DC fan motor anomaly (FMo1)	30
	Outdoor DC fan motor anomaly (FMo2)	31
	Current cut (CM1)	32
	Current cut (CM2)	33
	Power transistor overheat (CM1)	34
	Power transistor overheat (CM2)	35
	Compressor startup failure (CM1)	36
	Compressor startup failure (CM2)	37
	Communication error between inverter PCB and outdoor control (CM1)	38
	Communication error between inverter PCB and outdoor control (CM2)	39
	Anomalous compressor by loss of synchronism (CM1)	40
	Anomalous compressor by loss of synchronism (CM2)	41
Communication error between the master unit and slave units	42	
Compressor stop by control	Operation mode change	50
	Differential pressure startup prevention control	51
	Protect for heating overload	52
	Spare	53

(c) Saving of Operation Data

For the purpose to investigate the cause of trouble in the field, the operation data are always saved in the memory, and if the trouble occurs, the data writing is stopped and the operation data prior to the trouble occurrence are recorded. These data can be retrieved to personal computer through RS-232C connector on the outdoor control PCB and utilized for probing the cause.

- (i) Operation data for a period of 30 minutes prior to the present operation are saved and updated sequentially .
- (ii) If an anomalous stop occurs, the data are not updated any more.
- (iii) Data are written in at 1-minute interval and following data will be transmitted to PC upon demand.

Data	Data Range	Example
Software version	Ascii 15 byte	KV1C100##### (#: NULL)
PID (program ID)	Ascii 2 byte	5D
Outdoor unit capacity	Ascii 3 byte	As shown in table at right
Power source frequency	Ascii 2 byte	60
Outdoor address	Ascii 2 byte	00 – 3F
Indoor address × 16 units	Ascii 2 byte × 16 units	40 – 7F
Indoor capacity × 16 units	Ascii 3 byte × 16 units	022 – 280

Outdoor unit capacity data	Outdoor unit capacity data	Remarks
Single type	Example: 20HP - [S20]	S: Display with Horse Power of single type or single use of combination type
Master unit of combination type	Example: 40HP - [S40]	S: Display with Horse Power of master unit of combination type
Slave unit of combination type	Example: 20HP - [C20]	C: Display with Horse Power of slave unit of combination type

- (iv) Error retention and monitoring data

< Indoor unit indicate data >

Code No.	Write-in contents	Record data				
		Data write-in range	Write-in unit	Number of bytes	Contents	
00	Indoor unit 1 Thi-A	10 – 52	1°C	1	Air inlet temp.	
01	Indoor unit 1 Thi-R1	-19 – 71	1°C	1	Heat exchanger temp. 1	
02	Indoor unit 1 Thi-R2	-19 – 71	1°C	1	Heat exchanger temp. 2	
03	Indoor unit 1 Thi-R3	-19 – 71	1°C	1	Heat exchanger temp. 3	
04	Indoor unit 1 EEV	0 – 470	1 pulse	2		
05	Indoor unit I setting temperature	0 – 127	0.5°C	1	05H command	
06	Indoor unit I Operation mode/Air capacity	0 – 500	-	2	0	Not used (Data not received)
					100	Dehumidifying stop 0-speed
					110	Dehumidifying operation 0-speed
					111	Dehumidifying operation 1-speed
					112	Dehumidifying operation 2-speed
					113	Dehumidifying operation 3-speed
					114	Dehumidifying operation 4-speed
					115	Dehumidifying operation 5-speed
					116	Dehumidifying operation 6-speed
					200	Cooling stop 0-speed
					210	Cooling operation 0-speed
					211	Cooling operation 1-speed
					212	Cooling operation 2-speed
					213	Cooling operation 3-speed
					214	Cooling operation 4-speed
					215	Cooling operation 5-speed
					216	Cooling operation 6-speed
					300	Fan stop 0-speed
					310	Fan operation 0-speed
					311	Fan operation 1-speed
312	Fan operation 2-speed					
313	Fan operation 3-speed					
314	Fan operation 4-speed					
315	Fan operation 5-speed					
316	Fan operation 6-speed					
400	Heating stop 0-speed					
410	Heating operation 0-speed					

Code No.	Write-in contents	Record data			
		Data write-in range	Write-in unit	Number of bytes	Contents
					411 Heating operation 1-speed 412 Heating operation 2-speed 413 Heating operation 3-speed 414 Heating operation 4-speed 415 Heating operation 5-speed 416 Heating operation 6-speed
07	Indoor unit 1 Demand frequency	0 – 255	1 Hz	1	
08	Indoor unit 1 Answer frequency	0 – 255	1 Hz	1	
09	Indoor unit 1 Indoor local	—	—	1	Bit0 Anti-frost
					Bit1 Aperture command ON
10	Indoor unit 1 Thi spare	-10 – 52	1°C	1	Air outlet temp.
11	Indoor unit 1 Model	0 – 85	—	1	0 FDT
					1 FDK
					2 other
					3 FDE
					4 FDTC
					5 Outdoor air intake unit
					6 Spacious area
					7 Outdoor air treatment
12	Indoor unit 1 PID	—	—	1	
Data contents for indoor 2 to 16 are same as above.					

<Outdoor unit indicate data>

Code No.	Write-in contents	Record data			
		Data write-in range	Write-in unit	Number of bytes	Contents
00	Anomalous code	00 – 99	—	1	00: No anomalous, outdoor unit all anomalous ???
01	Address of unit where trouble occurred	00 – FF	—	1	00~3F: Outdoor unit side, 40~6F: Indoor unit side
02	Tho-A Outdoor air temp.	-20 – 70	A/D value	1	
03	Heat exchanger temp. 1 (Exit, Front)	-35 – 75	A/D value	2	Cooling liquid side
04	Heat exchanger temp. 2 (Exit, Rear)	-35 – 75	A/D value	2	Cooling liquid side
05	Heat exchanger temp. 3 (Entrance, Front)	-35 – 75	A/D value	2	Cooling gas side
06	Heat exchanger temp. 4 (Entrance, Rear)	-35 – 75	A/D value	2	Cooling gas side
07	Heat exchanger temp. 5 (Exit, Front)	-35 – 75	A/D value	2	Cooling liquid side
08	Heat exchanger temp. 6 (Entrance, Front)	-35 – 75	A/D value	2	Cooling gas side
09	Tho-D1 Discharge pipe temp. (CM1)	20 – 140	A/D value	1	
10	Tho-D2 Discharge pipe temp. (CM2)	20 – 140	A/D value	1	
11	Tho-C1 Under-dome temp. (CM1)	-15 – 90	A/D value	1	
12	Tho-C2 Under-dome temp. (CM2)	-15 – 90	A/D value	1	
13	Tho-P1 Power transistor temp. (Heat dissipation fin)	20 – 140	A/D value	1	
14	Tho-P2 Power transistor temp. (Heat dissipation fin)	20 – 140	A/D value	1	

Code No.	Write-in contents	Record data			
		Data write-in range	Write-in unit	Number of bytes	Contents
15	Tho-S Suction pipe temp.	-35 – 75	A/D value	2	
16	Tho-SC Subcooling coil temp. 1	18 – 73	A/D value	1	Liquid pipe side
17	Tho-H Sub cooling coil temp.2	-35 – 75	A/D value	2	Suction pipe side
18	CT1 Current	0 – 50	A/D value	1	
19	CT2 Current	0 – 50	A/D value	1	
20	Inverter secondary current 1	0 – 50	A/D value	1	
21	Inverter secondary current 2	0 – 50	A/D value	1	
22	High pressure sensor	0.00 – 5.00	A/D value	1	
23	Low pressure sensor	0.00 – 2.00	A/D value	1	
24	Liquid pipe pressure sensor	0.00 – 4.15	A/D value	1	
25	Indoor unit connection number	0 – 255	1 unit	1	
26	Indoor unit connection capacity	0 – 65535	—	2	
27	Indoor unit thermostat ON number	0 – 255	1 unit	1	
28	Indoor unit cooling thermostat ON capacity	0 – 65535	—	2	
29	Indoor unit heating thermostat ON capacity	0 – 65535	—	2	
30	Operation mode	0 – 2	—	1	0 Stop
					1 Cooling
					2 Heating
31	Spare (Outdoor unit operation pattern)	0 – 255	1	1	Real range is 1 – 17
32	CM1 frequency	0 – 130	1 rps	1	
33	CM2 frequency	0 – 130	1 rps	1	
34	FM01 Number of rotations	0 – 65535	10 min ⁻¹	2	
35	FM02 Number of rotations	0 – 65535	10 min ⁻¹	2	
36	Required Hz total	0 – 65535	1Hz	2	
37	Discharge pressure saturation temp.	-50 – 70	0.1°C	2	
38	Intake pressure saturation temp.	-50 – 70	0.1°C	2	
39	Pressure ratio	1.0 – 10.0	0.1	1	
40	Cooling operation subcooling	0 – 50	A/D value	1	
41	Superheat of suction pipe	0 – 50	A/D value	1	
42	Superheat of subcooling coil	0 – 50	A/D value	1	

Code No.	Write-in contents	Record data					
		Data write-in range	Write-in unit	Number of bytes	Contents		
43	Under-dome super heat CM1	-32768 – -32767	0.01°C	2			
44	Under-dome super heat CM2	-32768 – -32767	0.01°C	2			
45	Target FK	0 – 65535	1Hz	2			
46	Inverter CM1 operation frequency	0 – 255	1Hz	1			
47	Inverter CM2 operation frequency	0 – 255	1Hz	1			
48	FMo1 rotation command	0 – 2550	10 min ⁻¹	1			
49	FMo2 rotation command	0 – 2550	10 min ⁻¹	1			
50	EEVH1 opening angle	0 – 65535	1pulse	2			
51	EEVH2 opening angle	0 – 65535	1pulse	2			
52	EEVH3 opening angle	0 – 65535	1pulse	2			
53	EEVSC opening angle	0 – 65535	1pulse	2			
54	Target cooling low pressure of compressor	0.00 – 2.00	0.01MPa	1			
55	Target heating high pressure of compressor	0.00 – 4.15	0.01MPa	2			
56	Target differential temperature of heating CSST	0 – 127	1°C	1	Real range is 5 – 30 deg		
57	Spare	—	—	1			
58	Target superheat of outdoor unit EEVSC	0 – 25.5	0.1°C	1			
59	Spare	—	—	1			
60	Spare	—	—	1			
61	Spare	—	—	1			
62	Output of relay	—	—	1	Bit0	52C1	0: OFF, 1: ON
					Bit1	52C2	0: OFF, 1: ON
					Bit2	CH1	0: OFF, 1: ON
					Bit3	CH2	0: OFF, 1: ON
					Bit4	20S1	0: OFF, 1: ON
					Bit5	20SL	0: OFF, 1: ON
					Bit6	FMC1,2	0: OFF, 1: ON
					Bit7	Spare(FMC3)	0: OFF, 1: ON
63	Output of relay	—	—	1	Bit0	SV1	0: OFF, 1: ON
					Bit1	SV2(20UF)	0: OFF, 1: ON
					Bit2	20S3	0: OFF, 1: ON
					Bit3	SV6	0: OFF, 1: ON
					Bit4	SV7	0: OFF, 1: ON
					Bit5	Spare(SV8)	0: OFF, 1: ON
					Bit6	Spare(SV10)	0: OFF, 1: ON
					Bit7	SV11	0: OFF, 1: ON
64	Output of relay	—	—	1	Bit0	Spare(SV12)	0: OFF, 1: ON
					Bit1	Spare(SV13)	0: OFF, 1: ON
					Bit2	Spare	0: OFF, 1: ON
					Bit3	Spare	0: OFF, 1: ON
					Bit4	Spare	0: OFF, 1: ON
					Bit5	CnZ1	0: OFF, 1: ON
					Bit6	CnH	0: OFF, 1: ON
					Bit7	CnY	0: OFF, 1: ON
65	Compressor 1 cumulative operating time (estimate)	0 – 65535	h	2			

Code No.	Write-in contents	Record data			
		Data write-in range	Write-in unit	Number of bytes	Contents
66	Compressor 2 cumulative operating time (estimate)	0 – 65535	h	2	
67	Compressor 1 start times	0 – 65535	20 times	2	
68	Compressor 2 start times	0 – 65535	20 times	2	
69	Control status CM1 3-minute delay timer	0 – 180	1 second	1	
70	Control status CM2 3-minute delay timer	0 – 180	1 second	1	
71	Control status CH compressor protection timer	0 – 360	3 minutes	1	
72	Control status CH compressor protective start	0 – 15	—	1	15 Protective start end
					0 – 14 During protective start
73	Control status Oil equalization	0 – 127	—	1	0 None
					1 Oil equalized rotation
					10 Oil equalized operation 1
					20 Oil equalized operation 2
					30 Oil equalized operation 3
					41 Oil equalized operation 4-1
					42 Oil equalized operation 4-2
					51 Oil equalized operation 5-1
					52 Oil equalized operation 5-2
					61 Oil equalized operation 6-1
					62 Oil equalized operation 6-2
					71 Oil equalized operation 7-1
					72 Oil equalized operation 7-2
					81 Oil equalized operation 8-1
82 Oil equalized operation 8-2					
74	Control status Oil return	0 – 2	—	1	0 None
					1 Oil return (cooling)
					2 Oil return (gas cycle)
75	Control status Defrost kinds + defrost status	0 – 127	—	1	0 None
					11 Thermal condition defrost status 1
					12 Thermal condition defrost status 2
					13 Thermal condition defrost status 3
					14 Thermal condition defrost status 4
					21 Strength type thermal condition defrost status 1
					22 Strength type thermal condition defrost status 2
					23 Strength type thermal condition defrost status 3
					24 Strength type thermal condition defrost status 4
					31 Time condition defrost status 1
					32 Time condition defrost status 2
					33 Time condition defrost status 3
					34 Time condition defrost status 4
					76
1 Compressor OFF					
2 For 70 seconds after compressor ON					
3 After 70 to 180 seconds after compressor ON					
4 After 180 to 195 seconds after compressor ON					
77	Control status 1	—	—	1	Bit0 Superlink communication state 0: SL I (old SL) 1: SL II (new SL)
					Bit1 In trial operation control 0: Normal 1: Practice
					Bit2 In demand control 0: Normal 1: Practice
					Bit3 Silent mode 0: Normal 1: Practice
					Bit4 Spare 0: Normal 1: Practice
					Bit5 Spare 0: Normal 1: Practice
					Bit6 Spare 0: Normal 1: Practice
					Bit7 In pump-down control at Start/Stop 0: Normal 1: Practice
78	Control status 2	—	—	1	Bit0 In low outdoor temperature control 0: Normal 1: Practice
					Bit1 In for replacement pump-down control 0: Normal 1: Practice
					Bit2 Compressor dilution protection 0: Normal 1: Practice
					Bit3 Outdoor heat exchanger refrigerant purge 0: Normal 1: Practice
					Bit4 Indoor heat exchanger refrigerant purge 0: Normal 1: Practice
					Bit5 Spare 0: Normal 1: Practice

Code No.	Write-in contents	Record data					
		Data write-in range	Write-in unit	Number of bytes	Contents		
79	Control status 3	—	—	1	Bit6	Spare	0: Normal 1: Practice
					Bit7	Spare	0: Normal 1: Practice
					Bit0	Auto backup operation	0: Normal 1: Practice
					Bit1	Spare	0: Count 1: Count up
					Bit2	Spare	0: Count 1: Count up
					Bit3	Spare	0: Count 1: Count up
					Bit4	Spare	0: Count 1: Count up
					Bit5	Spare	0: Count 1: Count up
					Bit6	Spare	0: Count 1: Count up
81	Backup cumulative time	0 – 127	1 hour	1			
82	Check operation status	0 – 2	—	1	0	Normal	
					1	Insufficient check operation start condition	
					2	Check operation warm-up	
					3	Check operation ON	
					4	Check operation stop	
					5	Operation valve is closed	
					6	Indoor unit abnormal	
					7	Normal ending of check operation	
83	Spare						
84	Control status Refrigerant quantity check	0 – 127	—	1			
85	Protection control status 1	—	—	1	Bit0	HP protection 1 Compressor capacity control	0: Normal 1: Practice
					Bit1	HP protection 2 Gas bypass control	0: Normal 1: Practice
					Bit2	HP protection 3 Heating stop indoor unit slight opening control	0: Normal 1: Practice
					Bit3	LP protection 1 Compressor capacity control	0: Normal 1: Practice
					Bit4	LP protection 2 Compressor rising rate control	0: Normal 1: Practice
					Bit5	LP protection 3 Outdoor unit EEV control	0: Normal 1: Practice
					Bit6	LP protection 4 Oil separator SV control	0: Normal 1: Practice
					Bit7	Td protection 1 Compressor capacity control	0: Normal 1: Practice
86	Protection control status 2	—	—	1	Bit0	Td protection 2-1 EEVSC-Td cooling control	0: Normal 1: Practice
					Bit1	Td protection 2-2 EEVH-Td cooling control	0: Normal 1: Practice
					Bit2	Td protection 4 Heating stop indoor unit slight opening control	0: Normal 1: Practice
					Bit3	Td protection 5 Outdoor unit EEV control	0: Normal 1: Practice
					Bit4	CS protection 1 Compressor capacity control	0: Normal 1: Practice
					Bit5	Tc protection 1 Compressor capacity control	0: Normal 1: Practice
					Bit6	Tc protection 2 Gas bypass control	0: Normal 1: Practice
					Bit7	Tc protection 3 CM dilution protection control	0: Normal 1: Practice
87	Protection control status 3	—	—	1	Bit0	CM protection 1 Compressor capacity control	0: Normal 1: Practice
					Bit1	CM protection 2 Outdoor unit EEV control	0: Normal 1: Practice
					Bit2	PT protection 1 Compressor capacity control	0: Normal 1: Practice
					Bit3	PT protection 2 Inverter cooling fan control	0: Normal 1: Practice
					Bit4	Dilution rate protection	0: Normal 1: Practice
88	Protection control causes 1	0 – 127	—	1			
89	Protection control causes 2	0 – 127	—	1			

Code No.	Write-in contents	Record data			
		Data write-in range	Write-in unit	Number of bytes	Contents
90	Protection control causes 3	0 – 127	—	1	
91	Compressor stop causes	0 – 127	—	1	
92	Compressor stop causes lapse of time	0 – 255	1h	1	
93	Control status High pressure anomaly (63H1) counter	0 – 5	—	1	
94	Control status Low pressure anomaly (running) counter	0 – 5	—	1	
95	Control status Low pressure anomaly (starting) counter	0 – 5	—	1	
96	Control status Low pressure anomaly (stopped) counter	0 – 5	—	1	
97	Control status Discharge temperature error (Tho-D1) counter	0 – 5	—	1	
98	Control status Discharge temperature error (Tho-D2) counter	0 – 5	—	1	
99	Control status Cut off sensor counter	0 – 5	—	1	
100	Control status Liquid flooding anomaly counter	0 – 3	—	1	
101	Counter · Current cut (CM1)	0 – 255	—	1	
102	Counter · Current cut (CM2)	0 – 255	—	1	
103	Counter · Power transistor overheat (CM1)	0 – 255	—	1	
104	Counter · Power transistor overheat (CM2)	0 – 255	—	1	
105	Counter · Compressor startup failure (CM1)	0 – 255	—	1	
106	Counter · Compressor startup failure (CM2)	0 – 255	—	1	
107	Counter · Anomalous compressor by loss of synchronism (CM1)	0 – 255	—	1	
108	Counter · Anomalous compressor by loss of synchronism (CM2)	0 – 255	—	1	
109	Counter · Communication error between inverter PCB and outdoor control (CM1)	0 – 255	—	1	
110	Counter · Communication error between inverter PCB and outdoor control (CM2)	0 – 255	—	1	
111	Counter · Anomalous FMo1	0 – 255	—	1	
112	Counter · Anomalous FMo2	0 – 255	—	1	
113	Counter · Indoor-outdoor communications error	0 – 255	—	1	
114	Counter · CPU reset	0 – 255	—	1	
115	Compressor error causes 1	0 – 127	—	1	
116	Compressor error causes 2	0 – 127	—	1	
117	Compressor error causes 3	0 – 127	—	1	

Code No.	Write-in contents	Record data					
		Data write-in range	Write-in unit	Number of bytes	Contents		
118	INV 1 information	—	—	1	Version (Initial value FFh)		
119		—	—	1	DIP SW (Initial value FFh)		
120	INV 2 information	—	—	1	Version (Initial value FFh)		
121		—	—	1	DIP SW (Initial value FFh)		
122	Indoor unit control status 1	Error causes status	—	1	Bit0	Spare	0: Normal 1: Practice
					Bit1	Spare	0: Normal 1: Practice
					Bit2	Spare	0: Normal 1: Practice
					Bit3	Indoor unit cooling startup control 1 (normal)	0: Normal 1: Practice
					Bit4	Indoor unit cooling startup control 2 (prevent liquid back)	0: Normal 1: Practice
					Bit5	Indoor unit heating startup control	0: Normal 1: Practice
					Bit6	Indoor unit outlet temp. of heating control assist	0: Normal 1: Practice
					Bit7	Indoor unit refrigerant withdrawing control	0: Normal 1: Practice
123	Indoor unit control status 2	—	—	1	Bit0	Spare	0: Normal 1: Practice
					Bit1	Spare	0: Normal 1: Practice
124	External input	—	—	1	Bit0	63H1	0: OFF 1: ON
					Bit1	Spare	0: OFF 1: ON
					Bit2	CnS1	0: OFF 1: ON
					Bit3	CnS2	0: OFF 1: ON
					Bit4	CnG1	0: OFF 1: ON
					Bit5	CnG2	0: OFF 1: ON
125	DIP SW [SW 3]	—	—	1	Bit0	SW3-1	0: OFF 1: ON
					Bit1	SW3-2	0: OFF 1: ON
					Bit2	SW3-3	0: OFF 1: ON
					Bit3	SW3-4	0: OFF 1: ON
					Bit4	SW3-5	0: OFF 1: ON
					Bit5	SW3-6	0: OFF 1: ON
					Bit6	SW3-7	0: OFF 1: ON
					Bit7	SW3-8	0: OFF 1: ON
126	DIP SW [SW 4]	—	—	1	Bit0	SW4-1	0: OFF 1: ON
					Bit1	SW4-2	0: OFF 1: ON
					Bit2	SW4-3	0: OFF 1: ON
					Bit3	SW4-4	0: OFF 1: ON
					Bit4	SW4-5	0: OFF 1: ON
					Bit5	SW4-6	0: OFF 1: ON
					Bit6	SW4-7	0: OFF 1: ON
					Bit7	SW4-8	0: OFF 1: ON
127	DIP SW [SW 5]	—	—	1	Bit0	SW5-1	0: OFF 1: ON
					Bit1	SW5-2	0: OFF 1: ON
					Bit2	SW5-3	0: OFF 1: ON
					Bit3	SW5-4	0: OFF 1: ON
					Bit4	SW5-5	0: OFF 1: ON
					Bit5	SW5-6	0: OFF 1: ON
					Bit6	SW5-7	0: OFF 1: ON
					Bit7	SW5-8	0: OFF 1: ON
128	DIP SW [SW 6]	—	—	1	Bit0	SW6-1	0: OFF 1: ON
					Bit1	SW6-2	0: OFF 1: ON
					Bit2	SW6-3	0: OFF 1: ON
					Bit3	SW6-4	0: OFF 1: ON
					Bit4	SW6-5	0: OFF 1: ON
					Bit5	SW6-6	0: OFF 1: ON
					Bit6	SW6-7	0: OFF 1: ON
					Bit7	SW6-8	0: OFF 1: ON
129	Jumper SW	—	—	1	Bit0	J11	0: OFF 1: ON
					Bit1	J12	0: OFF 1: ON
					Bit2	J13	0: OFF 1: ON
					Bit3	J14	0: OFF 1: ON
					Bit4	J15	0: OFF 1: ON
					Bit5	J16	0: OFF 1: ON
130	Software SW	—	—	1	Bit0	Spare	
					Bit1	Spare	
					Bit2	Spare	
					Bit3	Outdoor fan snow protection control	

Code No.	Write-in contents	Record data					
		Data write-in range	Write-in unit	Number of bytes	Contents		
					Bit4	Spare	
					Bit5	Switching to heating wind temperature security priority	
131	Priority operation SW	0,1	—	1	0	First push priority	
					1	Last push priority	
132	Heating setting 1 (Target exit temperature)	40 – 50	1°C	1			
133	Heating setting 2 (Target of high temperature)	3.15 – 2.75	0.05MPa	1			
134	Heating setting 3 (Judgment temperature)	30 – 38	1°C	1			
135	CnS1 function assignment	0 – 9	—	1			
136	CnS2 function assignment	0 – 9	—	1			
137	CnG1 function assignment	0 – 9	—	1			
138	CnG2 function assignment	0 – 9	—	1			
139	External output function assignment function assignment	0 – 9	—	1			
140	State in check operation (User's operation, limited to 255 – 1→0 only)	0 – 255	—	1			
141	Spare						

(2) Outdoor PCB setting

Code	Input	Remarks
SW1	Outdoor address No. (Order of 10)	
SW2	Outdoor address No. (Order of 1)	
SW3-1	Inspection LED reset Normal★/Reset	
SW3-2	Auto backup operation None★/With	
SW3-5	Check operation start Normal★/Check	
SW3-7	Forced cooling/heating Normal★/Forced cooling-heating	
SW5-1	Test run SW Normal★/Test run	
SW5-2	Test run mode Heating★/Cooling	
SW5-3	Pump down SW Normal★/Pump down	
SW5-4	Heat recovery selection	Keep ON
SW5-5	SL selector New SL (Auto)★/Old SL	
SW5-6	Spare	Keep OFF
SW5-7	Spare	Keep OFF
SW5-8	Spare	Keep OFF
SW6-3	High-COP combination selection	See following table
SW7	Data erase/write	
SW8	7-segment display code No. increasing (order of 1)	
SW9	7-segment display code No. increasing (order of 10)	
SW4-1	Model selection	See following table
SW4-2		
SW4-3		
SW4-4		
SW4-5	Spare	Keep OFF
SW4-6		
SW4-7	Master/slave unit setting address	See following table
SW4-8	Master/slave unit setting address	
J11	Power source voltage selection	
J12	Power source voltage selection	
J13	External input Level★/Pulse	
J14	Defrost reset temperature Normal★/Intensive	
J15	Defrost start temperature Normal★/Cold region	
J16	Spare	Keep OFF

Note (1) Jumper wires J13, J15 indicate short-circuit/open.

(2) Dip switch SW's indicate OFF/ON

(3) ★ indicates the factory setting (OFF).

■Model selection with SW4-1 SW4-4

0: OFF 1: ON

Model (HP)	224 (8)	280 (10)	335 (12)	400 (14)	450 (16)	475 (17)	500 (18)	560 (20)	615 (22)	670 (24)
SW4-1	0	1	0	0	1	1	0	1	0	0
SW4-2	0	0	1	0	0	1	1	1	0	1
SW4-3	0	0	0	1	1	0	1	1	1	1
SW4-4	0	0	0	0	0	0	0	0	1	1

■Model selection with SW4-1 SW4-4, SW6-3 (High-COP combination) 0: OFF 1: ON

Model (HP)	224 (8)	280 (10)	335 (12)
SW4-1	0	1	0
SW4-2	0	0	1
SW4-3	0	0	0
SW4-4	0	0	0
SW6-3	1	1	1

■Master/slave setting with SW4-7, SW4-8 0: OFF 1: ON

Outdoor unit	SW4-7	SW4-8
Master unit	0 ★	0 ★
Slave unit 1	1	0
Slave unit 2	0	1

(3) Indoor PCB setting

Code	Input	Default setting		Remarks
SW1	Indoor unit address No.(Order of 10)	0		0-9
SW2	Indoor unit address No.(Order of 1)	0		0-9
SW3	Outdoor unit address No.(Order of 10)	4		0-9
SW4	Outdoor unit address No.(Order of 1)	9		0-9
SW5-1	Superlink selection	Automatic*/Previous SL	OFF	Automatic
SW5-2	Indoor unit address No.(Order of 100)	OFF	0	OFF : 0, ON : 1
SW6-1	Model selection	As per model		See table 1
SW6-2				
SW6-3				
SW6-4				
SW8-1				
SW7-1	Test run, Drain motor	Normal*/Test run	OFF	Normal
SW7-2	Reserved		OFF	keep OFF
SW7-3	Spare		OFF	keep OFF
SW7-4	Reserved		OFF	keep OFF
JSL1	Superlink terminal spare	Normal*/switch to spare	With	Normal

* Default setting

■Model selection with SW6-1 - SW6-4 and SW8-1

0 : OFF 1 : ON

	P15	P22	P28	P36	P45	P56	P71	P90	P112	P140	P160	P224	P280
SW6-1	0	0	1	0	0	0	0	0	1	0	1	0	1
SW6-2	0	0	0	1	0	1	0	1	1	0	0	1	1
SW6-3	0	0	0	0	1	1	0	0	0	1	1	1	1
SW6-4	0	0	0	0	0	0	1	1	1	1	1	1	1
SW8-1	1	0	0	0	0	0	0	0	0	0	0	0	0

2. SYSTEM TROUBLESHOOTING PROCEDURE

2.1 Basics of troubleshooting

Basic troubleshooting is to check/analyze/save data by connecting the Mente PC.

Whenever arriving at the site, always connect the Mente PC before starting work.

Method of error data analysis (Basic procedure)

- Identify whether particular error occurred during operation or stopping.
- Is it caused by the installation conditions of outdoor/indoor unit? (Refrigerant quantity, pipe length, short-circuit, clogged filter, etc.)
- Isn't there any beginner's mistake at the installation? (Wrong address, mistake in piping or wiring, etc.)
- Is the failure related to any hardware (parts)? (SV main body, coil, capillary, check valve, sensor, etc.)
- Is it a major component?
Compressor, inverter PCB and outdoor DC fan motor
- Is it a failure of electrical component

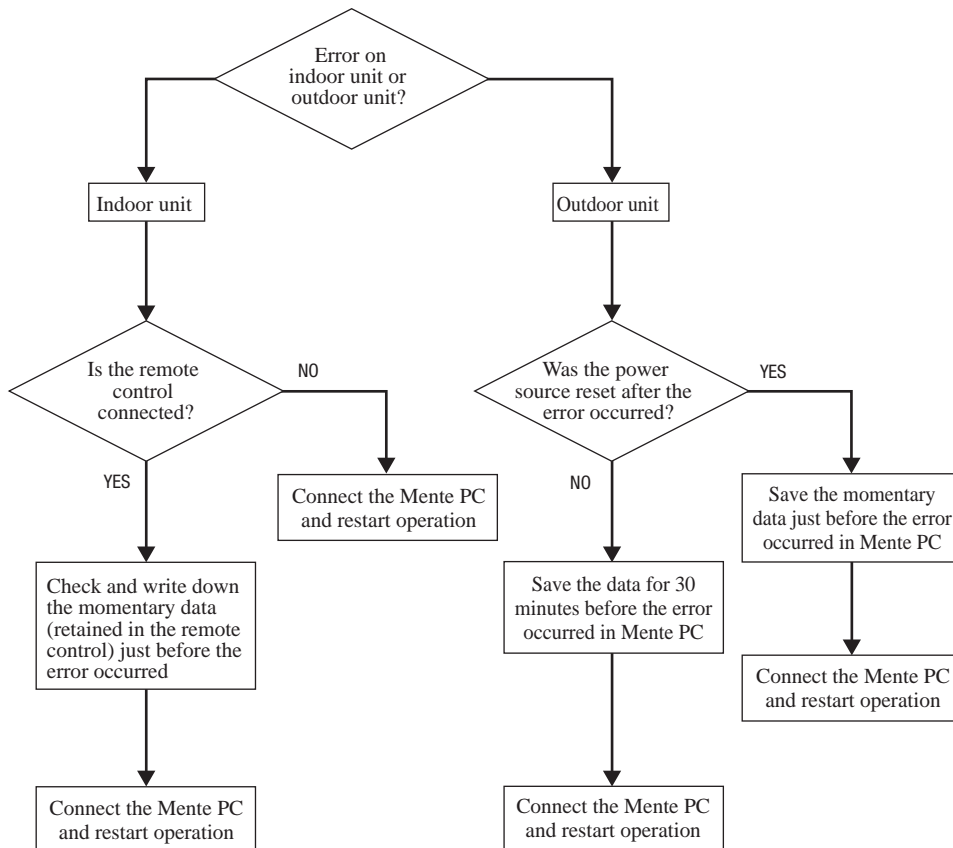

2.2 Explanation of troubleshooting

(a) Checking DC15V on the control PCB (Step to check if the inverter PCB fails or not)

Use this to diagnose E41, E42, E45 and E48.

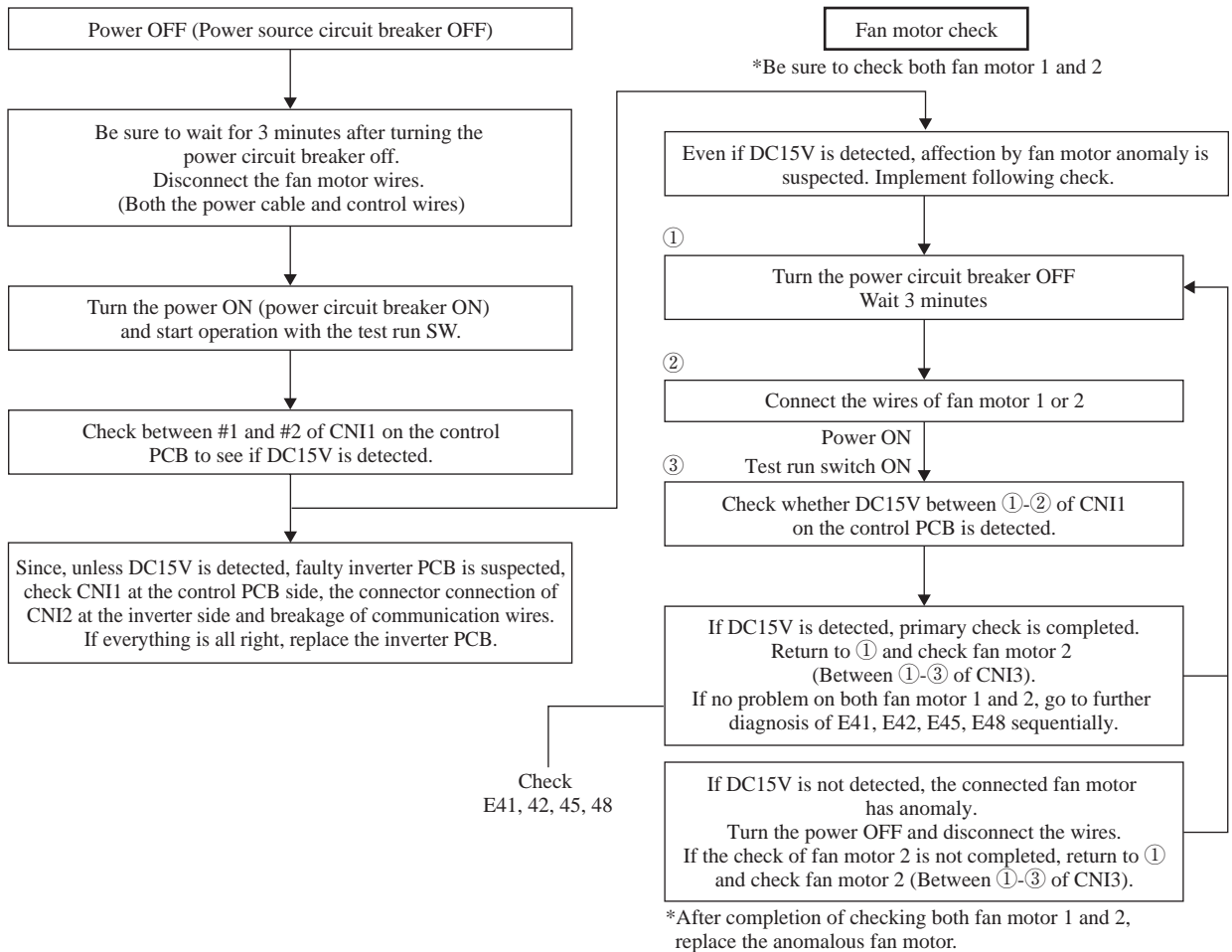

(b) Inspection of short-circuit on the power transistor module terminals

Disconnect the wiring of compressor and check for short-circuit with a tester.

Inspect between terminals of: P-U, P-V, P-W, N-U, N-V, N-W and P-N

It will be easier to contact the tester at the following place at each terminal.

P: P terminal of power transistor

N: N terminal of power transistor

U: End of red harness to compressor

V: End of white harness to compressor

W: End of blue harness to compressor

Terminal (+)	Terminal (--)	Normal value (Ω)	
P	N	About 1M	Several 10 M
N	P	About 300-400	Several M
P	U	0	Several 10 M
P	V		
P	W	About 1.2M	Several 100K
N	U		
N	V		
N	W	About 1.3M	Several 100K
U	P		
V	P		
W	P	0	Several 10 M
U	N		
V	N		
W	N		

Note (1) When a measured value is 0 – a few kΩ, the element may be broken. Replace the power transistor part.

2.3 Contents of troubleshooting

(a) List of inspection displays

1) Indoor and outdoor units

Remote control error code	7-segment display	Name of inspection	Classification	Page
E1	–	Remote control communication error	Communication error	90
E2	–	Duplicated indoor unit address	Address setting error	91
E3	–	Outdoor unit signal line error	Address pairing setting error	92
E5	–	Communication error during operation	Communication error	93
E6	–	Indoor heat exchanger temperature thermistor anomaly (Thi-R)	Thermistor wire breakage	94
E7	–	Indoor return air temperature thermistor anomaly (Thi-A)	Thermistor wire breakage	95
E9	–	Drain trouble	System error	96
E10	–	Excessive number of indoor units (more than 17 units) by controlling one remote control	Communication error	97
E11	–	Address setting error between master and slave indoor units	Address setting error	98
E12	–	Address setting error by mixed setting method	Address setting error	99
E16	–	Indoor DC fan motor anomaly	DC fan motor error	100
E18	–	Address setting error of master and slave indoor units	Address setting error	101
E19	–	Indoor unit operation check drain motor check mode anomaly	Setting error	102
E20	–	Indoor DC fan motor rotation speed anomaly	DC fan motor error	103
E21	–	Detective panel switch operation (FDT)	Panel switch error	104
E28	–	Remote control temperature thermistor anomaly (The)	Thermistor wire breakage	105
E31	E31	Duplicated outdoor unit address No.	Address setting error	106
E32	E32	Open L3 Phase on power source at primary side	Site setting error	107
E36	E36-1, 2	Discharge pipe temperature error (Tho-D1, D2)	System error	108
E37	E37-1, 2 E37-4, 5 E37-5, 6 E37-8, 9	Outdoor heat exchanger temperature thermistor (Tho-R) and subcooling coil temperature thermistor (Tho-SC, -H) anomaly	Thermistor wire breakage	109
E38	E38	Outdoor air temperature thermistor anomaly (Tho-A)	Thermistor wire breakage	110
E39	E39-1, 2	Discharge pipe temperature thermistor anomaly (Tho-D1, D2)	Thermistor wire breakage	111
E40	E40	High pressure anomaly (63H1-1, 2 activated)	System error	112
E41 (E51)	E41 (E51)-1, 2	Power transistor overheat	System error	113
E42	E42-1, 2	Current cut (CM1, 2)	System error	114
E43	E43-1 E43-2	Excessive number of indoor units connected, excessive total capacity of connection	Site setting error	115
E44	E44-1, 2	Liquid flooding anomaly (CM1,2)	System error	116
E45	E45-1, 2	Communication error between inverter PCB and outdoor unit control PCB	Communication error	117, 118
E46	E46	Mixed address setting methods coexistent in same network	Address setting error	119
E48	E48-1 E48-2	Outdoor DC fan motor anomaly	DC fan motor error	120, 121
E49	E49	Low pressure anomaly	System error	122
E53/E55	E53/E55-1, 2	Suction pipe temperature thermistor anomaly (Tho-S), Under-dome temperature thermistor anomaly (Tho-C1, C2)	Thermistor wire breakage	123
E54	E54-1 E54-2	High pressure sensor anomaly (PSH) Low pressure sensor anomaly (PSL)	Sensor wire breakage	124
E56	E56-1, 2	Power transistor temperature thermistor anomaly (Tho-P1, Tho-P2)	Thermistor wire breakage	125
E58	E58-1, 2	Anomalous compressor by loss of synchronism	System error	126
E59	E59-1, 2	Compressor startup failure (CM1, 2)	System error	127
E61	E61-1, 2	Communication error between the master unit and slave units	System error	128
E63	E63	Emergency stop	Site setting error	129

(b) Troubleshooting

Error code Remote control: None 7-segment display: -	LED	Green	Red	Content Operates but does not cool
	Indoor	Keeps flashing	Stays OFF	
	Outdoor	Keeps flashing	Stays OFF	

1. Applicable model
All models

2. Error detection method

3. Condition of error displayed

4. Presumable cause
<ul style="list-style-type: none"> Poor compression of compressor Expansion valve operation anomaly

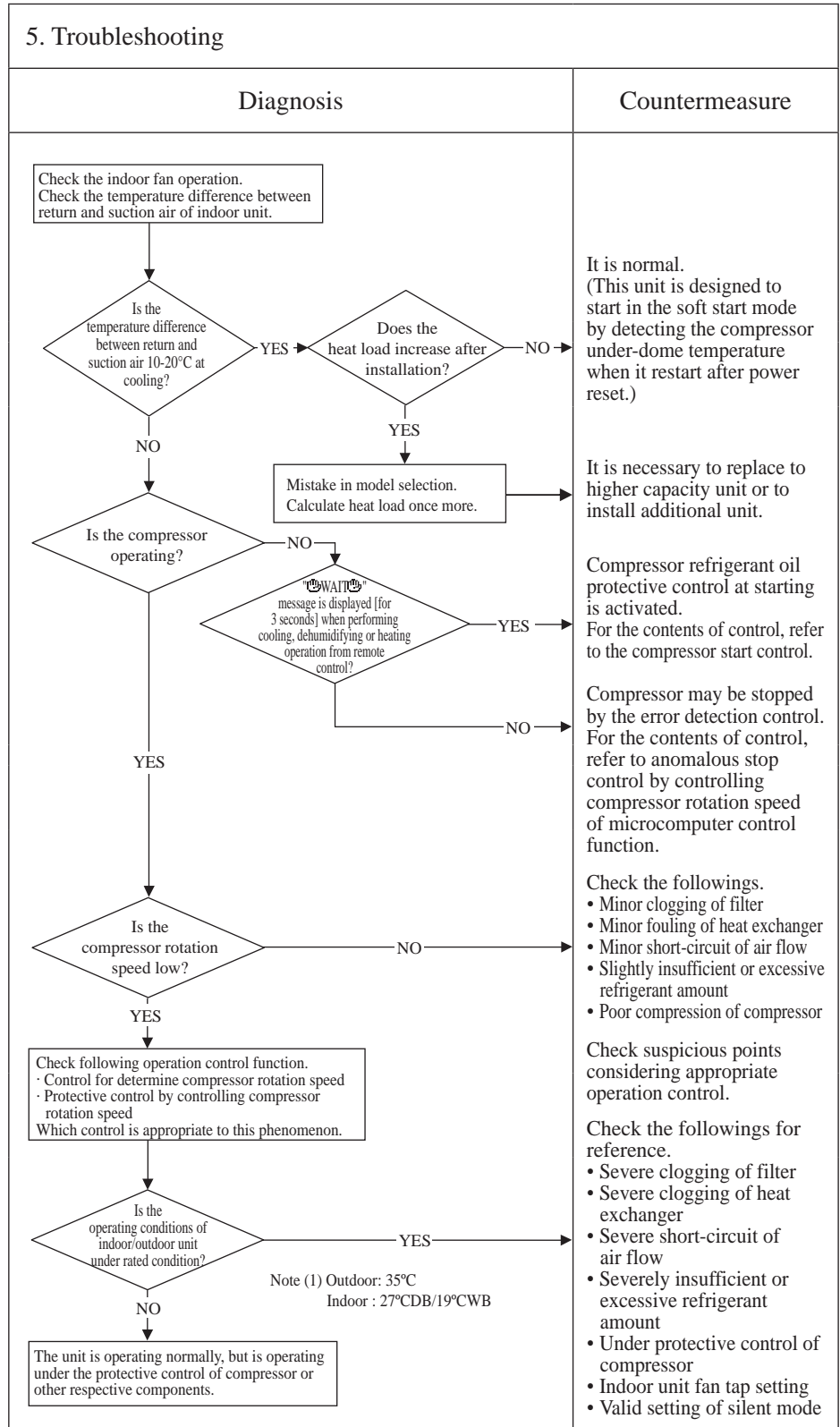

Note:

Error code Remote control:None 7-segment display: -	LED	Green	Red	Content Operates but does not heat
	Indoor	Keeps flashing	Stays OFF	
	Outdoor	Keeps flashing	Stays OFF	

1.Applicable model
All models
2.Error detection method
3. Condition of error displayed
4.Presumable cause
<ul style="list-style-type: none"> • 4-way valve anomaly • Poor compression of compressor • Expansion valve anomaly operation

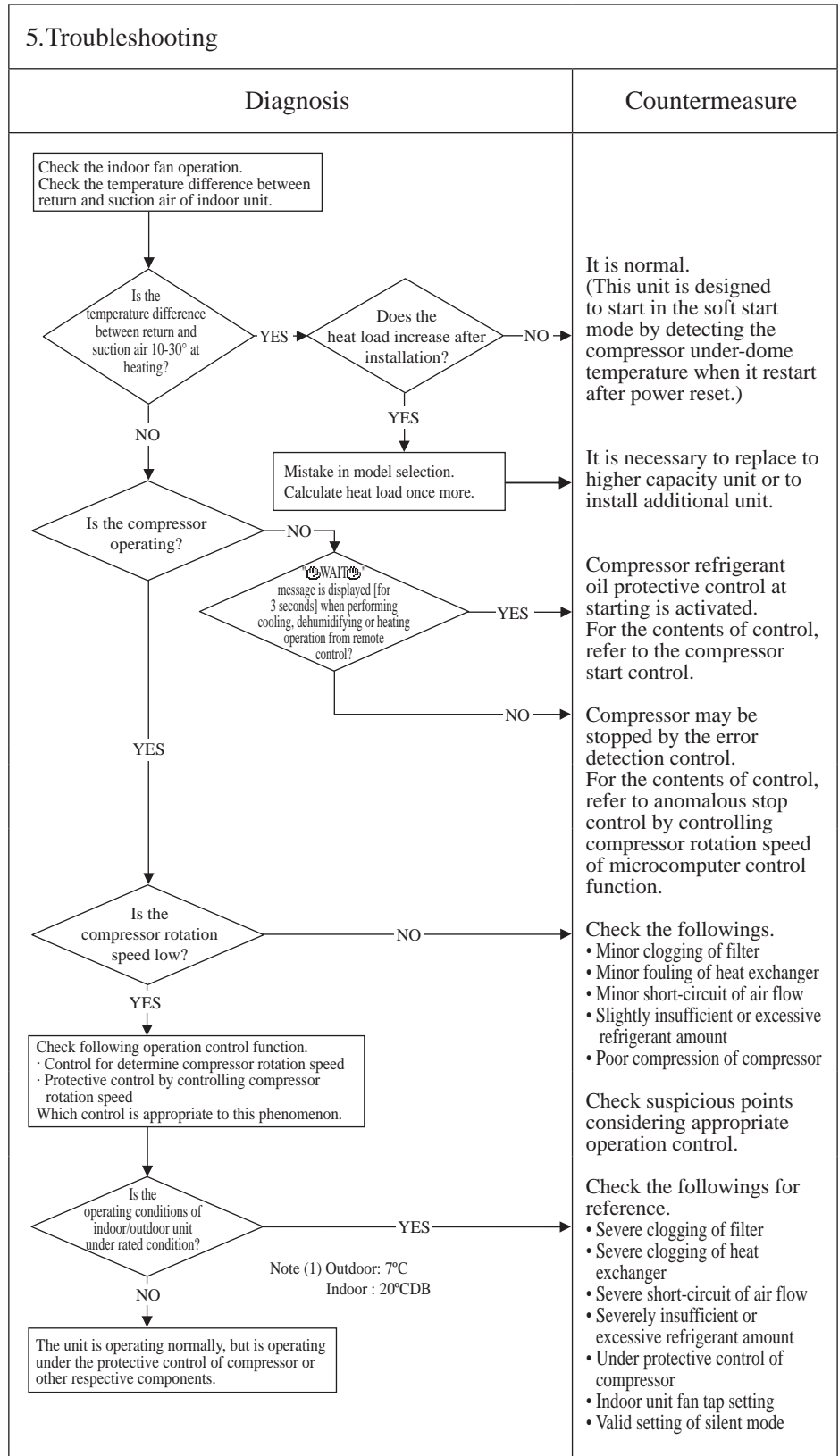

Note:

Error code Remote control: None 7-segment display: –	LED	Green	Red	Content <h2 style="text-align: center;">Earth leakage breaker activated</h2>
	Indoor	Stays OFF	Stays OFF	
	Outdoor	Stays OFF	Stays OFF	

<h3>1. Applicable model</h3> <p>All models</p>	<h3>5. Troubleshooting</h3>	
<h3>2. Error detection method</h3>	<h4>Diagnosis</h4> <pre> graph TD D1{Are the insulation resistance and coil resistance of compressor OK?} -- NO --> C1[Replace compressor.*] D1 -- YES --> D2{Is insulation of respective harnesses OK?} D2 -- NO --> C2[Secure insulation resistance.] D2 -- YES --> D3{Is any harness bitten between panel and casing or etc?} D3 -- YES --> C3[Secure insulation resistance.] D3 -- NO --> P1[Check the outdoor unit grounding wire and earth leakage breaker.] </pre>	<h4>Countermeasure</h4>
<h3>3. Condition of error displayed</h3>	<div style="border: 1px solid black; padding: 5px;"> <p>Check of the outdoor unit grounding wire and earth leakage breaker</p> <p>① Run an independent grounding wire from the grounding screw of outdoor unit to the grounding terminal on the distribution panel. (Do not connect to another grounding wire.)</p> <p>② In order to prevent malfunction of the earth leakage breaker itself, confirm the conformity of high harmonic regulation.</p> <p>* Insulation resistance of compressor</p> <ul style="list-style-type: none"> Immediately after installation or when the unit has been left for long period without power source, the insulation resistance may drop to a few MΩ because of refrigerant migrated in the compressor. <p>When the earth leakage breaker is activated at lower insulation resistance, check the following points.</p> <p>① 6 hours after power ON, check if the insulation resistance recovers to normal.</p> <p>When power ON, crankcase heater heat up compressor and evaporates the refrigerant migrated in the compressor.</p> <p>② Check if the earth leakage breaker is conformed to higher harmonic regulation or not.</p> <p>Since the unit has inverter, it is necessary to use components conformed to high harmonic regulation in order to prevent malfunction of earth leakage breaker.</p> </div>	
<h3>4. Presumable cause</h3> <ul style="list-style-type: none"> Compressor anomaly Noise 		

Note:

Error code Remote control:None 7-segment display: -	LED	Green	Red	Content Excessive noise/vibration (1/3)
	Indoor	-	-	
	Outdoor	-	-	

1.Applicable model
All models

2.Error detection method

3. Condition of error displayed

- 4.Presumable cause**
- ① Improper installation work
 - Improper vibration-proof work at installation
 - Insufficient strength of mounting surface
 - ② Anomaly of product
 - Before/after shipment from factory
 - ③ Improper adjustment during commissioning
 - Excessive/insufficient refrigerant.

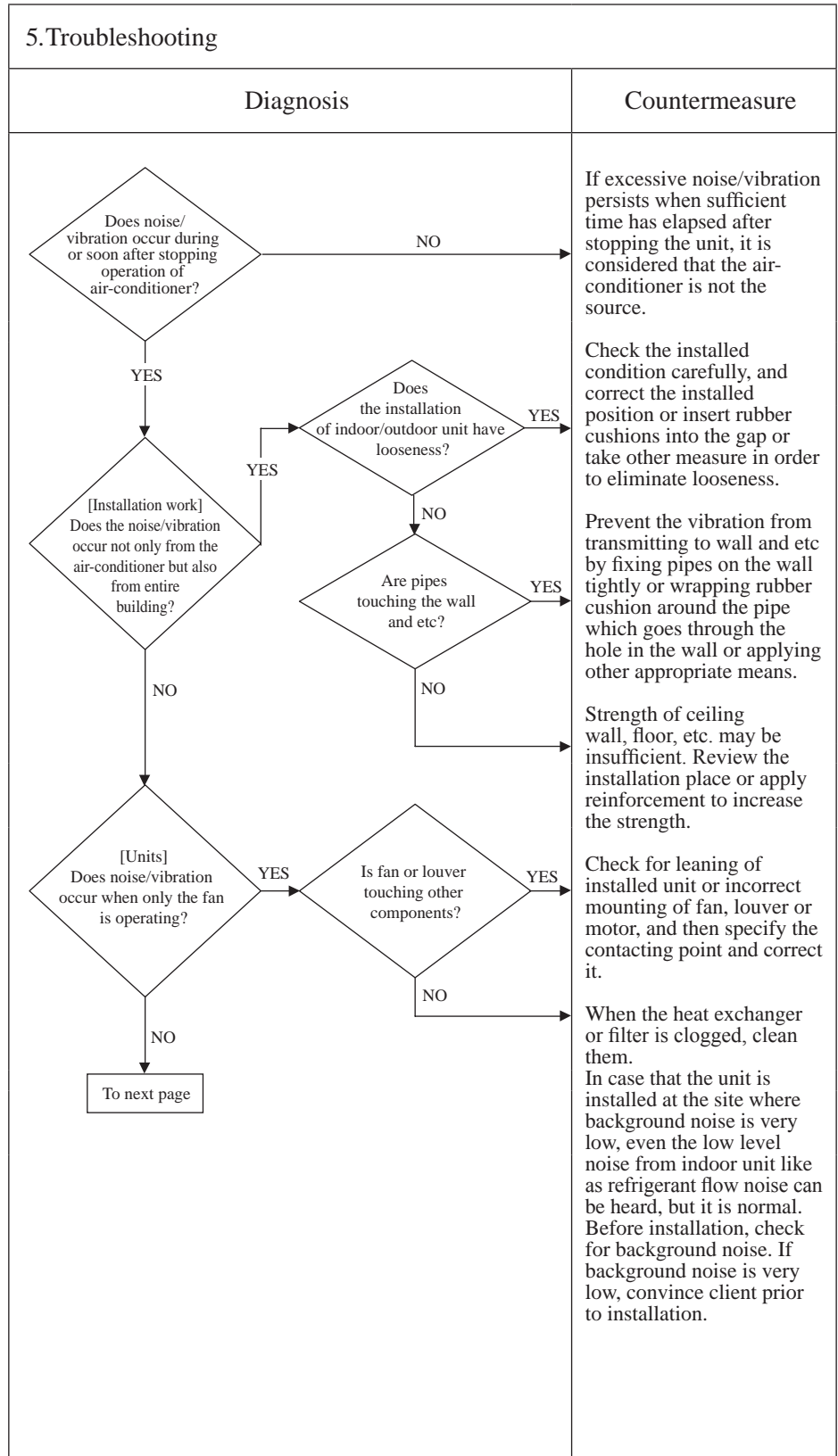

Note:

Error code Remote control:None 7-segment display: –	LED	Green	Red	Content <h2 style="text-align: center;">Excessive noise/vibration (2/3)</h2>
	Indoor	–	–	
	Outdoor	–	–	

1.Applicable model All models
2.Error detection method
3. Condition of error displayed
4.Presumable cause

5.Troubleshooting	
Diagnosis	Countermeasure
<pre> graph TD Start([From previous page]) --> Q1{[Unit] Does noise/vibration occur when the cooling/heating operation is performing normally?} Q1 -- NO --> Next([To next page]) Q1 -- YES --> Q2{Are the pipes contacting with the casing?} Q2 -- YES --> C1[Rearrange the piping to avoid contact with the casing.] Q2 -- NO --> Q3{Is continuous hissing or roaring sound occurred?} Q3 -- YES --> C2[Noise/vibration is generated when the refrigerant gas or liquid flows through inside of piping of air-conditioner. It is likely to occur particularly during cooling or defrosting in the heating mode. It is normal.] Q3 -- NO --> Q4{Is hissing sounds occurred at the startup or stopping?} Q4 -- YES --> C3[The noise/vibration occurs when the refrigerant starts or stops flowing. It is normal.] Q4 -- NO --> Q5{Is blowing sound occurred at the start/stop of defrost operation during heating mode?} Q5 -- YES --> C4[When the defrost operation starts or stops during heating mode, the refrigerant flow is reversed due to switching 4-way valve. This causes a large change in pressure which produces a blowing sound. It may also accompany the hissing sound as mentioned above. This is normal.] Q5 -- NO --> Q6{Is cracking noise occurred during heating operation?} Q6 -- YES --> C5[After the start or stop of heating operation or during defrost operation, abrupt changes in temperature cause resin parts to shrink or expand. This is normal.] Q6 -- NO --> Q7{Is hissing noise occurred during cooling operation or after operation stopped?} Q7 -- YES --> C6[It is the sound produced by the drain pump that discharges drain from indoor unit. The pump continues to run for 5 minutes after stopping the cooling operation. This is normal.] Q7 -- NO --> C7[Apply the damper sealant at the place considered to be the sources such as the pressure reducing mechanism. (Expansion valve, capillary tube, etc.)] </pre>	

Note:

Error code Remote control:None 7-segment display: -	LED	Green	Red	Content Excessive noise/vibration (3/3)
	Indoor	-	-	
	Outdoor	-	-	

1.Applicable model	5.Troubleshooting		
All models	Diagnosis	Countermeasure	
2.Error detection method	<pre> graph TD A[From previous page] --> B{[Adjustment during commissioning] Does noise/vibration occur when the cooling/heating operation is performed under anomalous condition?} B -- YES --> C[Countermeasure] </pre>		
3. Condition of error displayed	<p>If insufficient cooling/heating problem happens due to anomalous operating conditions at cooling/heating, followings are suspicious.</p> <ul style="list-style-type: none"> • Excessive charged amount of refrigerant • Insufficient charge amount of refrigerant • Intrusion of air, nitrogen, etc. <p>In such case, it is necessary to recover refrigerant, vacuum-dry and recharge refrigerant.</p> <p>* Since there could be many causes of noise/vibration, the above may not cover all. In such case, check the conditions when, where, how the noise/vibration occurs according to following check points and ask our consultation.</p> <ul style="list-style-type: none"> • Indoor/outdoor unit • Cooling/heating/fan mode • Startup/stop/during operation • Operating condition (Indoor/outdoor temperatures and pressures) • Time it occurred • Operation data retained by remote control or Mente PC such as compressor rotation speed, heat exchanger temperature, EEV opening degree and etc. • Tone (If available, record the noise) • Any other anomalies. 		
4.Presumable cause			

Note:

Error code Remote control: None 7-segment display: –	LED	Green	Red	Content <h2 style="text-align: center;">Louver motor failure</h2>
	Indoor	Keeps flashing	Stays OFF	
	Outdoor	Keeps flashing	Stays OFF	

1.Applicable model
All models

2.Error detection method

3. Condition of error displayed

4.Presumable cause
<ul style="list-style-type: none"> • Defective LM • LM wire breakage • Indoor unit control PCB anomaly

5.Troubleshooting	
Diagnosis	Countermeasure
<p>▲ Check at the indoor unit side.</p> <pre> graph TD Start[Operate after waiting for more than 1 minute.] --> Q1{Does the louver operate at the power on?} Q1 -- NO --> Q2{Is LM wiring broken?} Q2 -- YES --> C1[Repair wiring.] Q2 -- NO --> Q3{Is LM locked?} Q3 -- YES --> C2[Replace LM.] Q3 -- NO --> C3[Indoor unit control PCB anomaly → Replace it.] Q1 -- YES --> Q4{Is the louver operable with the remote control?} Q4 -- YES --> C4[Normal] Q4 -- NO --> C5[Replace louver motor. (If errors persist even after replacing the louver motor, replace the indoor unit control PCB.)] </pre> <p style="text-align: center;">LM: louver motor</p>	

Note:

Error code Remote control: None 7-segment display: -	LED	Green	Red	Content Power source system anomaly (Power source to indoor unit PCB)
	Indoor	Stays OFF	Stays OFF	
	Outdoor	Stays OFF	2-time flash	

1. Applicable model
FDT, FDK series only
2. Error detection method
3. Condition of error displayed
4. Presumable cause
<ul style="list-style-type: none"> • Wrong connection or breakage of connecting wires • Blown fuse • Transformer anomaly • Indoor unit PCB anomaly • Broken harness

5. Troubleshooting	
Diagnosis	Countermeasure
<pre> graph TD Q1{Is AC 220-240V detected between L-N on the indoor terminal block?} Q2{Is AC 380/415 V for 3-phase unit detected between L1, L2, and L3 on the outdoor terminal block respectively?} Q3{Are fuses OK?} Q4{Is resistance between ①-③ of CNW0 OK?} Q5{Is resistance to FM, LM and etc. OK?} Q6{Is DC280V detected between CNM FDT: ①-④, FDK: ①-③?} Q7{Is DC8V detected between CNP ①-②?} Q8{None of actuator, etc. is short-circuited?} Q9{Is JX1 open?} Q1 -- NO --> Q2 Q1 -- YES --> Q3 Q2 -- NO --> CM1[Outdoor noise filter PCB anomaly -> Replace it.] Q2 -- YES --> CM2[Wrong wiring or broken wires between outdoor and indoor units.] Q3 -- NO --> Q4 Q3 -- YES --> Q6 Q4 -- NO --> CM3[Indoor unit PCB anomaly -> Replace it.] Q4 -- YES --> Q5 Q5 -- YES --> CM4[Replace FM, LM and etc.] Q5 -- NO --> CM5[Replace fuse.] Q6 -- NO --> CM6[Indoor unit PCB anomaly -> Replace it.] Q6 -- YES --> Q7 Q7 -- NO --> Q8 Q7 -- YES --> Q9 Q8 -- NO --> CM7[Replace related parts.] Q8 -- YES --> CM8[Defective indoor unit PCB -> Replace.] Q9 -- NO --> CM9[Open JX1] Q9 -- YES --> CM10[Defective indoor unit PCB -> Replace.] </pre>	<p>Outdoor noise filter PCB anomaly → Replace it.</p> <p>Wrong wiring or broken wires between outdoor and indoor units.</p> <p>Indoor unit PCB anomaly → Replace it.</p> <p>Replace FM, LM and etc.</p> <p>Replace fuse.</p> <p>Indoor unit PCB anomaly → Replace it.</p> <p>Replace related parts.</p> <p>Defective indoor unit PCB → Replace.</p> <p>Open JX1</p> <p>Defective indoor unit PCB → Replace.</p>

Note:

Error code Remote control: None 7-segment display: -	LED	Green	Red	Content Power source system anomaly (Power source to indoor unit PCB)
	Indoor	Stays OFF	Stays OFF	
	Outdoor	Stays OFF	2-time flash	

1. Applicable model
Except FDT, FDK series
2. Error detection method
3. Condition of error displayed
4. Presumable cause
<ul style="list-style-type: none"> • Wrong connection or breakage of connecting wires • Blown fuse • Transformer anomaly • Indoor unit power PCB anomaly • Broken harness • Indoor unit control PCB anomaly

5. Troubleshooting	
Diagnosis	Countermeasure

Note:

Error code Remote control:None 7-segment display: –	LED	Green	Red	Content Power source system error (Power source to remote control)
	Indoor	Keeps flashing	Stays OFF	
	Outdoor	Keeps flashing	2-time flash	

1.Applicable model
 FDT, FDK series only

2.Error detection method

3. Condition of error displayed

- 4.Presumable cause**
- Remote control wire breakage/short-circuit
 - Defective remote control
 - Malfunction by noise
 - Broken harness
 - Faulty indoor unit control PCB

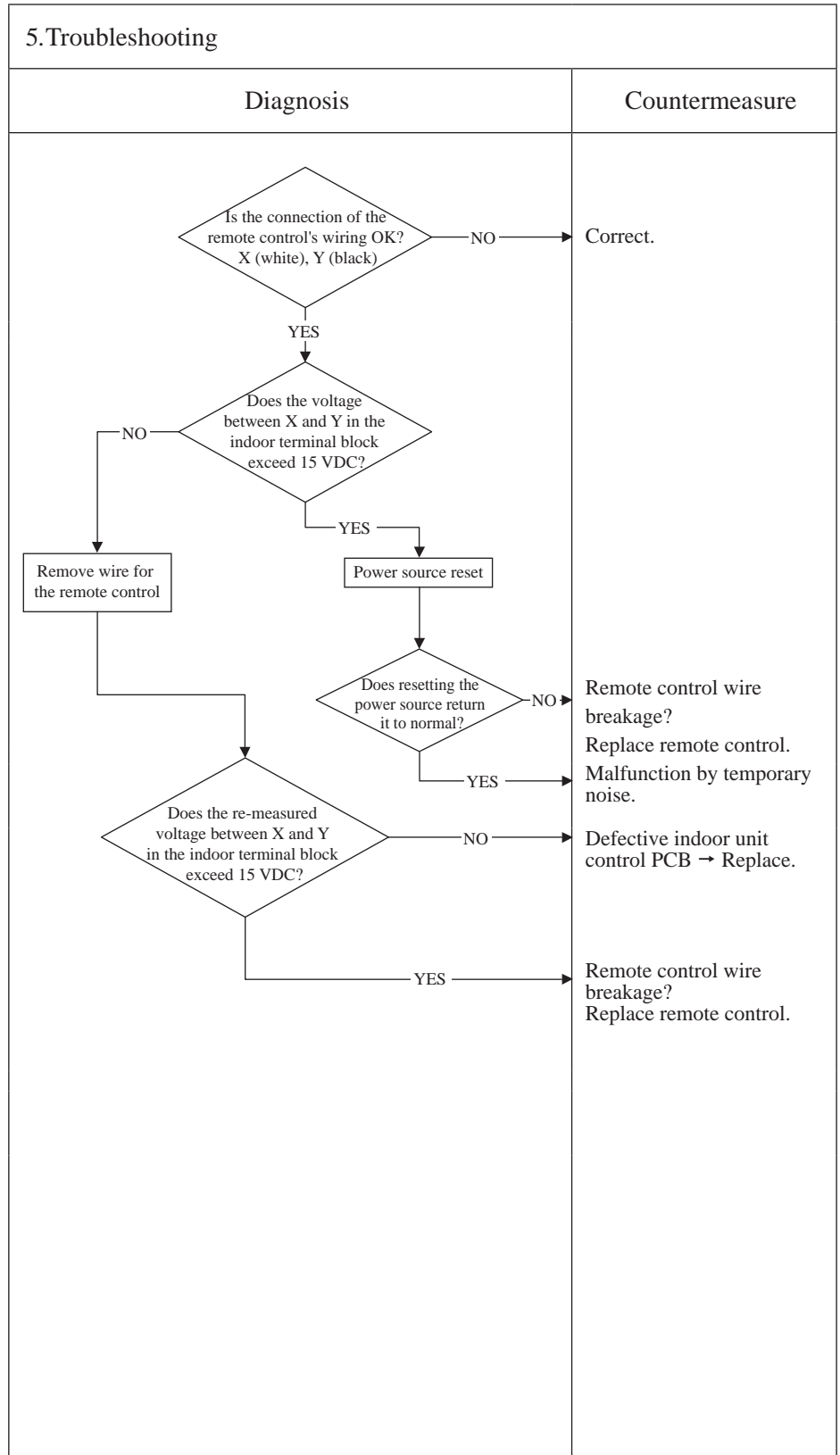

Note:

Error code Remote control:None 7-segment display: –	LED	Green	Red	Content Power source system error (Power source to remote control)
	Indoor	Keeps lighting	Stays OFF	
	Outdoor	Keeps lighting	2-time flash	

1.Applicable model
Except FDT, FDK series
2.Error detection method
3. Condition of error displayed
4.Presumable cause
<ul style="list-style-type: none"> • Remote control wire breakage/short-circuit • Remote control anomaly • Malfunction by noise • Indoor unit power PCB anomaly • Broken harness • Indoor unit control PCB anomaly

5.Troubleshooting	
Diagnosis	Countermeasure
<pre> graph TD Q1{Isn't there any loose connection of remote control wires?} -- YES --> C1[Correct it.] Q1 -- NO --> Q2{Isn't remote control wire broken or short-circuited?} Q2 -- YES --> C2[Replace wires.] Q2 -- NO --> R1[Disconnect the remote control wires.] R1 --> Q3{Is DC15V or higher detected between X-Y of indoor unit terminal block?} Q3 -- YES --> C3[Replace remote control.] Q3 -- NO --> S1{Model equipped with transformer (Tr I)} S1 --> Q4{Is 23V or higher detected between Brown-Brown at the transformer secondary side?} S2{Models other than shown at left} --> Q5{Is DC18V detected between ①-② of CNW2?} Q5 -- NO --> C4[Indoor unit power PCB anomaly → Replace it.] Q5 -- YES --> C5[Indoor unit control PCB anomaly → Replace it.] Q4 -- NO --> C6[Replace transformer.] Q4 -- YES --> C7[Indoor unit control PCB anomaly → Replace it.] </pre>	

Note:

Error code Remote control: 🏠WAIT🏠 7-segment display: -	LED	Green	Red	Content 🏠WAIT🏠 (1)
	Indoor	Keeps flashing	Stays OFF	
	Outdoor	Keeps flashing	Keeps flashing	

1.Applicable model

All models

(In case that 🏠WAIT🏠 is kept on displaying on the remote control for more than 2 minutes after power ON.)

2.Error detection method

3. Condition of error displayed

- 4.Presumable cause**
- Fuse blown
 - Noise filter anomaly
 - Anomalous connection of wire between PCBs
 - Indoor unit control PCB anomaly
 - Remote control anomaly
 - Breakage of connecting wires of remote control
 - Outdoor unit control PCB anomaly

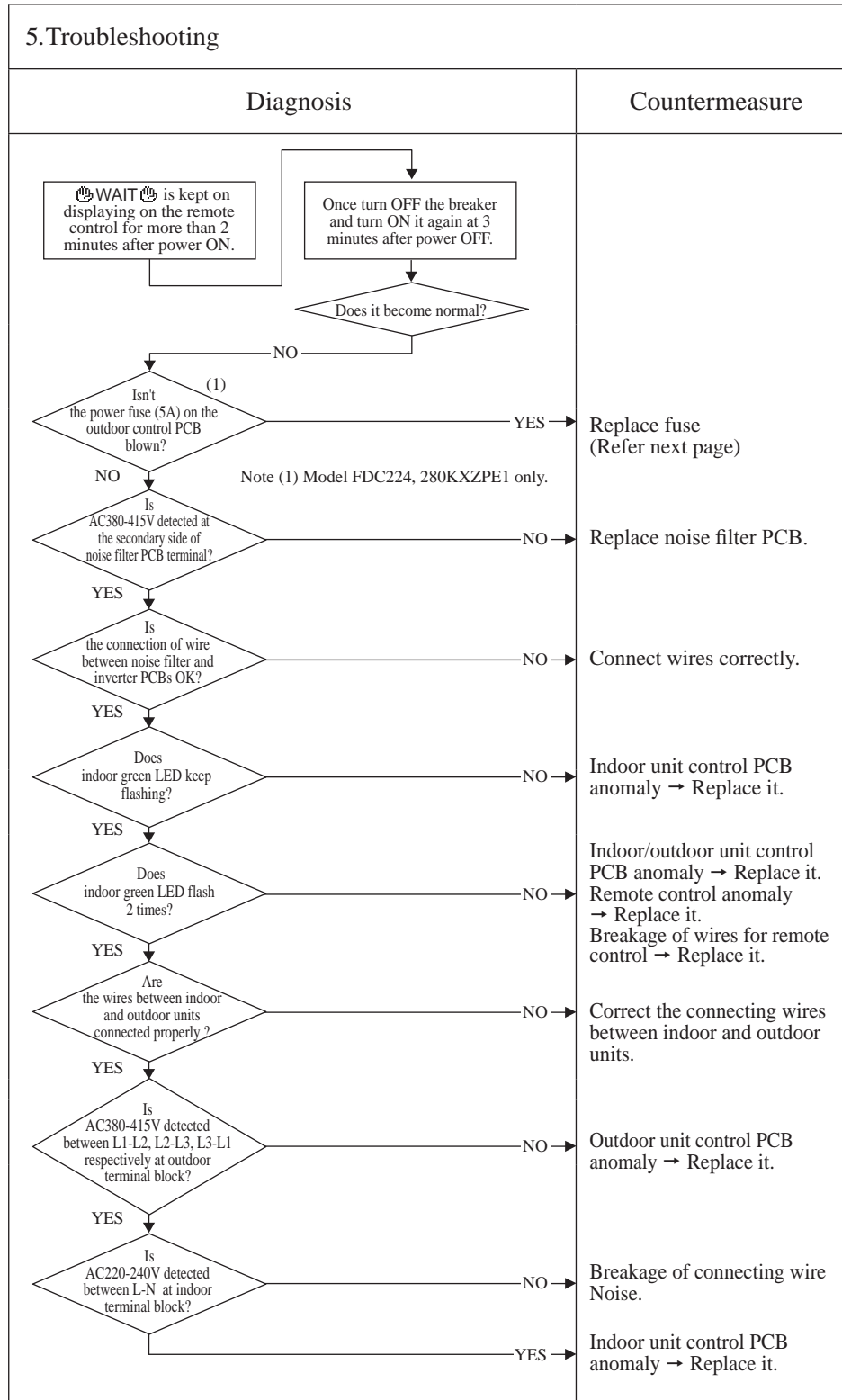

Note: (1) When anomaly occurs during establishing communication between indoor and outdoor unit, error code E5 is displayed (outdoor red LED flash 2-times).
 In case of E5, the way of troubleshooting is same as above mentioned (except for checking of connecting wire).
 When reset the power after E5 occurs, if this anomaly recurs, 🏠WAIT🏠 is displayed on remote control. If power ON/OFF is repeated in a short period (within 1 minute), 🏠WAIT🏠 may be displayed. In such case, please wait for 3 minute after the power breaker OFF.
 (2) If any error is detected 30 minutes after displaying “🏠WAIT🏠” on the remote control, the display changes to “INSPECT I/U”.

Error code Remote control: WAIT 7-segment display: -	LED	Green	Red	Content WAIT (2)
	Indoor	Keeps flashing	Stays OFF	
	Outdoor	Keeps flashing	Keeps flashing	

<p>1. Applicable model</p> <p>All models</p> <p>(In case of fuse blown, how to check the unit before replacement of fuse.)</p>	5. Troubleshooting	
<p>2. Error detection method</p>	Diagnosis	Countermeasure
<p>3. Condition of error displayed</p>	<pre> graph TD D1{Isn't there any short circuit between phases of noise filter?} A1[Replace noise filter] D2{Isn't there any crack or damage on power transistor module or diode stack?} A2[Replace inverter PCB] D3{Isn't there any anomaly on reactor?} A3[Replace reactor] CM[Replace fuse.] D1 -- YES --> A1 D1 -- NO --> D2 D2 -- YES --> A2 D2 -- NO --> D3 D3 -- YES --> A3 D3 -- NO --> CM </pre>	
<p>4. Presumable cause</p> <ul style="list-style-type: none"> • Fuse blown • Noise filter anomaly • Anomalous connection of wire between PCBs • Indoor unit control PCB anomaly • Remote control anomaly • Breakage of connecting wires of remote control • Outdoor unit control PCB anomaly 		

Note:

Error code Remote control: WAIT 7-segment display: -	LED	Green	Red	Content	WAIT (3)
	Indoor	Keeps flashing	Stays OFF		
	Outdoor	Keeps flashing	Keeps flashing		

1.Applicable model
All models (No display on the remote control after power ON.)

2.Error detection method

3. Condition of error displayed

4.Presumable cause
<ul style="list-style-type: none"> • Fuse blown • Noise filter anomaly • Anomalous connection of wire between PCBs • Indoor unit control PCB anomaly • Remote control anomaly • Breakage of connecting wires of remote control • Outdoor unit control PCB anomaly

5.Troubleshooting	
Diagnosis	Countermeasure
<pre> graph TD Start[No display on the remote control after power ON.] --> Q1{Does indoor green LED keep flashing?} Q1 -- NO --> Q2{Is the fuse on indoor unit control PCB OK?} Q2 -- NO --> C1[Fuse blown → Replace fuse.] Q2 -- YES --> Q3{Is AC18V or higher detected between Red-Red at secondary side of indoor transformer? (1)} Q3 -- NO --> C2[Transformer anomaly.] Q3 -- YES --> Q4{Is DC10-11V between X-Y at indoor unit control PCB side when removing remote control?} Q4 -- NO --> C3[Remote control wire short-circuited.] Q4 -- YES --> C4[Remote control anomaly.] Q1 -- YES --> Q5{Does outdoor red LED flash 2-times?} Q5 -- NO --> C5[Indoor unit control PCB anomaly. Remote control anomaly. Breakage of connecting wires of remote control.] Q5 -- YES --> Q6{Is the connecting wires between indoor and outdoor units connected properly?} Q6 -- NO --> C6[Correct the connecting wires properly.] Q6 -- YES --> Q7{Is AC380-415V detected between L1-L2, L2-L3, L3-L1 respectively at outdoor terminal block?} Q7 -- NO --> C7[Outdoor unit control PCB anomaly → Replace it.] Q7 -- YES --> Q8{Is AC220-240V detected between L-N at indoor terminal block?} Q8 -- NO --> C8[Breakage of connecting wire Noise.] Q8 -- YES --> C9[Indoor unit control PCB anomaly → Replace it.] </pre>	<p>Fuse blown → Replace fuse.</p> <p>Transformer anomaly.</p> <p>Remote control wire short-circuited.</p> <p>Remote control anomaly.</p> <p>Indoor unit control PCB anomaly. Remote control anomaly. Breakage of connecting wires of remote control.</p> <p>Correct the connecting wires properly.</p> <p>Outdoor unit control PCB anomaly → Replace it.</p> <p>Breakage of connecting wire Noise.</p> <p>Indoor unit control PCB anomaly → Replace it.</p>

Note:

Error code Remote control: WAIT 7-segment display: -	LED	Green	Red	Content
	Indoor	Keeps flashing	Stays OFF	
	Outdoor	Keeps flashing	Keeps flashing	

WAIT (4)

1. Applicable model

All models

(In case that WAIT is kept on displaying on the remote control for more than 2 minutes after power ON.)

2. Error detection method

3. Condition of error displayed

- 4. Presumable cause**
- Fuse blown
 - Noise filter anomaly
 - Anomalous connection of wire between PCBs
 - Indoor unit control PCB anomaly
 - Remote control anomaly
 - Breakage of connecting wires of remote control
 - Outdoor unit control PCB anomaly

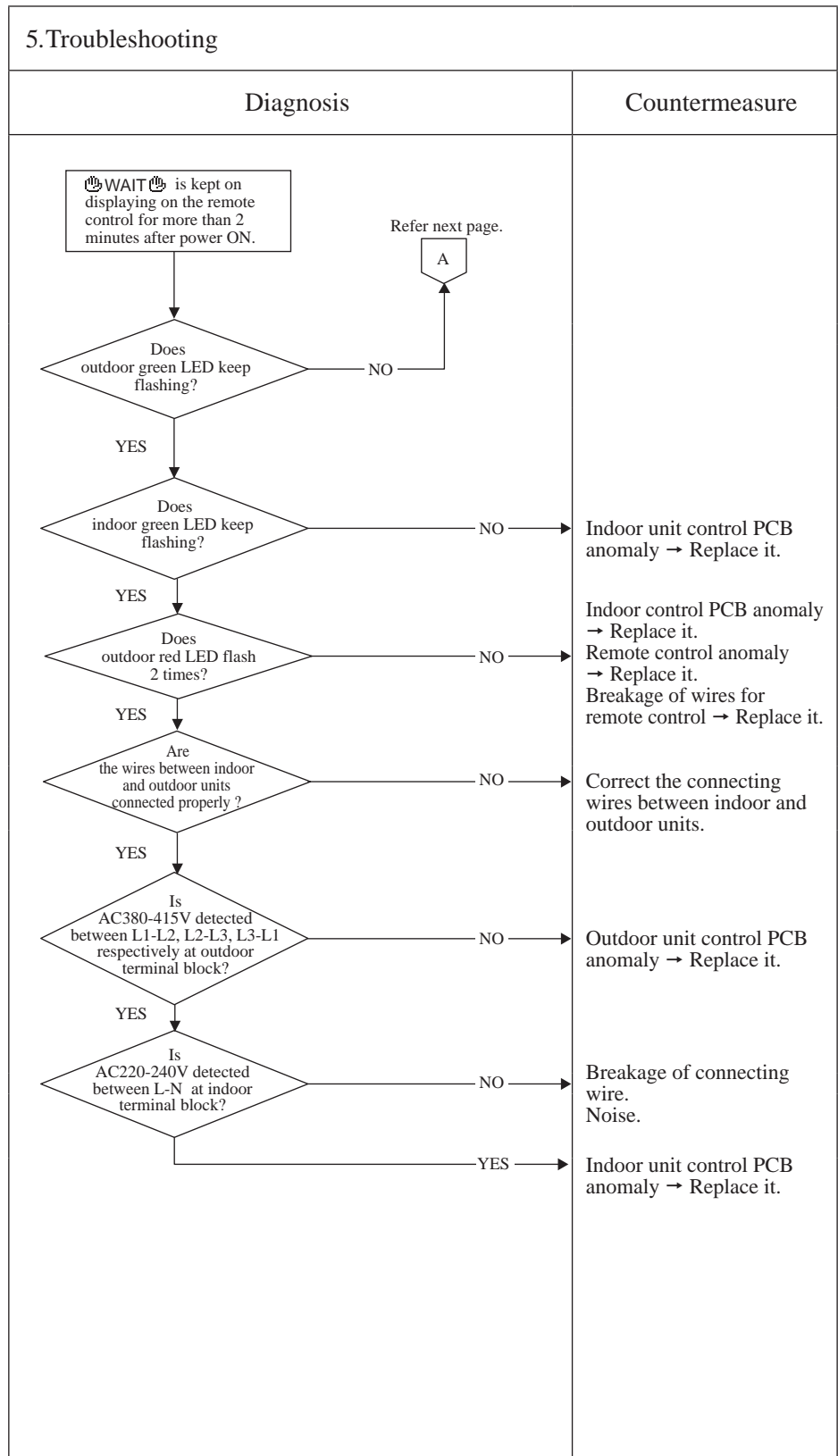

Note:

Error code Remote control: WAIT 7-segment display: -	LED	Green	Red	Content
	Indoor	Stays OFF	Stays OFF	
	Outdoor	Stays OFF	Stays OFF	

WAIT (5)

1. Applicable model All models (In case that LED on outdoor control PCB stays OFF.)
2. Error detection method
3. Condition of error displayed
4. Presumable cause <ul style="list-style-type: none"> • Fuse blown • Noise filter anomaly • Anomalous connection of wire between PCBs • Indoor unit control PCB anomaly • Remote control anomaly • Breakage of connecting wires of remote control • Outdoor unit control PCB anomaly

5. Troubleshooting	
Diagnosis	Countermeasure
In case that LED on outdoor control PCB stays OFF. From previous page.	

Note:

Error code Remote control: WAIT 7-segment display: -	LED	Green	Red	Content WAIT (6)
	Indoor	Stays OFF	Stays OFF	
	Outdoor	Stays OFF	Stays OFF	

1. Applicable model

All models

(In case of fuse blown, how to check the unit before replacement of fuse.)

2. Error detection method

3. Condition of error displayed

- 4. Presumable cause**
- Fuse blown
 - Noise filter anomaly
 - Anomalous connection of wire between PCBs
 - Indoor unit control PCB anomaly
 - Remote control anomaly
 - Breakage of connecting wires of remote control
 - Outdoor unit control PCB anomaly

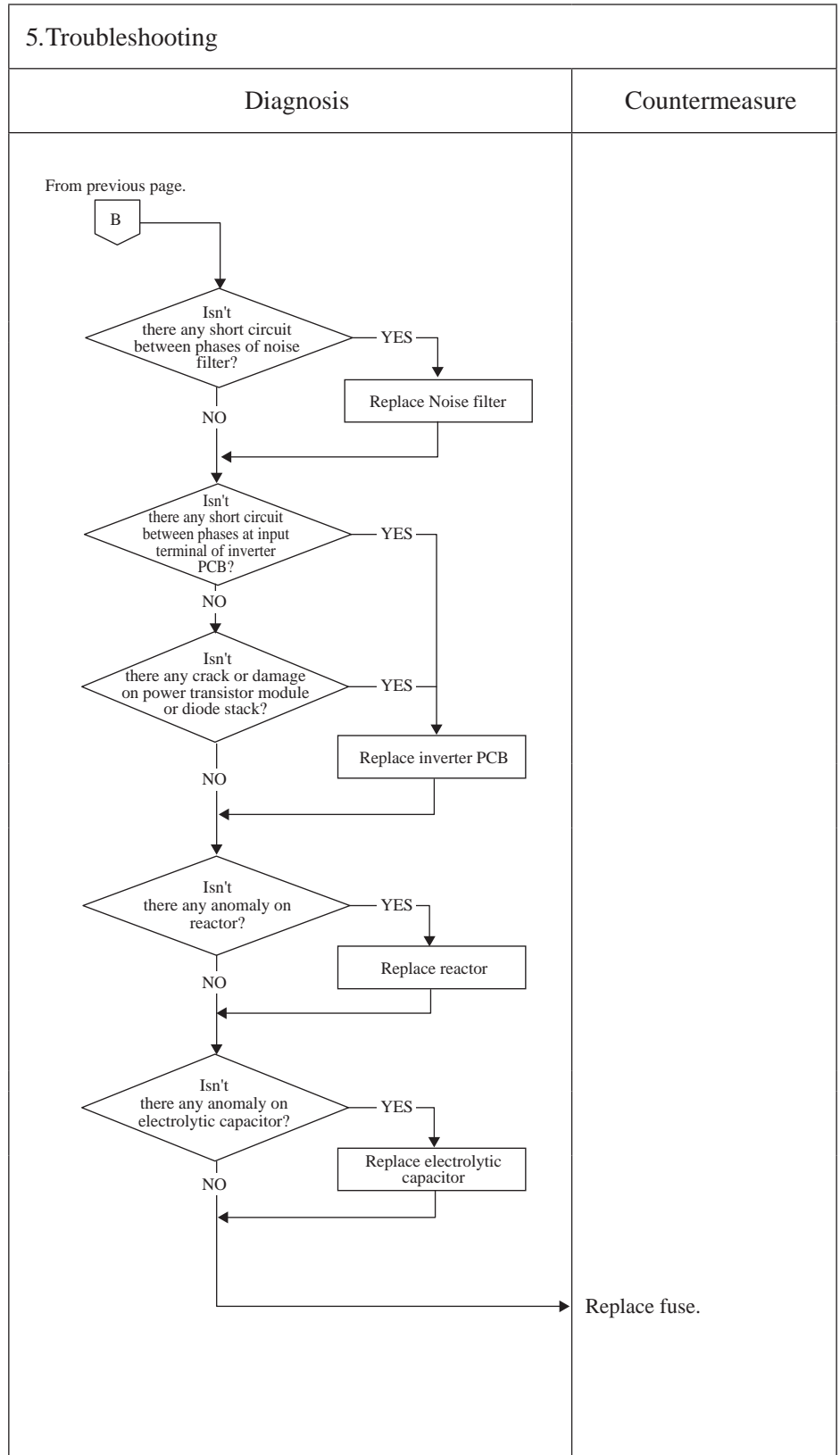

Note:

Error code Remote control: [No display] 7-segment display: -	LED	Green	Red	Content [No display]
	Indoor	Stays OFF	Stays OFF	
	Outdoor	Stays OFF	Stays OFF	

1. Applicable model

All models
(No display on the remote control after power ON.)

2. Error detection method

3. Condition of error displayed

4. Presumable cause

- Fuse blown
- Noise filter anomaly
- Anomalous connection of wire between PCBs
- Indoor unit control PCB anomaly
- Remote control anomaly
- Breakage of connecting wires of remote control
- Outdoor unit control PCB anomaly

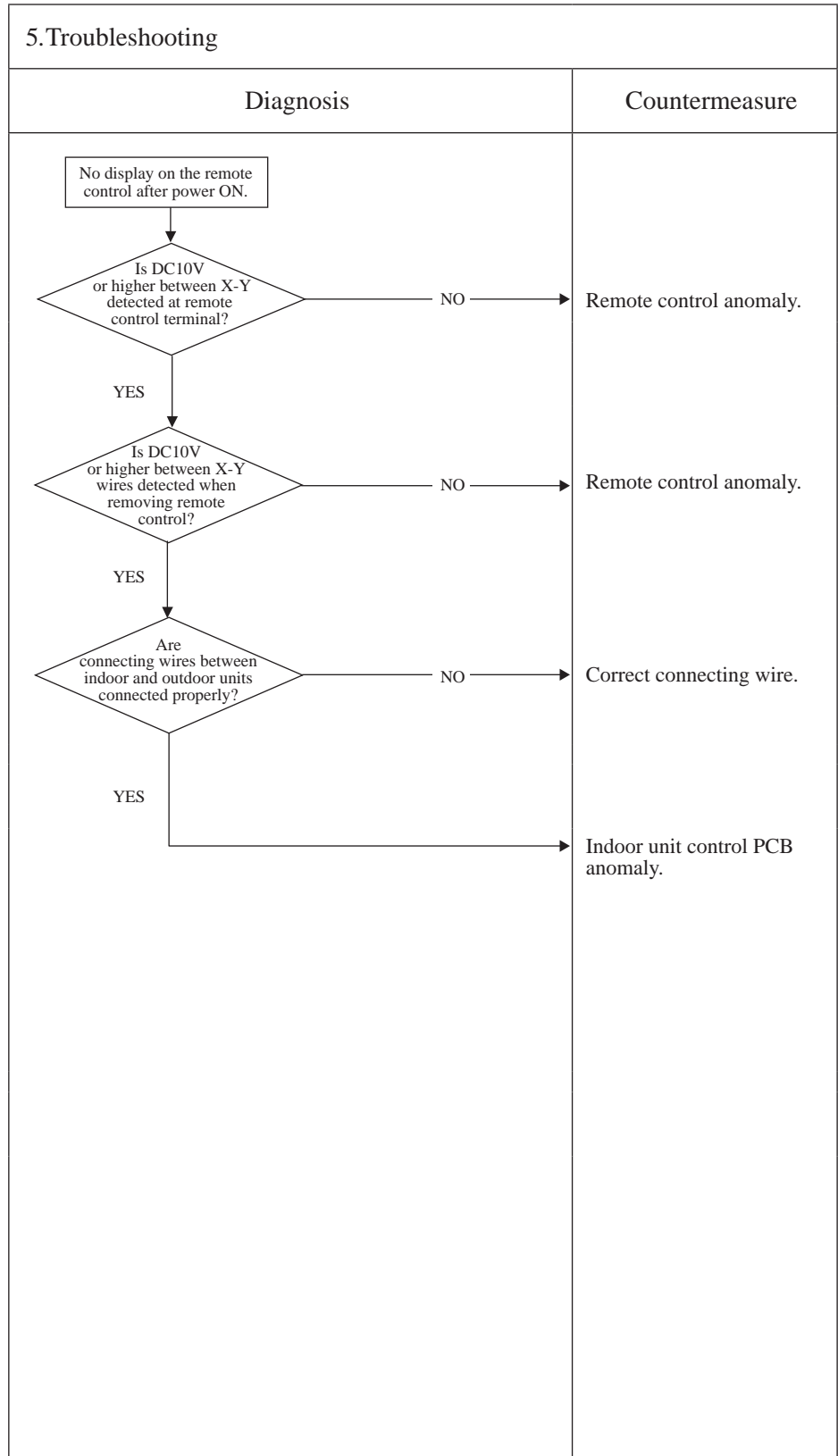

Note:

Error code Remote control: E1 7-segment display: -	LED	Green	Red	Content <h2 style="text-align: center;">Remote control communication error</h2>
	Indoor	Keeps flashing	Stays OFF	
	Outdoor	Keeps flashing	Stays OFF	

1. Applicable model All models
2. Error detection method When normal communication between remote control and indoor unit is interrupted for more than 2 minutes. (Detectable only with the remote control.)
3. Condition of error displayed Same as above
4. Presumable cause <ul style="list-style-type: none"> • Anomalous communication circuit between remote control and indoor unit. • Noise

5. Troubleshooting	
Diagnosis	Countermeasure
<pre> graph TD Q1{Is it possible to reset normally by the power source reset?} Q1 -- YES --> C1[Malfunction by temporary noise. Check peripheral environment.] Q1 -- NO --> P1[Turn SW7-1 OFF. → ON Disconnect the wire (3) between indoor and outdoor units.] P1 --> P2[Reset power source] P2 --> Q2{Does the drain pump start automatically at one minutes after power ON?} Q2 -- YES --> C2[Indoor unit control PCB anomaly → Replace it.] Q2 -- NO --> C3[Remote control anomaly → Replace it.] </pre> <p>Note (1) SW7-1: OFF → ON</p> <p>Note (2) Does the remote control displays "Internal check ON" even after 3 minutes?</p>	

Note: If the indoor unit cannot communicate normally with the remote control for 180 seconds, the indoor unit PCB starts to reset automatically.

Error code Remote control: E2 7-segment display: –	LED	Green	Red	Content <h2 style="text-align: center;">Duplicated indoor unit address</h2>
	Indoor	Keeps flashing	1-time flash	
	Outdoor	Keeps flashing	Stays OFF	

1. Applicable model
All models

2. Error detection method
More than 129 indoor units are connected in the same Superlink system. Duplicated indoor unit address

3. Condition of error displayed
Same as above

4. Presumable cause
<ul style="list-style-type: none"> • Number of connected indoor units exceeds the limitation. • Duplicated indoor unit address • Indoor unit control PCB anomaly

5. Troubleshooting	
Diagnosis	Countermeasure
<pre> graph TD Q1{Is the number of connected indoor units up to 128 units?} Q2{Is the different address No. assigned to each indoor unit?} Q3{Is E2 displayed?} Q1 -- NO --> C1[Review number of connected units.] Q1 -- YES --> Q2 Q2 -- NO --> C2[Correct indoor unit address setting.] Q2 -- YES --> P1[Reset the power source and restart.] P1 --> C3[Caution: Unless the power source is reset, addresses will not be confirmed.] C3 --> Q3 Q3 -- NO --> C4[Implement test run.] Q3 -- YES --> C5[Replace indoor control PCB. *] C5 --> F1[* Before replacement, confirm whether the rotary switch for address setting is not damaged.] </pre>	

Note:

Error code Remote control: E3/5 7-segment display: –	LED	Green	Red	Content <h2 style="text-align: center;">Outdoor unit signal line error</h2>
	Indoor	Keeps flashing	2-time flash	
	Outdoor	Keeps flashing	Stays OFF	

1. Applicable model
All models

2. Error detection method
No outdoor unit exists in the same Superlink system.

3. Condition of error displayed
Same as above

4. Presumable cause
<ul style="list-style-type: none"> • Power is not supplied to the outdoor unit • Unmatch of pairing between indoor and outdoor units • Indoor unit control PCB anomaly • Outdoor unit control PCB anomaly • Missing local wiring

5. Troubleshooting	
Diagnosis	Countermeasure
<p>E3 is a communication error that occurs when communication between indoor and outdoor units is not established at all. Once the communication between indoor and outdoor units is established, it changes to E5. In both cases, check signal line wired locally.</p> <pre> graph TD Start[Reset the power source and restart.] --> D1{Does E3/E5 occurs?} D1 -- NO --> C1[Temporary malfunction by noise. Identify the source of noise and correct it.] D1 -- YES --> D2{Is protective fuse for the Superlink circuit blown?} D2 -- YES --> C2[Change to spare circuit.] D2 -- NO --> D3{Is the LED on indoor control PCB OK?} D3 -- NO --> C3[Indoor control PCB anomaly → Replace it.] D3 -- YES --> D4{Is the power source to outdoor unit OK?} D4 -- NO --> C4[Correct it.] D4 -- YES --> D5{Is the outdoor unit address set on the indoor unit OK?} D5 -- NO --> C5[Correct it.] D5 -- YES --> D6{Is the Superlink communication wire connection OK?} D6 -- NO --> C6[Correct it.] D6 -- YES --> C7[Outdoor unit control PCB anomaly → Replace it.] </pre>	

Note:

Error code Remote control: E5 7-segment display: –	LED	Green	Red	Content Communication error during operation
	Indoor	Keeps flashing	*See below	
	Outdoor	Keeps flashing	2-time flash	

1. Applicable model
All models
2. Error detection method
When the communication between indoor and outdoor units is interrupted for more than 2 minutes.
3. Condition of error displayed
When this anomaly is detected during operation.
4. Presumable cause
<ul style="list-style-type: none"> • Unit address No. setting error • Remote control wires broken • Poor connection/disconnection of remote control wires • Indoor unit control PCB anomaly

5. Troubleshooting	
Diagnosis	Countermeasure
<p>* In case that indoor red LED flashes 2 times</p> <p>Note (1) Check the connection (disconnection, looseness) of signal wires at outdoor terminal block.</p> <p>Is the connection of signal wires at the outdoor unit side OK?</p> <p>NO → Repair signal wires.</p> <p>YES</p> <p>Note (2) Check the connection (disconnection, looseness, breakage) of signal wires between indoor and outdoor units.</p> <p>Is the connection of signal wires between indoor and outdoor units OK?</p> <p>NO → Repair signal wires.</p> <p>YES</p> <p>Reset the power source and restart.</p> <p>Does the remote control LCD becomes normal?</p> <p>NO → Go to the diagnosis of WAIT (1)</p> <p>YES → Unit is normal. (Malfunction by temporary noise, etc.)</p> <p>* In case that indoor red LED stays OFF</p> <p>Reset the power source and restart.</p> <p>Does the remote control LCD becomes normal?</p> <p>NO → Outdoor unit control PCB anomaly (Network communication circuit anomaly) → Replace it.</p> <p>YES → Unit is normal. (Malfunction by temporary noise, etc.)</p>	

Note: When the pump down switch is turned on, communication between indoor and outdoor units is cancelled so that "Communication error E5" will be displayed on the remote control and indoor control PCB, but this is normal.

Error code Remote control: E6 7-segment display: -	LED	Green	Red	Content Indoor heat exchanger temperature thermistor anomaly (Thi-R)
	Indoor	Keeps flashing	1-time flash	
	Outdoor	Keeps flashing	Stays OFF	

1. Applicable model

All models

2. Error detection method

Detection of anomalously low temperature (resistance) of Thi-R1, R2, R3.

3. Condition of error displayed

- If -40°C or lower is detected for 5 seconds continuously, compressor stops. After 3-minutes delay, the compressor is restarted automatically, but if this anomaly occurs again within 60 minutes after the initial detection.
- Or if 70°C or higher is detected for 5 seconds continuously.

4. Presumable cause

- Anomalous connection of indoor heat exchanger temperature thermistor
- Indoor heat exchanger temperature thermistor anomaly
- Indoor unit control PCB anomaly

5. Troubleshooting

Diagnosis	Countermeasure																
<pre> graph TD Q1{Is the connector of thermistor connected properly?} -- NO --> C1[Insert the connector securely.] Q1 -- YES --> Q2{Are the characteristics of thermistor OK? *1} Q2 -- NO --> C2[Replace thermistor. (Thi-R)] Q2 -- YES --> C3[Replace indoor unit control PCB.] </pre> <p style="text-align: center;">*1 Check several times to prove any poor connection</p>																	
<p>Temperature-resistance characteristics of indoor heat exchanger temperature thermistor (Thi-R1, R2, R3)</p> <table border="1"> <caption>Approximate data points from the graph</caption> <thead> <tr> <th>Temperature (°C)</th> <th>Resistance (k)</th> </tr> </thead> <tbody> <tr><td>0</td><td>15</td></tr> <tr><td>10</td><td>10</td></tr> <tr><td>20</td><td>7</td></tr> <tr><td>25</td><td>5</td></tr> <tr><td>30</td><td>4</td></tr> <tr><td>40</td><td>3</td></tr> <tr><td>50</td><td>2.5</td></tr> </tbody> </table>	Temperature (°C)	Resistance (k)	0	15	10	10	20	7	25	5	30	4	40	3	50	2.5	
Temperature (°C)	Resistance (k)																
0	15																
10	10																
20	7																
25	5																
30	4																
40	3																
50	2.5																

Note:

Error code Remote control: E7 7-segment display: –	LED	Green	Red	Content Indoor return air temperature thermistor anomaly (Thi-A)
	Indoor	Keeps flashing	1-time flash	
	Outdoor	Keeps flashing	Stays OFF	

1. Applicable model

All models

2. Error detection method

Detection of anomalously low temperature (resistance) of Thi-A.

3. Condition of error displayed

- If -20°C or lower is detected for 5 seconds continuously, compressor stops. After 3-minutes delay the compressor is restarted automatically, but if this anomaly occurs again within 60 minutes after the initial detection.
- Or if 48°C or higher is detected for 5 seconds continuously.

4. Presumable cause

- Anomalous connection of indoor return air temperature thermistor
- Indoor return air temperature thermistor anomaly
- Indoor unit control PCB anomaly

5. Troubleshooting

Diagnosis	Countermeasure																
<pre> graph TD Q1{Is the connector of thermistor connected properly?} -- NO --> C1[Insert the connector securely.] Q1 -- YES --> Q2{Are the characteristics of thermistor OK? *1} Q2 -- NO --> C2[Replace thermistor (Thi-A).] Q2 -- YES --> C3[Replace indoor unit control PCB.] </pre> <p>*1 Check several times to prove any poor connection</p> <p>Temperature-resistance characteristics of indoor return air temperature thermistor (Thi-A)</p> <table border="1"> <caption>Approximate data points from the graph</caption> <thead> <tr> <th>Temperature (°C)</th> <th>Resistance (k)</th> </tr> </thead> <tbody> <tr><td>0</td><td>15</td></tr> <tr><td>10</td><td>10</td></tr> <tr><td>20</td><td>6</td></tr> <tr><td>25</td><td>5</td></tr> <tr><td>30</td><td>4</td></tr> <tr><td>40</td><td>3</td></tr> <tr><td>50</td><td>2</td></tr> </tbody> </table>	Temperature (°C)	Resistance (k)	0	15	10	10	20	6	25	5	30	4	40	3	50	2	<p>Regarding the characteristics of the thermistor, see the following chart.</p>
Temperature (°C)	Resistance (k)																
0	15																
10	10																
20	6																
25	5																
30	4																
40	3																
50	2																

Note:

Error code Remote control: E9 7-segment display: –	LED	Green	Red	Content <h2 style="text-align: center;">Drain trouble</h2>
	Indoor	Keeps flashing	1-time flash	
	Outdoor	Keeps flashing	Stays OFF	

1. Applicable model

FDT, FDTC, FDTW, FDTQ, FDTS, FDR, FDU, FDUM, and FDUT series

2. Error detection method

Float switch is activated.

3. Condition of error displayed

If the float switch OPEN is detected for 3 seconds continuously or if float switch connector is disconnected or wire broken.

- 4. Presumable cause**
- Indoor unit control PCB anomaly
 - Mistake in setting of float switch
 - Mistake in setting of humidifier drain motor interlock
 - Mistake in setting of optional equipment
 - Mistake in drain piping
 - Drain motor anomaly
 - Disconnection/breakage of drain motor wires

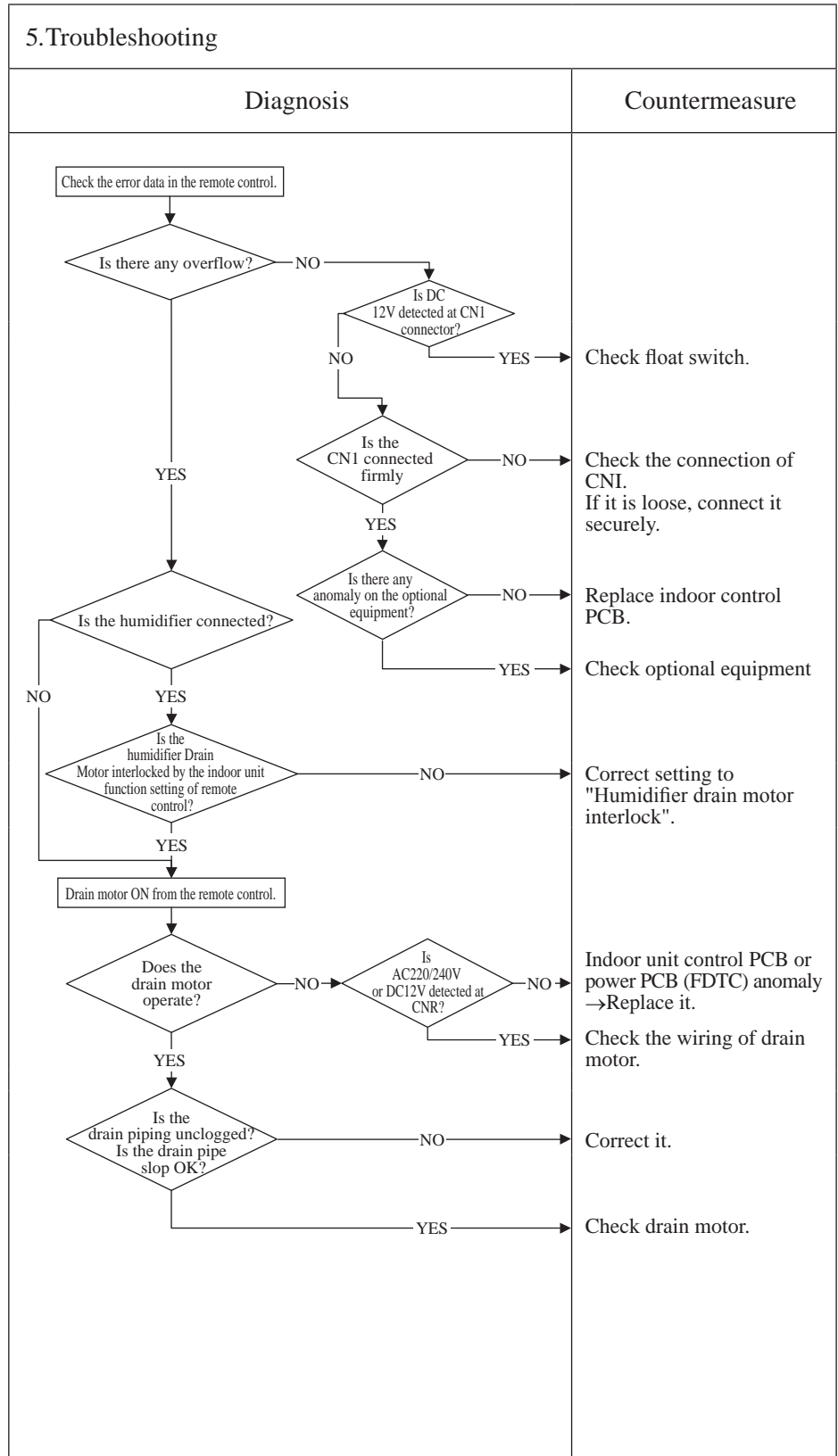

Note: When this anomaly occurs at power ON, disconnection of connector or breakage of wire of float switch is suspected. Check and correct it (or replace it, if necessary).

Error code Remote control: E10 7-segment display: –	LED	Green	Red	Content Excessive number of indoor units (more than 17 units) by controlling one remote control
	Indoor	Keeps flashing	Stays OFF	
	Outdoor	Keeps flashing	Stays OFF	

1. Applicable model

All models

2. Error detection method

When it detects more than 17 of indoor units connected to one remote control.

3. Condition of error displayed

Same as above

4. Presumable cause

- Excessive number of indoor units connected.
- Remote control anomaly.

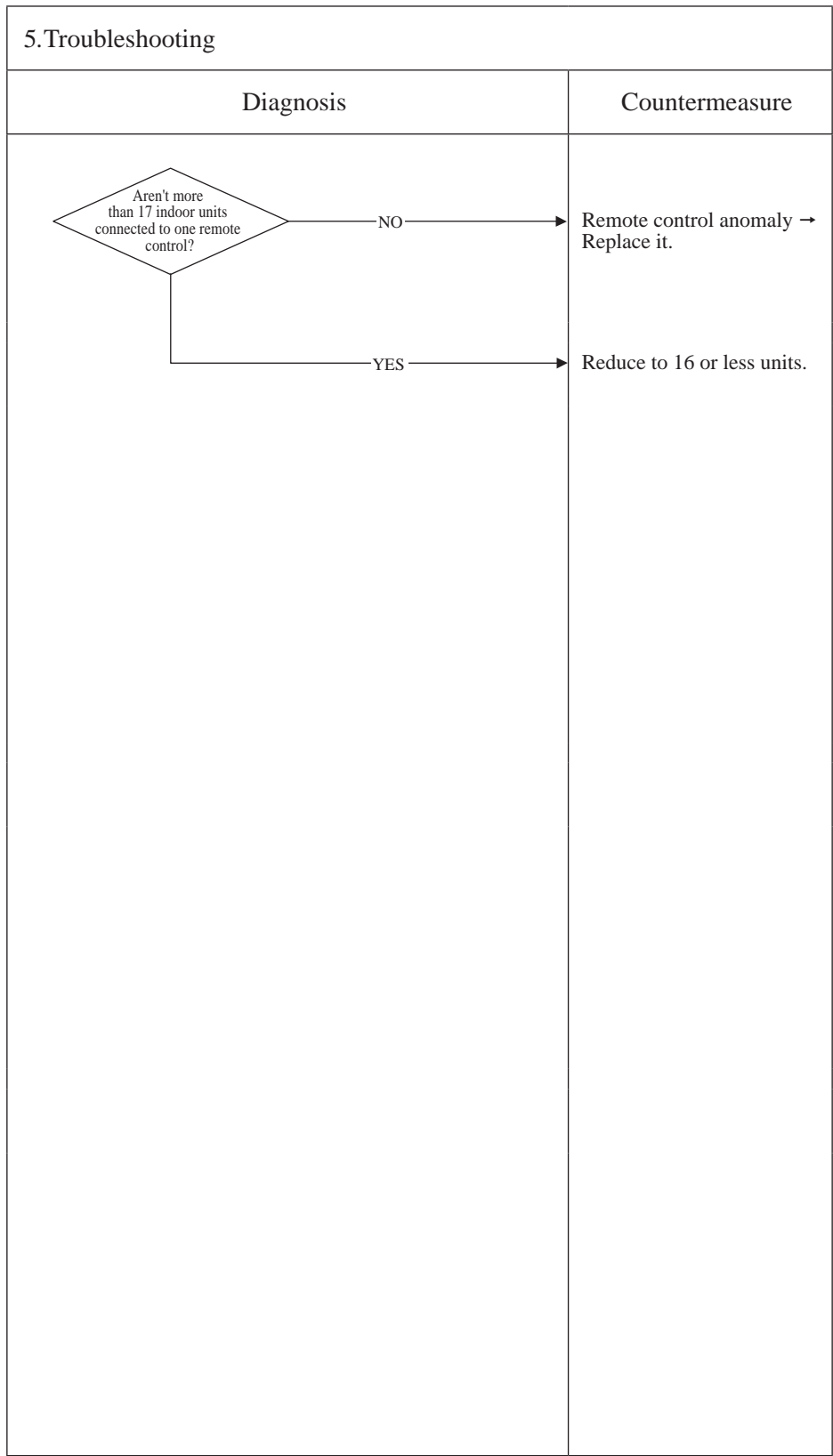

Note:

Error code Remote control: E11 7-segment display: –	LED	Green	Red	Content Address setting error between master and slave indoor units
	Indoor	Keeps flashing	Stays OFF	
	Outdoor	Keeps flashing	Stays OFF	

1. Applicable model

All models

2. Error detection method

IU address has been set using the “Master IU address set” function of remote control.

3. Condition of Error displayed

Same as above

4. Presumable cause

Same as above
 When a remote control is connected to two or more indoor units, it cannot set the remote control address.

5. Troubleshooting

Diagnosis	Countermeasure
<pre> graph TD E11[E11 occurs] --> Q{Is "Master IU address set" function of remote control used?} Q -- YES --> CM[Remote control anomaly -> Replace it. Set the address using the dip switch SW2 and SW5-1 or -2 (Master-Slave setting) on the indoor unit control PCB.] </pre> <p>In case the wiring is below and “Master IU address set” is used, E11 is appeared.</p>	<p>Remote control anomaly → Replace it. Set the address using the dip switch SW2 and SW5-1 or -2 (Master-Slave setting) on the indoor unit control PCB.</p>

Note:

Error code Remote control: E12 7-segment display: -	LED	Green	Red	Content <h2 style="text-align: center;">Address setting error by mixed setting method</h2>
	Indoor	Keeps flashing	1-time flash	
	Outdoor	Keeps flashing	Stays OFF	

1.Applicable model

All models

2.Error detection method

Automatic address setting and manual address setting are mixed when setting address of indoor units.

3. Condition of error displayed

Same as above

4.Presumable cause

Mistake in address setting for indoor unit.

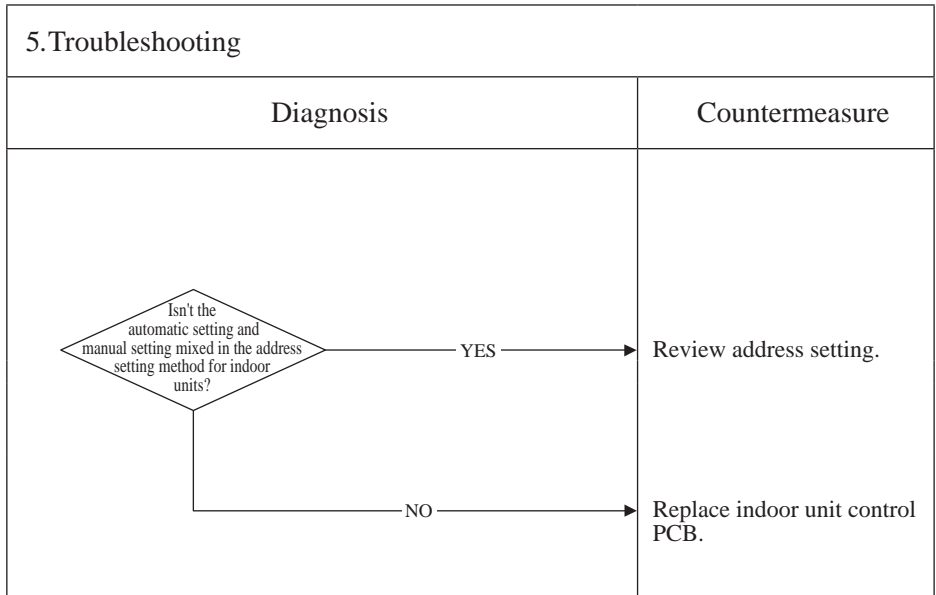

Address setting method list (Figures in [] are for Previous Superlink models)

		Models for new Superlink protocol			Models for Previous Superlink protocol		
		Indoor unit address setting		Outdoor unit address setting	Indoor unit address setting		Outdoor unit address setting
		Indoor unit No. SW	Outdoor unit No. SW	Outdoor unit No. SW	Indoor unit No. SW	Outdoor unit No. SW	Outdoor unit No. SW
Manual address setting	(New SL)	000-127	00-31	00-31	00-47	00-47	00-47
	(Previous SL)	[00-47]	[00-47]	[00-47]			
Automatic address setting for single refrigerant system	(New SL)	000	49	49	49	49	49
	(Previous SL)						
Automatic address setting for multiple refrigerant systems	(New SL)	000	49	00-31	Not available		
	(Previous SL)	Not available					

Note:

Error code Remote control: E16 7-segment display: –	LED	Green	Red	Content Indoor DC fan motor anomaly
	Indoor	Keeps flashing	1-time flash	
	Outdoor	Keeps flashing	Stays OFF	

1. Applicable model
FDT, FDTC, FDTW, FDTS, FDU, FDUM, FDUT71, FDK, FDE, FDFW, FDU-F series
2. Error detection method
Detected by rotation speed of indoor fan motor
3. Condition of error displayed
<ul style="list-style-type: none"> When actual rotation speed of indoor fan motor drops to lower than 200min⁻¹ for 30 seconds continuously, the compressor and the indoor fan motor stop. After 2 seconds, it starts again automatically, but if this error occurs 4 times within 60 minutes after the initial detection.
4. Presumable cause
<ul style="list-style-type: none"> Defective indoor unit power (control) PCB Foreign material at rotational area of fan propeller Defective fan motor Dust on control PCB Blown fuse External noise, surge

5. Troubleshooting	
Diagnosis	Countermeasure

Note:

Error code Remote control: E18 7-segment display: –	LED	Green	Red	Content <h2 style="text-align: center;">Address setting error of master and slave indoor units</h2>
	Indoor	Keeps flashing	1-time flash	
	Outdoor	Keeps flashing	Stays OFF	

1. Applicable model
All models

2. Error detection method
(1) When the address setting for the master indoor unit is not existing in the same Superlink system. (2) When the address setting for the slave indoor unit is set for the master indoor unit redundantly.

3. Condition of Error displayed
Same as above

4. Presumable cause
<ul style="list-style-type: none"> ▪ Address setting error of the master indoor unit ▪ No power source to the master indoor unit ▪ No connection of Superlink signal wires between master and slave indoor unit.

5. Troubleshooting	
Diagnosis	Countermeasure
<pre> graph TD Q1{Is the address setting for the master indoor unit correct?} -- NO --> C1[Correct the address setting of the master indoor unit] Q1 -- YES --> Q2{Is the power source supplied to the master indoor unit?} Q2 -- NO --> C2[Power source to the master indoor unit] Q2 -- YES --> Q3{Are the Superlink signal wires connected between master and slave indoor units?} Q3 -- NO --> C3[Connect the Superlink signal wires correctly.] Q3 -- YES --> C4[Indoor unit control PCB anomaly Replace it (Firstly replace PCB on the slave indoor unit. If it is not recovered, replace PCB on the master indoor unit as well.)] </pre>	

Note:

Error code Remote control: E19 7-segment display: –	LED	Green	Red	Content Indoor unit operation check, drain motor check mode anomaly
	Indoor	Keeps flashing	1-time flash	
	Outdoor	Keeps flashing	Stays OFF	

1. Applicable model
All models

2. Error detection method
E19 occurs

3. Condition of error displayed
Same as above

4. Presumable cause
Mistake in SW7-1 setting Due to forgetting to turn OFF SW7-1 after indoor operation check.

5. Troubleshooting	
Diagnosis	Countermeasure
<pre> graph TD Start[E19 occurs when the power ON] --> Decision{Is SW7-1 on the indoor control PCB ON?} Decision -- YES --> Countermeasure1[Turn SW7-1 on the indoor control PCB OFF and reset the power.] Decision -- NO --> Countermeasure2[Indoor control PCB anomaly (Anomalous SW7) -> Replace.] </pre>	

Note: Indoor operation check/drain pump check mode
 If the power is ON after SW7-1ON, indoor operation check/drain pump check mode can be established.
 1) When the communication between remote control and indoor PCB is established 15 seconds after power ON, it goes to indoor operation check.
 2) When the communication between remote control and indoor PCB is not established, it goes to drain pump check. (CnB connector should be open before power ON.)

Error code Remote control: E20 7-segment display: -	LED	Green	Red	Content Indoor DC fan motor rotation speed anomaly
	Indoor	Keeps flashing	1-time flash	
	Outdoor	Keeps flashing	Stays OFF	

1.Applicable model FDT, FDTC, FDTW, FDTS, FDU, FDUM, FDUT71, FDK, FDE, FDFW, FDU-F series
2.Error detection method Detected by rotation speed of indoor fan motor
3.Condition of error displayed When the actual fan rotation speed does not reach to the speed of [required speed -50 (FDU : -500) min ⁻¹] after 2 minutes have been elapsed since the fan motor rotation speed command was output, the unit stops by detecting indoor fan motor anomaly.
4.Presumable cause <ul style="list-style-type: none"> • Defective indoor unit power (control) PCB • Foreign material at rotational area of fan propeller • Defective fan motor • Dust on control PCB • Blown fuse • External noise, surge

5.Troubleshooting	
Diagnosis	Countermeasure
<pre> graph TD Q1{Does any foreign material intervene in rotational area of fan propeller?} -- YES --> C1[Remove foreign material.] Q1 -- NO --> Q2{Does the fan rotate smoothly when turned by hand?} Q2 -- NO --> C2[Replace the fan motor.] Q2 -- YES --> Q3{Is DC280V detected between Model A : ①-②, Model B : ①-② of fan motor connector CNM?} Note1[Note (1) Model A : Except model B Model B : FDK, FDFW] --- Q3 Q3 -- NO --> Q4{Is the fuse F3 (F4) or F202 blown?} Q4 -- NO --> C3[Check power voltage.] Q4 -- YES --> C4[Replace faulty fan motor and power PCB.] Q3 -- YES --> Q5{Is DC15V detected between connector CNM Model A : ③-④, Model B : ③-④ when the fan motor on command is released?} Q5 -- NO --> Q6{Is DC15V detected between CNM Model A : ④-⑤, Model B : ④-⑤ when the connector is disconnected at the fan motor side and the fan motor on command is released?} Q6 -- NO --> C5[Replace the indoor unit control PCB.] Q6 -- YES --> C6[Replace fan motor.] Q5 -- YES --> R1[Power source reset] R1 --> Q7{Is it normalized?} Q7 -- NO --> C7[Replace fan motor. (If the error persists after replacing the fan motor, replace the indoor unit control PCB.)] Q7 -- YES --> C8[Malfunction by temporary noise] </pre>	

Note:

Error code Remote control: E21 7-segment display: –	LED	Green	Red	Content <h2 style="text-align: center;">Defective panel switch operation (FDT)</h2>
	Indoor	Keeps flashing	1-time flash	
	Outdoor	Keeps flashing	Stays OFF	

1.Applicable model
FDT series only

2.Error detection method
Panel switch (PS) has detected Open for more than 1 second.

3.Condition of Error displayed
Same as above

4.Presumable cause

- Defective panel switch
- Disconnection of wiring
- Defective indoor control PCB

5.Troubleshooting

Diagnosis	Countermeasure
<pre> graph TD Q1{Is grill opened?} -- YES --> C1[Reset the error and close the grill.] Q1 -- NO --> Q2{Does matter improve if panel switch is turned ON forcibly after resetting error?} Q2 -- YES --> C2[Insufficient push on the panel switch at the internal face of grill] Q2 -- NO --> Q3{Are connectors at right inserted properly?} Q3 -- NO --> C3[Disconnected, poorly connected connectors] Q3 -- YES --> Q4{Is there continuity between #1 - #4 of CNV on indoor control PCB when panel switch operation is checked?} Q4 -- NO --> C4[Defective panel switch or incorrect panel switch wiring] Q4 -- YES --> C5[Defective indoor control PCB] </pre>	<p>Reset the error and close the grill.</p> <p>Insufficient push on the panel switch at the internal face of grill → Attach 3 mm thick rubber sheet at the section where the panel switch touches the inside of grill. Close then the grill.</p> <p>Disconnected, poorly connected connectors → Reinsert properly.</p> <p>• Defective panel switch or incorrect panel switch wiring → Replace panel switch.</p> <p>• Broken wire between panel PCB (CNV) → Correct or replace wire.</p> <p>Defective indoor control PCB → Replace indoor control PCB.</p>

Note:

Error code Remote control: E28 7-segment display: –	LED	Green	Red	Content <h2 style="text-align: center;">Remote control temperature thermistor anomaly (Thc)</h2>
	Indoor	Keeps flashing	Stays OFF	
	Outdoor	Keeps flashing	Stays OFF	

1. Applicable model

All models

2. Error detection method

Detection of anomalously low temperature (resistance) of Thc.

3. Condition of error displayed

- If -50°C or lower is detected for 5 seconds continuously, compressor stops. After 3 minutes delay, the compressor is restarted automatically, but if this anomaly occurs again within 60 minutes after the initial detection.

4. Presumable cause

- Anomalous connection of remote control temperature thermistor
- Remote control temperature thermistor anomaly
- Remote control PCB anomaly

5. Troubleshooting

Diagnosis	Countermeasure																																																																								
<pre> graph TD Q1{Is the connector of thermistor connected properly?} -- NO --> C1[Insert the connector securely.] Q1 -- YES --> Q2{Are the characteristics of thermistor OK? Is the thermistor wire OK *1?} Q2 -- NO --> C2[Replace thermistor (Thc).] Q2 -- YES --> C3[Replace indoor unit control PCB.] </pre>																																																																									
<p>*1 Check several times to prove any poor connection.</p> <p>Temperature-resistance characteristics of remote control temperature thermistor (Thc).</p> <table border="1" style="margin: auto;"> <thead> <tr> <th>Temperature (°C)</th> <th>Resistance (kΩ)</th> <th>Temperature (°C)</th> <th>Resistance (kΩ)</th> <th>Temperature (°C)</th> <th>Resistance (kΩ)</th> <th>Temperature (°C)</th> <th>Resistance (kΩ)</th> </tr> </thead> <tbody> <tr><td>0</td><td>65</td><td>14</td><td>33</td><td>30</td><td>16</td><td>46</td><td>8.5</td></tr> <tr><td>1</td><td>62</td><td>16</td><td>30</td><td>32</td><td>15</td><td>48</td><td>7.8</td></tr> <tr><td>2</td><td>59</td><td>18</td><td>27</td><td>34</td><td>14</td><td>50</td><td>7.3</td></tr> <tr><td>4</td><td>53</td><td>20</td><td>25</td><td>36</td><td>13</td><td>52</td><td>6.7</td></tr> <tr><td>6</td><td>48</td><td>22</td><td>23</td><td>38</td><td>12</td><td>54</td><td>6.3</td></tr> <tr><td>8</td><td>44</td><td>24</td><td>21</td><td>40</td><td>11</td><td>56</td><td>5.8</td></tr> <tr><td>10</td><td>40</td><td>26</td><td>19</td><td>42</td><td>9.9</td><td>58</td><td>5.4</td></tr> <tr><td>12</td><td>36</td><td>28</td><td>18</td><td>44</td><td>9.2</td><td>60</td><td>5.0</td></tr> </tbody> </table>		Temperature (°C)	Resistance (kΩ)	Temperature (°C)	Resistance (kΩ)	Temperature (°C)	Resistance (kΩ)	Temperature (°C)	Resistance (kΩ)	0	65	14	33	30	16	46	8.5	1	62	16	30	32	15	48	7.8	2	59	18	27	34	14	50	7.3	4	53	20	25	36	13	52	6.7	6	48	22	23	38	12	54	6.3	8	44	24	21	40	11	56	5.8	10	40	26	19	42	9.9	58	5.4	12	36	28	18	44	9.2	60	5.0
Temperature (°C)	Resistance (kΩ)	Temperature (°C)	Resistance (kΩ)	Temperature (°C)	Resistance (kΩ)	Temperature (°C)	Resistance (kΩ)																																																																		
0	65	14	33	30	16	46	8.5																																																																		
1	62	16	30	32	15	48	7.8																																																																		
2	59	18	27	34	14	50	7.3																																																																		
4	53	20	25	36	13	52	6.7																																																																		
6	48	22	23	38	12	54	6.3																																																																		
8	44	24	21	40	11	56	5.8																																																																		
10	40	26	19	42	9.9	58	5.4																																																																		
12	36	28	18	44	9.2	60	5.0																																																																		

Note: After 10 seconds has elapsed since remote control temperature thermistor was switched from invalid to valid, E28 will not be displayed even if the thermistor harness is disconnected or broken. However, in such case, the indoor return air temperature thermistor (Thi-A) will be valid instantly instead of the remote control temperature thermistor (Thc). Please note that even though the remote control temperature thermistor (Thc) is valid, the displayed return air temperature on the remote control LCD shows the value detected by the indoor return air temperature thermistor (Thi-A), not by the remote control temperature thermistor (Thc).

Error code Remote control: E31 7-segment display: E31	LED	Green	Red	Content Duplicated outdoor unit address No.
	Indoor	Keeps flashing	Stays OFF	
	Outdoor	Keeps flashing	1-time flash	

1. Applicable model Outdoor unit
2. Error detection method When the microcomputer of outdoor control PCB recognizes the duplicated address No. by scanning all addresses of outdoor units in the same Superlink system.
3. Condition of error displayed When duplicated outdoor unit address No. exists in the same Superlink system.
4. Presumable cause <ul style="list-style-type: none"> Mistake in the address setting of outdoor units More than 129 indoor units connected [Maximum number can be set by address switch is 128 units] No setting of Master/Slave setting switch for combination use

5. Troubleshooting	
Diagnosis	Countermeasure
<pre> graph TD A[Save data for 30 minutes before stopping in Mente PC.] --> B[Reset the power source and restart operation.] B --> C{Does E31 recur?} C -- NO --> D[Test run *No action is taken because it is judged that the power reset is not done after changing address.] C -- YES --> E[Check outdoor address Nos. in the same Superlink system.] E --> F{Does the same address No. exist?} F -- YES --> G[Correct address.] F -- NO --> H[Replace outdoor unit control PCB. * * Before replacement, please confirm whether the rotary switch for address setting is not damaged.] </pre>	

Note: After taken above measure, reset the power and confirm no error is displayed occurs.
 Unless the power is reset after changing address, the set address will not be confirmed.
 In case of combination use, set the same address to both master and slave units. Distinction of master or slave unit is done by setting SW4-7 and 4-8. (Refer the instruction manual and technical manual for details)

Error code Remote control: E32 7-segment display: E32	LED	Green	Red	Content <h2 style="text-align: center;">Open L3 Phase on power source at primary side</h2>
	Indoor	Keeps flashing	Stays OFF	
	Outdoor	Keeps flashing	1-time flash	

1. Applicable model
Outdoor unit
2. Error detection method
By Checking the power source voltage at primary side of the outdoor unit control PCB. (Check only L3 phase)
3. Condition of error displayed
When the power source voltage between L1-N or L2-N becomes 0V and/or the current of L3 decrease to 0A.
4. Presumable cause
<ul style="list-style-type: none"> • Anomalous power source at primary side • Outdoor unit control PCB anomaly.

5. Troubleshooting	
Diagnosis	Countermeasure
<pre> graph TD A[Save data for 30 minutes before stopping in Mente PC.] --> B{Is the power source voltage (between phases) at the primary side OK?} B -- NO --> C[Propose an improvement to the customer.] B -- YES --> D[Reset the power source and restart operation.] D --> E{Does E32 recur?} E -- YES --> F[Replace outdoor unit control PCB.] E -- NO --> G[Restart operation] G --> H{Does E32 recur?} H -- YES --> I[Check the connection of wire.] H -- NO --> J[Wait and see without taking any action.] </pre>	<p>Check and save the data of operating condition. Check the conditions whether it occurs immediately after the power on or during operation or stopping. (It will be useful to persuade the customer why an improvement of power source is required by showing these data.)</p> <p>Propose an improvement to the customer.</p> <p>Check it, as much as possible, under the operating conditions for 30 minutes before error occurred.</p> <p>Replace outdoor unit control PCB.</p> <p>Check the connection of wire.</p> <p>Wait and see without taking any action.</p>

Note:

Error code Remote control: E36 7-segment display: E36-1, 2 *1	LED	Green	Red	Content Discharge pipe temperature error (Tho-D1, D2)
	Indoor	Keeps flashing	Stays OFF	
	Outdoor	Keeps flashing	*2	

*1 E36-1: Tho-D1, E36-2: Tho-D2 *2 E36-1: 1-time flash, E36-2: 2-time flash

<p>1. Applicable model</p> <p>Outdoor unit</p>	<p>5. Troubleshooting</p> <table border="1" style="width: 100%;"> <thead> <tr> <th style="width: 50%;">Diagnosis</th> <th style="width: 50%;">Countermeasure</th> </tr> </thead> <tbody> <tr> <td colspan="2" style="text-align: center;"> <div style="border: 1px solid black; padding: 2px; display: inline-block;">Save data for 30 minutes before stopping in Mente PC.</div> </td> </tr> <tr> <td style="text-align: center;"> Is the unit installation environment within the range of limitation? NO → </td> <td> Check and save the data of operating condition Check the ROM version Confirmation of SV1, 2 operation Propose an improvement to the customer. </td> </tr> <tr> <td style="text-align: center;"> YES → Are the refrigerant amount and piping length OK? NO → </td> <td> Adjust the refrigerant amount properly. (Check whether the refrigerant amount is insufficient or not.) (Check the gas leakage) </td> </tr> <tr> <td style="text-align: center;"> YES → Is the insertion of the thermistor connector into the connector on outdoor unit control PCB OK? NO → </td> <td> Insert connector securely. </td> </tr> <tr> <td style="text-align: center;"> YES → Is the discharge pipe temperature thermistor OK? NO → </td> <td> Check if the characteristics are correct by referring the characteristics chart of E39. And if necessary, replace the discharge pipe temperature thermistor. </td> </tr> <tr> <td style="text-align: center;"> YES → <div style="border: 1px solid black; padding: 2px; display: inline-block;">Reset the power source and restart operation.</div> </td> <td> Check it, as much as possible, under the operating conditions for 30 minutes before error occurred. </td> </tr> <tr> <td style="text-align: center;"> Does the error recur when restarting? NO → </td> <td> Wait and see. Continue to obtain data, if possible. (Keep connecting the Mente PC) </td> </tr> <tr> <td style="text-align: center;"> YES → Is there AC220-240V of output signal for SV1, 2 from outdoor unit control PCB? NO → </td> <td> Replace outdoor unit control PCB. </td> </tr> <tr> <td style="text-align: center;"> YES → Is the coil of SV1, 2 energized? NO → </td> <td> Replace the coil SV1, 2. </td> </tr> <tr> <td style="text-align: center;"> YES → Does the refrigerant flow through SV1, 2 main body? NO → </td> <td> Replace the SV1, 2 main body. (If there is no refrigerant in liquid line, charge refrigerant additional) </td> </tr> <tr> <td style="text-align: center;"> YES → </td> <td> Check refrigerant amount again. </td> </tr> </tbody> </table>	Diagnosis	Countermeasure	<div style="border: 1px solid black; padding: 2px; display: inline-block;">Save data for 30 minutes before stopping in Mente PC.</div>		Is the unit installation environment within the range of limitation? NO →	Check and save the data of operating condition Check the ROM version Confirmation of SV1, 2 operation Propose an improvement to the customer.	YES → Are the refrigerant amount and piping length OK? NO →	Adjust the refrigerant amount properly. (Check whether the refrigerant amount is insufficient or not.) (Check the gas leakage)	YES → Is the insertion of the thermistor connector into the connector on outdoor unit control PCB OK? NO →	Insert connector securely.	YES → Is the discharge pipe temperature thermistor OK? NO →	Check if the characteristics are correct by referring the characteristics chart of E39. And if necessary, replace the discharge pipe temperature thermistor.	YES → <div style="border: 1px solid black; padding: 2px; display: inline-block;">Reset the power source and restart operation.</div>	Check it, as much as possible, under the operating conditions for 30 minutes before error occurred.	Does the error recur when restarting? NO →	Wait and see. Continue to obtain data, if possible. (Keep connecting the Mente PC)	YES → Is there AC220-240V of output signal for SV1, 2 from outdoor unit control PCB? NO →	Replace outdoor unit control PCB.	YES → Is the coil of SV1, 2 energized? NO →	Replace the coil SV1, 2.	YES → Does the refrigerant flow through SV1, 2 main body? NO →	Replace the SV1, 2 main body. (If there is no refrigerant in liquid line, charge refrigerant additional)	YES →	Check refrigerant amount again.
Diagnosis	Countermeasure																								
<div style="border: 1px solid black; padding: 2px; display: inline-block;">Save data for 30 minutes before stopping in Mente PC.</div>																									
Is the unit installation environment within the range of limitation? NO →	Check and save the data of operating condition Check the ROM version Confirmation of SV1, 2 operation Propose an improvement to the customer.																								
YES → Are the refrigerant amount and piping length OK? NO →	Adjust the refrigerant amount properly. (Check whether the refrigerant amount is insufficient or not.) (Check the gas leakage)																								
YES → Is the insertion of the thermistor connector into the connector on outdoor unit control PCB OK? NO →	Insert connector securely.																								
YES → Is the discharge pipe temperature thermistor OK? NO →	Check if the characteristics are correct by referring the characteristics chart of E39. And if necessary, replace the discharge pipe temperature thermistor.																								
YES → <div style="border: 1px solid black; padding: 2px; display: inline-block;">Reset the power source and restart operation.</div>	Check it, as much as possible, under the operating conditions for 30 minutes before error occurred.																								
Does the error recur when restarting? NO →	Wait and see. Continue to obtain data, if possible. (Keep connecting the Mente PC)																								
YES → Is there AC220-240V of output signal for SV1, 2 from outdoor unit control PCB? NO →	Replace outdoor unit control PCB.																								
YES → Is the coil of SV1, 2 energized? NO →	Replace the coil SV1, 2.																								
YES → Does the refrigerant flow through SV1, 2 main body? NO →	Replace the SV1, 2 main body. (If there is no refrigerant in liquid line, charge refrigerant additional)																								
YES →	Check refrigerant amount again.																								
<p>2. Error detection method</p> <p>When anomalously high temperature is detected by the discharge pipe temperature thermistor (Tho-D1, D2).</p>																									
<p>3. Condition of error displayed</p> <p>When 130°C or higher is detected by the discharge temperature thermistor, the compressor stops. After 3 minutes delay, the compressor starts again. automatically, but if this anomaly occurs 2 times within 60 minutes after the initial detection, or 130°C or higher is detected continuously for 60 minutes.</p>																									
<p>4. Presumable cause</p> <ul style="list-style-type: none"> • Discharge pipe temperature anomaly • SV1, 2 (liquid refrigerant by-pass valve) anomaly <ul style="list-style-type: none"> • Breakage of coil • Faulty main body. • Outdoor unit control PCB anomaly • Insufficient amount of refrigerant • Insufficient airflow volume • Short-circuit of airflow 																									

Note:

Error code Remote control: E37 7-segment display: E37-1, 2, 3, 4, 5, 6*1 E37-8, 9	LED	Green	Red	Content Outdoor heat exchanger temperature thermistor (Tho-R) and subcooling coil temperature thermistor (Tho-SC,-H) anomaly
	Indoor	Keeps flashing	Stays OFF	
	Outdoor	Keeps flashing	*1	

*1 E37-1: 1-time flash (Tho-R1), E37-2: 2-time flash (Tho-R2), E37-3: 3-time flash (Tho-R3), E37-4: 4-time flash (Tho-R4), E37-5: 5-time flash (Tho-SC), E37-6: 6-time flash (Tho-H) E37-8: 8-time flash (Tho-R5), E37-9: 9-time flash (Tho-R6)

1.Applicable model
Outdoor unit

2.Error detection method
Detection of anomalously low temperature (resistance) of Tho-R or Tho-SC or Tho-H.

3. Condition of error displayed
<ul style="list-style-type: none"> If -50°C or lower is detected for 5 seconds continuously within 2-minutes to 2-minutes 20-seconds after the compressor ON, the compressor stops. And after 3-minutes delay, the compressor starts again automatically, but if this anomalous temperature is detected 3 times within 40 minutes after the initial detection. If -50°C or lower is detected for 5 seconds continuously within 20 seconds after power ON.

4.Presumable cause
<ul style="list-style-type: none"> Broken thermistor harness or the internal wire of sensing section (Check the molded section as well) Disconnection of thermistor harness connection (connector). Outdoor unit control PCB anomaly.

5.Troubleshooting																	
Diagnosis	Countermeasure																
<div style="border: 1px solid black; padding: 5px; width: fit-content; margin: 0 auto;">Save data for 30 minutes before stopping in Mente PC.</div>																	
<pre> graph TD Q1{Is the connector of thermistor connected properly?} -- NO --> C1[Insert the connector securely.] Q1 -- YES --> Q2{Are the characteristics of thermistor OK? *2} Q2 -- NO --> C2[Replace thermistor (Tho-SC, Tho-H, Tho-R).] Q2 -- YES --> C3[Replace outdoor unit control PCB.] </pre>	<p>Check and save the data of operating conditions. Check the conditions whether it occurs immediately after the power on or during operation or stopping. Check the sensed value. Compare the temperature on Mente PC with actual measured value.</p>																
<p>*2 Check several times to prove any poor connection</p>																	
<p>Outdoor heat exchanger temperature thermistor (Tho-R1-R6) Subcooling coil thermistor (Tho-SC, Tho-H) Temperature-resistance characteristics</p> <table border="1"> <caption>Temperature thermistor resistance characteristics</caption> <thead> <tr> <th>Temperature (°C)</th> <th>Temperature thermistor resistance (k)</th> </tr> </thead> <tbody> <tr><td>0</td><td>15</td></tr> <tr><td>10</td><td>10</td></tr> <tr><td>20</td><td>7</td></tr> <tr><td>25</td><td>5</td></tr> <tr><td>30</td><td>4</td></tr> <tr><td>40</td><td>3</td></tr> <tr><td>50</td><td>2</td></tr> </tbody> </table>		Temperature (°C)	Temperature thermistor resistance (k)	0	15	10	10	20	7	25	5	30	4	40	3	50	2
Temperature (°C)	Temperature thermistor resistance (k)																
0	15																
10	10																
20	7																
25	5																
30	4																
40	3																
50	2																

Note:

Error code Remote control: E38 7-segment display: E38	LED	Green	Red	Content Outdoor air temperature thermistor anomaly (Tho-A)
	Indoor	Keeps flashing	Stays OFF	
	Outdoor	Keeps flashing	1-time flash	

1. Applicable model

Outdoor unit

2. Error detection method

Detection of anomalously low temperature (resistance) of Tho-A

3. Condition of error displayed

- If -30°C or lower is detected for 5 seconds continuously within 2-minutes to 2-minutes 20-seconds after the compressor ON, the compressor stops. And after 3-minutes delay, the compressor starts again automatically, but if this anomalous temperature is detected 3 times within 40 minutes after the initial detection.
- If -30°C or lower is detected for 5 seconds continuously within 20 seconds after power ON.

4. Presumable cause

- Broken thermistor harness or the internal wire of sensing section (Check the molded section as well)
- Disconnection of thermistor harness connection (connector).
- Outdoor unit control PCB anomaly.

5. Troubleshooting

Diagnosis	Countermeasure
<div style="border: 1px solid black; padding: 5px; margin-bottom: 10px;">Save data for 30 minutes before stopping in Mente PC.</div> <pre> graph TD Q1{Is the connector of thermistor connected properly?} -- NO --> C1[Insert the connector securely.] Q1 -- YES --> Q2{Are the characteristics of thermistor OK?*1} Q2 -- NO --> C2[Replace thermistor (Tho-A).] Q2 -- YES --> C3[Replace unit outdoor control PCB.] </pre> <p>*1 Check several times to prove any poor connection</p>	<p>Check and save the data of operating condition. Check the conditions whether it occurs immediately after the power on or during operation or stopping. Check the sensed value. Compare the temperature on Mente PC with actual measured value.</p>

Temperature-resistance characteristics of outdoor air temperature thermistor (Tho-A)

Temperature (°C)	Temperature thermistor resistance (k)
-20	100
-10	70
0	45
10	30
20	20
30	15
40	10
50	5

Note:

Error code Remote control: E39 7-segment display: E39-1, 2*1	LED	Green	Red	Content <h2 style="text-align: center;">Discharge pipe temperature thermistor anomaly (Tho-D1, D2)</h2>
	Indoor	Keeps flashing	Stays OFF	
	Outdoor	Keeps flashing	*2	

*1 E39-1: Tho-D1, E39-2: Tho-D2, *2 E39-1: 1-time flash, E39-2: 2-time flash

<h3>1. Applicable model</h3> <p>Outdoor unit</p>	<h3>5. Troubleshooting</h3> <table border="1" style="width: 100%;"> <thead> <tr> <th style="width: 50%;">Diagnosis</th> <th style="width: 50%;">Countermeasure</th> </tr> </thead> <tbody> <tr> <td style="text-align: center;"> <div style="border: 1px solid black; padding: 5px; margin-bottom: 10px;">Save data for 30 minutes before stopping in Mente PC.</div> <pre> graph TD Q1{Is the connector of thermistor connected properly?} -- NO --> C1[Insert the connector securely.] Q1 -- YES --> Q2{Are the characteristics of thermistor OK? *3} Q2 -- NO --> C2[Replace thermistor (Tho-D1 or D2).] Q2 -- YES --> C3[Replace outdoor unit control PCB.] </pre> </td> <td style="vertical-align: top;"> <p>Check and save the data of operating condition. Check the conditions whether it occurs immediately after the power on or during operation or stopping. Check the sensed value. Compare the temperature on Mente PC with actual measured value.</p> </td> </tr> </tbody> </table> <p>*3 Check several times to prove any poor connection</p>	Diagnosis	Countermeasure	<div style="border: 1px solid black; padding: 5px; margin-bottom: 10px;">Save data for 30 minutes before stopping in Mente PC.</div> <pre> graph TD Q1{Is the connector of thermistor connected properly?} -- NO --> C1[Insert the connector securely.] Q1 -- YES --> Q2{Are the characteristics of thermistor OK? *3} Q2 -- NO --> C2[Replace thermistor (Tho-D1 or D2).] Q2 -- YES --> C3[Replace outdoor unit control PCB.] </pre>	<p>Check and save the data of operating condition. Check the conditions whether it occurs immediately after the power on or during operation or stopping. Check the sensed value. Compare the temperature on Mente PC with actual measured value.</p>
Diagnosis	Countermeasure				
<div style="border: 1px solid black; padding: 5px; margin-bottom: 10px;">Save data for 30 minutes before stopping in Mente PC.</div> <pre> graph TD Q1{Is the connector of thermistor connected properly?} -- NO --> C1[Insert the connector securely.] Q1 -- YES --> Q2{Are the characteristics of thermistor OK? *3} Q2 -- NO --> C2[Replace thermistor (Tho-D1 or D2).] Q2 -- YES --> C3[Replace outdoor unit control PCB.] </pre>	<p>Check and save the data of operating condition. Check the conditions whether it occurs immediately after the power on or during operation or stopping. Check the sensed value. Compare the temperature on Mente PC with actual measured value.</p>				

2. Error detection method Detection of anomalously low temperature (resistance) of Tho-D1, D2.																																		
3. Condition of error displayed - If 3°C or lower is detected for 5 seconds continuously within 10 minutes to 10 minutes 20 seconds after the compressor ON, the compressor stops. And after 3 minutes delay, the compressor starts again automatically, but if this anomalous temperature is detected 3 times within 40 minutes after the initial detection.																																		
4. Presumable cause - Broken thermistor harness or the internal wire of sensing section. (Check the molded section as well) - Disconnection of thermistor harness connection (connector) - Outdoor unit control PCB anomaly.																																		
	Temperature-resistance characteristics of discharge pipe temperature thermistor (Tho-D1, D2)	Temperature (°C)	Temperature thermistor resistance (k)		------------------	---------------------------------------		0	180		20	100		40	60		60	40		80	30		100	25		120	22		140	21		160	20	

Note:

Error code Remote control: E40 7-segment display: E40	LED	Green	Red	Content High pressure anomaly (63H1-1, 2 activated)
	Indoor	Keeps flashing	Stays OFF	
	Outdoor	Keeps flashing	1-time flash	

1.Applicable model

Outdoor unit

2.Error detection method

When high pressure switch 63H1-1 or 63H1-2 is activated.

3. Condition of error displayed

- If high pressure exceeds 4.15MPa
- If 63H1-1, 2 is activated 5 times within 60 minutes
- If 63H1-1, 2 is activated for 60 minutes continuously

4.Presumable cause

- Short-circuit of airflow at condenser side of heat exchanger/Disturbance of airflow/Clogging filter/Fan motor anomaly
- Disconnection of high pressure switch connector
- Breakage of high pressure switch harness
- Closed service valves
- High pressure sensor anomaly
- High pressure switch anomaly

5.Troubleshooting

Diagnosis	Countermeasure
<div style="border: 1px solid black; padding: 5px; width: fit-content; margin: 0 auto;">Save data for 30 minutes before stopping in Mente PC.</div>	
<p>Was 63H1 or 63H1-2 activated at 4.15MPa or higher?</p> <p>NO</p> <p>YES</p> <p>Does the sensed value of the high pressure sensor show 4.15MPa? (Normal?)</p> <p>NO</p> <p>YES</p> <p>Are the 63H1-1, 2 OK? Are the connector and/or harness OK?</p> <p>NO</p> <p>YES</p> <p>Are the service valves fully open?</p> <p>NO</p> <p>YES</p> <p>Connect a pressure gauge and restart operation.</p> <p>Is it stop at 4.15MPa of gauge pressure?</p> <p>NO</p> <p>YES</p> <p>Is there any clogging in the refrigerant circuit?</p> <p>YES</p> <p>NO</p>	<p>Check and save the data of operating condition. Check the sensed value of high pressure sensor when the 63H1-1, 2 is activated. Check whether the high pressure switch is activated at the sensed value of high pressure sensor.</p> <p>High pressure sensor anomaly is suspicious. Check high pressure sensor itself according to the troubleshooting procedure of E54, after restarting operation. (If the high pressure sensor [PSH] fails, replace it)</p> <p>If the connector is disconnected or the harness is broken, correct it. Also check whether the high pressure switch is properly mounted or not. Check the open N phase on power source.</p> <p>Open operation valve.</p> <p>Check it, as much as possible, under the operating conditions for 30 minutes before error occurred.</p> <p>Replace outdoor unit control PCB.</p> <p>Remove clogs.</p> <p>Check items (condenser side):</p> <ul style="list-style-type: none"> • Filter clogging • Airflow volume (Fan motor) • Short-circuit of airflow

Note: If the error does not recur, connect the Maintenance PC and continue to collect data.

Error code Remote control: E41(E51) 7-segment display: E41(E51)-1, 2*1	LED	Green	Red	Content <h2 style="text-align: center;">Power transistor overheat</h2>
	Indoor	Keeps flashing	Stays OFF	
	Outdoor	Keeps flashing	*2	

*1 E41-1 (E51-1) : CM1, E41-2 (E51-2) : CM2 *2 E41-1 (E51-1) : 1-time flash, E41-2 (E51-2) : 2-time flash

<p>1.Applicable model</p> <p>Outdoor unit</p>	<p>5.Troubleshooting</p> <table border="1" style="width: 100%;"> <thead> <tr> <th style="width: 50%;">Diagnosis</th> <th style="width: 50%;">Countermeasure</th> </tr> </thead> <tbody> <tr> <td style="text-align: center;"> <div style="border: 1px solid black; padding: 2px; margin-bottom: 5px;">Save data for 30 minutes before stopping in Mente PC.</div> </td> <td></td> </tr> </tbody> </table>	Diagnosis	Countermeasure	<div style="border: 1px solid black; padding: 2px; margin-bottom: 5px;">Save data for 30 minutes before stopping in Mente PC.</div>	
Diagnosis	Countermeasure				
<div style="border: 1px solid black; padding: 2px; margin-bottom: 5px;">Save data for 30 minutes before stopping in Mente PC.</div>					
<p>2.Error detection method</p> <p>E41 is displayed on 7-segment LED.</p>					
<p>3. Condition of error displayed</p> <p>Anomalously high temperature of power transistor is detected 5 times within 60 minutes (E41). Or it is detected for 15 minutes continuously (E51).</p>					
<p>4.Presumable cause</p> <ul style="list-style-type: none"> • Power transistor anomaly • Power transistor temperature thermistor anomaly • Inverter PCB anomaly • Outdoor fan motor anomaly • Anomalous cooling fan motor for inverter 					

Note: *1 Measurement position: Between ① – ③ pins of CNN8
 *2 Measuring position: Between + and – of C19
 If it fails to repeat, connect the Mente PC, and continue to collect data.

Error code Remote control: E42 7-segment display: E42-1, 2*	LED	Green	Red	Content <h2 style="text-align: center;">Current cut (CM1, CM2)</h2>
	Indoor	Keeps flashing	Stays OFF	
	Outdoor	Keeps flashing	*2	

*1 E42-1: CM1, E42-2: CM2 *2 E42-1: 1-time flash, E42-2: 2-time flash

1. Applicable model	5. Troubleshooting		
Outdoor unit	Diagnosis	Countermeasure	
2. Error detection method			
When anomalously high output current of inverter is detected by the current sensor mounted in the power transistor.			
3. Condition of error displayed			
When 88A or higher output current of inverter is detected 4 times within 15 minutes.			
4. Presumable cause	<ul style="list-style-type: none"> • Compressor anomaly • Leakage of refrigerant • Power transistor module anomaly • Anomalous power source for inverter PCB • Outdoor fan motor anomaly 		

Note: *3 Measurement position: Between + and - of C19

*4 Measurement position: Check resistance between P-U, P-V, P-W, N-U, N-V, N-W, P-N. (Disconnect compressor wires before measurement). If it fails to repeat, connect the Mente PC, and continue to collect data.

Error code Remote control: E43 7-segment display: E43-1, 2 *1	LED	Green	Red	Content Excessive number of indoor units connected, excessive total capacity of connection
	Indoor	Keeps flashing	Stays OFF	
	Outdoor	Keeps flashing	*1	

*1 E43-1/1-time flash: Excessive number of indoor units connected, E43-2/2-time flash: Excessive capacity of connection

1. Applicable model Outdoor unit	5. Troubleshooting																		
2. Error detection method When the number of connected indoor units exceeds the limitation. When the total capacity of connected indoor units exceeds the limitation.	<table border="1" style="width: 100%;"> <thead> <tr> <th style="width: 50%;">Diagnosis</th> <th style="width: 50%;">Countermeasure</th> </tr> </thead> <tbody> <tr> <td style="text-align: center;"> Save data for 30 minutes before stopping in Mente PC. </td> <td style="vertical-align: top;"> Check and save the data of operating condition. </td> </tr> <tr> <td style="text-align: center;"> Reset the power. </td> <td style="vertical-align: top;"> <div style="border: 1px solid black; padding: 2px; width: fit-content; margin-bottom: 5px;"> Caution: Address will not be confirmed, unless the power is reset after changing address. </div> </td> </tr> <tr> <td style="text-align: center;"> Is E43 displayed? </td> <td style="vertical-align: top;"> NO → Test run. No action is taken because it is judged that the power reset was not done after changing address. </td> </tr> <tr> <td style="text-align: center;"> YES → Does the number of indoor units connected and/or total capacity exceed limitation? </td> <td style="vertical-align: top;"> YES → Check indoor unit addresses and correct. In case that total capacity of connected indoor units exceeds the limitation, </td> </tr> <tr> <td style="text-align: center;"> NO → Check the connected number of indoor units with 7-segment display code C50 or Mente PC with reference to the utilities drawing. (Check not only one system, but also other systems) </td> <td style="vertical-align: top;"> NO → Are there any indoor units which is not expected to exist in that signal line? </td> </tr> <tr> <td style="text-align: center;"> YES → Are there any indoor units which is not expected to exist in that signal line? </td> <td style="vertical-align: top;"> YES → Signal wire may be connected to other outdoor unit system. Correct the signal wire. </td> </tr> <tr> <td style="text-align: center;"> NO → Check the resistance between A and B of signal line as well. </td> <td style="vertical-align: top;"> NO → Correct addresses. (Either one of addresses is wrong.) If the address corrected with rotary switch is still wrong, replace control PCB. (Defective rotary switch) </td> </tr> <tr> <td style="text-align: center;"> General checking of indoor/outdoor unit addresses by means of: ◇ Outdoor unit: Mente PC, 7-Segment display and rotary switch (SW1, 2) ◇ Indoor unit: Remote control, rotary switch (SW1, 2, 3, 4) * It is recommended to use means other than the rotary switch which could be defective. </td> <td style="vertical-align: top;"> * Before replacement, please confirm whether the rotary switch for address setting is not damaged. </td> </tr> </tbody> </table>	Diagnosis	Countermeasure	Save data for 30 minutes before stopping in Mente PC.	Check and save the data of operating condition.	Reset the power.	<div style="border: 1px solid black; padding: 2px; width: fit-content; margin-bottom: 5px;"> Caution: Address will not be confirmed, unless the power is reset after changing address. </div>	Is E43 displayed?	NO → Test run. No action is taken because it is judged that the power reset was not done after changing address.	YES → Does the number of indoor units connected and/or total capacity exceed limitation?	YES → Check indoor unit addresses and correct. In case that total capacity of connected indoor units exceeds the limitation,	NO → Check the connected number of indoor units with 7-segment display code C50 or Mente PC with reference to the utilities drawing. (Check not only one system, but also other systems)	NO → Are there any indoor units which is not expected to exist in that signal line?	YES → Are there any indoor units which is not expected to exist in that signal line?	YES → Signal wire may be connected to other outdoor unit system. Correct the signal wire.	NO → Check the resistance between A and B of signal line as well.	NO → Correct addresses. (Either one of addresses is wrong.) If the address corrected with rotary switch is still wrong, replace control PCB. (Defective rotary switch)	General checking of indoor/outdoor unit addresses by means of: ◇ Outdoor unit: Mente PC, 7-Segment display and rotary switch (SW1, 2) ◇ Indoor unit: Remote control, rotary switch (SW1, 2, 3, 4) * It is recommended to use means other than the rotary switch which could be defective.	* Before replacement, please confirm whether the rotary switch for address setting is not damaged.
Diagnosis	Countermeasure																		
Save data for 30 minutes before stopping in Mente PC.	Check and save the data of operating condition.																		
Reset the power.	<div style="border: 1px solid black; padding: 2px; width: fit-content; margin-bottom: 5px;"> Caution: Address will not be confirmed, unless the power is reset after changing address. </div>																		
Is E43 displayed?	NO → Test run. No action is taken because it is judged that the power reset was not done after changing address.																		
YES → Does the number of indoor units connected and/or total capacity exceed limitation?	YES → Check indoor unit addresses and correct. In case that total capacity of connected indoor units exceeds the limitation,																		
NO → Check the connected number of indoor units with 7-segment display code C50 or Mente PC with reference to the utilities drawing. (Check not only one system, but also other systems)	NO → Are there any indoor units which is not expected to exist in that signal line?																		
YES → Are there any indoor units which is not expected to exist in that signal line?	YES → Signal wire may be connected to other outdoor unit system. Correct the signal wire.																		
NO → Check the resistance between A and B of signal line as well.	NO → Correct addresses. (Either one of addresses is wrong.) If the address corrected with rotary switch is still wrong, replace control PCB. (Defective rotary switch)																		
General checking of indoor/outdoor unit addresses by means of: ◇ Outdoor unit: Mente PC, 7-Segment display and rotary switch (SW1, 2) ◇ Indoor unit: Remote control, rotary switch (SW1, 2, 3, 4) * It is recommended to use means other than the rotary switch which could be defective.	* Before replacement, please confirm whether the rotary switch for address setting is not damaged.																		
3. Condition of error displayed <ul style="list-style-type: none"> Excessive number of connected indoor units Excessive total capacity of connected indoor units The total capacity of connected indoor units exceeds the limitation 																			
4. Presumable cause <ul style="list-style-type: none"> Mistake in setting of indoor/outdoor unit addresses Mistake in signal wire connection 																			

Note: After completing the above procedure, reset the power and confirm that the error display does not recur. Unless the power is reset for both indoor unit and outdoor unit, the set addresses will not be confirmed.

Error code Remote control: E44 7-segment display: E44-1, 2 *1	LED	Green	Red	Content Liquid flooding anomaly (CM1, CM2)
	Indoor	Keeps flashing	Stays OFF	
	Outdoor	Keeps flashing	*2	

*1 E44-1: CM1, E44-2 : CM2 *2 E44-1: 1-time flash, E45-2: 2-time flash

1.Applicable model
Outdoor units
2.Error detection method
When 5°C or lower of the under-dome temperature superheat is detected for 15 minutes continuously or for 30 minutes continuously.
3. Condition of error displayed
When above anomaly is detected 3 times within 90 minutes.
4.Presumable cause
<ul style="list-style-type: none"> • Unmatching of refrigerant piping and/or signal wiring • Overcharging of refrigerant • Anomalous control of superheat • Anomalous circuit of liquid refrigerant by-pass • Anomalous refrigerant circuit of subcooling coil • Under-dome temperature (Tho-D1, 2) anomaly

5.Troubleshooting	Diagnosis	Countermeasure
	<div style="border: 1px solid black; padding: 2px; width: fit-content; margin: 0 auto;">Save data for 30 minutes before stopping in Mente PC.</div>	<p>Check and save the data of operating condition. Check the ROM version. Confirmation of SV1, 2 operation.</p> <p>Correct the connection of refrigerant piping and/or signal wiring properly.</p> <p>Adjust refrigerant amount properly.</p> <p>Replace SV1, 2. Replace the coil of SV1, 2.</p> <ul style="list-style-type: none"> • Replace EEVSC. • Check the coil of EEVSC → Replace the coil of EEVSC • Replace Tho-H. • Replace PSL. <ul style="list-style-type: none"> • Replace indoor EEV. • Check the coil of EEV → Replace the coil of EEV. • Check the installed position of Thi-R1, R2, R3 → Replace Thi-R, if necessary. • Check the air filter. • Check the connection of indoor fan motor connector. Replace indoor fan motor * By checking Thi-R1, R2, R3 from indoor unit operation data of Mente PC, specify the indoor unit which tends to be liquid flooding (Thi-R3=Thi-R2 shows the probability of liquid flooding) <ul style="list-style-type: none"> • Replace EEVH1, 2, 3. • Check the coil of EEVH1, 2, 3 → Replace the coil of EEVH1, 2, 3. • Check the installed position of Thi-R1, R2, R3 → Replace Tho-R, if necessary. • Clean the fin of outdoor heat exchanger. • Check the connection of outdoor fan motor connector Replace outdoor fan motor. <p>• Replace Tho-C1, 2.</p> <p>Correct the data with Mente PC and ask our consultation.</p>

Note: If the error does not recur, connect the Mente PC and continue to collect data.

Error code Remote control: E45 7-segment display: E45-1, 2 *1	LED	Green	Red	Content Communication error between inverter PCB and outdoor unit control PCB(1/2)
	Indoor	Keeps flashing	Stays OFF	
	Outdoor	Keeps flashing	*2	

*1 E45-1: INV1, E45-2: INVI *2 E45-1: 1-time flash, E45-2: 2-time flash

1. Applicable model	Outdoor unit
2. Error detection method	E45 is displayed on 7-segment LED.
3. Condition of error displayed	When communication is not established between inverter and control PCB.
4. Presumable cause	<ul style="list-style-type: none"> Defective communication cable Defective inverter PCB Defective control PCB Defective surge suppressor resistor Defective 52X Defective diode module

5. Troubleshooting (When E45-1 and E45-2 occur simultaneously, inspect INV1 also for E45-2 in order to display E45-2.)

Diagnosis	Countermeasure
<p>Save the data obtained 30 minutes before stop in the maintenance PC.</p> <p>Reset the power source, and restart.</p> <p>Does it repeat?</p> <p>NO → Wait and see.</p> <p>YES → Turn power OFF, and check the connection of harness and connectors between the inverter and control PCBs. When CNI3 was disconnected for inspection, make sure to reconnect it.</p> <p>NO → Broken wire: Replace harness. Disconnection, misconnection: Correct.</p> <p>YES → Power ON</p> <p>Is DC15V power source detected on control PCB?</p> <p>NO → Replace control PCB.</p> <p>YES → E45-1?</p> <p>NO → Turn power OFF. Disconnect CNI3 harness from the line 1 inverter PCB, and turn power ON again.</p> <p>E45-1?</p> <p>NO → See next page. A</p> <p>YES → Is the green or red LED on the line 1 inverter PCB blinking or lighting?</p> <p>NO → Confirm that 52X1-1, 52X1-2, 52X1-3 and 52X1-4 are turned ON, and check if DC280V is detected between P-N of line 1 power transformer.</p> <p>YES → Replace line 1 inverter PCB.</p> <p>NO → Does 52X of line 1 turn ON?</p> <p>NO → If power is not turned ON even after turning it ON from the maintenance PC, check the voltage at connectors (※5) on the control PCB. If AC200V is detected, replace 52X. If it is 0V, replace the control PCB unless harness wires are broken.</p> <p>YES → Power OFF</p> <p>Is the line 1 surge suppressor resistor coil broken?</p> <p>YES → Disconnect the harness from the resistor, and check the resistance value between terminals. If any wire is broken, replace suppressor.</p> <p>NO → Is the line 1 diode module short-circuited or its wire broken?</p> <p>YES → Replace line 1 diode module. For inspection method, see page 136.</p> <p>NO → Are SWs set properly on the line 1 inverter PCB?</p> <p>NO → Correct the setting of switches on line 1 inverter PCB.</p> <p>YES → Replace line 1 inverter PCB. If error persists still, replace control PCB.</p>	

Note: ※3 Measurement position: Between 1 – 2 of CNI1 or 1 - 2 of CNZ.
 ※4 Measurement position: Between + and - of C13 or 2 -3 of IC3. Between both ends of C79 or 2 – 3 of CNI3.
 ※5 Measurement position: Between ① - ③ of CNM1 and CNM2 (For CNM2, systems with 2 compressors only).
 When it does not reproduce, connect the maintenance PC and continue to acquire data.

Error code Remote control: E45 7-segment display: E45-1, 2 *1	LED	Green	Red	Content Communication error between inverter PCB and outdoor unit control PCB(2/2)
	Indoor	Keeps flashing	Stays OFF	
	Outdoor	Keeps flashing	*2	

*1 E45-1: INV1, E45-2: INVI *2 E45-1: 1-time flash, E45-2: 2-time flash

1. Applicable model
Outdoor unit
2. Error detection method
E45 is displayed on 7-segment LED.
3. Condition of error displayed
When communication is not established between inverter and control PCB.
4. Presumable cause
<ul style="list-style-type: none"> Defective communication cable Defective inverter PCB Defective control PCB Defective surge suppressor resistor Defective 52X Defective diode module

5. Troubleshooting (When E45-1 and E45-2 occur simultaneously, inspect INV1 also for E45-2 in order to display E45-2.)	
Diagnosis	Countermeasure

Note: *3 Measurement position: Between 1 – 2 of CNI1 or 1 - 2 of CNZ.
 *4 Measurement position: Between + and - of C13 or 2 -3 of IC3. Between both ends of C79 or 2 – 3 of CNI3.
 *5 Measurement position: Between ① - ③ of CNM1 and CNM2 (For CNM2, systems with 2 compressors only).
 When it does not reproduce, connect the maintenance PC and continue to acquire data.

Error code Remote control: E46 7-segment display: E46	LED	Green	Red	Content Mixed address setting methods coexistent in same network
	Indoor	Keeps flashing	Stays OFF	
	Outdoor	Keeps flashing	Stays OFF	

1. Applicable model

Outdoor unit

2. Error detection method

If the signal line of a outdoor unit system applied automatic address setting is connected to other outdoor unit system. (Detected at indoor unit side)

3. Condition of error displayed

Same as above.

4. Presumable cause

- Mistake in the address setting
- Mistake in the connection of signal wire

5. Troubleshooting

Diagnosis	Countermeasure									
<p>Save data for 30 minutes before stopping in Mente PC.</p> <p>Reset power source and restart.</p> <p>Does E46 recur?</p> <p>NO</p> <p>YES</p> <p>Isn't the signal line of a outdoor unit system applying automatic address setting connected to other outdoor unit system?</p> <p>YES</p> <p>NO</p> <p>If signal line is connected to more than 2 outdoor unit systems, address setting should be done by manually.</p> <p>Is E46 still displayed?</p> <p>NO</p> <p>YES</p> <p>Turn ON the power of each outdoor unit one by one and search the outdoor unit that can start up with automatic address setting.</p> <p><Reference> Error display at mixed address setting</p> <table border="1"> <tr> <td></td> <td>Auto</td> <td>Manual</td> </tr> <tr> <td>Auto address setting</td> <td>E31</td> <td>E46</td> </tr> <tr> <td>Manual address setting</td> <td>E46</td> <td>Normal</td> </tr> </table>		Auto	Manual	Auto address setting	E31	E46	Manual address setting	E46	Normal	<p>Check and save the data of operating conditions. Check the address setting method of faulty network whether it is automatic setting or manual setting.</p> <p>Caution: Unless the power is reset after changing address, the set address will not be confirmed.</p> <p>Test run. * No action is taken because it is judged that the power reset is not done after changing address.</p> <p>Correct signal line. *In case of automatic address setting, signal line cannot be connected to other outdoor unit system.</p> <p>Test run.</p> <p>Replace outdoor unit control PCB*. (Rotary switch anomaly)</p> <p>* Before replacement, please confirm whether the rotary switch for address setting is not damaged.</p>
	Auto	Manual								
Auto address setting	E31	E46								
Manual address setting	E46	Normal								

Note: After completing the above procedure, reset the power and confirm that the error display does not recur. Unless the power is reset for both indoor unit and outdoor unit, the set addresses will not be confirmed.

Error code Remote control: E48 7-segment display: E48-1, 2 *1	LED	Green	Red	Content <h2 style="text-align: center;">Outdoor DC fan motor anomaly(1/2)</h2>
	Indoor	Keeps flashing	Stays OFF	
	Outdoor	Keeps flashing	*2	

*1 E48-1: 1-time flash (FMo1), E48-2 : 2-time flash (FMo2) *2 E48-1: 1-time flash, E48-2: 2-time flash

1.Applicable model	5.Troubleshooting (Check also the fan motor 2, even if it is E48-1, and also the fan motor 1, even if it is E48-2.)		
Outdoor unit	Diagnosis	Countermeasure	
2.Error detection method			
(1) Fan rotation speed of 100 min ⁻¹ or lower is detected for 30 seconds.			
3. Condition of error displayed			
When the error detection method (1) occurred 5 times in 60 minutes.			
4.Presumable cause	<ul style="list-style-type: none"> • Broken or disconnected wire • Faulty fan motor • Defective control PCB 		

Note: ※3 Measurement position Connector of fan motor power cable
 ※4 Refer to resistance values in separate table. (See next page.)
 ※5 Measurement position Between 2-3 pins of IC3 on control PCB or between 1-6 pins of CNFAN connector on control PCB
 When it does not reproduce, connect the maintenance PC and continue to acquire data.

Error code Remote control: E48 7-segment display: E48-1, 2 *1	LED	Green	Red	Content <h2 style="text-align: center;">Outdoor DC fan motor anomaly(2/2)</h2>
	Indoor	Keeps flashing	Stays OFF	
	Outdoor	Keeps flashing	*2	

*1 E48-1: 1-time flash (FMo1), E48-2 : 2-time flash (FMo2) *2 E48-1: 1-time flash, E48-2: 2-time flash

1. Applicable model Outdoor unit	5. Troubleshooting (Check also the fan motor 2, even if it is E48-1, and also the fan motor 1, even if it is E48-2.)		
2. Error detection method (1) Fan rotation speed of 100 min ⁻¹ or lower is detected for 30 seconds.	Diagnosis		Countermeasure
3. Condition of error displayed When the error detection method (1) occurred 5 times in 60 minutes.			Replace control PCB. Replace fan motor. Replace control PCB. Replace fan motor. Replace fan motor. Wait and see.
4. Presumable cause <ul style="list-style-type: none"> Broken or disconnected wire Faulty fan motor Defective control PCB 			

Note: ※5 Measurement position Between 2-3 pins of IC3 on control PCB or between 1-6 pins of CNFAN connector on control PCB
 ※6 Speed command voltage 0-5 [V]
 ※7 Check with the maintenance PC or 7-segment.
 If it does not reproduce, connect the maintenance PC and continue to acquire data.

Separate table: Fan motor resistance value (Reference value ※)

Type 4 (Upward blow)

Measurement position				Fan motor part No.	
				SSA512T100	SSA512T101
Power line		Red	Vm	> 1 [MΩ]	> 1 [MΩ]
Control	1 pin	White	Vcc	7.7 [kΩ] ± 20%	7.7 [kΩ] ± 20%
	2 pin	Orange	REV	> 1 [MΩ]	> 1 [MΩ]
	3 pin	Yellow	Vsp	200 [kΩ] ± 20%	200 [kΩ] ± 20%
	4 pin	Blue	FG	> 1 [MΩ]	> 1 [MΩ]
	5 pin	Green	OVERC	> 1 [MΩ]	> 1 [MΩ]
	6 pin	Pink	GND	-	-

※Measurement values may vary depending on measurement instruments. Values in the table are only for inspection of obvious errors such as short-circuit, etc., and not for judgment of acceptability of devices.

Error code Remote control: E49 7-segment display: E49	LED	Green	Red	Content <h2 style="text-align: center;">Low pressure anomaly</h2>
	Indoor	Keeps flashing	Stays OFF	
	Outdoor	Keeps flashing	1-time flash	

1. Applicable model
Outdoor unit
2. Error detection method
Detection of anomalously low pressure.
3. Condition of error displayed
<ul style="list-style-type: none"> • During operation: When the low pressure sensor detects lower than 0.003MPa for 5 seconds continuously. And if this anomaly occurs 2 times. When the low pressure sensor detects 0.134MPa or lower for 30 seconds continuously. And if this anomaly occurs 5 times within 60 minutes.
4. Presumable cause
<ul style="list-style-type: none"> • Low pressure sensor (PSL) anomaly • Service valves closed • EEV anomaly (EEV closed) • Insufficient refrigerant amount • Clogging at EEV or strainer

5. Troubleshooting	
Diagnosis	Countermeasure
<p>Save data for 30 minutes before stopping in Mente PC.</p> <p>Reset power source and restart.</p> <p>Does the error occur immediately after the startup?</p> <p>YES → Check whether the service valves are open.</p> <p>NO → Does the low pressure fluctuate after the startup?</p> <p>NO → Is the connection of sensor connector OK?</p> <p>NO → Correct the connection of low pressure sensor connector.</p> <p>YES → Are the sensor characteristics OK?*</p> <p>NO → Replace low pressure sensor.</p> <p>YES → Replace outdoor unit control PCB.</p> <p>* The sensor characteristics is shown in page 124.</p> <p>NO → Is the opening degree of EEV for evaporator side fluctuating?</p> <p>NO → Is the connection of thermistor connector for heat exchanger OK?</p> <p>NO → Correct the connection of temperature thermistor connector of heat exchanger.</p> <p>YES → Is the checked result of harness and insulation of EEV coil OK?</p> <p>NO → Are the thermistor characteristics OK?</p> <p>NO → Replace temperature thermistor of heat exchanger at evaporator side.</p> <p>YES → Replace control PCB at evaporator side.</p> <p>NO → Replace EEV coil.</p> <p>YES → Does the EEV operate normally by judging from Mente PC data, etc?</p> <p>NO → Isn't EEV or strainer clogged?</p> <p>YES → Replace EEV main body or strainer.</p> <p>NO → Check for short circuit of airflow of heat exchanger at evaporator side and for fan motor anomaly.</p>	

Note: Check whether the indoor unit is connected to other outdoor Superlink network.
If the error does not recur, connect the Mente PC and continue to collect data.

Error code Remote control: E53/E55*1 7-segment display: E53/E55-1, 2	LED	Green	Red	Content Suction pipe temperature thermistor anomaly (Tho-S), Under-dome temperature thermistor anomaly (Tho-C1, C2)
	Indoor	Keeps flashing	Stays OFF	
	Outdoor	Keeps flashing	*2	

*1 E55-1 : Tho-C1, E55-2: Tho-C2 *2 E53 : E53-E55-1-time flash, E55-2: 2-time flash

<p>1.Applicable model</p> <p>Outdoor unit</p>	5.Troubleshooting		
<p>2.Error detection method</p> <p>Detection of anomalously low temperature (resistance) of Tho-S or Tho-C1, C2.</p>	Diagnosis		Countermeasure
<p>3. Condition of error displayed</p> <ul style="list-style-type: none"> if -50°C or lower is detected for 5 seconds continuously within 2 minutes to 2 minutes 20 seconds after compressor ON, compressor stops. When the compressor is restarted automatically after 3-minutes delay, if this anomaly occurs 3 times within 40 minutes. 	<div style="border: 1px solid black; padding: 5px; width: fit-content; margin: 0 auto;">Save data for 30 minutes before stopping in Mente PC.</div> <p style="text-align: center;">※1 Check several times to prove any poor connection.</p>		<p>Check and save the data of operating conditions. Check the conditions whether it occurs immediately after the power on or during operation or stopping. Check the sensed value. Compare the temperature on Mente PC with actual measured value.</p> <p>Insert the connector securely.</p> <p>Replace thermistor. (Tho-S or Tho-C1, C2)</p> <p>Replace outdoor unit control PCB.</p>
<p>4.Presumable cause</p> <ul style="list-style-type: none"> Broken thermistor harness or the internal wire of sensing section (Check the molded section as well) Disconnection of thermistor harness connection (connector) Outdoor unit control PCB anomaly 	<div style="display: flex; justify-content: space-around;"> <div style="text-align: center;"> <p>Temperature-resistance characteristics of suction pipe temperature thermistor (Tho-S)</p> </div> <div style="text-align: center;"> <p>Temperature-resistance characteristics of under-dome temperature thermistor (Tho-C1, C2)</p> </div> </div>		

Note:

Error code Remote control: E54 7-segment display: E54-1, 2 *1	LED	Green	Red	Content High pressure sensor anomaly (PSH) Low pressure sensor anomaly (PSL)
	Indoor	Keeps flashing	Stays OFF	
	Outdoor	Keeps flashing	*1	

*1 E54-1: 1-time flash (PSL), E54-2 : 2-time flash (PSH)

1.Applicable model
Outdoor unit
2.Error detection method
Detection of anomalous pressure (voltage) of PSH or PSL. [Operation range High pressure : 0-4.15MPa Low pressure : 0-1.7MPa]
3. Condition of error displayed
If anomalous sensor output voltage (0V or lower or 3.49V or higher) is detected for 5 seconds within 2 minutes to 2 minutes 20 seconds after the compressor ON.
4.Presumable cause
<ul style="list-style-type: none"> • Broken sensor harness • Disconnection of sensor harness connection (connector) • Sensor (PSH, PSL) anomaly • Outdoor unit control PCB anomaly • Anomalous installation conditions • Insufficient airflow volume • Excessive or insufficient refrigerant amount

5.Troubleshooting	
Diagnosis	Countermeasure
<p>Save data for 30 minutes before stopping in Mente PC.</p> <p>Check the data for 30 minutes before stopping.</p> <p>Is anomalous pressure detected?</p> <p>NO → Reset the power and restart operation.</p> <p>YES → Is the connector of the sensor inserted properly to the connector on the outdoor control PCB?</p> <p>NO → Insert the connector securely and restart operation.</p> <p>YES → Does E54 recur?</p> <p>NO → Temporary malfunction by noise. Correct if the source of noise is specified.</p> <p>YES → Does the pressure converted from the sensor output voltage match the actual pressure measure by pressure gauge?</p> <p>NO → Replace sensor (PSH, PSL)</p> <p>YES → Replace outdoor unit control PCB.</p>	
<div style="display: flex; justify-content: space-around;"> <div style="text-align: center;"> <p>High pressure sensor output characteristics</p> <p>Output voltage (V)</p> <p>Pressure (MPa)</p> </div> <div style="text-align: center;"> <p>Low pressure sensor output characteristics</p> <p>Output voltage (V)</p> <p>Pressure (MPa)</p> </div> </div> <p>Sensor output Black (GND) – White; Output voltage (Black – Red; DC5V)</p>	

Note:

Error code Remote control: E56 7-segment display: E56-1, 2 *1	LED	Green	Red	Content Power transistor temperature thermistor anomaly (Tho-P1, P2)
	Indoor	Keeps flashing	Stays OFF	
	Outdoor	Keeps flashing	*1	

*1 E56-1/1-time flash: Tho-P1 anomaly, E56-2/2-time flash: Tho-P2-anomaly

1. Applicable model Outdoor unit	5. Troubleshooting				
2. Error detection method Detection of anomalously low temperature (resistance) of Tho-P1, P2.	<table border="1" style="width: 100%;"> <thead> <tr> <th style="width: 50%;">Diagnosis</th> <th style="width: 50%;">Countermeasure</th> </tr> </thead> <tbody> <tr> <td style="vertical-align: top;"> <div style="border: 1px solid black; padding: 5px; margin-bottom: 10px;">Save data for 30 minutes before stopping in Mente PC.</div> <p style="text-align: center;">※1 Check several times to prove any poor connection.</p> <div style="text-align: center;"> <p>Temperature-resistance characteristics of power transistor temperature thermistor (Tho-P1, P2)</p> </div> </td> <td style="vertical-align: top;"> <p>Check and save the data of operating condition. Check the conditions whether it occurs immediately after the power on or during operation or stopping. Check the sensed value. Compare the temperature of Mente PC data with actual measured value.</p> <p>Insert the connector securely.</p> <p>Replace power transistor temperature thermistor (Tho-P1, P2).</p> <p>Replace outdoor unit control PCB.</p> </td> </tr> </tbody> </table>	Diagnosis	Countermeasure	<div style="border: 1px solid black; padding: 5px; margin-bottom: 10px;">Save data for 30 minutes before stopping in Mente PC.</div> <p style="text-align: center;">※1 Check several times to prove any poor connection.</p> <div style="text-align: center;"> <p>Temperature-resistance characteristics of power transistor temperature thermistor (Tho-P1, P2)</p> </div>	<p>Check and save the data of operating condition. Check the conditions whether it occurs immediately after the power on or during operation or stopping. Check the sensed value. Compare the temperature of Mente PC data with actual measured value.</p> <p>Insert the connector securely.</p> <p>Replace power transistor temperature thermistor (Tho-P1, P2).</p> <p>Replace outdoor unit control PCB.</p>
Diagnosis	Countermeasure				
<div style="border: 1px solid black; padding: 5px; margin-bottom: 10px;">Save data for 30 minutes before stopping in Mente PC.</div> <p style="text-align: center;">※1 Check several times to prove any poor connection.</p> <div style="text-align: center;"> <p>Temperature-resistance characteristics of power transistor temperature thermistor (Tho-P1, P2)</p> </div>	<p>Check and save the data of operating condition. Check the conditions whether it occurs immediately after the power on or during operation or stopping. Check the sensed value. Compare the temperature of Mente PC data with actual measured value.</p> <p>Insert the connector securely.</p> <p>Replace power transistor temperature thermistor (Tho-P1, P2).</p> <p>Replace outdoor unit control PCB.</p>				
3. Condition of error displayed When the outdoor air temperature is above 0°C, if -10°C or lower is detected for 20 seconds continuously within 10 minutes to 10 minutes 30 seconds after compressor ON, compressor stops. When the compressor is restarted automatically after 3 minutes delay, if this anomaly occurs 3 times within 40 minutes.					
4. Presumable cause <ul style="list-style-type: none"> • Broken thermistor harness or the internal wire of sensing section (Check the molded section as well) • Disconnection of thermistor harness connection (connector) • Outdoor unit control PCB anomaly 					

Note:

Error code Remote control: E58 7-segment display: E58-1, 2 *1	LED	Green	Red	Content <h2 style="text-align: center;">Anomalous compressor by loss of synchronism</h2>
	Indoor	Keeps flashing	Stays OFF	
	Outdoor	Keeps flashing	*2	

*1 E58-1: CM1, E58-2: CM2 *2 E58-1: 1-time flash, E58-2: 2-time flash

1. Applicable model	5. Troubleshooting		
Outdoor unit	Diagnosis	Countermeasure	
2. Error detection method			
E58 is displayed on 7-segment LED.			
3. Condition of error displayed			
This anomaly is established 4 times within 15 minutes.			
4. Presumable cause	<ul style="list-style-type: none"> • Insufficient time elapsed after the power supplied, before compressor startup. (Startup the compressor without crankcase heater ON) • Compressor anomaly • Inverter PCB anomaly • Power transistor anomaly 		

Note: *3 Measurement position: Between + and - of C19
 *4 Measurement position: Check resistance between P-U, P-V, P-W, N-U, N-V, N-W, P-N. (Disconnect wires from compressor beforehand.)
 If it fails to repeat, connect the Mente PC, and continue to collect data.

Error code Remote control: E59 7-segment display: E59-1, 2 *1	LED	Green	Red	Content <h2 style="text-align: center;">Compressor startup failure (CM1,CM2)</h2>
	Indoor	Keeps flashing	Stays OFF	
	Outdoor	Keeps flashing	*2	

*1 E59-1: CM1, E59-2: CM2 *2 E59-1: 1-time flash, E59-2: 2-time flash

1.Applicable model
Outdoor unit
2.Error detection method
When it fails to change over to the operation for rotor position detection of compressor motor.
3. Condition of error displayed
If the compressor fails to startup for 20 times (10 patterns x 2 times) continuously.
4.Presumable cause
<ul style="list-style-type: none"> Anomalous voltage of power source Anomalous components for refrigerant circuit Inverter PCB anomaly Loose connection of connector or cable Compressor anomaly (Motor or bearing)

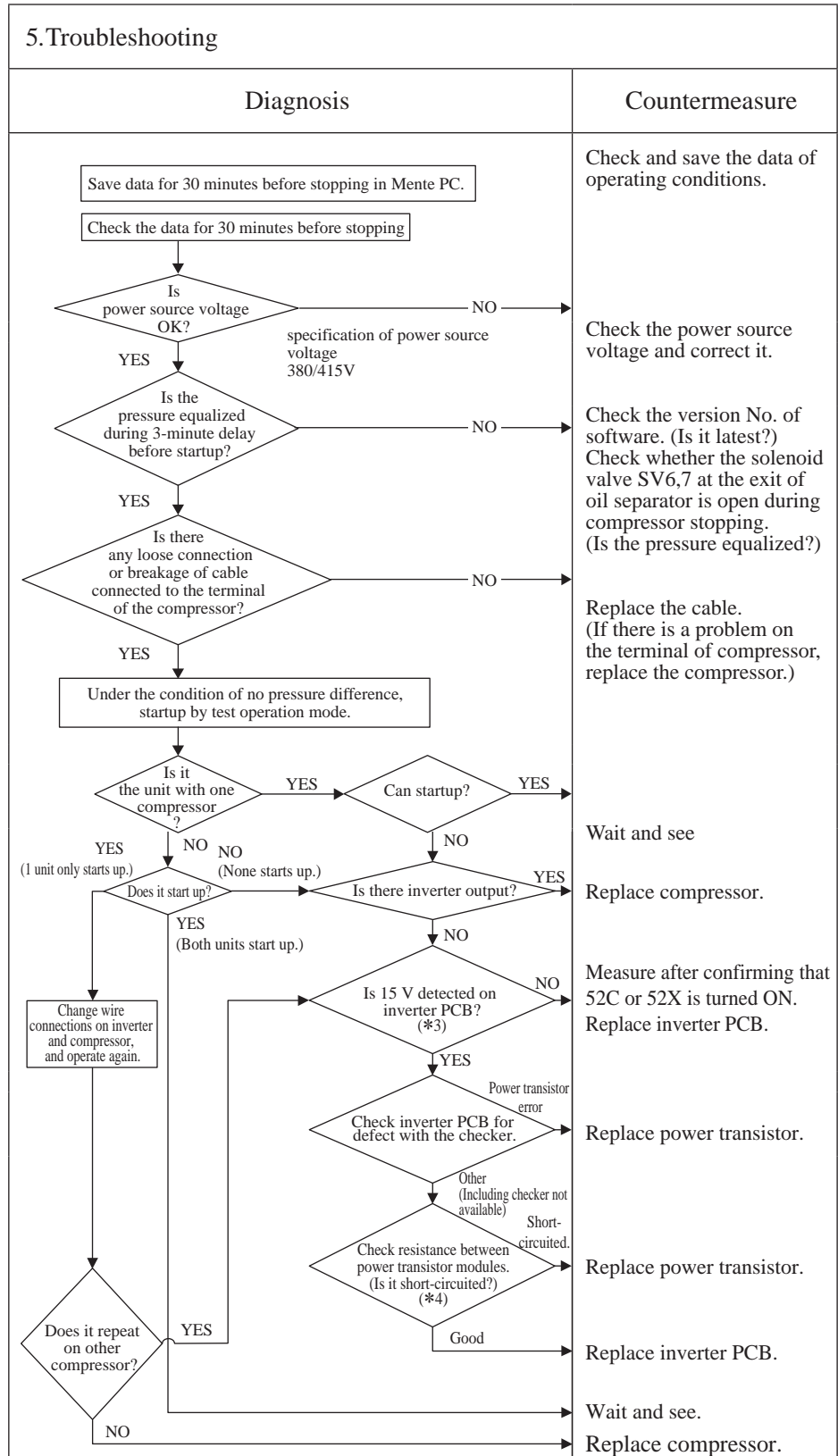

Note: *3 Measurement position: Between + and - of C19
 *4 Measurement position: Check resistance between P-U, P-V, P-W, N-U, N-V, N-W, P-N. (Disconnect wires from compressor beforehand.)
 If it fails to repeat, connect the Mente PC, and continue to collect data.

Error code Remote control: E63 7-segment display: E63	LED	Green	Red	Content <h2 style="text-align: center;">Emergency stop</h2>
	Indoor	Keeps flashing	Stays OFF	
	Outdoor	Keeps flashing	1-time flash	

1.Applicable model
Indoor unit

2.Error detection method
When ON signal is inputted to the CnT terminal of indoor control PCB.

3. Condition of error displayed
Same as above

4.Presumable cause
Factors for emergency stop

5.Troubleshooting	
Diagnosis	Countermeasure
<div style="border: 1px solid black; padding: 5px; margin-bottom: 10px;">Save data for 30 minutes before stopping in Mente PC.</div> <pre> graph TD A{Is the remote controller setting of Emergency Stop "Valid"?} -- NO --> B[Replace remote control PCB.] A -- YES --> C{Is ON signal inputted to the CnT terminal of indoor control PCB?} C -- NO --> D[Replace indoor unit control PCB.] C -- YES --> E[Check the cause of emergency stop. (It is better to have the data for 30 minutes before stopping, when instructing the installer)] </pre>	
	Check and save the data of operating conditions. Check the conditions whether it occurs immediately after the power on or during operation.

Note: Indoor unit detected emergency stop signal gives command "all stop"

2.4 Outdoor unit control PCB replacement procedure

PCB012D046A

Precautions for Safety

- Since the following precaution is the important contents for safety, be sure to observe them. WARNING and CAUTION are described as follows:

- ⚠ **WARNING** Indicates an imminently hazardous situation which will result in death or serious injury if proper safety procedures and instructions are not adhered to.
- ⚠ **CAUTION** Indicates a potentially hazardous situation which may result in minor or moderate injury if proper safety procedures and instructions are not adhered to.

⚠ WARNING

- Securely replace PCB according to this following instruction. If PCB is incorrectly replace, it will cause an electric shock or fire.
- Be sure to check that the power source for the outdoor unit is turned OFF before replacing PCB, The PCB replacement under current-carrying will cause an electric shock.
- After finishing PCB replacement, check that wiring is correctly connected with the PCB before power distribution. If the PCB is incorrectly replaced, it will cause an electric shock or fire.

⚠ CAUTION

- Bundle the wiring so as not to tense because it will cause an electric shock.

Exchange the control PCB according to the following procedure.

1. Exchange the PCB **after elapsing 3 minutes from power OFF.**

(Be sure to measure voltage (DC) and check that the voltage is discharged sufficiently. (Refer to Fig.1))

2. Disconnect the connectors from the PCB.
3. Disconnect the blue wiring passing through CT1 and CT2 on the PCB before exchanging the PCB.
4. Match the setting switches (SW1-6) and jumper wires (J11-J16) with the former PCB.
5. Tighten up a screw after passing blue wiring through CT1 and CT2 of the changed. (If the CT2 is not assembled, only CT1.)
6. Connect the connectors to the PCB. (Confirm the **connectors are not half inserted.**)

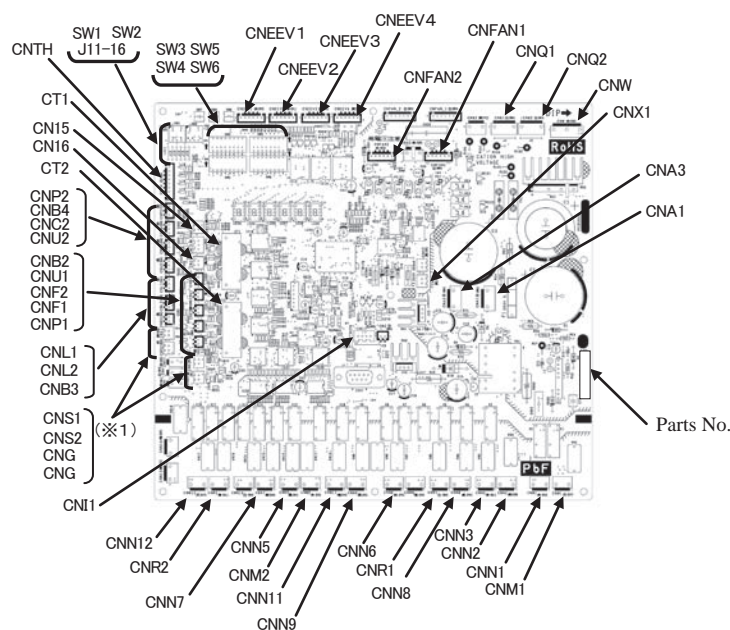

Fig.1 Parts arrangement

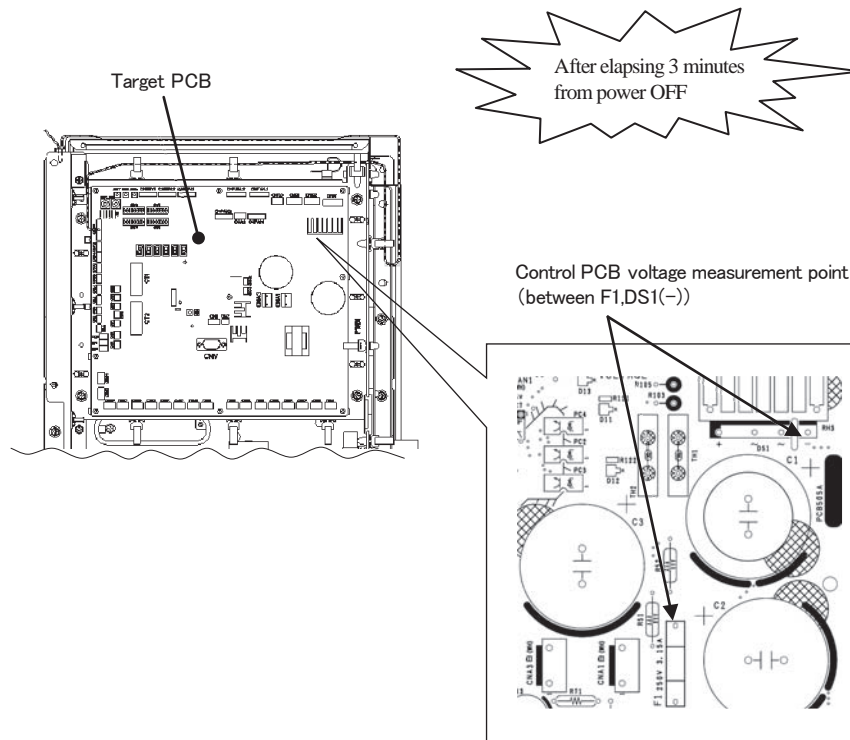

Fig.2 Voltage measurement points

※1 : Reuse the parts used before the PCB exchange.

※2 : Because spare PCB is commonized, by the model , extra connectors is implemented, compared with the former PCB.

When connecting the connectors after exchanging the PCB, Check the color and name of the connectors, please note the faulty connections.



2.5 Outdoor unit inverter PCB replacement procedure

PCB012D057B

Precautions for Safety

- Since the following precaution is the important contents for safety, be sure to observe them.

WARNING and CAUTION are described as follows:

-  **WARNING** Indicates an imminently hazardous situation which will result in death or serious injury if proper safety procedures and instructions are not adhered to.
-  **CAUTION** Indicates a potentially hazardous situation which may result in minor or moderate injury if proper safety procedures and instructions are not adhered to.

WARNING

- Securely replace PCB according to this procedure.
If the PCB is incorrectly replace, it will cause an electric shock or fire.
- Be sure to check that the power source for the outdoor unit is turned OFF before replacing the substrate.
The PCB replace under current-carrying will cause an electric shock of fire.
- After finishing the PCB replacement, check that wiring is correctly connected with the PCB before power distribution. If the PCB is incorrectly replaced, it will cause an electric shock or fire.

CAUTION

- Bundle the wiring so as not to tense because it will cause an electric shock.

Exchange the inverter PCB according to the following procedure.

1. Exchange the PCB **after elapsing 3 minutes from power OFF.**
(Be sure to measure voltage (DC) of two place ((A),(B)) and **check that the voltage is discharged sufficiently.**)
(Refer to Fig 3)
2. Disconnect the connectors from the PCB.
3. Exchange the PCB.
4. Match the setting switches (JSW10,11) with the former PCB.
5. Connect the connectors , wiring , and snubber capacitor .(Confirm the **connectors are not half inserted.**)

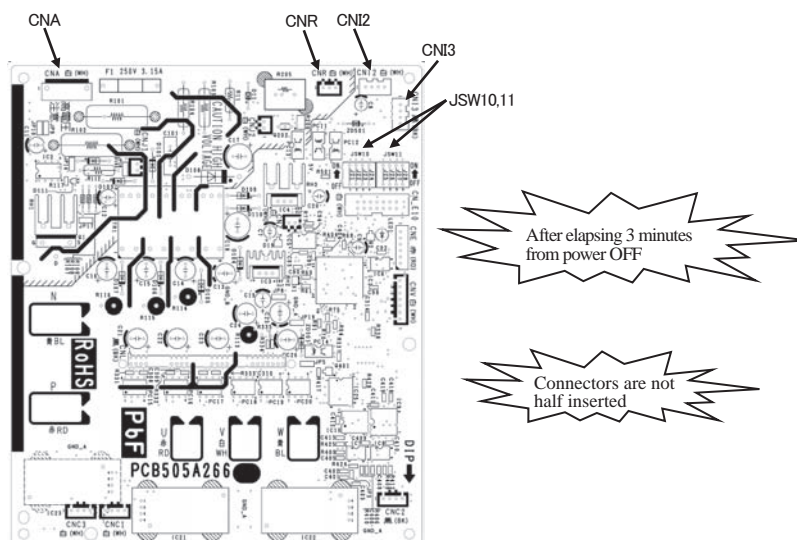

Fig.1 Parts arrangement

(A) Control PCB voltage measurement points

(B) Inverter PCB (INV1,2) voltage measurement points

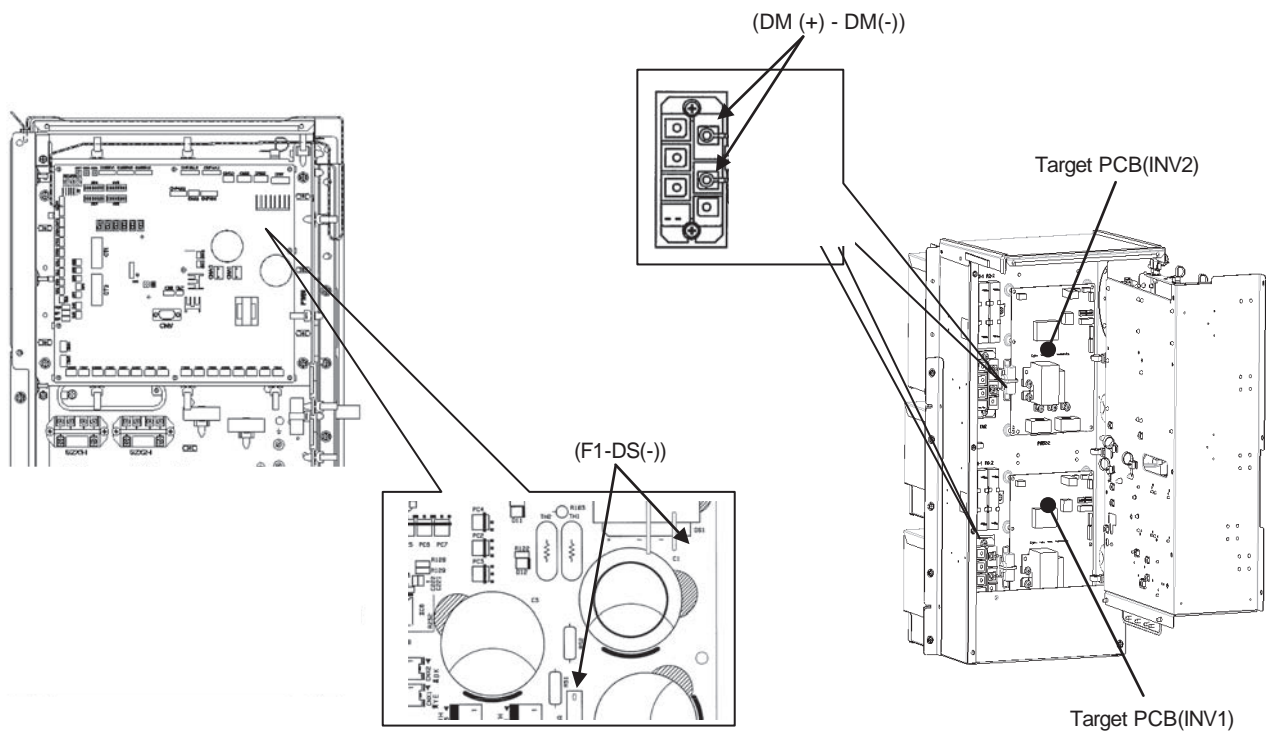
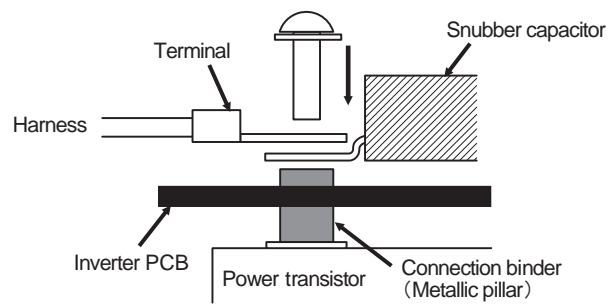

Fig.2 Voltage measurement points



Procedure on tightening harness (snubber capacitor) and power transistor with screw. A metallic connection binder is set in each hole of the inverter PCB of "P", "N", "U", "V", and "W" beforehand. Then tighten the harness (snubber capacitor) and the power transistor with the screw together.
 (Set the harness wires to be fixed to "U" and "W" with screws in respective holes after passing them through IC21 and 22.)
 (Connect snubber capacitor with "P" and "N".)

Fig.3 Installation method to power transistor

2.6 Outdoor unit transistor module replacement procedure

PCB012D043C

Precautions for Safety

- Since the following precaution is the important contents for safety, be sure to observe them.

WARNING and CAUTION are described as follows:



WARNING

Indicates an imminently hazardous situation which will result in death or serious injury if proper safety procedures and instructions are not adhered to.



CAUTION

Indicates a potentially hazardous situation which may result in minor or moderate injury if proper safety procedures and instructions are not adhered to.

⚠ WARNING

- Securely exchange the transistor module according to this procedure.
If the transistor module is incorrectly exchanged, it will cause an electric shock or fire.
- Be sure to check that the power source for the outdoor unit is turned OFF before exchanging the transistor module. The transistor module exchange under current-carrying will cause an electric shock.
- After finishing the transistor module exchange, check that wiring is correctly connected with the transistor module before power distribution. If the transistor module is incorrectly exchanged, it will cause an electric shock or fire.

⚠ CAUTION

- Band the wiring so as not to tense because it will cause an electric shock.

Exchange the transistor module according to the following procedure.

1. Exchange the transistor module **after elapsing 3 minutes from power OFF.**

(Be sure to measure voltage (DC) on both capacitor terminals (P, N of transistor module or connector terminals of fan motor power etc.) , **and check that the voltage is discharged sufficiently.**)

2. Disassemble the control box.
3. Disconnect with the wire (U, V, W, P, N) to the transistor module. (Refer to Fig.1 Parts arrangement view)
4. Pull up the inverter PCB from transistor module. Remove transistor module after removing the screw for transistor module.
5. Attach the transistor module. Coat the transistor module where its reverse-side all over with accessories silicone grease uniformly.
6. Set the inverter PCB with make sure of connect connector.
7. Connect with the wire (U, V, W, P, N) to the transistor module.
8. Assemble the control box as before.

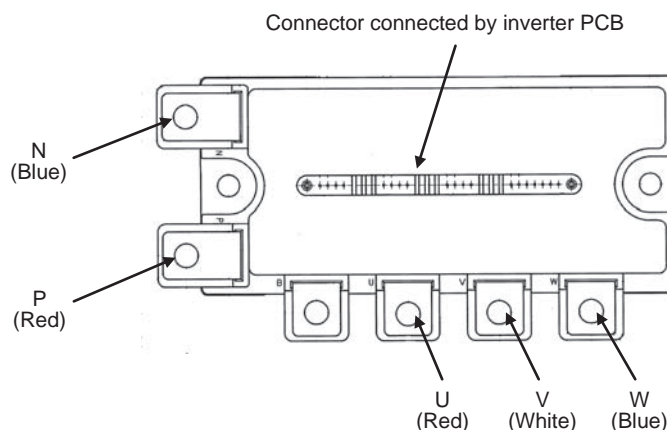

Fig.1 Parts arrangement view

2.7 Outdoor unit diode module replacement procedure

PCB012D009C

Precautions for Safety

- Since the following precaution is the important contents for safety, be sure to observe them.
WARNING and CAUTION are described as follows:

**WARNING**

Indicates an imminently hazardous situation which will result in death or serious injury if proper safety procedures and instructions are not adhered to.

**CAUTION**

Indicates a potentially hazardous situation which may result in minor or moderate injury if proper safety procedures and instructions are not adhered to.

WARNING

- Securely exchange the diode module according to this procedure.
If the diode module is incorrectly exchanged, it will cause an electric shock or fire.
- Be sure to check that the power source for the outdoor unit is turned OFF before exchanging the diode module. The diode module exchange under current-carrying will cause an electric shock.
- After finishing the diode module exchange, check that wiring is correctly connected with the diode module before power distribution. If the diode module is incorrectly exchanged, it will cause an electric shock or fire.

CAUTION

- Band the wiring so as not to tense because it will cause an electric shock.

It is recommended to exchange the diode module according to the following procedure.

- Start the replacing work **ten minutes after turning off the power.** (Be sure to measure the voltage (DC) between **the electrolytic capacitor terminals (connector terminals of fan motor power etc.) to check that the electrolytic capacitor have been discharged completely.**)
- Disassemble the control box.
- Disconnect with the wire (AC1, AC2, AC3, +, -) to the diode module. (See Fig. 1)
- Remove the diode module after removing the screw for diode module.
- Attach the diode module after applying uniformly silicone grease to the back surface of the diode module.
(Recommended diode module tightening torque: 2.4 ~ 2.8N·m)
- Connect the wire to the diode module (AC1, AC2, AC3, +, -). (See Fig.1)
(Recommended diode module tightening torque: 2.4 ~ 2.8N·m)
- Assemble the control box as before.

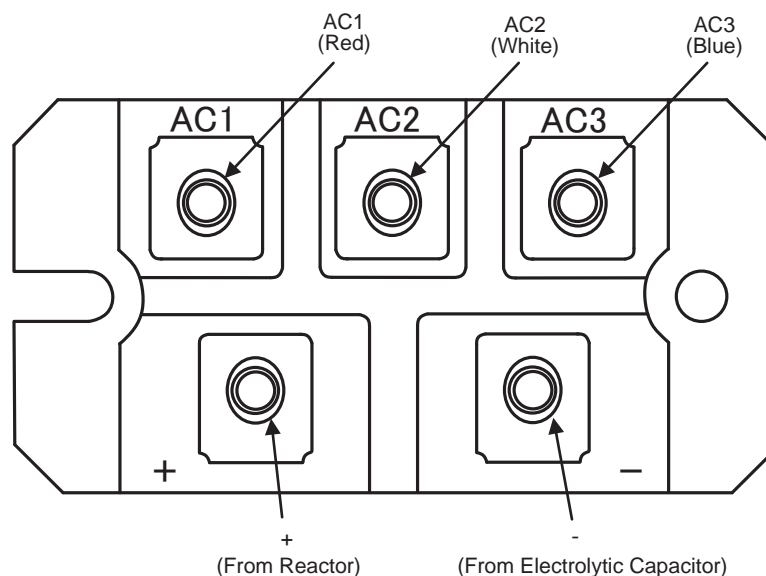

Fig.1 Parts arrangement view

● **Inspection method of faulty diode module**

When any error occurs on this unit as a result of ① trip of circuit breaker, ② inverter failure, ③ broken power transistor, ④ blown fuse, or other, it is necessary to suspect also for broken diode module.

Since the diode module is not installed on the PCB of this unit, the “repeated circuit breaker trip” or “de-energized” error will occur even after replacing the PCB.

In such occasion, troubleshoot as follows:

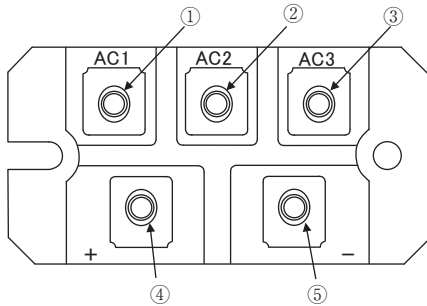

Fig. 1 View of diode module

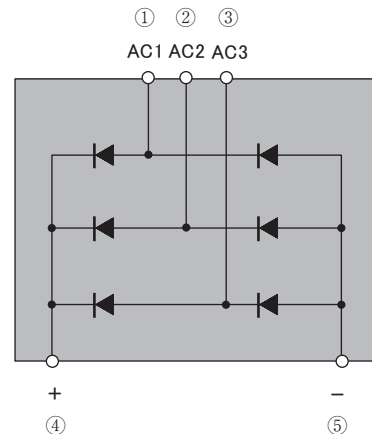

Fig. 2 Internal circuit of diode module

■ **Measure the resistance value at the points (No. 1 – 12) in Table 1 with a tester.**

Points ① - ⑤ correspond to the terminals shown in Fig. 1.

Table 1 Resistance value of diode module measured with tester (Value of sound product)

No.	Tester probe (+), red	Tester probe (-), black	Reading [Ω]	Remark
1	①	④	Few M	Upper arm, forward U direction
2	②	④	Few M	Upper arm, forward V direction
3	③	④	Few M	Upper arm, forward W direction
4	⑤	①	Few M	Lower arm, forward U direction
5	⑤	②	Few M	Lower arm, forward V direction
6	⑤	③	Few M	Lower arm, forward W direction
7	④	①	Several tens of M	Upper arm, reverse U direction
8	④	②	Several tens of M	Upper arm, reverse V direction
9	④	③	Several tens of M	Upper arm, reverse W direction
10	①	⑤	Several tens of M	Lower arm, reverse U direction
11	②	⑤	Several tens of M	Lower arm, reverse V direction
12	③	⑤	Several tens of M	Lower arm, reverse W direction

<Judgment>

(i) If it reads 0 to few $k\Omega$, the diode module could be broken.

(ii) Breakage is suspected also when it reads indefinite (∞) for No. 1 – 6 in the table.

*If it is judged to be i or ii, it is necessary to replace the diode module.

■ **Function of Dip switch for control (SW3, 4, 5)**

- SW3 (Function setting)

Switch		Function
SW3-1	ON	Inspection LED reset
	OFF	Normal
SW3-2	ON	Backup operation
	OFF	Normal
SW3-5	ON	Check operation start
	OFF	Normal
SW3-7	ON	Forced cooling/heating
	OFF	Normal

■ **Function of Jumper wire (J13, 15)
(With: Shorted / None: Opened)**

Jumper		Function	
J13	With	External input	Level input
	None	External input	Pulse input
J15	With	Defrost start temperature	Normal
	None	Defrost start temperature	Cold weather region

- SW5 (Function setting)

	ON/OFF	Function	
SW5-1	ON	Test run switch	test run
	OFF	Test run switch	Normal
SW5-2	ON	Test run operation mode	Cooling
	OFF	Test run operation mode	Heating
SW5-3	ON	Pump down switch	Pump down
	OFF	Pump down switch	Normal
SW5-5	ON	Superlink protocol : Previous SL	
	OFF	Superlink protocol : New SL	

- SW7,8,9 (Function setting)

Switch	Function		
SW7	Data erase/data write		
SW8	7-segment display No. UP	order of 1	
SW9	7-segment display No. UP	order of 10	

■ **Model selection with SW4-1 SW4-4**

0: OFF 1: ON

Model (HP)	224 (8)	280 (10)	335 (12)	400 (14)	450 (16)	475 (17)	500 (18)	560 (20)	615 (22)	670 (24)
SW4-1	0	1	0	0	1	1	0	1	0	0
SW4-2	0	0	1	0	0	1	1	1	0	1
SW4-3	0	0	0	1	1	0	1	1	1	1
SW4-4	0	0	0	0	0	0	0	0	1	1

■ **Model selection with SW4-1 SW4-4, SW6-3
(High-COP combination) 0: OFF 1: ON**

Model (HP)	224 (8)	280 (10)	335 (12)
SW4-1	0	1	0
SW4-2	0	0	1
SW4-3	0	0	0
SW4-4	0	0	0
SW6-3	1	1	1

■ **Master/slave setting with SW4-7, SW4-8**

0: OFF 1: ON

Outdoor unit	SW4-7	SW4-8
Master unit	0 ★	0 ★
Slave unit 1	1	0
Slave unit 2	0	1

■ Function of Connection

(1) Control PCB input

Mark	Connector	Function
Tho-A	CNTH	Outdoor air thermistor
Tho-R1	CNTH	Heat exchanger thermistor 1 (Exit, Front)
Tho-R2	CNB2	Heat exchanger thermistor 2 (Exit, Rear)
Tho-R3	CNB3	Heat exchanger thermistor 3 (Inlet, Front)
Tho-R4	CNB4	Heat exchanger thermistor 4 (Inlet, Rear)
Tho-R5	CN15	Heat exchanger thermistor 5 (Exit, Front)
Tho-R6	CN16	Heat exchanger thermistor 6 (Inlet, Front)
Tho-D1	CNTH	Discharge pipe thermistor 1(CM1)
Tho-D2	CNC2	Discharge pipe thermistor 2(CM2)
Tho-C1	CNU1	Under-dome thermistor 1(CM1)
Tho-C2	CNU2	Under-dome thermistor 2(CM2)
Tho-P1	CNP1	Power transistor thermistor 1(CM1)
Tho-P2	CNP2	Power transistor thermistor 2(CM2)
Tho-S	CNTH	Suction pipe thermistor
Tho-SC	CNF1	Subcooling coil thermistor 1
Tho-H	CNF2	Subcooling coil thermistor 2
CT1		Current sensor (CM1)
CT2		Current sensor (CM2)
PSH	CNL1	High pressure sensor
PSL	CNL2	Low pressure sensor
63H1-1	CHQ1	High pressure switch (CM1)
63H1-2	CHQ2	High pressure switch (CM2)
	CNS1	External operation input
	CNS2	Demand input
	CNG1	Forced operation input cooling/heating
	CNG2	Silent mode input
Power source	CNW	Open phase detection 380-415V

(2) Control PCB output

Mark	Connector	Function
52X1	CNM1	Solenoid for CM1
52X2	CNM2	Solenoid for CM2
20S1	CNN1	4-way valve
20SL	CNN5	4-way valve
20S3	CNN12	4-way valve
SV6	CNN2	Solenoid valve (oil return CM1)
SV7	CNN3	Solenoid valve (oil return CM2)
SV1	CNN6	Solenoid valve (CM1:liquid bypass)
SV2	CNN7	Solenoid valve (CM2:liquid bypass)
FMC1,2	CNN8	Fan for IPM
SV11	CNN9	Solenoid valve (gas bypass)
CH1	CNR1	Crankcase heater (CM1)
CH2	CNR2	Crankcase heater (CM2)
52XR	CnH	Operation output
52XE	CnY	Error output
	CnZ1	Spare
	CnE	RAM Checker output
	CnV	For servicing (for rewriting soft ware)
LED1		Inspection (Red)
LED2		Inspection (Green)
LED3		For service (Green)
7 SEG 1		7-segment LED1 (function indication)
7 SEG 2		7-segment LED2 (data indication)
EEVH1	CNEEV1	EEVH1 for heating (Front)
EEVH2	CNEEV3	EEVH2 for heating (Rear)
EEVH3	CNEEV2	EEVH3 for heating (Front)
EEVSC	CNEEV4	EEV-SC for Subcooling coil
Power source	CNA1,3	Fan motor

(3) Control PCB input/output

Mark	Connector	Function
FM01	CNFAN1-1	DC 15 V output (Vcc)
	-2	Reverse turn detection output (REV)
	-3	Speed command output (Vsp)
	-4	RPM monitor input (FG)
	-5	Over-current error input (OverC)
	-6	GND
FM02	CNFAN2-1	DC 15 V output (Vcc)
	-2	Reverse turn detection output (REV)
	-3	Speed command output (Vsp)
	-4	RPM monitor input (FG)
	-5	Over-current error input (OverC)
	-6	GND
	CnI1	Inverter protocol
	CnX1	Superlink protocol
	CnX2	Spare for Superlink protocol

Models FDC400KXZRE1, 450KXZRE1

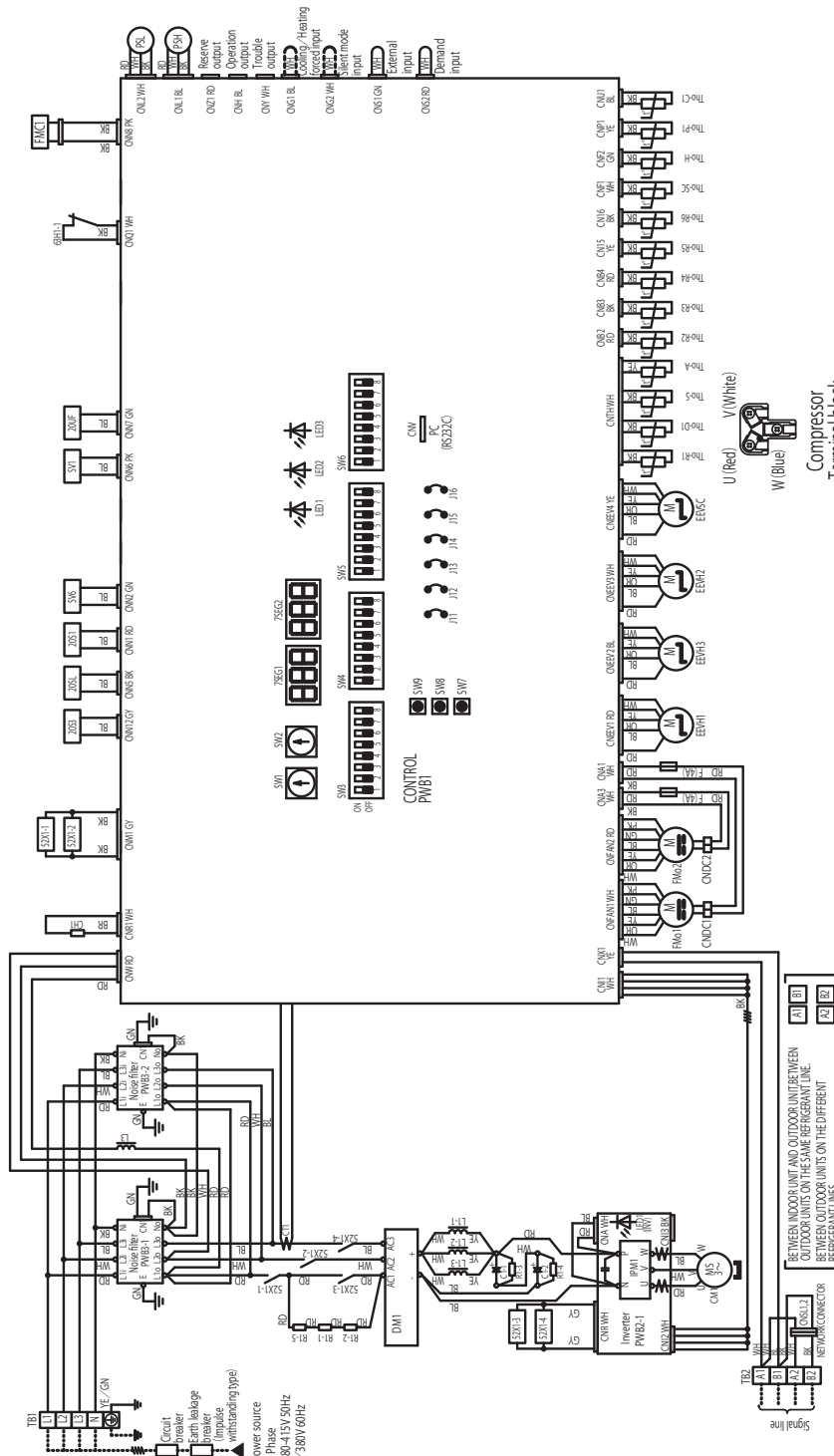

Color mark

Mark	Color
KK	Black
BL	Blue
BR	Brown
CN	Green
GY	Gray
OR	Orange
RD	Red
WH	White
YE	Yellow
PK	Pink
YE/GN	Yellow/Green

Terminal block

Mark	Parts name
Tho-A	External air thermostat
Tho-C1	Under-dome thermostat
Tho-D1	Discharge pipe thermostat
Tho-H	Sub-cooling coil thermostat Z
Tho-P1	Power transistor thermostat
Tho-R1	Heat exchanger thermostat (exhaust)
Tho-R2	Heat exchanger thermostat (inlet)
Tho-R4	Heat exchanger thermostat (inlet)
Tho-R5	Heat exchanger thermostat (exhaust)
Tho-R6	Heat exchanger thermostat (inlet)
Tho-SC	Suction pipe thermostat
Tho-5	Sub-cooling coil thermostat 1
Z0S1	4-way valve
Z0S3	4-way valve
Z0UF	Capacity control
63H-1 ~ 14	Solenoid for CM1
63H-1	High pressure switch (for protection)
75EG1	7-segment LED (function indication)
75EG2	7-segment LED (data indication)

Mark	Parts name
SW3-8	Spare
SW4-1 ~ 4	Model setting
SW4-5	Spare
SW4-6	Spare
SW4-7	Address setting switch (master-slave)
SW4-8	Address setting switch (master-slave)
SW5-1	ON1 Trial operation
SW5-2	ON1 Trial operation mode / cooling
SW5-3	ON1 Trial operation mode / heating
SW5-4	ON1 Pump down operation
SW5-5	ON1 Regular operation
SW5-6	Spare
SW5-7	ON1 Superlink communication
SW5-8	ON1 Superlink communication
SW6-1 ~ 4	Spare
SW7	Data clear / insert
SW8	7-segment indicate units place
SW9	7-segment LED (function indication)
PIB-1, 2	Terminal block

Mark	Parts name
L-1 ~ 3	D/C reactor
L3	D/C reactor
PSL	High pressure sensor
PSL	Low pressure sensor
PM1 ~ 3	Printed wiring board (PCB)
PI-1 ~ 15	Right current suppression resistor
SV1	Diode module
SV6	Expansion valve (oil bypass)
SV1	Solenoid valve (oil separator CM1)
SV2	Solenoid valve (oil separator CM2)
SV2	Address setting SW outdoor unit (No. 1, digit)
SV2	Address setting SW outdoor unit (No. 2, digit)
SV2-1	ON Auto backup operation
SV2-2	OFF Regular operation
SV2-3	ON Regular operation
SV2-4	Spare
SV2-5	ON Check operation
SV2-6	OFF Regular operation
SV2-7	ON Regular operation
SV2-8	Spare
SV2-9	ON Forced cooling / heating
SV2-10	OFF Regular operation

Meaning of marks

Mark	Parts name
CH1	Crankcase heater
CM1	Compressor motor
CMA-2	Connector
C1	Current sensor
C1-1, 2	Electrolytic capacitor
DM1	Diode module
EEV(H)_2,3	Expansion valve for heating
EEV(SC)	Expansion valve for SC
F	Fuse
FAN-C1	Fan for IPM
FAN-C2	Blower motor
IPM	Intelligent power module
J11, 1, 2	Set up model (volt)
J13	External input select level / pulse
J14	Defrost recover temp
J15	Heat recovery temp
J16	Heat recovery unit
LED1 (INV)	Inspection (Red)
LED1 (NW)	Normal (Yellow-Flashing)
LED2	Normal (Green)
LED3	Service (green for service)

PCB004Z090

Models FDC475KXZRE1, 500KXZRE1, 560KXZRE1
FDC615KXZRE1, 670KXZRE1

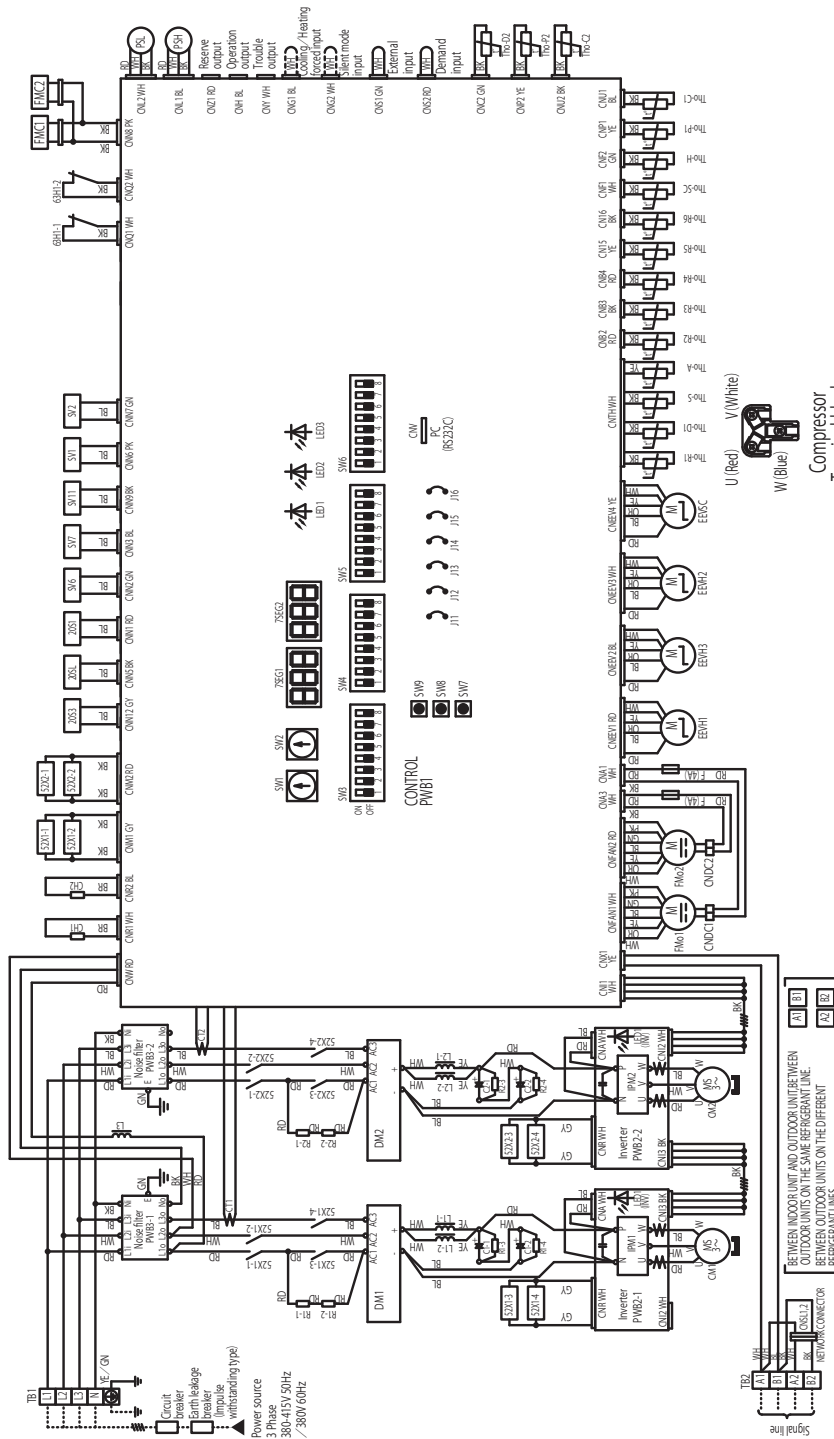

Color mark

Mark	Color
BK	Black
BL	Blue
BR	Brown
GN	Green
GY	Gray
OR	Orange
RD	Red
WH	White
YE	Yellow
PK	Pink
YE/GN	Yellow/Green

Mark	Parts name
TB1-2	Terminal block
Tho-A	External air thermostat
Tho-C1,2	Under-dome thermostat
Tho-D1,2	Discharge pipe thermostat
Tho-H	Sub-cooling coil thermostat 1
Tho-P1,2	Power transistor thermostat
Tho-R1	Heat exchanger thermostat (exhaust)
Tho-R2	Heat exchanger thermostat (inlet)
Tho-R3	Heat exchanger thermostat (inlet)
Tho-R4	Heat exchanger thermostat (inlet)
Tho-R5	Heat exchanger thermostat (exhaust)
Tho-R6	Heat exchanger thermostat (inlet)
Tho-S	Sub-cooling coil thermostat (inlet)
Z0S1	Sub-cooling coil thermostat 1
Z0S2	4-way valve
Z0S3	4-way valve
Z0S4	4-way valve
Z0S5	4-way valve
Z0S6	4-way valve
Z0S7	4-way valve
Z0S8	4-way valve
Z0S9	4-way valve
Z0S10	4-way valve
Z0S11	4-way valve
Z0S12	4-way valve
Z0S13	4-way valve
Z0S14	4-way valve
Z0S15	4-way valve
Z0S16	4-way valve
Z0S17	4-way valve
Z0S18	4-way valve
Z0S19	4-way valve
Z0S20	4-way valve
Z0S21	4-way valve
Z0S22	4-way valve
Z0S23	4-way valve
Z0S24	4-way valve
Z0S25	4-way valve
Z0S26	4-way valve
Z0S27	4-way valve
Z0S28	4-way valve
Z0S29	4-way valve
Z0S30	4-way valve
Z0S31	4-way valve
Z0S32	4-way valve
Z0S33	4-way valve
Z0S34	4-way valve
Z0S35	4-way valve
Z0S36	4-way valve
Z0S37	4-way valve
Z0S38	4-way valve
Z0S39	4-way valve
Z0S40	4-way valve
Z0S41	4-way valve
Z0S42	4-way valve
Z0S43	4-way valve
Z0S44	4-way valve
Z0S45	4-way valve
Z0S46	4-way valve
Z0S47	4-way valve
Z0S48	4-way valve
Z0S49	4-way valve
Z0S50	4-way valve
Z0S51	4-way valve
Z0S52	4-way valve
Z0S53	4-way valve
Z0S54	4-way valve
Z0S55	4-way valve
Z0S56	4-way valve
Z0S57	4-way valve
Z0S58	4-way valve
Z0S59	4-way valve
Z0S60	4-way valve
Z0S61	4-way valve
Z0S62	4-way valve
Z0S63	4-way valve
Z0S64	4-way valve
Z0S65	4-way valve
Z0S66	4-way valve
Z0S67	4-way valve
Z0S68	4-way valve
Z0S69	4-way valve
Z0S70	4-way valve
Z0S71	4-way valve
Z0S72	4-way valve
Z0S73	4-way valve
Z0S74	4-way valve
Z0S75	4-way valve
Z0S76	4-way valve
Z0S77	4-way valve
Z0S78	4-way valve
Z0S79	4-way valve
Z0S80	4-way valve
Z0S81	4-way valve
Z0S82	4-way valve
Z0S83	4-way valve
Z0S84	4-way valve
Z0S85	4-way valve
Z0S86	4-way valve
Z0S87	4-way valve
Z0S88	4-way valve
Z0S89	4-way valve
Z0S90	4-way valve
Z0S91	4-way valve
Z0S92	4-way valve
Z0S93	4-way valve
Z0S94	4-way valve
Z0S95	4-way valve
Z0S96	4-way valve
Z0S97	4-way valve
Z0S98	4-way valve
Z0S99	4-way valve
Z0S100	4-way valve

Mark	Parts name
SW3-7	ON: Forced cooling/heating
SW3-8	OFF: Regular operation
SW4-1	Spa
SW4-2	Spa
SW4-3	Spa
SW4-4	Spa
SW4-5	Spa
SW4-6	Spa
SW4-7	Spa
SW4-8	Spa
SW4-9	Spa
SW4-10	Spa
SW4-11	Spa
SW4-12	Spa
SW4-13	Spa
SW4-14	Spa
SW4-15	Spa
SW4-16	Spa
SW4-17	Spa
SW4-18	Spa
SW4-19	Spa
SW4-20	Spa
SW4-21	Spa
SW4-22	Spa
SW4-23	Spa
SW4-24	Spa
SW4-25	Spa
SW4-26	Spa
SW4-27	Spa
SW4-28	Spa
SW4-29	Spa
SW4-30	Spa
SW4-31	Spa
SW4-32	Spa
SW4-33	Spa
SW4-34	Spa
SW4-35	Spa
SW4-36	Spa
SW4-37	Spa
SW4-38	Spa
SW4-39	Spa
SW4-40	Spa
SW4-41	Spa
SW4-42	Spa
SW4-43	Spa
SW4-44	Spa
SW4-45	Spa
SW4-46	Spa
SW4-47	Spa
SW4-48	Spa
SW4-49	Spa
SW4-50	Spa
SW4-51	Spa
SW4-52	Spa
SW4-53	Spa
SW4-54	Spa
SW4-55	Spa
SW4-56	Spa
SW4-57	Spa
SW4-58	Spa
SW4-59	Spa
SW4-60	Spa
SW4-61	Spa
SW4-62	Spa
SW4-63	Spa
SW4-64	Spa
SW4-65	Spa
SW4-66	Spa
SW4-67	Spa
SW4-68	Spa
SW4-69	Spa
SW4-70	Spa
SW4-71	Spa
SW4-72	Spa
SW4-73	Spa
SW4-74	Spa
SW4-75	Spa
SW4-76	Spa
SW4-77	Spa
SW4-78	Spa
SW4-79	Spa
SW4-80	Spa
SW4-81	Spa
SW4-82	Spa
SW4-83	Spa
SW4-84	Spa
SW4-85	Spa
SW4-86	Spa
SW4-87	Spa
SW4-88	Spa
SW4-89	Spa
SW4-90	Spa
SW4-91	Spa
SW4-92	Spa
SW4-93	Spa
SW4-94	Spa
SW4-95	Spa
SW4-96	Spa
SW4-97	Spa
SW4-98	Spa
SW4-99	Spa
SW4-100	Spa

Mark	Parts name
L3	D.C reactor
PSH	High pressure sensor
PSL	Low pressure sensor
PMV1-3	Printed wiring board (PCB)
RA1-2,4	Right current suppression resistor
SV1	Solenoid valve (CM2 bypass)
SV2	Solenoid valve (CM2 bypass)
SV3	Solenoid valve (oil separator (CM2))
SV4	Solenoid valve (oil separator (CM2))
SV5	Solenoid valve (oil separator (CM2))
SV6	Solenoid valve (oil separator (CM2))
SV7	Solenoid valve (oil separator (CM2))
SV8	Solenoid valve (oil separator (CM2))
SV9	Solenoid valve (oil separator (CM2))
SV10	Solenoid valve (oil separator (CM2))
SV11	Solenoid valve (oil separator (CM2))
SV12	Solenoid valve (oil separator (CM2))
SV13	Solenoid valve (oil separator (CM2))
SV14	Solenoid valve (oil separator (CM2))
SV15	Solenoid valve (oil separator (CM2))
SV16	Solenoid valve (oil separator (CM2))
SV17	Solenoid valve (oil separator (CM2))
SV18	Solenoid valve (oil separator (CM2))
SV19	Solenoid valve (oil separator (CM2))
SV20	Solenoid valve (oil separator (CM2))
SV21	Solenoid valve (oil separator (CM2))
SV22	Solenoid valve (oil separator (CM2))
SV23	Solenoid valve (oil separator (CM2))
SV24	Solenoid valve (oil separator (CM2))
SV25	Solenoid valve (oil separator (CM2))
SV26	Solenoid valve (oil separator (CM2))
SV27	Solenoid valve (oil separator (CM2))
SV28	Solenoid valve (oil separator (CM2))
SV29	Solenoid valve (oil separator (CM2))
SV30	Solenoid valve (oil separator (CM2))
SV31	Solenoid valve (oil separator (CM2))
SV32	Solenoid valve (oil separator (CM2))
SV33	Solenoid valve (oil separator (CM2))
SV34	Solenoid valve (oil separator (CM2))
SV35	Solenoid valve (oil separator (CM2))
SV36	Solenoid valve (oil separator (CM2))
SV37	Solenoid valve (oil separator (CM2))
SV38	Solenoid valve (oil separator (CM2))
SV39	Solenoid valve (oil separator (CM2))
SV40	Solenoid valve (oil separator (CM2))
SV41	Solenoid valve (oil separator (CM2))
SV42	Solenoid valve (oil separator (CM2))
SV43	Solenoid valve (oil separator (CM2))
SV44	Solenoid valve (oil separator (CM2))
SV45	Solenoid valve (oil separator (CM2))
SV46	Solenoid valve (oil separator (CM2))
SV47	Solenoid valve (oil separator (CM2))
SV48	Solenoid valve (oil separator (CM2))
SV49	Solenoid valve (oil separator (CM2))
SV50	Solenoid valve (oil separator (CM2))
SV51	Solenoid valve (oil separator (CM2))
SV52	Solenoid valve (oil separator (CM2))
SV53	Solenoid valve (oil separator (CM2))
SV54	Solenoid valve (oil separator (CM2))
SV55	Solenoid valve (oil separator (CM2))
SV56	Solenoid valve (oil separator (CM2))
SV57	Solenoid valve (oil separator (CM2))
SV58	Solenoid valve (oil separator (CM2))
SV59	Solenoid valve (oil separator (CM2))
SV60	Solenoid valve (oil separator (CM2))
SV61	Solenoid valve (oil separator (CM2))
SV62	Solenoid valve (oil separator (CM2))
SV63	Solenoid valve (oil separator (CM2))
SV64	Solenoid valve (oil separator (CM2))
SV65	Solenoid valve (oil separator (CM2))
SV66	Solenoid valve (oil separator (CM2))
SV67	Solenoid valve (oil separator (CM2))
SV68	Solenoid valve (oil separator (CM2))
SV69	Solenoid valve (oil separator (CM2))
SV70	Solenoid valve (oil separator (CM2))
SV71	Solenoid valve (oil separator (CM2))
SV72	Solenoid valve (oil separator (CM2))
SV73	Solenoid valve (oil separator (CM2))
SV74	Solenoid valve (oil separator (CM2))
SV75	Solenoid valve (oil separator (CM2))
SV76	Solenoid valve (oil separator (CM2))
SV77	Solenoid valve (oil separator (CM2))
SV78	Solenoid valve (oil separator (CM2))
SV79	Solenoid valve (oil separator (CM2))
SV80	Solenoid valve (oil separator (CM2))
SV81	Solenoid valve (oil separator (CM2))
SV82	Solenoid valve (oil separator (CM2))
SV83	Solenoid valve (oil separator (CM2))
SV84	Solenoid valve (oil separator (CM2))
SV85	Solenoid valve (oil separator (CM2))
SV86	Solenoid valve (oil separator (CM2))
SV87	Solenoid valve (oil separator (CM2))
SV88	Solenoid valve (oil separator (CM2))
SV89	Solenoid valve (oil separator (CM2))
SV90	Solenoid valve (oil separator (CM2))
SV91	Solenoid valve (oil separator (CM2))
SV92	Solenoid valve (oil separator (CM2))
SV93	Solenoid valve (oil separator (CM2))
SV94	Solenoid valve (oil separator (CM2))
SV95	Solenoid valve (oil separator (CM2))
SV96	Solenoid valve (oil separator (CM2))
SV97	Solenoid valve (oil separator (CM2))
SV98	Solenoid valve (oil separator (CM2))
SV99	Solenoid valve (oil separator (CM2))
SV100	Solenoid valve (oil separator (CM2))

Mark	Parts name
CHI-2	Crankcase heater
CM1,2	Compressor motor
CNA-2	Connector
CT1,CT2	Current sensor
CT1,CT2,3	Electromagnetic capacitor
DM1,2	Diode module
EEVH1,2,3	Expansion valve for heating
EEVSC	Expansion valve for SC
F	Fuse
FM1,2	Fan for PM
PM	Blower motor
IPM	Intelligent power module
J1,1,2	Set up model (volt)
J1,3	External input select level / pulse
J1,4	Defrost recover temp
J1,5	Heat recovery unit
J1,6	Heat recovery unit
LED1	Inspection (Red)
LED1(NV)	Normal (Yellow) - Flashing
LED2	Normal (Green)
LED3	Service (green for service)
L1,1,2,1,2	D.C reactor

Mark	Parts name
SW3-7	ON: Forced cooling/heating
SW3-8	OFF: Regular operation
SW4-1	Spa
SW4-2	Spa
SW4-3	Spa
SW4-4	Spa
SW4-5	Spa
SW4-6	Spa
SW4-7	Spa
SW4-8	Spa
SW4-9	Spa
SW4-10	Spa
SW4-11	Spa
SW4-12	Spa
SW4-13	Spa
SW4-14	Spa
SW4-15	Spa
SW4-16	Spa
SW4-17	Spa
SW4-18	Spa
SW4-19	Spa
SW4-20	Spa
SW4-21	Spa
SW4-22	Spa
SW4-23	Spa
SW4-24	Spa
SW4-25	Spa
SW4-26	Spa
SW4-27	Spa
SW4-28	Spa
SW4-29	Spa
SW4-30	Spa
SW4-31	Spa
SW4-32	Spa
SW4-33	Spa
SW4-34	Spa
SW4-35	Spa
SW4-36	Spa
SW4-37	Spa
SW4-38	Spa
SW4-39	Spa
SW4-40	Spa
SW4-41	Spa
SW4-42	Spa
SW4-43	Spa
SW4-44	Spa
SW4-45	Spa
SW4-46	Spa
SW4-47	Spa
SW4-48	Spa
SW4-49	Spa
SW4-50	Spa
SW4-51	Spa
SW4-52	Spa
SW4-53	Spa
SW4-54	Spa
SW4-55	Spa
SW4-56	Spa
SW4-57	Spa
SW4-58	Spa
SW4-59	Spa
SW4-60	Spa
SW4-61	Spa
SW4-62	Spa
SW4-63	Spa
SW4-64	Spa
SW4-65	Spa
SW4-66	Spa
SW4-67	Spa
SW4-68	Spa
SW4-69	Spa
SW4-70	Spa
SW4-71	Spa
SW4-72	Spa
SW4-73	Spa
SW4-74	Spa
SW4-75	Spa
SW4-76	Spa
SW4-77	Spa
SW4-78	Spa
SW4-79	Spa
SW4-80	Spa
SW4-81	Spa
SW4-82	Spa
SW4-83	Spa
SW4-84	Spa
SW4-85	Spa
SW4-86	Spa
SW4-87	Spa
SW4-88	Spa
SW4-89	Spa
SW4-90	Spa
SW4-91	Spa
SW4-92	Spa
SW4-93	Spa
SW4-94	Spa
SW4-95	Spa
SW4-96	Spa
SW4-97	Spa
SW4-98	Spa
SW4-99	Spa
SW4-100	Spa

PCB004Z091

Models PFD1124-E, 1804-E, 2804-E

Notes 1. This diagram shows the circuit diagram when the branching control and relay kit (product with a branching controller attached) is connected.
 2. shows the current wiring.

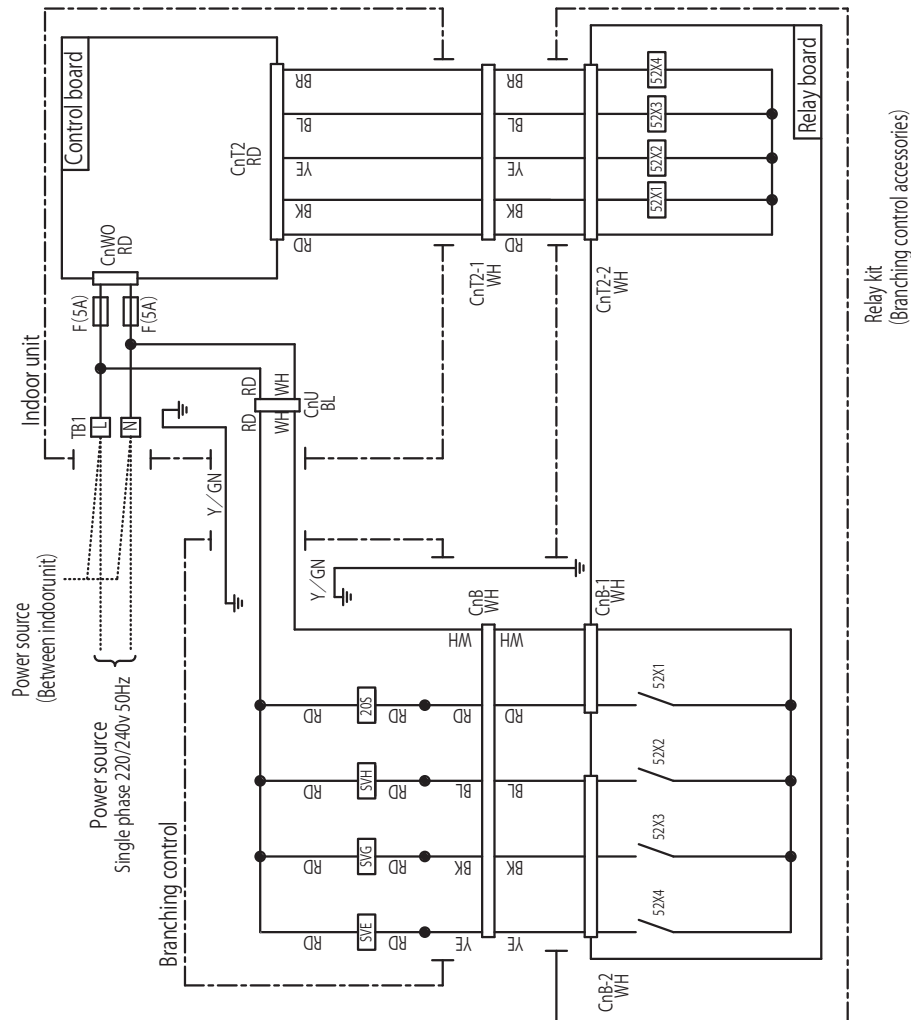

Mark	Meaning of marks	Parts name
CnB-U	Connector	
F	Fuse	
SVE	Solenoid valve for switching between cooling and heating	
SVG	Solenoid valve for oil return	
SVH	Solenoid valve for heating	
TB1	Terminal block (□ Mark)	
52X1	Relay for heating output	
52X2-4	Operating mode switching	
20S	Solenoid valve for switching 4-way	

Mark	Color
WH	White
RD	Red
BK	Black
YE	Yellow
BL	Blue
BR	Brown
Y/GN	Yellow/Green

Relay kit
(Branching control accessories)

PCB004Z116

Model PFD1124X4-E

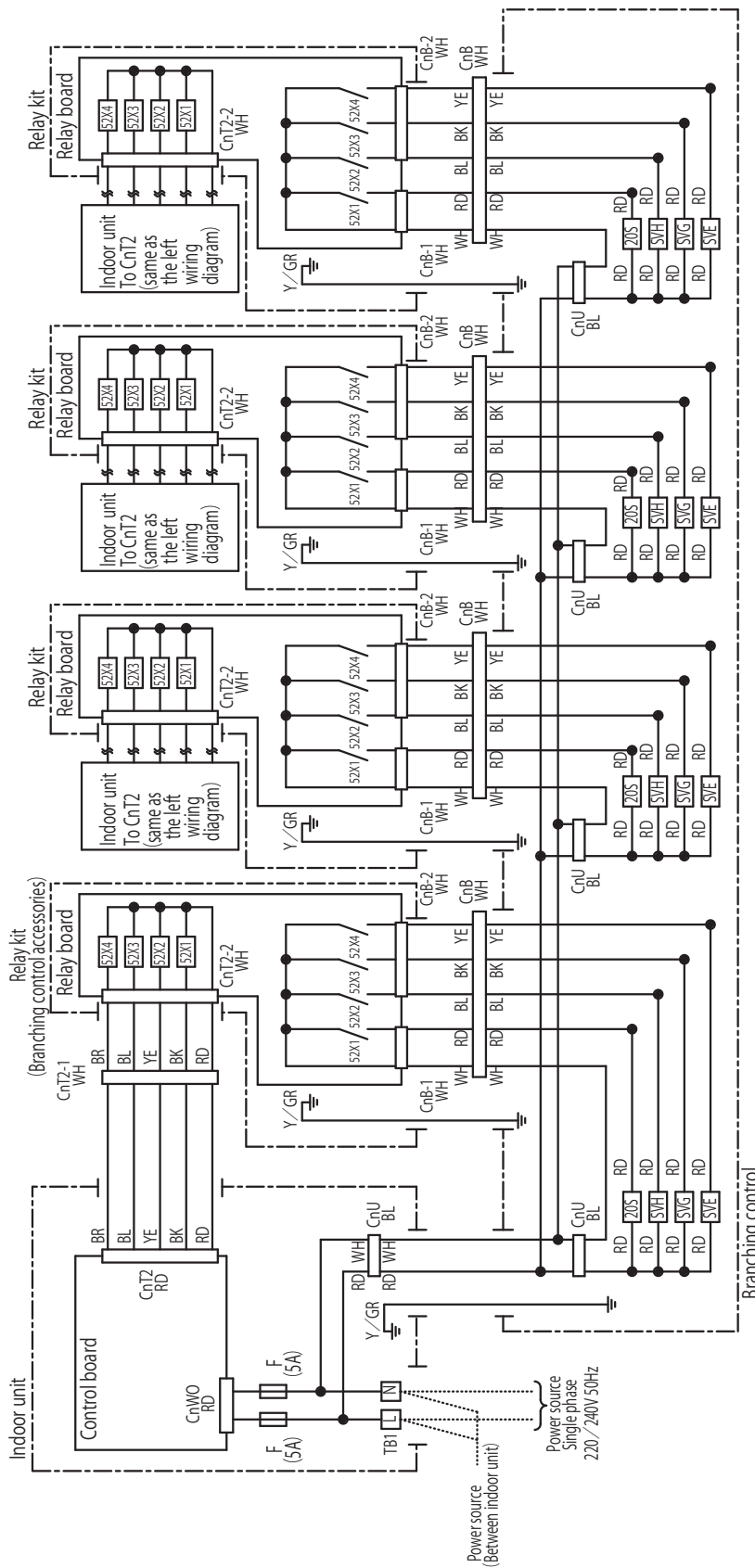

- Notes 1. This figure indicates the circuit diagram of connecting 4 branching controls and 4 relay kits (branching control accessories) respectively.
 2. shows the current wiring.
 3. Connect the signal line between a branching control and an indoor unit to the connector of the corresponding refrigerant system.

Meaning of marks	
Mark	Parts name
CnB - U	Connector
F	Fuse
SVE	Solenoid valve for switching between cooling and heating
SVG	Solenoid valve for oil return
SVH	Solenoid valve for heating
TBI	Terminal block (□ Mark)
52X1	Relay for heating output
52X2-4	Operating mode switching
ZOS	Solenoid valve for switching 4-way

Color marks	
Mark	Color
WH	White
RD	Red
BK	Black
YE	Yellow
BL	Blue
BR	Brown
Y/GR	Yellow / Green

PCB004Z147

4. PIPING SYSTEM

Models FDC224KXZRE1, 280KXZRE1, 335KXZRE1

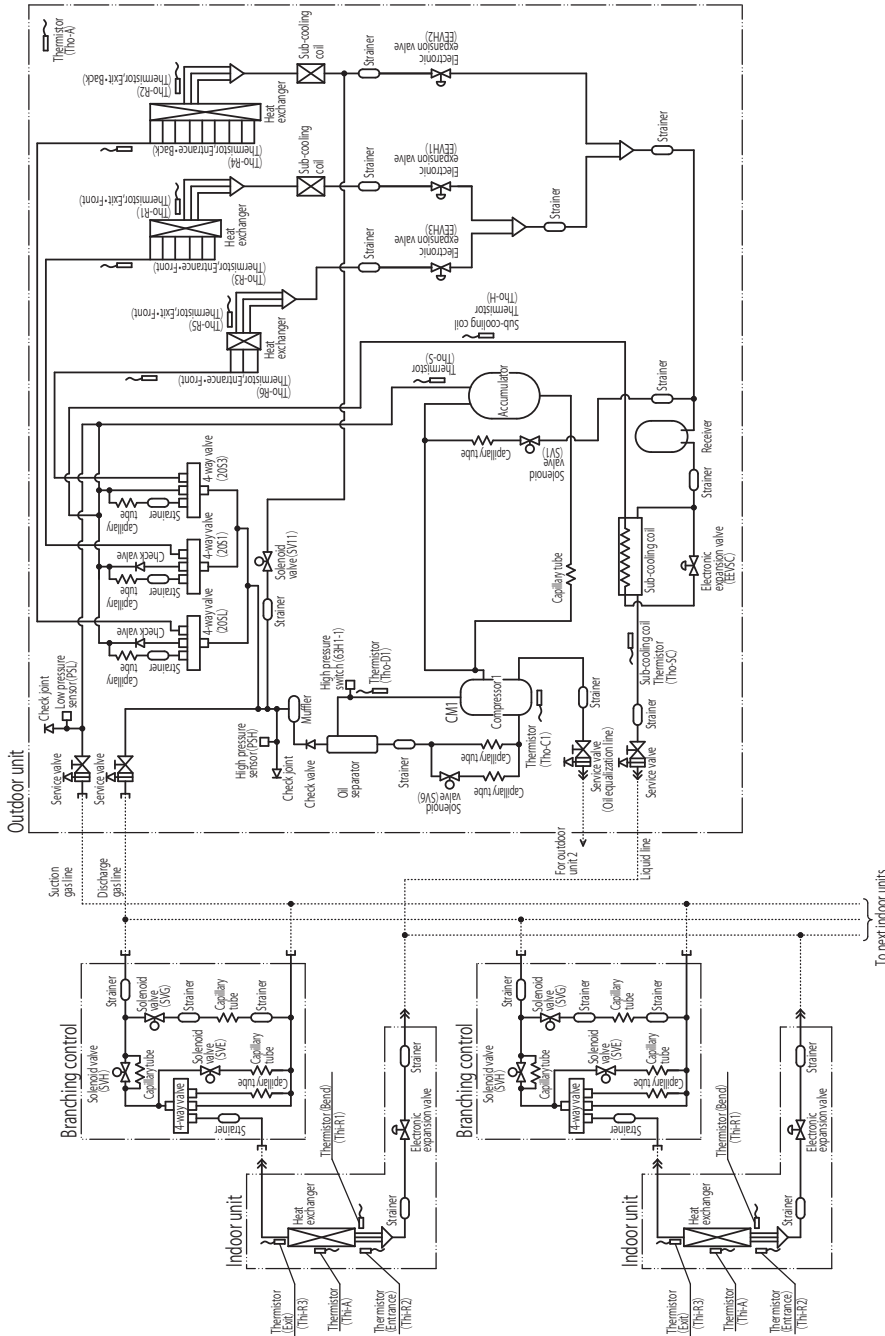

- Notes (1) Preset point of protective devices
 63HI-1 : Open 4.15MPa, Close 3.15MPa
 (For protection)
- (2) Function of thermistor
 PSH : For compressor control
 3.70 ON (MPa)
 PSL : ON 0.18MPa, OFF 0.20MPa
 (For compressor control)
 ON 0.134MPa, OFF 0.18MPa
 (For protection)
- Thi-R1, R2 : Heating operation : Indoor fan control.
 Cooling operation : Frost prevention control.
 Super heat control.
- Thi-R3 : For super heat control of cooling operation.
 Tho-D : For control of discharge pipe temperature.
 Tho-C : For control of temperature under the dome.
 Tho-S : For control of suction pipe temperature.
 Tho-R1,R2,R5 : For control of defrost operation.
 Tho-A : For control of defrost operation.
 Tho-R3, R4,R6 : Electronic expansion valve (EEVHI, 2) control of heating operation.
 Tho-SC : Electronic expansion valve (EEVSC) control of cooling operation.
 Tho-H : For super heat control of sub-cooling coil.

PCB004Z092

Models FDC400KXZRE1, 450KXZRE1

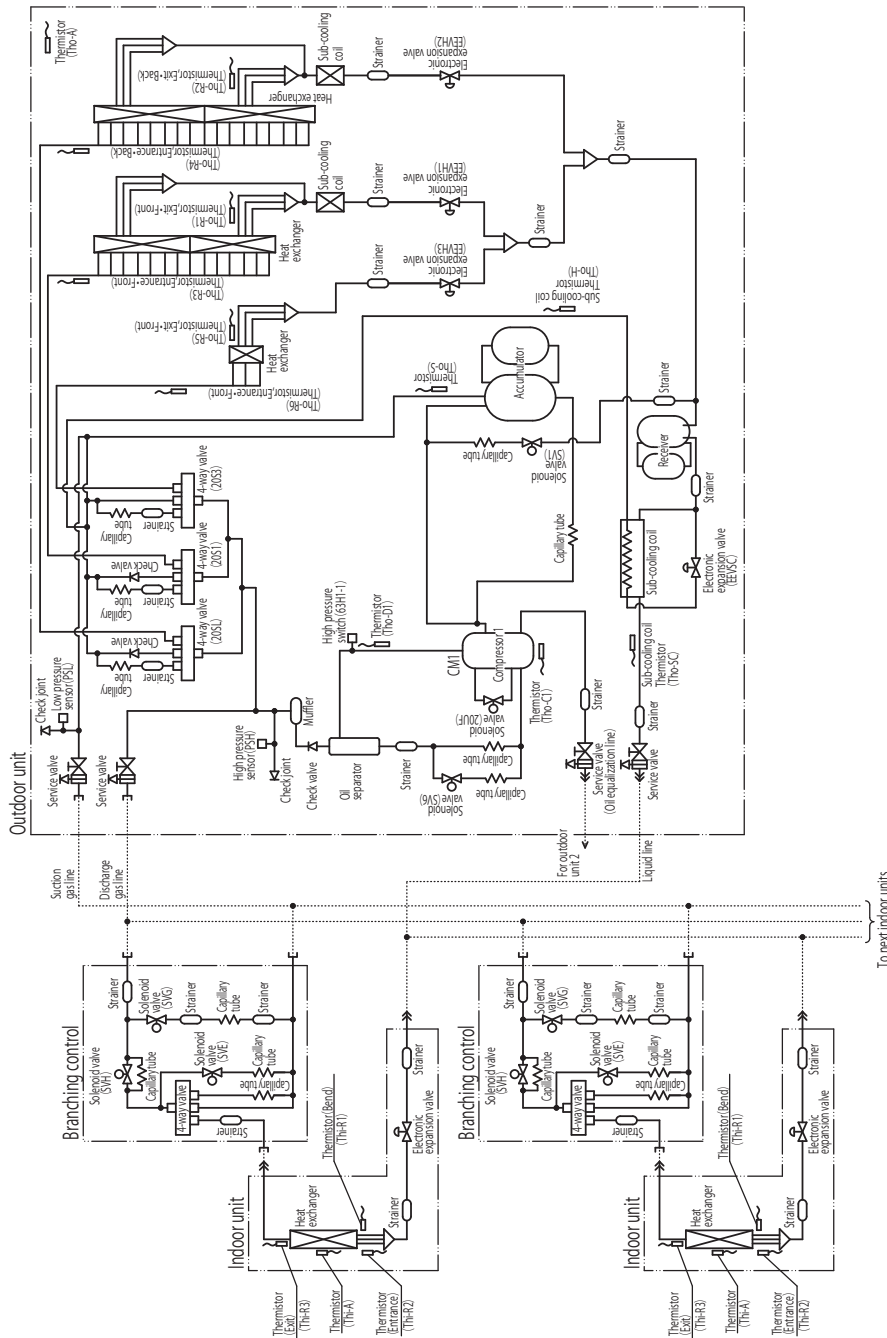

- Notes (1) Preset point of protective devices
 63H1-1 : Open 4.15MPa, Close 3.15MPa
 (For protection)
- (2) Function of thermistor
 PSH : For compressor control
 3.70 ON (MPa)
 PSL : ON 0.18MPa, OFF 0.20MPa
 (For compressor control)
 ON 0.134MPa, OFF 0.18MPa
 (For protection)

- Thi-R1, R2 : Heating operation : Indoor fan control.
 Cooling operation : Frost prevention control.
 Super heat control.
- Thi-R3 : For super heat control of cooling operation.
- Tho-D : For control of discharge pipe temperature.
- Tho-C : For control of temperature under the dome.
- Tho-S : For control of suction pipe temperature.
- Tho-R1,R2,R5 : For control of defrost operation.
- Tho-A : For control of defrost operation.
- Tho-R3, R4,R6 : Electronic expansion valve (EEVH1, 2) control of heating operation.
- Tho-SC : Electronic expansion valve (EEVSC) control of cooling operation.
- Tho-H : For super heat control of sub-cooling coil.

PCB004Z093

**Models FDC475KXZRE1, 500KXZRE1, 560KXZRE1
FDC615KXZRE1, 670KXZRE1**

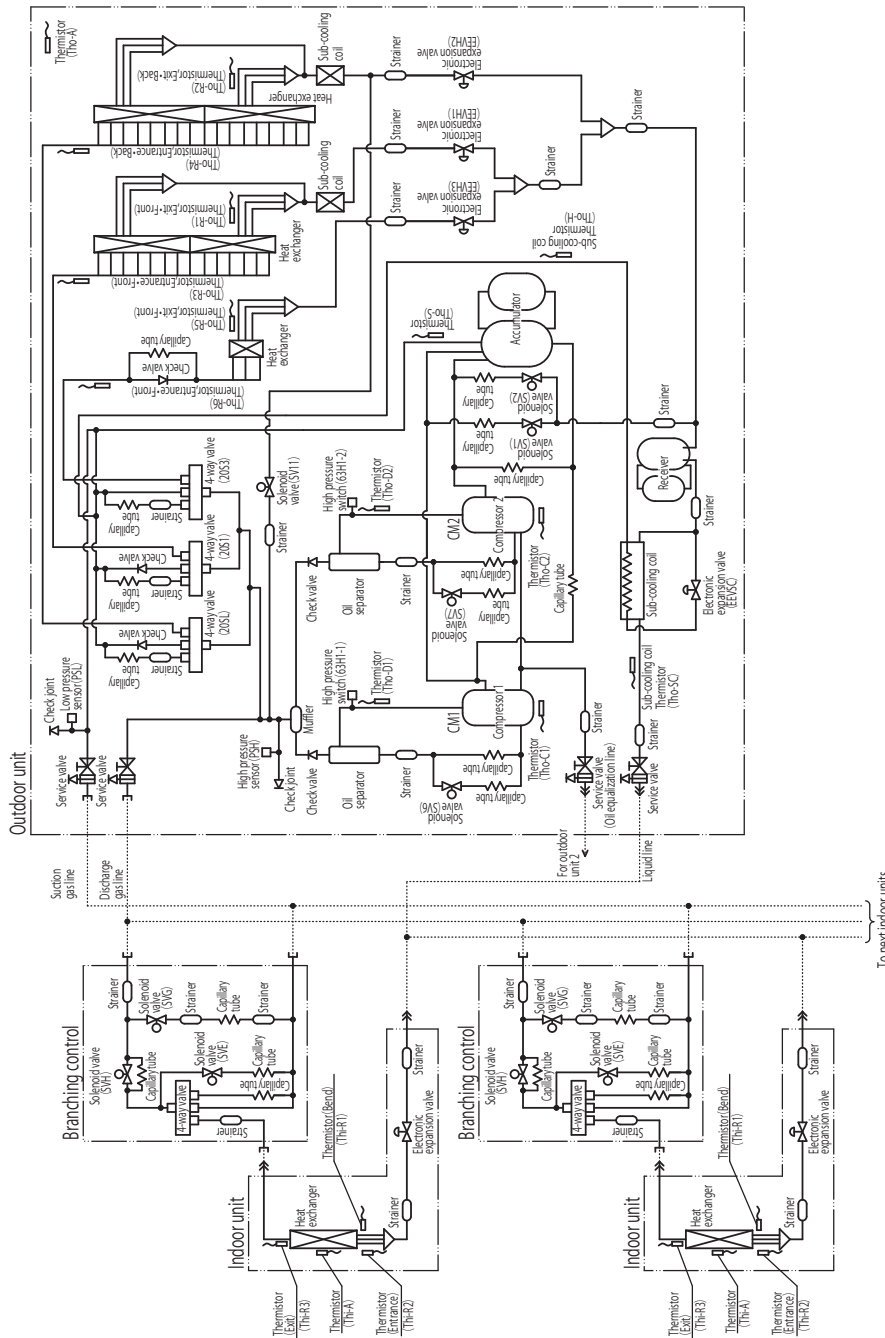

- Notes (1) Preset point of protective devices**
 63HI-1, 2 : Open 4.15MPa, Close 3.15MPa
 (For protection)
- (2) Function of thermistor**
PSH : For compressor control
 3.70 ON (MPa)
PSL : ON 0.18MPa, OFF 0.20MPa
 (For compressor control)
 ON 0.134MPa, OFF 0.18MPa
 (For protection)

- Thi-R1, R2** : Heating operation : Indoor fan control.
 Cooling operation : Frost prevention control.
 Super heat control.
- Thi-R3** : For super heat control of cooling operation.
- Tho-D1, D2** : For control of discharge pipe temperature.
- Tho-C1, C2** : For control of temperature under the dome.
- Tho-S** : For control of suction pipe temperature.
- Tho-R1, R2, R5** : For control of defrost operation.
- Tho-A** : For control of defrost operation.
- Tho-R3, R4, R6** : Electronic expansion valve (EEVH1, 2) control of heating operation.
- Tho-SC** : Electronic expansion valve (EEVSC) control of cooling operation.
- Tho-H** : For super heat control of sub-cooling coil.

PCB004Z094

5. APPLICATION DATA

5.1 Installation of outdoor unit

Designed for R410A refrigerant

PSC012D099A

Outdoor unit capacity
FDC224-1680

KXZ SERIES INSTALLATION MANUAL

- This installation manual deals with outdoor units and general installation specifications only. For indoor units, please refer to the respective installation manuals supplied with your units.
- Please read this manual carefully before you set to installation work and carry it out according to the instructions contained in this manual.

Precautions for safety

- Read these "Precautions for safety" carefully before starting installation work and do it in the proper way.
- Safety instructions listed here are grouped into **⚠ Warnings** and **⚡ Cautions**. If a non-compliant installation method is likely to result in a serious consequence such as death or major injury, the instruction is grouped into **⚠ Warnings** to emphasize its importance. However, a failure to observe a safety instruction listed under **⚡ Cautions** can also result in a serious consequence depending on the circumstances. Please observe all these instructions, because they include important points concerning safety.
- The meanings of "Marks" used here are as shown on the right: **⊘ Never do it under any circumstances.** **⚠ Always do it according to the instruction.**
- When you have completed installation work, perform a test run and make sure that the installation is working properly. Then, explain the customer how to operate and how to take care of the air-conditioner according to the user's manual. Please ask the customer to keep this installation manual together with the user's manual.
- This unit complies with EN61000-3-11.
- For outdoor unit, EN61000-3-2 and EN61000-3-12 are not applicable as consent by the utility company or notification to the utility company is given before usage.

⚠ WARNING

⚠

- Installation must be carried out by the qualified installer.
If you install the system by yourself, it may cause serious trouble such as water leaks, electric shocks, fire and personal injury, as a result of a system malfunction.
- Install the system in full accordance with the instruction manual.
Incorrect installation may cause bursts, personal injury, water leaks, electric shocks and fire.
- Use the original accessories and the specified components for installation.
If parts other than those prescribed by us are used, it may cause fall of the unit, water leaks, electric shocks, fire, refrigerant leak, substandard performance, control failure and personal injury.
- When installing in small rooms, take prevention measures not to exceed the density limit of refrigerant in the event of leakage accordance with ISO149.
Consult the expert about prevention measures. If the density of refrigerant exceeds the limit in the event of leakage, lack of oxygen can occur, which can cause serious accidents.
- Ventilate the working area well in the event of refrigerant leakage during installation.
If the refrigerant comes into contact with naked flames, poisonous gas is produced.
- After completed installation, check that no refrigerant leaks from the system.
If refrigerant leaks into the room and comes into contact with an oven or other hot surface, poisonous gas is produced.
- Hang up the unit at the specified points with ropes which can support the weight in lifting for portage. And to avoid jolting out of alignment, be sure to hang up the unit at 4-point support.
An improper manner of portage such as 3-point support can cause death or serious personal injury due to falling of the unit.
- Install the unit in a location with good support.
Unstable installation locations can cause the unit to fall and cause material damage and personal injury.
- Ensure the unit is stable when installed, so that it can withstand earthquakes and strong winds.
Unstable installation locations can cause the unit to fall and cause material damage and personal injury.
- The electrical installation must be carried out by the qualified electrician in accordance with "the norm for electrical work" and "national wiring regulation", and the system must be connected to the dedicated circuit.
Power source with insufficient capacity and incorrect function done by improper work can cause electric shocks and fire.
- Be sure to shut off the power before starting electrical work.
Failure to shut off the power can cause electric shocks, unit failure or incorrect function of equipment.
- Be sure to use the cables conformed to safety standard and cable ampacity for power distribution work.
Unconformable cables can cause electric leak, anomalous heat production or fire.
- Use the prescribed cables for electrical connection, tighten the cables securely in terminal block and relieve the cables correctly to prevent overloading the terminal blocks.
Loose connections or cable mountings can cause anomalous heat production or fire.
- Arrange the wiring in the control box so that it cannot be pushed up further into the box. Install the service panel correctly.
Incorrect installation may result in overheating and fire.
- In connecting the power cable, make sure that no anomalies such as dust deposits, socket clogging or wobble are found and insert the plug securely.
Accumulation of dust, clogging on the socket, or looseness of plugging can cause electric shocks and fire.
- Be sure not to reuse existing refrigerant pipes
Conventional refrigerant oil or chlorine contained in the conventional refrigerant which is remaining in the existing refrigerant pipes can cause deterioration of refrigerant oil of new unit. And 1.6 times higher pressure of R410A refrigerant than conventional one can cause burst of existing pipe, personal injury or serious accident.
- Do not perform brazing work in the airtight room
It can cause lack of oxygen.
- Use the prescribed pipes, flare nuts and tools for R410A.
Using existing parts (for R22 or R407C) can cause the unit failure and serious accidents due to burst of the refrigerant circuit.
- Tighten the flare nut by using double spanners and torque wrench according to prescribed method. Be sure not to tighten the flare nut too much.
Loose flare connection or damage on the flare part by tightening with excess torque can cause burst or refrigerant leaks which may result in lack of oxygen.
- Do not open the service valves for liquid line and gas line until completed refrigerant piping work, air tightness test and evacuation.
If the compressor is operated in state of opening service valves before completed connection of refrigerant piping work, you may incur frost bite or injury from an abrupt refrigerant outflow and air can be sucked into refrigerant circuit, which can cause burst or personal injury due to anomalously high pressure in the refrigerant.
- Do not put the drainage pipe directly into drainage channels where poisonous gases such as sulphide gas can occur.
Poisonous gases will flow into the room through drainage pipe and seriously affect the user's health and safety. It can also cause the corrosion of the indoor unit and resultant unit failure or refrigerant leak.
- Only use prescribed option parts. The installation must be carried out by the qualified installer.
If you install the system by yourself, it can cause serious trouble such as water leaks, electric shocks, fire.
- Do not perform any change of protective device itself or its setup condition
The forced operation by short-circuiting protective device of pressure switch and temperature control or the use of non specified component can cause fire or burst.
- Be sure to switch off the power source in the event of installation, inspection or servicing.
If the power source is not shut off, there is a risk of electric shocks, unit failure or personal injury due to the unexpected start of fan.
- Consult the dealer or an expert regarding removal of the unit.
Incorrect installation can cause water leaks, electric shocks or fire.
- Stop the compressor before closing valve and disconnecting refrigerant pipes in case of pump down operation.
If disconnecting refrigerant pipes in state of opening service valves before compressor stopping, you may incur frost bite or injury from an abrupt refrigerant outflow and air can be sucked, which can cause burst or personal injury due to anomalously high pressure in the refrigerant circuit.

⊘

- Ensure that no air enters in the refrigerant circuit when the unit is installed and removed.
If air enters in the refrigerant circuit, the pressure in the refrigerant circuit becomes too high, which can cause burst and personal injury.
- Do not run the unit with removed panels or protections
Touching rotating equipments, hot surfaces or high voltage parts can cause personal injury due to entrapment, burn or electric shocks.
- Be sure to fix up the service panels.
Incorrect fixing can cause electric shocks or fire due to intrusion of dust or water.
- Do not perform any repairs or modifications by yourself. Consult the dealer if the unit requires repair.
If you repair or modify the unit, it can cause water leaks, electric shocks or fire.

⚡ CAUTION

⚡

- Use the circuit breaker for all pole with correct capacity.
Using the incorrect circuit breaker, it can cause the unit malfunction and fire.
- Take care when carrying the unit by hand.
If the unit weighs more than 20kg, it must be carried by two or more persons. Do not carry by the plastic straps, always use the carry handle when carrying the unit by hand. Use gloves to minimize the risk of cuts by the aluminum fins.
- Dispose of any packing materials correctly.
Any remaining packing materials can cause personal injury as it contains nails and wood. And to avoid danger of suffocation, be sure to keep the plastic wrapper away from children and to dispose after tear it up.
- Pay attention not to damage the drain pan by weld spatter when welding work is done near the indoor unit.
If weld spatter entered into the indoor unit during welding work, it can cause pin-hole in drain pan and result in water leakage. To prevent such damage, keep the indoor unit in its packing or cover it.
- Be sure to insulate the refrigerant pipes so as not to condense the ambient air moisture on them.
Insufficient insulation can cause condensation, which can lead to moisture damage on the ceiling, floor, furniture and any other valuables.
- Be sure to perform air tightness test by pressurizing with nitrogen gas after completed refrigerant piping work.
If the density of refrigerant exceeds the limit in the event of refrigerant leakage in the small room, lack of oxygen can occur, which can cause serious accidents.
- Perform installation work properly according to this installation manual.
Improper installation can cause abnormal vibrations or increased noise generation.

⚡

- Carry out the electrical work for ground lead with care.
Do not connect the ground lead to the gas line, water line, lightning conductor or telephone line's ground lead. Incorrect grounding can cause unit faults such as electric shocks due to short-circuiting. Never connect the grounding wire to a gas pipe because if gas leaks, it could cause explosion or ignition.

⚡

- Earth leakage breaker must be installed
If the earth leakage breaker is not installed, it can cause fire or electric shocks.
- Do not use any materials other than a fuse with the correct rating in the location where fuses are to be used.
Connecting the circuit with copper wire or other metal thread can cause unit failure and fire.
- Do not install the unit near the location where leakage of combustible gases can occur.
If leaked gases accumulate around the unit, it can cause fire.
- Do not install the unit where corrosive gas (such as sulfuric acid gas etc.) or combustible gas (such as thinner and petroleum gases) can accumulate or collect, or where volatile combustible substances are handled.
Corrosive gas can cause corrosion of heat exchanger, breakage of plastic parts and etc. And combustible gas can cause fire.
- Secure a space for installation, inspection and maintenance specified in the manual.
Insufficient space can result in accident such as personal injury due to falling from the installation place.
- When the outdoor unit is installed on a roof or a high place, provide permanent ladders and handrails along the access route and fences and handrails around the outdoor unit.
If safety facilities are not provided, it can cause personal injury due to falling from the installation place.
- Do not install nor use the system close to the equipment that generates electromagnetic fields or high frequency harmonics
Equipment such as inverters, standby generators, medical high frequency equipments and telecommunication equipments can affect the system, and cause malfunctions and breakdowns. The system can also affect medical equipment and telecommunication equipment, and obstruct its function or cause jamming.
- Do not install the outdoor unit in a location where insects and small animals can inhabit.
Insects and small animals can enter the electric parts and cause damage or fire. Instruct the user to keep the surroundings clean.
- Do not use the base frame for outdoor unit which is corroded or damaged due to long periods of operation.
Using an old and damaged base frame can cause the unit falling down and cause personal injury.
- Do not install the unit in the locations listed below
 - Locations where carbon fiber, metal powder or any powder is floating.
 - Locations where any substances that can affect the unit such as sulphide gas, chloride gas, acid and alkaline can occur.
 - Vehicles and ships
 - Locations where cosmetic or special sprays are often used.
 - Locations with direct exposure of oil mist and steam such as kitchen and machine plant.
 - Locations where any machines which generate high frequency harmonics are used.
 - Locations with salty atmospheres such as coastlines
 - Locations with heavy snow (if installed, be sure to provide base frame and snow hood mentioned in the manual)
 - Locations where the unit is exposed to chimney smoke
 - Locations at high altitude (more than 1000m high)
 - Locations with ammoniac atmospheres
 - Locations where heat radiation from other heat source can affect the unit
 - Locations without good air circulation.
 - Locations with any obstacles which can prevent inlet and outlet air of the unit
 - Locations where short circuit of air can occur (in case of multiple units installation)
 - Locations where strong air blows against the air outlet of outdoor unit
It can cause remarkable decrease in performance, corrosion and damage of components, malfunction and fire.
- Do not install the outdoor unit in the locations listed below.
 - Locations where discharged hot air or operating sound of the outdoor unit can bother neighborhood.
 - Locations where outlet air of the outdoor unit blows directly to an animal or plants. The outlet air can affect adversely to the plant etc.
 - Locations where vibration can be amplified and transmitted due to insufficient strength of structure.
 - Locations where vibration and operation sound generated by the outdoor unit can affect seriously.
(on the wall or at the place near bed room)
 - Locations where an equipment affected by high harmonics is placed. (TV set or radio receiver is placed within 5m)
 - Locations where drainage cannot run off safely.
- Do not affect surrounding environment and cause a claim
- Do not use the unit for special purposes such as storing foods, cooling precision instruments and preservation of animals, plants or art. It can cause the damage of the items.
- Do not touch any buttons with wet hands
It can cause electric shocks
- Do not shut off the power source immediately after stopping the operation.
Wait at least 5 minutes, otherwise there is a risk of water leakage or breakdown.
- Do not control the system with main power switch.
It can cause fire or water leakage. In addition, the fan can start unexpectedly, which can cause personal injury.
- Do not touch any refrigerant pipes with your hands when the system is in operation.
During operation the refrigerant pipes become extremely hot or extremely cold depending the operating condition, and it can cause burn injury or frost injury.
- Do not operate the outdoor unit with any article placed on it.
You may incur property damage or personal injury from a fall of the article.
- Do not step onto the outdoor unit.
You may incur injury from a drop or fall.

⚡

- 147 -

Notabilia as a unit designed for R410A

- Do not use any refrigerant other than R410A. R410A will rise to pressure about 1.6 times higher than that of a conventional refrigerant.
- A cylinder containing R410A has a pink indication mark on the top.
- A unit designed for R410A has adopted a different size indoor unit operation valve charge port and a different size check joint provided in the unit to prevent the charging of a wrong refrigerant by mistake. The processed dimension of the flared part of a refrigerant pipe and a flare nut's parallel side measurement have also been altered to raise strength against pressure. Accordingly, you are required to arrange dedicated R410A tools listed in the table on the right before installing or servicing this unit.
- Do not use a charge cylinder. The use of a charge cylinder will cause the refrigerant composition to change, which results in performance degradation.
- In charging refrigerant, always take it out from a cylinder in the liquid phase.
- All indoor units must be models designed exclusively for R410A. Please check connectable indoor unit models in a catalog, etc. (A wrong indoor unit, if connected into the system, will impair proper system operation)

Dedicated R410A tools	
a)	Gauge manifold
b)	Charge hose
c)	Electronic scale for refrigerant charging
d)	Torque wrench
e)	Flare tool
f)	Protrusion control copper pipe gauge
g)	Vacuum pump adapter
h)	Gas leak detector

1. BEFORE BEGINNING INSTALLATION (Check that the models, power source specifications, piping, wiring are correct.)

CAUTION

- Please read this manual without fail before you set to installation work and carry it out according to this manual.
- For the installation of an indoor unit, please refer to the installation manual of an indoor unit.
- For piping work, optional distribution parts (branching pipe set, header set) are necessary. Please refer to our catalog, etc.
- Never fail to install an earth leakage breaker. (Please use one tolerable to harmonic components)
- Operating the unit with the outlet pipe thermistor, the inlet pipe thermistor, the pressure sensor, etc. removed can result in a compressor burnout. Avoid operation under such conditions in any circumstances.
- With this air-conditioning system, room temperature may rise, depending on installation conditions, while indoor units are stopped, because small quantity of refrigerant flows into the stopped indoor units if heating operation is conducted on the system.

ACCESSORY

Name	Quantity	Usage location	
Wiring 	2	In operating the unit in the silent mode or the forced cooling/heating mode, insert it to the outdoor unit board's CNG.	It is supplied with the unit. You can find it taped inside the control box.
Instruction manual	1	When the installation work is completed, give instructions to the customer and ask him/her to keep it.	Attached on the side panel below the operation valve.

COMBINATION PATTERNS

- The possible outdoor unit combinations and the number and the total capacity of indoor units that can be connected in a system are shown in the table below.
- Please always use indoor units designed exclusively for R410A. For connectable indoor unit model names, please check with our catalog, etc.
- It can be used in combination with the following indoor unit.

Indoor unit	Remote control	Connection OK/NO
FD○△△KXE6, KXE1	RC-E3(2 cores), RC-E4(2 cores), RC-E5 (2 cores), RC-EX1A (2 cores)	OK
FD○A△△KXE4R, KXE4BR, KXE5R	RC-E1R(3 cores)	NO
FD○A△△KXE4, KXE4(A), KXE4A	RC-E1(3 cores)	NO

Notabilia

The same outdoor unit is used whether it is used alone or in combination with another unit.

- Please note that an installation involving a combination other than those listed below is not operable.(For example, you cannot operate 560 and 670 in combination)

Outdoor unit		Indoor unit	
Capacity	Combination patterns	Number of connectable units (units)	Range of the total capacity of indoor units connected in a system ^{※1}
224	single	1 - 29	112 - 448
280	single	1 - 37	140 - 560
335	single	1 - 44	168 - 670
400	single	1 - 53	200 - 800
450	single	1 - 60	225 - 900
475	single	1 - 50	238 - 760
500	single	1 - 53	250 - 800
560	single	1 - 59	280 - 896
615	single	2 - 65	308 - 984
670	single	2 - 71	335 - 1072
735	combination (335+400)	2 - 78	368 - 1176
800	combination (400+400)	2 - 80	400 - 1280
850	combination (400+450)	2 - 80	425 - 1360
900	combination (450+450)	2 - 80	450 - 1440
950	combination (475+475)	2 - 80	475 - 1520
1000	combination (500+500)	2 - 80	500 - 1300
1060	combination (500+560)	2 - 80	530 - 1378
1120	combination (560+560)	2 - 80	560 - 1456
1200	combination (400+400+400)	3 - 80	600 - 1560
1250	combination (400+400+450)	3 - 80	625 - 1625
1300	combination (400+450+450)	3 - 80	650 - 1690
1350	combination (450+450+450)	3 - 80	675 - 1755
1425	combination (475+475+475)	3 - 80	713 - 1852
1450	combination (475+475+500)	3 - 80	725 - 1885
1500	combination (500+500+500)	3 - 80	750 - 1950
1560	combination (500+500+560)	3 - 80	780 - 2028
1620	combination (500+560+560)	3 - 80	810 - 2106
1680	combination (560+560+560)	3 - 80	840 - 2184
450 ※2	High-COP combination (224+224)	2 - 60	360 - 900
500 ※2	High-COP combination (224+280)	2 - 53	400 - 800
560 ※2	High-COP combination (280+280)	2 - 59	448 - 896
615 ※2	High-COP combination (280+335)	2 - 65	492 - 984
670 ※2	High-COP combination (335+335)	2 - 71	536 - 1072
735 ※2	High-COP combination (224+224+280)	3 - 78	588 - 1176
800 ※2	High-COP combination (224+280+280)	3 - 80	640 - 1280
850 ※2	High-COP combination (280+280+280)	3 - 80	680 - 1360
900 ※2	High-COP combination (280+280+335)	3 - 80	720 - 1440
950 ※2	High-COP combination (280+335+335)	3 - 80	760 - 1520
1000 ※2	High-COP combination (335+335+335)	3 - 80	800 - 1300

※1 When connecting the indoor unit type FDK, FDFL, FDFU or FDFW series, limit the connectable capacity not higher than130%.

※2 When using in combination with the high efficiency function, turn ON the dip SW6-3 both on the master and slave units.

[Option parts]

Refrigerant distribution piping components supplied as option parts will become necessary in installing the unit. As refrigerant distribution piping components, branching pipe sets (model type: DOS) for the outdoor unit side piping, branching pipe sets (model type: DIS) for the indoor unit side piping are available. Select according to the application. Please refer to "4. Refrigerant piping work" in selecting. If you are uncertain, please do not hesitate to consult with your distributor or the manufacturer. Please use refrigerant branching sets and header sets designed exclusively for R410A without fail.

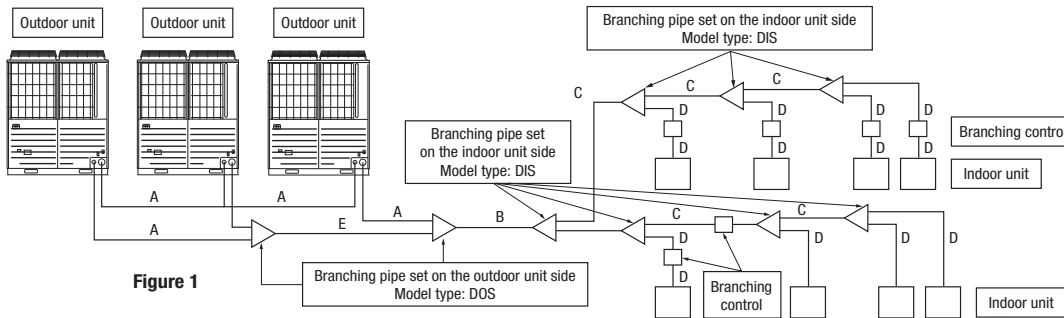

2. INSTALLATION LOCATION (Obtain approval from the customer when selecting the installation area.)

2-1. Selecting the installation location

- Where air is not trapped.
- Where the installation fittings can be firmly installed.
- Where wind does not hinder the intake and outlet pipes.
- Out of the heat range of other heat sources.
- Where strong winds will not blow against the outlet pipe.
- A place where stringent regulation of electric noises is applicable.
- Where it is safe for the drain water to be discharged.
- Where noise and hot air will not bother neighboring residents.
- Where snow will not accumulate.
- A place where no TV set or radio receiver is placed within 5m. (If electrical interference is caused, seek a place less likely to cause the problem)
- Do not install the unit in places which exposed to sea breeze (e.g. coastal area) or calcium chloride (e.g. snow melting agent), exposed to ammonia substance (e.g. organic fertilizer).

Please note

- a) A four-sided enclosure cannot be used. Leave a space of at least 1m above the unit.
- b) If there is a danger of a short-circuit, then install a wind direction variable adapter.
- c) When installing multiple units, provide sufficient intake space so that a short-circuit does not occur.
- d) In areas where there is snowfall, install the unit in a frame or under a snow hood to prevent snow from accumulating on it. (Inhibition of collective drain discharge in a snowy country)
- e) Do not install the equipment in areas where there is a danger for potential explosive atmosphere.
- * Please ask your distributor about optional parts such as wind vane adapters, snow guard hoods, etc.

CAUTION

Please leave sufficient clearance around the unit without fail. Otherwise, a risk of compressor and/or electric component failure may arise.

2-2. Installation space (service space) example

Please secure sufficient clearance (room for maintenance work, passage, draft and piping). (If your installation site does not fulfill the installation condition requirements set out on this drawing, please consult with your distributor or the manufacturer)

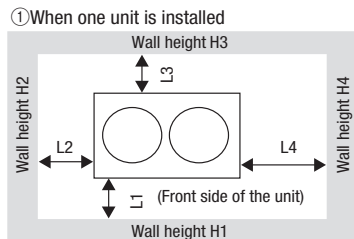

Example installation		I	II	III
Dimensions				
L1		500	500	Open
L2		10 (30)	50	10 (30)
L3		100	50	100
L4		10 (30)	50	Open
H1		1500	1500	Open
H2		No limit	No limit	No limit
H3		1000	1000	No limit
H4		No limit	No limit	Open

(): In case it is the promised installation location that the outdoor unit is used on conditions with the ambient temperature of 43°C or more.

For a normal installation, leave a 10 mm or wider space on both sides of the unit (L5 and L6) as workspace. It is also possible to install at a 0mm interval (continuous installation) with future renewal, etc. in mind.

For your information: the footprint of an outdoor unit is 1350x720 for all models throughout the series (224-670).

2) When more than one unit are installed

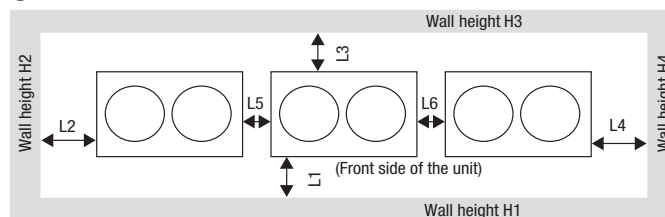

Example installation		I	II
Dimensions			
L1		500	Open
L2		10 (30)	200
L3		100	300
L4		10 (30)	Open
L5		10 (30)	400
L6		10 (30)	400
H1		1500	Open
H2		No limit	No limit
H3		1000	No limit
H4		No limit	Open

(): In case it is the promised installation location that the outdoor unit is used on conditions with the ambient temperature of 43°C or more.

3. Unit delivery and installation

CAUTION When a unit is hoisted with slings for haulage, please take into consideration the offset of its gravity center position. If not properly balanced, the unit can be thrown off-balance and fall.

3-1. Delivery

- By defining a cartage path, carry in the entire package containing a unit to its installation point.
- In slinging a unit, use two canvas belts with plates, cloth pads or other protections applied to the unit to prevent damage.

Please note

- a) Please do not fail to put belts through the rectangular holes of a unit's anchoring legs.
- b) Apply cloth pads between a canvas belt and a unit to prevent damage.



3-2. Notabilia for installation

(1) Anchor bolt positions

- Use four anchor bolts (M10) to fix an outdoor unit's anchoring legs at all times. Ideally, an anchor bolt should protrude 20mm.

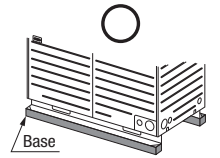
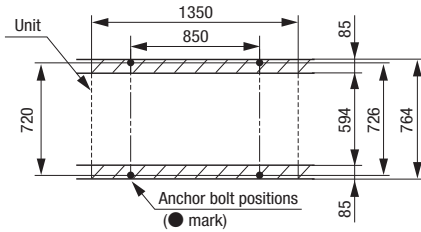

Normally, it is desirable that a base as specified in the drawing above is provided.

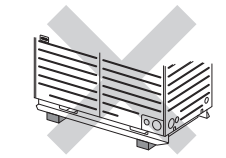
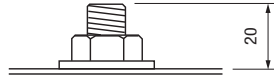

A base used for a former model is wrongly oriented and not acceptable.

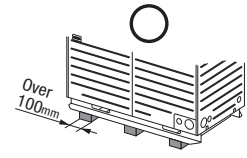

Please use it for renewal installation. (Please add a base on the center) It is necessary to prevent sagging.

(2) Base

- Please install a unit after ascertaining that the bases have been made to sufficient strength and level to ensure the unit against vibration or noise generation.
- Please construct a base to the size of a shadowed area (the entire bottom area of an outdoor unit's anchoring leg) shown on the above drawing or larger.
- Please orient a base in the traversal direction (direction of W1350mm) of an outdoor unit as illustrated in the drawing above.

(3) Vibration isolating rubber

- A vibration isolating rubber must support an outdoor unit's anchoring leg by its entire bottom area.

Please note

- 1) Install a vibration isolating rubber in such a manner that the entire bottom area of an outdoor unit's anchoring leg will rest on it.
- 2) Do not install an outdoor unit in such a manner that a part of the bottom area of its anchoring leg is off a vibration isolating rubber.

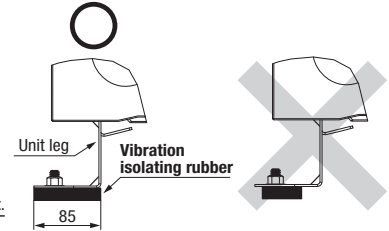

4. REFRIGERANT PIPING

4-1. Restrictions on the use of pipes

(1) Limitation on use of pipes

- In installing pipes, always observe the restrictions on the use of pipes specified in this Section (1) including Maximum length, Total pipe length, Allowable pipe length from the first branching, and Allowable elevation difference (head difference).

- Please avoid forming any trap () or bump () in piping as they can cause fluid stagnation.

- Maximum length (from an outdoor unit to the farthest indoor unit) 160 m or less as actual pipe length (185 m or less as equivalent pipe length)

(When an actual pipe length exceeds 90m, however, it is necessary to change the pipe size. Please determine the main pipe size by consulting with the Main Selection Reference Table set out in Section (3) (b).

- Total pipe length 1000 m or less
- Main pipe length 130 m or less
- Allowable pipe length from the first branching 90 m or less (However, difference between the longest and shortest piping 40 m or less)
- Allowable pipe length from branching controller to indoor unit 40 m or less
- Allowable elevation difference (head difference)
 - (a) When an outdoor unit is installed above 50 m or less
 - (b) When an outdoor unit is installed below 40 m or less ^{※1}

※1 It must be less than 30 m in the following conditions.

- (1) Conducting the cooling operation with the outdoor air temperature lower than 10°C.
- (2) The total capacity of indoor units more than 130%.
- (3) Pipe length from the first branching more than 40m.

- (c) Difference in the elevation of indoor units in a system 18 m or less
- (d) Elevation difference between the first branching point and the indoor unit 18 m or less ^{※2}
- (e) Elevation difference between the branching controller and the indoor unit.
 - When an indoor unit is installed above 1 m or less
 - When an indoor unit is installed below 4 m or less

- Restrictions on piping applicable to the section between an outdoor unit and an outdoor unit side branching pipe (combination unit)

- (a) Difference in the elevation 0.4 m or less ^{※3}
- (b) Distance between an outdoor unit and an outdoor unit side branching pipe ... 5 m or less
- (c) Length of oil equalization piping 10 m or less

※2 When all of following conditions (a) (b) and (c) are established, height difference between the branching nearest to the branching control (PFD box) and the indoor unit should be limited to 4m or less.

- (a) When the connected indoor unit model is 22 or 28.
- (b) When the piping length from the first branching and the indoor unit is 40m or more.
- (c) When the branching controller (PFD box) is installed above the branching nearest to the PFD box. In such case the size of discharge gas piping between the branching nearest to the branching control (PFD box) and the PFD box should be increased from $\phi 6.35$ to $\phi 9.52$.

※3 When using the outdoor units under 0°C, install them on the same level.

CAUTION

An installation not conforming to these restrictions can induce a compressor failure, which shall be excluded from the scope of warranty. Always observe the restrictions on the use of pipes in developing a system.

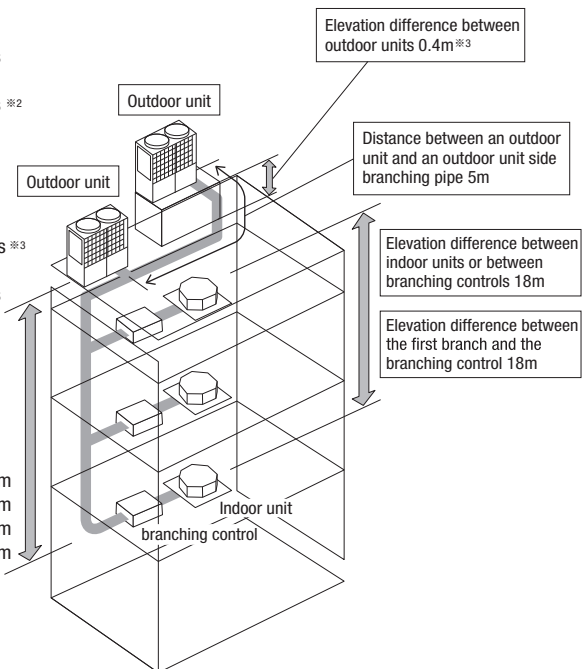

Important	
When the Additional refrigerant quantity (S + P × 1.4 + I) is over the following table, please separate the refrigerant line.	
Outdoor unit	S + P × 1.4 + I (kg)
224-670	50
735-1680	100

Difference in the elevation	50m
Actual length	160m
Equivalent length	185m
Total length	1000m

(2) Piping material selection



- Please use pipes clean on both the inside and outside and free from contaminants harmful to operation such as sulfur, oxides, dust, chips, oil, fat and water.
- Use the following material for refrigerant piping.
Material: phosphorus deoxidized seamless copper pipe (C1120T-0, 1/2H, JIS H 3300)
Use C1220T-1/2H for ϕ 19.05 or larger, or C1220T-0 for ϕ 15.88 or smaller
- Do not use ϕ 28.58 x t1.0, ϕ 31.8 x t1.1, ϕ 34.92 x t1.2 and ϕ 38.1 x t1.35 as a bent pipe.
- Thickness and size: Please select proper pipes according to the pipe size selection guideline.
(Since this unit uses R410A, always use 1/2H pipes of a specified minimum thickness or thicker for all pipes of ϕ 19.05 or larger, because the pressure resistance requirement is not satisfied with O-type pipes).
- For branching pipes, use a genuine branching pipe set or header set at all times. (option parts)
- For the handling of service valves, please refer to Section 4-3(4) Method of operating service valves.
- In installing pipes, observe the restrictions on the use of pipes set out in Section 1 (Maximum length, total pipe length, allowable pipe length from the first branching, allowable elevation difference (head difference)) without fail.
- Install a branching pipe set, paying attention to the direction of attachment, after you have perused through the installation manual supplied with it.

(3) Pipe size selection

(a) Outdoor unit – Outdoor unit side branching pipe: Section A in Figure 1

Please use a pipe conforming to the pipe size specified for outdoor unit connection.

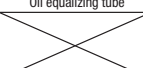
Indoor unit connecting pipe size table

Outdoor unit	Outdoor unit outlet pipe specifications							
	Suction gas pipe	Connection method	Discharge gas pipe	Connection method	Liquid pipe	Connection method	Oil equalizing tube	Connection method
224	ϕ 19.05 × t1.0	Blazed	ϕ 15.88 × t1.0	Blazed	ϕ 9.52 × t0.8	Flare		
280	ϕ 22.22 × t1.0		ϕ 19.05 × t1.0					
335	ϕ 25.4 (ϕ 22.22) × t1.0		ϕ 22.22 × t1.0					
400	ϕ 25.4 (ϕ 28.58) × t1.0							
450	ϕ 28.58 × t1.0							
475								
500								
560								
615								
670	ϕ 25.4 (ϕ 22.22) × t1.0		ϕ 9.52 × t0.8 ※1		Flare			

Pipe sizes applicable to European installations are shown in parentheses.

Please use C1220T-1/2H for ϕ 19.05 or larger pipes.

※1: Please connect the master and slave units with an oil equalization pipe, when they are used in a combined installation.

(It is not required, when a unit is used as a stand alone installation)

(b) Main (Outdoor unit side branching pipe – Indoor unit side first branching pipe): Section B in Figure 1

If the longest distance (measured between the outdoor unit and the farthest indoor unit) is 90m or longer (actual length), please change the main pipe size according to the table below.

※Even if the longest distance exceeds 90m (actual length), you need not change the size of discharge gas pipes.

Outdoor unit	Main pipe size (normal)			Pipe size for an actual length of 90m or longer		
	Suction gas pipe	Discharge gas pipe	Liquid pipe	Suction gas pipe	Discharge gas pipe	Liquid pipe
224	ϕ 19.05 × t1.0	ϕ 15.88 × t1.0	ϕ 9.52 × t0.8	ϕ 22.22 × t1.0	ϕ 15.88 × t1.0	ϕ 12.7 × t0.8
280	ϕ 22.22 × t1.0	ϕ 19.05 × t1.0		ϕ 25.4 (ϕ 22.22) × t1.0	ϕ 19.05 × t1.0	
335	ϕ 25.4 (ϕ 22.22) × t1.0					
400	ϕ 25.4 (ϕ 28.58) × t1.0	ϕ 22.22 × t1.0	ϕ 12.7 × t0.8	ϕ 28.58 × t1.0	ϕ 22.22 × t1.0	ϕ 15.88 × t1.0
450	ϕ 28.58 × t1.0					
475						
500						
560						
615						
670	ϕ 25.4 (ϕ 22.22) × t1.0					
735	ϕ 31.8 × t1.1 (ϕ 34.92 × t1.2)	ϕ 28.58 (ϕ 25.4) × t1.0	ϕ 15.88 × t1.0	ϕ 28.58 × t1.0	ϕ 19.05 × t1.0	
800		ϕ 28.58 × t1.0				
850						
900						
950						
1000	ϕ 38.1 × t1.35 (ϕ 34.92 × t1.2)	ϕ 31.8 × t1.1 (ϕ 28.58 × t1.0)	ϕ 19.05 × t1.0	ϕ 38.1 × t1.35 (ϕ 34.92 × t1.2)	ϕ 31.8 × t1.1 (ϕ 28.58 × t1.0)	ϕ 22.22 × t1.0
1060						
1120						
1200						
1350						
1425						
1450						
1500						
1560						
1620						
1680						

Please use C1220T-1/2H for ϕ 19.05 or larger pipes.

(c) Indoor unit side first branching pipe – Indoor unit side branching pipe: Section C in Figure 1

Please choose from the table below an appropriate pipe size as determined by the total capacity of indoor units connected downstream, provided, however, that the pipe size for this section should not exceed the main size (Section B in Figure 1).

- In the downstream of a branching control, no gas discharge pipe needs to be connected.

Total capacity of indoor units	Suction gas pipe (gas pipe)	Discharge gas pipe	Liquid pipe
Less than 70	φ 12.7 × t0.8	φ 9.52 × t0.8	φ 9.52 × t0.8
70 or more but less than 180	φ 15.88 × t1.0	φ 12.7 × t0.8	
180 or more but less than 371	φ 19.05 × t1.0 *1	φ 15.88 × t1.0	φ 12.7 × t0.8
371 or more but less than 540	φ 25.4 (φ 28.58) × t1.0	φ 22.22 × t1.0	φ 15.88 × t1.0
540 or more but less than 700	φ 28.58 × t1.0	φ 25.4 (φ 22.22) × t1.0	
700 or more but less than 1100	φ 31.8 × t1.1 (φ 34.92 × t1.2)	φ 28.58 × t1.0	φ 19.05 × t1.0
1100 or more	φ 38.1 × t1.35 (φ 34.92 × t1.2)	φ 31.8 × t1.1 (φ 28.58 × t1.0)	

Please use C1220T-1/2H for φ 19.05 or larger pipes.

*1: When connecting indoor units of 280 at the downstream and the main gas pipe is of φ22.22 or larger, use the pipe of φ22.22x t1.0.

(d) Indoor unit side branching pipe – Indoor unit: Section D in Figure 1

Indoor unit connection pipe size table

- In the downstream of a branching control, no gas discharge pipe needs to be connected.

Indoor unit	Capacity	Suction gas pipe (gas pipe)	Discharge gas pipe	Liquid pipe
	15, 22, 28	φ 9.52 × t0.8	φ 6.35 × t0.8 *2	φ 6.35 × t0.8
36, 45, 56	φ 12.7 × t0.8	φ 9.52 × t0.8		
	71, 80, 90, 112, 140, 160	φ 15.88 × t1.0	φ 12.7 × t0.8	φ 9.52 × t0.8
	224	φ 19.05 × t1.0	φ 15.88 × t1.0	
	280	φ 22.22 × t1.0	φ 19.05 × t1.0	

Please use C1220T-1/2H for φ 19.05 or larger pipes.

*2: When the pipe length after first branching is 40 m or more, Use a pipe of φ 9.52 x t0.8.

(4) Selection of an outdoor unit side branching pipe set

This branching pipe set will always become necessary when units are used in combination. (When a unit is used as a standalone installation, it is not required)

Outdoor unit	Branching pipe set
For two units	DOS-2A-3-R
For three units	DOS-3A-3-R

Please note

- a) In connecting an outdoor unit, please use a pipe conforming to the pipe size specified for outdoor unit connection.
- b) Choose a different-diameter pipe joint matching a main pipe size specified in Section (3) (b) in installing pipes (= main pipes) on the indoor unit side.
- c) Always install branching joints (for suction gas, discharge gas and liquid) in such a manner that they form either correct horizontal or vertical branch.

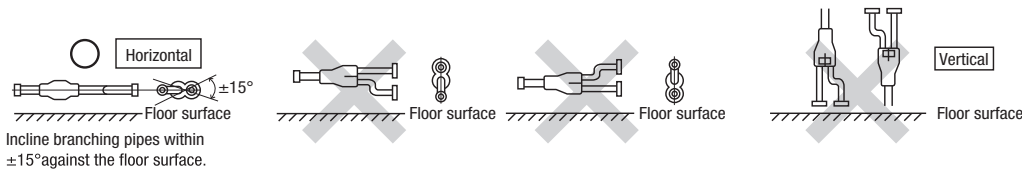

(5) Selection of an indoor unit side branching pipe set

(a) Method of selecting a branching pipe set

- As an appropriate branching pipe size varies with the connected capacity (total capacity connected downstream), determine a size from the following table.

① In the upstream of a branching control

Total capacity downstream	Branching pipe set model type
Less than 180	DIS-22-1-RG
180 or more but less than 371	DIS-180-1-RG
371 or more but less than 540	DIS-371-2-RG
540 or more	DIS-540-2-RG

② In the downstream of a branching control

Total capacity downstream	Branching pipe set model type
Less than 180	DIS-22-1G
180 or more but less than 371	DIS-180-1G
371 or more but less than 540	DIS-371-1G
540 or more	DIS-540-3

Please note

- a) In connecting an indoor unit with the indoor unit side branching pipe set, please use a pipe conforming to the pipe size specified for indoor unit connection.
- b) Always install branching joints (for suction gas, discharge gas and liquid) in such a manner that they form **either correct horizontal or vertical branch.**



(6) Selection of a branching control

- Select an appropriate one according to the combined total capacity of the indoor units connected downstream.
- The numbers of indoor units that can be connected to branching controls are depicted in the table below.
- No liquid pipe needs to be connected to a branching control.
- In the downstream of a branching control, no discharge gas pipe needs to be connected.
- Do not run the unit, while a branching control is yet to be connected with indoor units.
- Restriction on the number of branching controls to be connected to the outdoor unit is as follows.

Total capacity downstream	Branching control model type	Number of connectable units
Less than 112	PFD1124-E	1 - 5
112 or more but less than 180	PFD1804-E	1 - 8
180 or more but less than 280	PFD2804-E	1 - 10

Outdoor unit	Minimum number of connectable branching controls ※
- 280	2
- 560	4
- 850	6
- 1120	8
- 1680	10

※ For PFD1124 × 4-E model, calculate the number of units taking 1 branching control as 4 controls in this limit.

4-2. Pipe connection position and pipe direction

(1) Pipe connecting position and pipe outgoing direction

Although this drawing illustrates an installation involving a 450 or smaller capacity unit, an installation involving a 504 or a larger capacity unit should be arranged in the same manner as long as pipe connection points and directions are concerned, except that the height of a unit is different. Measurements in [] indicate those of a 504 or larger capacity unit.

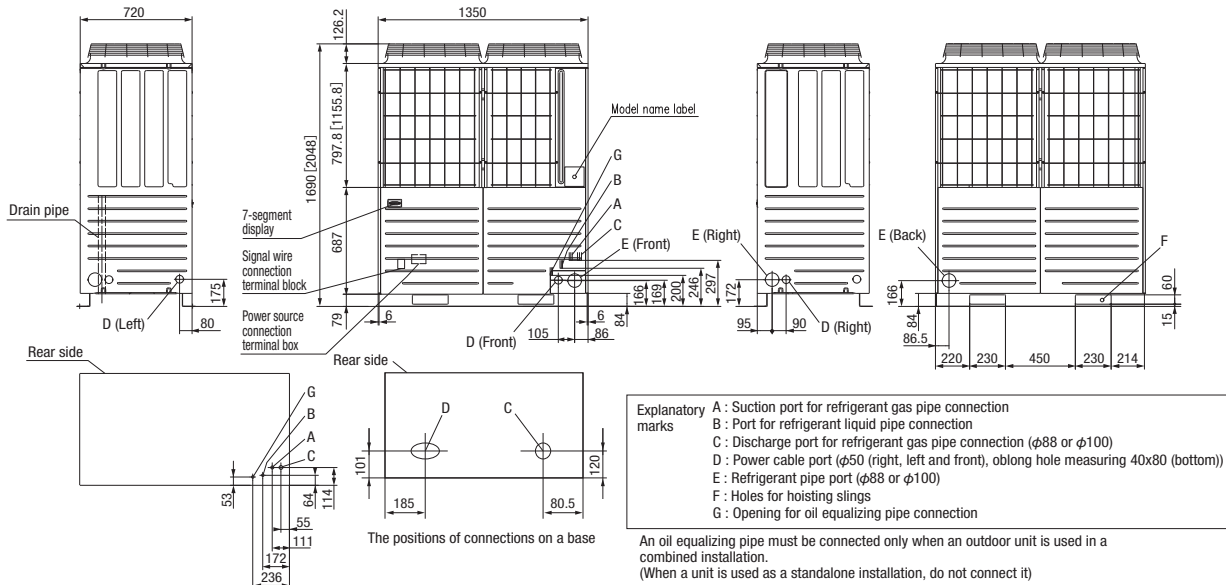

- A pipe can be laid through the front, right, bottom or rear of a unit as illustrated on the above drawings.
- In laying pipes on the installation site, cut off the casing's half blank (φ88 or φ100) that covers a hole for pipe penetration with nippers.
- When there is a danger that a small animal enters from the pipe port, cover the port with appropriate blocking materials (to be arranged on the user's part).
- Use an elbow (to be arranged on the user's part) to connect control valves to the piping.
- In anchoring piping on the installation site, give 1.5m or a longer distance between an outdoor unit and an anchoring point where the piping is secured as illustrated below. (A failure to observe this instruction may result in a pipe fracture depending on a method of isolating vibrations employed.)
- The pipe should be anchored every 1.5m or less to isolate the vibration.

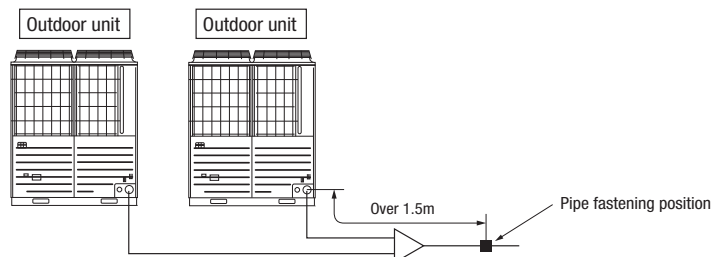

- Connect pipes between combined units, with care for the followings.
 - On combination units, it must be secured a straight pipe section of 500 mm or more before a branch pipe (Type DOS) for both gas pipe and liquid pipe as shown below.
 - On the pipe connection system of combination units, place the outdoor unit of which the capacity is the smallest among combined outdoor units, closer to the indoor unit, and place the outdoor unit of which the capacity is the largest among combined outdoor units, far from the indoor unit. (Connecting positions are not specified when the capacities are same.)
(Example) As shown below, in case of P1300 (P400 + P450 + P450), place the outdoor unit P400 closer to the indoor unit and place the outdoor unit P450 far from the indoor unit in the pipe connection system.
 - On the pipe connection system for combination of 3 units, use a branch pipe of which the pipe diameter is different after the pipe branching, for the branch pipe (branch pipe 1) located the closest to the indoor unit. It is necessary also to connect a thin pipe to the outdoor unit and to connect a thick pipe to next branch pipe.
 - It must be no longer than 5m the length of pipe from the branching pipe 1 to the outdoor unit. ($L_1 \leq 5$ m, $L_2 + L_4 \leq 5$ m, $L_3 + L_4 \leq 5$ m) It must be no longer than 10 m the length of oil equalizing pipes between outdoor units. ($L_a + L_b \leq 10$ m, $L_b + L_c \leq 10$ m, $L_a + L_c \leq 10$ m)
In case of P1300 three combination unit:

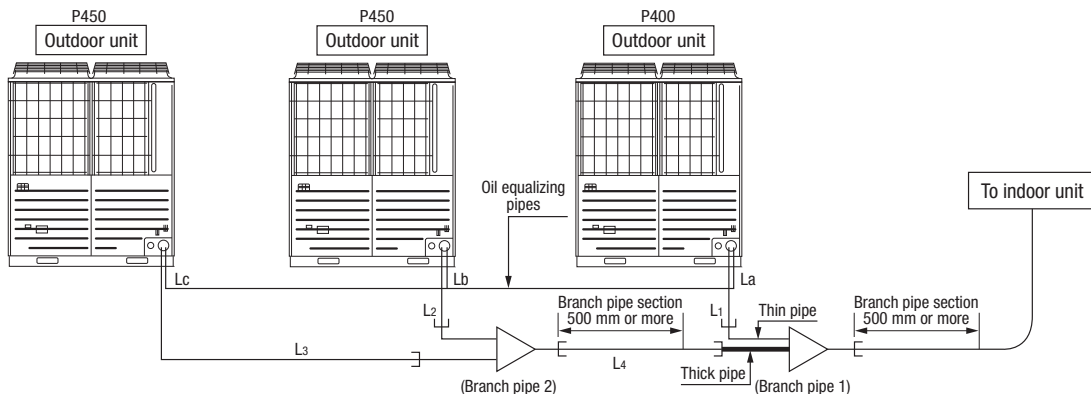

(2) Piping work

Important

CAUTION

If you tighten it without using double spanners, you may deform the service valve, which can cause an inflow of nitrogen gas into the outdoor unit.

- Please take care so that installed pipes may not touch components within a unit.
- **In laying pipes on the installation site, keep the service valves shut all the time.**
- Give **sufficient protections** (compressed and brazed or by an adhesive tape) **to pipe ends so that any water or foreign matters may not enter the pipes.**
- In bending a pipe, bend it **to the largest possible radius (at least four times the pipe diameter)**. Do not bend a pipe repeatedly to correct its form.
- An outdoor unit's liquid pipe and liquid refrigerant piping are to be flare connected. Flare a pipe after engaging a flare nut onto it. A flare size for R410A is different from that for conventional R407C. Although we recommend the use of flaring tools developed specifically for R410A, conventional flaring tools can also be used by adjusting the measurement of protrusion B with a protrusion control gauge.
- Tighten a flare joint securely **with two spanners**. Observe flare nut tightening torque specified in the table below.

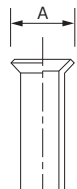

Flared pipe end: A (mm)	
Copper pipe outer diameter	A
φ 6.35	0 - 0.4
φ 9.52	9.1
φ 12.7	13.2
φ 15.88	16.6
φ 19.7	19.7

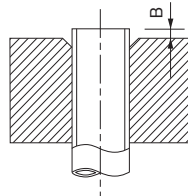

Copper pipe outer diameter	Copper pipe protrusion for flaring: B (mm)	
	In the case of a rigid (clutch) type	
	With an R410A tool	With a conventional tool
φ 6.35	0 - 0.5	0.7 - 1.3
φ 9.52		
φ 12.7		
φ 15.88		
φ 19.7		

Tightening torque (N·m)

Service valve size (mm)	Tightening torque (N·m)	Tightening angle (°)	Recommended length of tool handle (mm)
Ø6.35 (1/4")	14 - 18	45 - 60	150
Ø9.52 (3/8")	34 - 42	30 - 45	200
Ø12.7 (1/2")	49 - 61	30 - 45	250
Ø15.88 (5/8")	68 - 82	15 - 20	300
Ø19.05 (3/4")	100 - 120	15 - 20	450

Do not hold the valve cap area with a spanner.

Use a torque wrench. If a torque wrench is not available, fasten the flare nut manually first and then tighten it further, using the left table as a guide.

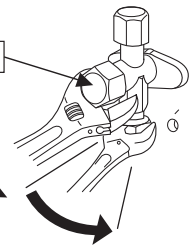

- Do not apply any oil on a flare joint.
- Pipes are to be brazed to connect an outdoor unit's gas pipe with refrigerant piping or refrigerant piping with a branching pipe set.
- **Blazing must be performed under a nitrogen gas flow.** Without nitrogen gas, a large quantity of foreign matters (oxidized film) are created, causing a critical failure from capillary tube or expansion valve clogging.
- Brazing of the service valve and the pipes should be performed while cooling the valve body with a wet towel.
- Perform flushing. To flush the piping, charge nitrogen gas at about 0.02MPa with a pipe end closed with a hand. When pressure inside builds up to a sufficient level, remove the hand to flush. (in flushing a pipe, close the other end of the pipe with a plug).

Operation procedure

- 1 **In laying pipes on the installation site, keep the service valves shut all the time.**
- 2 **Blazing must be performed under a nitrogen gas flow.** Without nitrogen gas, a large quantity of foreign matters (oxidized film) are created, causing a critical failure from capillary tube or expansion valve clogging.

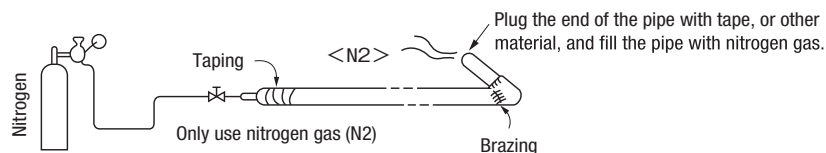

- 3 Give **sufficient protections** (compressed and brazed or with an adhesive tape) **so that water or foreign matters may not enter the piping.**



- 4 Perform flushing. To flush the piping, charge nitrogen gas at about 0.02MPa with a pipe end closed with a hand. When pressure inside builds up to a sufficient level, remove the hand to flush. (in flushing a pipe, close the other end of the pipe with a plug).

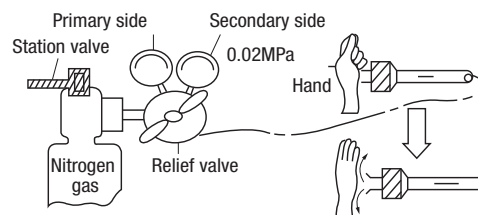

- 5 In brazing an service valve and a pipe, **brazed them with the valve main body cooled with a wet towel or the like.**

4-3. Air tightness test and air purge

(1) Air tightness test

- ① Although an outdoor unit itself has been tested for air tightness at the factory, please check the connected pipes and indoor units for air tightness from the check joint of the service valve on the outdoor unit side. While conducting a test, **keep the service valve shut all the time.**
- ② Since refrigerant piping is pressurized to the design pressure of a unit with nitrogen gas for testing air tightness, please connect instruments according to the drawing below. Under no circumstances should chlorine-based refrigerant, oxygen or any other combustible gas be used to pressurize a system. **Keep the service valve shut all the time.** Do not open it under any circumstances. **Be sure to pressurize all of the liquid, gas and oil equalizing pipes.**
- ③ In pressurizing the piping, do not apply the specified level of pressure all at once, but gradually raise pressure.
 - a) **Raise the pressure to 0.5 MPa, and then stop. Leave it for five minutes or more** to see if the pressure drops.
 - b) **Then raise the pressure to 1.5 MPa, and stop. Leave it for five more minutes** to see if the pressure drops.
 - c) Then raise the pressure to the specified level (4.15 MPa), and record the ambient temperature and the pressure.
 - d) **If no pressure drop is observed with an installation pressurized to the specified level and left for about one day, it is acceptable.** When the ambient temperature changes 1°C, the pressure also changes approximately 0.01 MPa. The pressure, if changed, should be compensated for.
 - e) If a pressure drop is observed in checking e) and a) – d), a leak exists somewhere. Find a leak by applying bubble test liquid to welded parts and flare joints and repair it. After repair, conduct an air-tightness test again.
- ④ Always pull air from the pipes after the airtightness test.

CAUTION
Applying excessive pressure can cause an inflow of nitrogen gas into an outdoor unit.

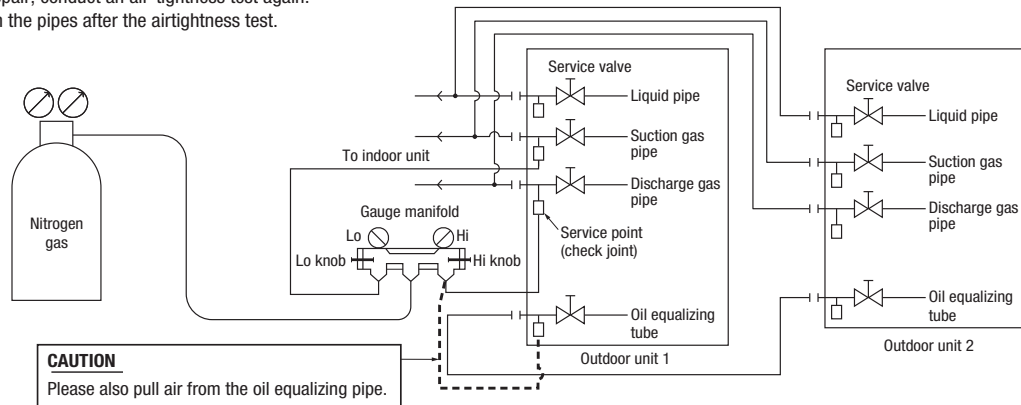

(2) Vacuuming

Please pull air **from the check joints of the service valves on both liquid and gas sides.**
Please also **pull air from the oil equalizing pipe.** (Please pull air separately from the rest of the piping by using the oil equalizing valve check joint)

< Work flow >

When the system has remaining moisture inside or a leaky point, the vacuum gauge indicator will rise. Check the system for a leaky point and then draw air to create a vacuum again.

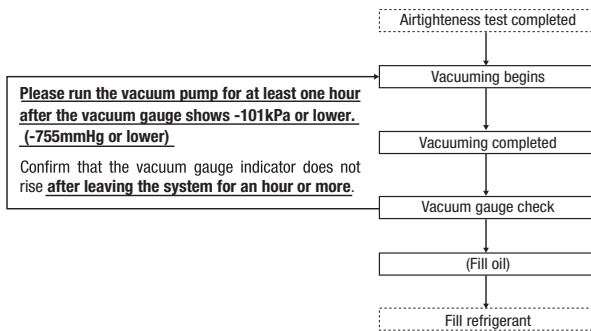

CAUTION
Insufficient vacuuming may result in poor performance falling short of the design capacity, pipe clogging due to residue moisture and/or a compressor failure.

Pay attention to the following points in addition to the above for the R410A and compatible machines.

- To prevent a different oil from entering, please assign dedicated tools, etc. to each refrigerant type. Under no circumstances must a gauge manifold and a charge hose in particular be shared with other refrigerant types (R22, R407C, etc.).
- Use a counterflow prevention adapter to prevent vacuum pump oil from entering the refrigerant system.

(3) Additional oil charge

When the total pipe length is longer than 510 m, charge 1,000 cc of M-MA32R refrigeration machine oil from the check joint of gas pipe service valve after the vacuuming.

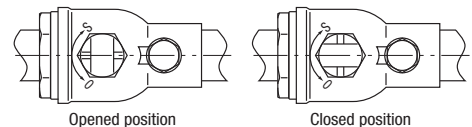

(4) Method of operating service valves

Method of opening/closing a valve

- Remove the cap, turn the gas pipe side until it comes to the "Closed" position as indicated in the drawing on the right.
- For the liquid side pipe and oil equalizing pipe side, turn with a hexagonal wrench until the shaft stops. If excessive force is applied, the valve main body can be damaged. Always use a dedicated special tool.
- Tighten the cap securely.

For tightening torque, refer to the table below.

		Tightening torque N · m		
		Shaft (valve main body)	Cap (lid)	Cap nut (check joint section)
For gas pipes		7 or less	30 or less	13
For liquid pipes	φ 9.52	6 - 8	20 - 30	10 - 12
	φ 12.7	14 - 16	25 - 35	
For oil equalizing pipe		6 - 8	20 - 30	10 - 12

For fastening torque of a flare nut, please refer to Section 4-2 (2) Piping work on site.

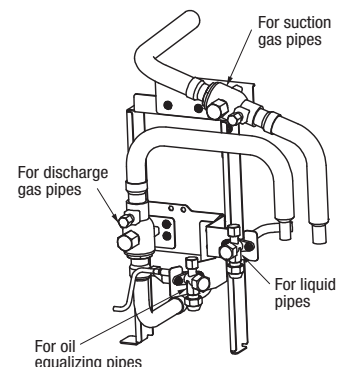

4-4. Additional refrigerant charge

Charge additional refrigerant **in the liquid state**.

Be sure to measure the quantity **with a scale in adding refrigerant**.

If you cannot charge all refrigerant with the outdoor unit lying idle, charge it with the unit running in the test run mode. (For the test run method, please refer to Section 8)

If operated for a long time with insufficient refrigerant the compressor will be damaged. (In particular, when adding refrigerant during operation, complete the job within 30min.)

This unit contains **<11.5kg/unit> of refrigerant**.

Determine the amount of refrigerant to be charged additionally using the following formula and put down the amount of refrigerant added on the refrigerant charge volume recording plate provided on the back the front panel.

● Adding additional refrigerant

Charge additional refrigerant according to the size and length of the liquid piping and unit capacity.

Determine additional charge volume by rounding to the nearest 0.1 kg.

$$\text{Additional fill quantity (kg)} = S + P \times 1.4 + I$$

S: standard additional refrigerant quantity (kg), P: Additional refrigerant quantity for piping (kg)

$$S = (N1 \times 2.1) + (N2 \times 3.6) + (N3 \times 8.7)$$

N1: Number of model1 units (units)

Model 1	Refrigerant (kg)
224	2.1
280	
335	

N2: Number of model2 units (units)

Model 2	Refrigerant (kg)
400	3.6
450	

N3: Number of model3 units (units)

Model 3	Refrigerant (kg)
475	8.7
500	
560	
615	
670	

$$P = (L1 \times 0.37) + (L2 \times 0.26) + (L3 \times 0.18) + (L4 \times 0.12) + (L5 \times 0.059) + (L6 \times 0.022)$$

L1 : φ 22.22 total length (m) L2 : φ 19.05 total length (m) L3 : φ 15.88 total length (m)

L4 : φ 12.7 total length (m) L5 : φ 9.52 total length (m) L6 : φ 6.35 total length (m)

Refrigerant liquid pipe size	φ 22.22	φ 19.05	φ 15.88	φ 12.7	φ 9.52	φ 6.35	Remarks
Additional fill quantity (kg/m)	0.37	0.26	0.18	0.12	0.059	0.022	

I: Additional refrigerant quantity for indoor units (kg)

If the total indoor units capacity is larger than 1.3 times of outdoor unit capacity, then calculate the additional refrigerant quantity for indoor units.

$$D = \{(\text{Total indoor units capacity}) - (\text{outdoor unit capacity}) \times 1.3\}$$

$$I = D \times 0.01$$

When $D > 0$, calculate I using the above equation;

When $D \leq 0$, take it as $I = 0$.

<Example>

When you connect FDC400 to FDT140 x 4 units:

$$D = 140 \times 4 - 400 \times 1.3 = 40 (> 0)$$

$$I = 40 \times 0.01 = 0.4 \text{ (kg)}$$

Important

When the Additional refrigerant quantity (S + P × 1.4 + I) is over the following table, please separate the refrigerant line.

Outdoor unit	S + P × 1.4 + I (kg)
224-670	50
735-1680	100

Pay attention to the following points in addition to the above for the R410A and compatible machines.

- To prevent a different oil from entering, please assign dedicated tools, etc. to each refrigerant type. Under no circumstances must a gauge manifold and a charge hose in particular be shared with other refrigerant types (R22, R407C, etc.).
- Refrigerant types are indicated by color at the top of the cylinder 5. (Pink for R410A). Always confirm this.
- Do not use a charge cylinder under any circumstances. There is a danger that the composition of the refrigerant will change when R410A is transferred to a cylinder.
- When charging refrigerant, use liquid refrigerant from a cylinder. If refrigerant is charged in a gas form, the composition may change considerably.

Please note

Put down on the refrigerant charge volume recording plate provided on the back of the front panel the amount of refrigerant calculated from the pipe length.

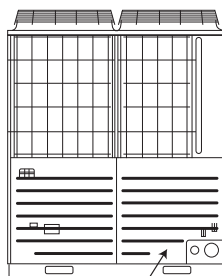

It is located in back of this front panel.

CAUTION

Be sure to record the refrigerant volume, because the information is necessary to perform the installation's maintenance service.

4-5. Heating and condensation prevention

- ① Dress refrigerant pipes (both gas and liquid pipes) for heat insulation and prevention of dew condensation.
 - Improper heat insulation/anti-dew dressing can result in a water leak or dripping causing damage to household effects, etc.
- ② Use a heat insulating material that can withstand 120°C or a higher temperature. Poor heat insulating capacity can cause heat insulation problems or cable deterioration.
 - a) The gas pipe can cause during a cooling operation dew condensation, which will become drain water causing a possible water-leak accident, or reach during a heating operation as high a temperature as 60°C to 110°C, posing a risk of burns, when touched accidentally. So, do not fail to dress it with a heat insulation material.
 - b) Wrap indoor units' flare joints with heat insulating parts (pipe cover) for heat insulation (both gas and liquid pipes).
 - c) Give heat insulation to both gas and liquid side pipes. Bundle a heat insulating material and a pipe tightly together so that no gaps may be left between them and wrap them together with a connecting cable by a dressing tape.
 - d) Although this air-conditioning unit has been tested under the JIS condensation test conditions, the dripping of water may occur when it is operated in a high-humidity atmosphere (23°C or a higher dew point temperature). In such a case, apply an additional heat insulation material of 10 to 20 mm thick to dress an indoor unit body, piping and drain pipes.

When the ambient dew point temperature becomes 28°C or higher, or the relative humidity becomes 80% or higher, add further 10 to 20 mm thick heat insulation material.

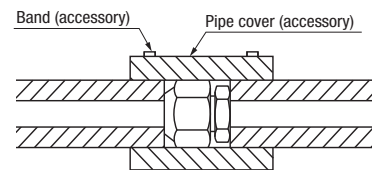
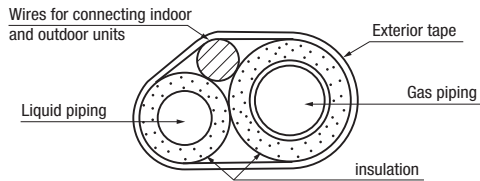

5. Drainage

- Where water drained from the outdoor unit may freeze, connect the drain pipe using option drain elbow and drain grommet.

6. ELECTRICAL WIRING WORK

Electrical installation work must be performed by an electrical installation service provider qualified by a power provider of the country.

Electrical installation work must be executed according to the technical standards and other regulations applicable to electrical installations in the country.

- ⚠ Please install an earth leakage breaker without fail.** The installation of an earth leakage breaker is compulsory in order to prevent electric shocks or fire accidents. (Since this unit employs inverter control, please **use an impulse withstanding type** to prevent an earth leakage breaker's false actuation.)

Please note

- a) Use only copper wires.
 - Do not use any supply cord lighter than one specified in parentheses for each type below.
 - braided cord (code designation 60245 IEC 51), if allowed in the relevant part 2;
 - ordinary tough rubber sheathed cord (code designation 60245 IEC 53);
 - flat twin tinsel cord (code designation 60227 IEC 41)
 - ordinary polyvinyl chloride sheathed cord (code designation 60227 IEC 53).
 - Please do not use anything lighter than polychloroprene sheathed flexible cord (cord designation 60245 IEC57) for supply cords of parts of appliances for outdoor use.
- b) **Use separate power sources for the indoor and outdoor units .**
- c) A grounding wire must be connected before connecting the power cable. Provide a grounding wire longer than the power cable.
- d) **The power sources for indoor units in the same system should turn on and off simultaneously .**
- e) Ground the unit. Do not connect the grounding wire to a gas pipe, water pipe, lightning rod or telephone grounding wire.
 - If improperly grounded, an electric shock or malfunction may result.
 - Never connect the grounding wire to a gas pipe because if gas leaks, it could cause explosion or ignition.
- f) **The installation of an impulse withstanding type earth leakage breaker is necessary.** A failure to install an earth leakage breaker can result in an accident such as an electric shock or a fire. Do not turn on the power until the electrical work is completed. Be sure to turn off the power when servicing.
- g) Please do not use a condensive capacitor for power factor improvement under any circumstances. (It does not improve power factor, while it can cause an abnormal overheat accident)
- h) For power source cables, use conduits.
- i) Please **do not lay electronic control cables (remote control and signaling wires) and other high current cables together outside the unit.** Laying them together can result in malfunctioning or a failure of the unit due to electric noises.
- j) Power cables and signaling wires must always be connected to the power cable terminal block and secured by cable fastening clamps provided in the unit.
- k) Fasten cables so that they may not touch the piping, etc.
- l) **When cables are connected, please make sure that all electrical components within the electrical component box are free of loose connector coupling or terminal connection** and then attach the cover securely. (Improper cover attachment can result in malfunctioning or a failure of the unit, if water penetrates into the box.)
- m) Make sure to use circuit breakers (earth leakage breaker and circuit breaker) of proper capacity. Use of breakers of larger capacity could result in trouble on components or fire accident. The circuit breaker should isolate all poles under over current.
- n) Install isolator or disconnect switch on the power source wiring in accordance with the local codes and regulations. The isolator should be locked in OFF state in accordance with EN60204-1.
- o) After maintenance, all wiring, wiring ties and the like, should be returned to their original state and wiring route, and the necessary clearance from all metal parts should be secured.

6-1. Wiring system diagrams

(Example of combination)

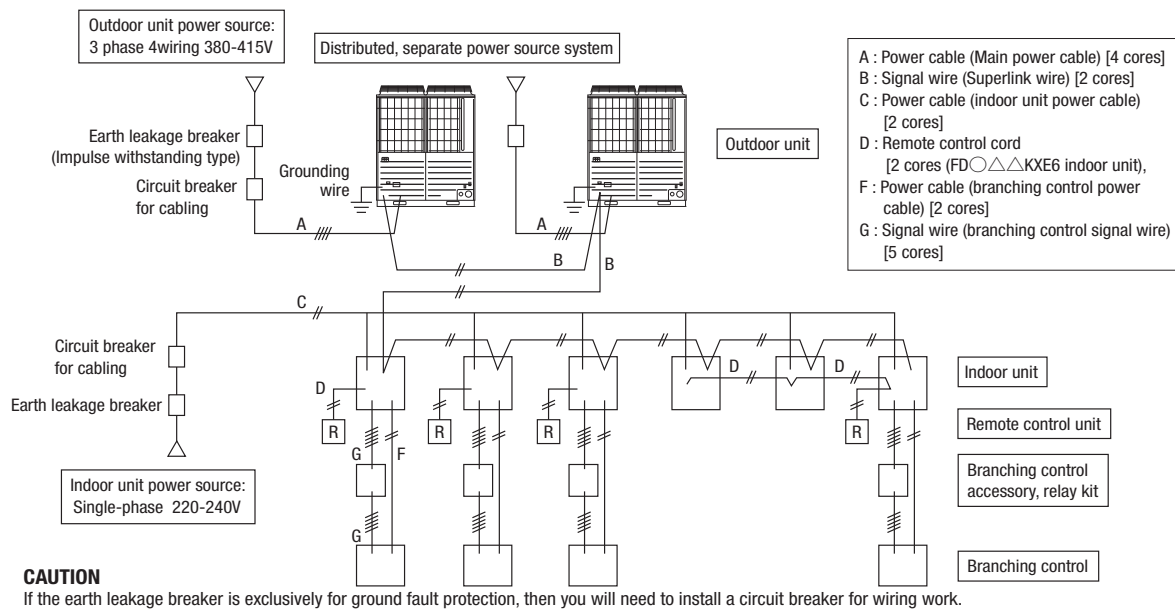

6-2. Method of connecting power cables

(1) Method of leading out cables

- As shown on the drawing in Section 4-2 (1), cables can be laid through the front, right, left or bottom casing.
- In wiring on the installation site, cut off a half-blank ($\phi 50$ or oblong hole measuring 40x80) covering a penetration of the casing with nippers.

(2) Notabilia in connecting power cables

Power cables must always be connected to the power cable terminal block and clamped outside the electrical component box. In connecting to the power cable terminal block, use round solderless terminals.

- Connect the ground wire before you connect the power cable. When you connect a grounding wire to a terminal block, use a grounding wire longer than the power cable so that it may not be subject to tension.
- Do not turn on power until installation work is completed. Turn off power to the unit before you service the unit.
- Ensure that the unit is properly grounded.
- Always connect power cables to the power terminal block.
- To connect a cable to the power terminal block, use a round crimp contact terminal.
- Use specified wires in wiring, and fasten them securely in such a manner that the terminal blocks are not subject to external force.
- In fastening a screw of a terminal block, use a correct-size driver. Fastening a screw of a terminal block with excessive force can break the screw.
- For the tightening torque of terminals, refer to the list shown at right.
- When electrical installation work is completed, make sure that all electrical components within the electrical component box are free of loose connector coupling or terminal connection.

FDC○○○KXZRE1 : Tightening torque (N · m)		
M3.5	Outdoor signal line terminal block	0.9 - 1.2
M6	Power cable terminal block, Earth wire	2.5 - 2.8

Request (FDC○○○KXZRE1)

- When connecting to the power supply terminal block, use the crimp terminals for M6 as shown at right.
- When connecting to the signal terminal block, use the crimp terminals for M3.5 as shown at right.

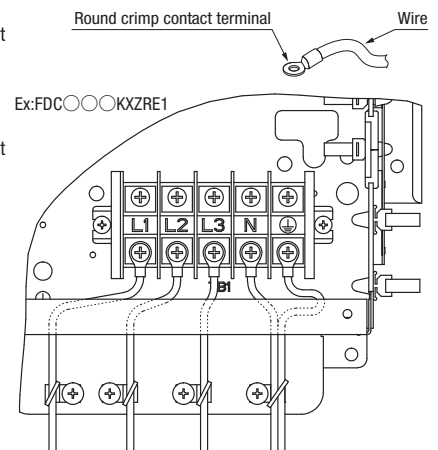
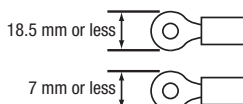

(3) Outdoor unit power source specifications : 3 phase 380-415V

Model	Power source	Cable size for power source (mm ²)	Wire length (m)	Moulded-case circuit breaker (A)		Earth leakage breaker	Earth wire	
				Rated current	Switch capacity		Size (mm ²)	Screw type
224	3 phase 4 wire 380-415V 50Hz/380V 60Hz	5.5	68	30	30	30A30mA less than 0.1 sec	3.5	M6
280		8	79	30	30	30A30mA less than 0.1 sec	3.5	M6
335		8	74	30	30	30A30mA less than 0.1 sec	3.5	M6
400		14	92	50	50	50A100mA less than 0.1 sec	3.5	M6
450		14	86	50	50	50A100mA less than 0.1 sec	3.5	M6
475		22	107	60	60	60A100mA less than 0.1 sec	5.5	M6
500		22	106	60	60	60A100mA less than 0.1 sec	5.5	M6
560		22	104	60	60	60A100mA less than 0.1 sec	5.5	M6
615		22	103	60	60	60A100mA less than 0.1 sec	5.5	M6
670		22	102	60	60	60A100mA less than 0.1 sec	5.5	M6

Please note

- a) The method of laying cables has been determined pursuant to the Japanese indoor wiring regulations (JEAC8001). (Please adapt it to the regulations in effect in each country)
- b) In the case of distributed, separate power source system, the listed data represent those of an outdoor unit.
- c) For details, please refer to the installation manual supplied with the indoor unit.

(4) Indoor unit power source specifications : Single phase 220-240V

Combined total capacity of indoor units	Cable size for power source (mm ²)	Wire length (m)	Moulded-case circuit breaker (For ground fault, overload and short circuit protection)	Signal wire size (mm ²)
Less than 7A	2	21	20A 100mA less than 0.1 sec	2cores x 0.75-2.0 [※]
Less than 11A	3.5	21	20A 100mA less than 0.1 sec	
Less than 12A	5.5	33	20A 100mA less than 0.1 sec	
Less than 16A	5.5	24	30A 100mA less than 0.1 sec	
Less than 19A	5.5	20	40A 100mA less than 0.1 sec	
Less than 22A	8	27	40A 100mA less than 0.1 sec	
Less than 28A	8	21	50A 100mA less than 0.1 sec	

※ Please use a shielded cable.

Please note

- a) The method of laying cables has been determined pursuant to the Japanese indoor wiring regulations (JEAC8001). (Please adapt it to the regulations in effect in each country)
- b) Wire length in the table above is the value for when the indoor unit is connect to the power cable in series also the wire size and minimum length when the power drop is less than 2% are shown. If the current exceeds the value in the table above, change the wire size according to the indoor wiring regulations. (Please adapt it to the regulations in effect in each country)
- c) For details, please refer to the installation manual supplied with the indoor unit.
- d) Wires connected to indoor units are allowed up to 5.5 mm². For 8 mm² or more, use a dedicated pull box and branch to indoor units with 5.5 mm² or less.

6-3. Method of connecting signaling wires

The communication protocol can be chosen from following two types. One of them is the conventional Superlink (hereinafter previous SL) and the other is the new Superlink II (hereinafter new SL). These two communication protocols have the following advantages and restrictions, so please choose a desirable one meeting your installation conditions such as connected indoor units and centralized controller. When signal cables are connected into a network involving outdoor units, indoor units or centralized control equipment that do not support new SL, please select communications in the previous SL mode, even if the refrigerant system is separated from theirs.

Communication protocol	Conventional communication protocol (previous SL)	New communication protocol (new SL)
Outdoor unit setting (SW5-5)	ON	OFF (Factory default)
No. of connectable indoor units	Max. 48	Max. 128
No. of connectable outdoor units in a network	Max. 48	Max. 32
Signal cable (total length)	Up to 1000m	Up to 1,500 m for 0.75 mm ² shielding wire (MWS) Up to 1,000 m for 1.25 mm ² shielding wire (MWS)
Signal cable (furthest length)	Up to 1000m	Up to 1000m
Connectable units to a network	Units not supporting new SL (FD○A△△KXE4-5 series) Units supporting new SL (FD○A△△KXE6 series, FD○A△△KXZ series) Can be used together.	Units supporting new SL (FD○A△△KXE6 series, FD○A△△KXZ series)

Note: For FDT224 and 280 models, calculate the number of units taking 1 indoor unit as 2 units for the sake of communication.

● **Signal cables are for DC 5 V. Never connect wires for 220/240 V or 380/415 V.** Protective fuse on the PCB will trip.

- ① Confirm that signal cables are prevented from applying 220/240 V or 380/415 V.
- ② Before turning the power on, check the resistance on the signal cable terminal block. If it is less than 100Ω, power source cables may be connected to the signal cable terminal block.

When units of FD○A△△KXE6 Series, FD○A△△KXE1 series are connected:

Standard resistance value=5,100/Number of connected units.

When units of FD○A△△KXE4 and 5 Series only are connected:

Standard resistance value=9,200/Number of connected units.

When units of FD○A△△KXE6 Series, FD○A△△KXE1 series and units of FD○A△△KXE4 and 5 Series are connected in a mixture:

Standard resistance value=46,000/[(Number of connected FD○A△△KXE4 and 5 Series units x 5) + (Number of connected FD○A△△KXE6 and KXZ Series units x 9)]

The number of connected units includes those of indoor units, outdoor units and SL devices.

If the resistance value is less than 100Ω, disconnect the signal cables temporarily to divide to more than one network, to reduce the number of indoor units on the same network, and check each network.

Indoor and outdoor units signal cables

- Connect the signal cable between indoor and outdoor units and the signal cable between outdoor units belonging to the same refrigerant line to A1 and B1.
- Connect the signal line between outdoor units on different refrigerant lines to A2 and B2.
- Please use a shielded cable for a signal line and connect a shielding earth at all the indoor units and outdoor units.

(1) When one outdoor unit is used.

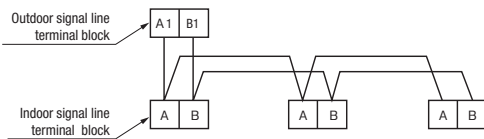

○ Indoor and outdoor signal lines do not have a polarity. Any of the connections in the following illustration can be made.

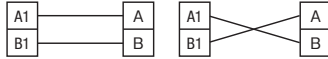

(3) The signal lines can also be connected using the method shown below.

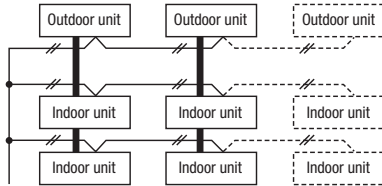

(2) When plural outdoor units are used

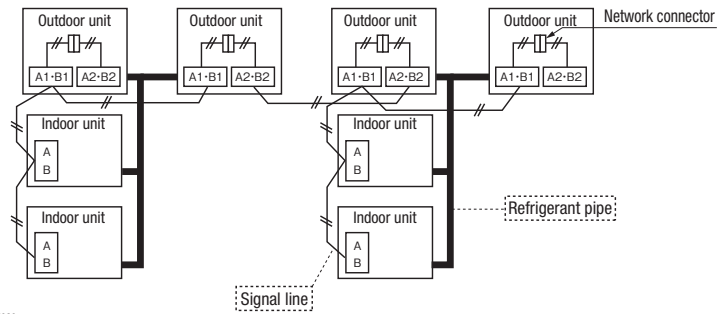

Important

○ Loop wiring prohibited.

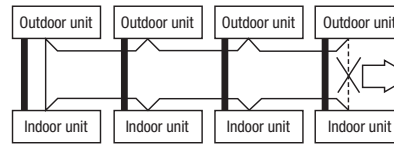

The signal lines cannot form a loop, so the wirings shown as in the diagram are prohibited.

Remote control wiring specifications

(1) A standard remote control wire is 0.3mm² x 2 cores (FD \bigcirc \triangle \triangle KXE6, KXZE1 indoor unit), 0.3mm² x 3 cores (FD \bigcirc A \triangle \triangle KXE4-5 indoor unit). It can be extended up to 600m. For a remote control wire exceeding 100m, please upgrade wire size as specified in the table below.

Length (m)	Wire size
	FD \bigcirc \triangle \triangle KXE6, KXZE1 indoor unit
100 to 200	0.5mm ² × 2 cores
To 300	0.75mm ² × 2 cores
To 400	1.25mm ² × 2 cores
To 600	2 mm ² × 2 cores

(2) When the remote control wire runs parallel to another power source wire or when it is subject to outside noise, such as from a high-frequency device, use shielded wire. (Be sure to ground only one end of the shielded wire.)

CAUTION In addition to a possible wiring error between indoor and outdoor units, there are other possibilities of erroneous wiring as illustrated below.

① Wrong wiring between signaling wires and remote control wires.

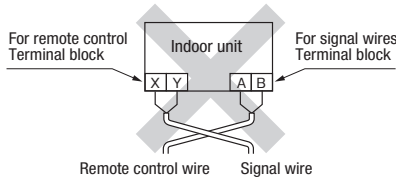

② Connecting power cables to the signaling wire terminal block.

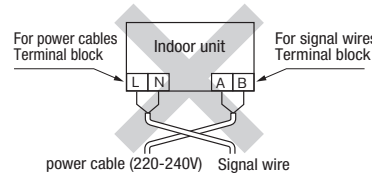

It will result in a blown signal line fuse (CNK).

7. CONTROL SETTINGS

7-1. Unit address setting

This control system controls the controllers of more than one air-conditioner's outdoor unit, indoor unit and remote control unit through communication control, using the microcomputers built in the respective controllers. Address setting needs to be done for both outdoor and indoor units. Turn on power in the order of the outdoor units and then the indoor units.

Use 1 minute as the rule of thumb for an interval between them.

The communication protocol can be chosen from following two types. One of them is the conventional communication protocol (previous SL) and the other is the new communication protocol (new SL). These two communication protocols have their own features and restrictions as shown by Table 6-3. Select them according to the indoor units and the central control to be connected.

When signal cables are connected into a network involving outdoor units, indoor units or central control equipment that do not support new SL, please select communications in the previous SL mode, even if the refrigerant system is separated from theirs.

When communication is established after setting addresses, check the communication protocol with the 7-segment display panel of the outdoor unit.

●Address setting methods

The following address setting methods can be used. The procedure for automatic address setting is different from the conventional one. Please use the automatic address setting function after reading this manual carefully.

Communication protocol		new SL		previous SL	
		Automatic	Manual	Automatic	Manual
When plural refrigerant systems are linked with signal lines (e.g., to implement central control)	Case 1 When signal lines linking plural refrigerant systems are provided between outdoor units. (When the network connector is disconnected, refrigerant systems are separated each other)	OK ^{※1}	OK	×	OK
	Case 2 When signal lines linking plural refrigerant systems are provided between indoor units.	×	OK	×	OK
When only one refrigerant system is involved (signal lines do not link plural refrigerant systems)		OK	OK	OK	OK

※1 Do not connect the signal line between outdoor units on the different refrigerant lines to A1 and B1. Do not connect the signal line between outdoor units on the same refrigerant line to A2 and B2. This may interrupt proper address setting. (Case 3)

Do not connect the signal line between indoor unit and outdoor unit to A2 and B2. This may interrupt proper address setting. (Case 4)

※2 In Case 2, automatic address setting is not available. Set addresses manually.

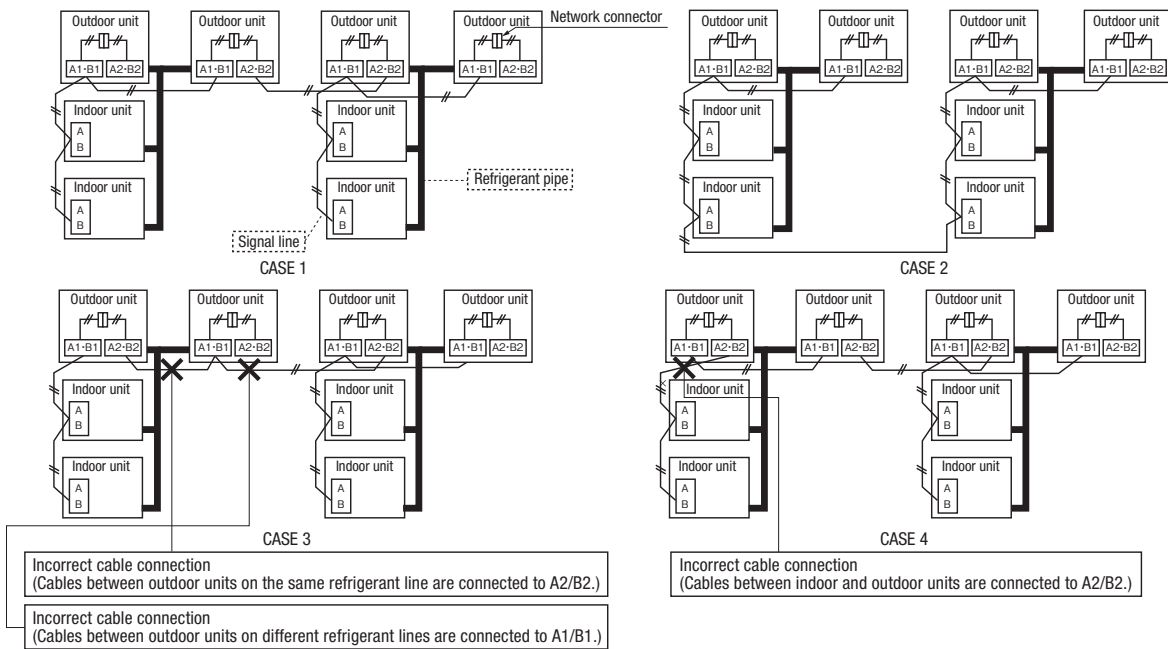

● **Address No. setting**

Set SW1 through 4 and SW5-2 provided on the PCB and SW1 & 2 provided on the outdoor unit PCB as shown in the drawings below.

Indoor PCB	SW1, 2 (blue)	For setting indoor No. (The ten's and one's)
	SW3, 4 (green)	For setting outdoor No. (The ten's and one's)
	SW5-2	Indoor No. switch (The hundred's Place) [OFF : 0, ON : 1]
Outdoor PCB	SW1, 2 (green)	For setting outdoor No. (The ten's and one's)

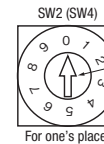
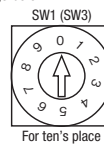

By inserting a flat driver (precision screw driver) into this groove and turn the arrow to point a desired number.

● **Summary of address setting methods (figures in [] should be used with previous SL)**

	Units supporting new SL			Units NOT supporting new SL		
	Indoor unit address setting		Outdoor unit address setting	Indoor unit address setting		Outdoor unit address setting
	Indoor No. switch	Outdoor No. switch	Outdoor No. switch	Indoor No. switch	Outdoor No. switch	Outdoor No. switch
Manual address setting (previous SL/new SL)	000~127[47]	00~31[47]	00~31[47]	00~47	00~47	00~47
Automatic address setting for single refrigerant system installation (previous SL/new SL)	000	49	49	49	49	49
Automatic address setting for multiple refrigerant systems installation (with new SL only)	000	49	00~31	×	×	×

Do not set numbers other than those shown in the table, or an error may be generated.

Note: When units supporting new SL are added to a network using previous SL such as one involving FD△A△KXE4-5 series units, choose previous SL for the communication protocol and set addresses manually.

Since the models FDT224 and 280 have 2 PCBs per unit, set different indoor unit No. and SW on each PCB.

- An outdoor unit No., which is used to identify which outdoor unit and indoor units are connected in a refrigerant system, is set on outdoor unit PCB and indoor unit PCB. Give the same outdoor unit No. to all outdoor unit and indoor units connected in same refrigerant system.
- An indoor unit No. is used to identify individual indoor units. Assign a unique number that is not assigned to any other indoor units on the network.

Unless stated otherwise, the following procedures apply, when new SL is chosen for the communication protocol.

When previous SL is chosen, use figures shown in [] in carrying out these procedures.

Manual address setting Generally applicable to new SL/previous SL, use figures in [] with previous SL.

- ① Address setting of outdoor unit Before turning on the power, set as follows. The outdoor address is registered when the power is turned on.
 - Set **the outdoor No. switches** in a range of **00 – 31 [or 00 – 47 for old SL]**.
Take care not to duplicate with other outdoor unit No. on the network.
 - In the same way also on the master unit of combination**, set the rotary switch for outdoor No. **in a range of 00 - 31 [or 00 – 47 for old SL]**
 - For slave units of combination**, set the rotary switches for outdoor No. at **the same outdoor No. as the master unit of combination**.
 - When 2 units are combined**, set the dip switch SW4-7 of slave unit to **ON**. **When 3 units are combined**, set the dip switch SW4-7 of slave unit 1 to **ON** and the dip switch SW4-8 of slave unit 2 to **ON**. (Use same setting for outdoor No. of master unit and slave unit.)

② Address setting of indoor unit Before turning on the power, set as follows. Indoor address is registered when the power is turned on.

Set **the outdoor No. switch** in a range of **000 – 127 [or 00 – 47 for old SL]**.
 For **the outdoor No switches**, set corresponding outdoor No. in a range of **00 – 31 [or 00 – 47 for old SL]**.
 Set with care not to duplicate with other indoor No. on the network.

Refrigerant system	Outdoor unit	SW1	SW2	SW4-7	Address on network
A	Master	2	2	OFF	22
	Slave	2	2	ON	23
B	Master	2	4	OFF	24
	Slave	2	4	ON	25
C	Master	3	1	OFF	31
	Slave	3	1	ON	00

Refrigerant system	Outdoor unit	SW1	SW2	SW4-7	SW4-8	Address on network
A	Master	2	2	OFF	OFF	22
	Slave 1	2	2	ON	OFF	23
	Slave 2	2	2	OFF	ON	24
B	Master	2	5	OFF	OFF	25
	Slave 1	2	5	ON	OFF	26
	Slave 2	2	5	OFF	ON	27
C	Master	3	1	OFF	OFF	31
	Slave 1	3	1	ON	OFF	00
	Slave 2	3	1	OFF	ON	01

Above list is an example. **The address on the network is master unit +1 for the slave unit.**

If the slave unit address is larger than 31 [or 47 for old SL], the address is assigned sequentially starting from 00.

When setting sequential addresses, take care not to duplicate the master unit address in the refrigerant system B with addresses of slave units in the refrigerant system A.

Note:

Slave unit address is master unit +1. Address of second slave unit is master unit +2. When setting the address for master unit, take care to avoid duplication with other systems. Otherwise, it cannot operate. (Error: E31)

③ Turn on power in order from the outdoor unit to indoor units. Give a one-minute or longer interval for them.
 * When there are some units not supporting new SL connected in the network, set SW5-5 to ON to choose the previous SL communication mode.
 In the case of previous SL, the maximum number of indoor units connectable in a network is 48.

Example of address setting (manual)

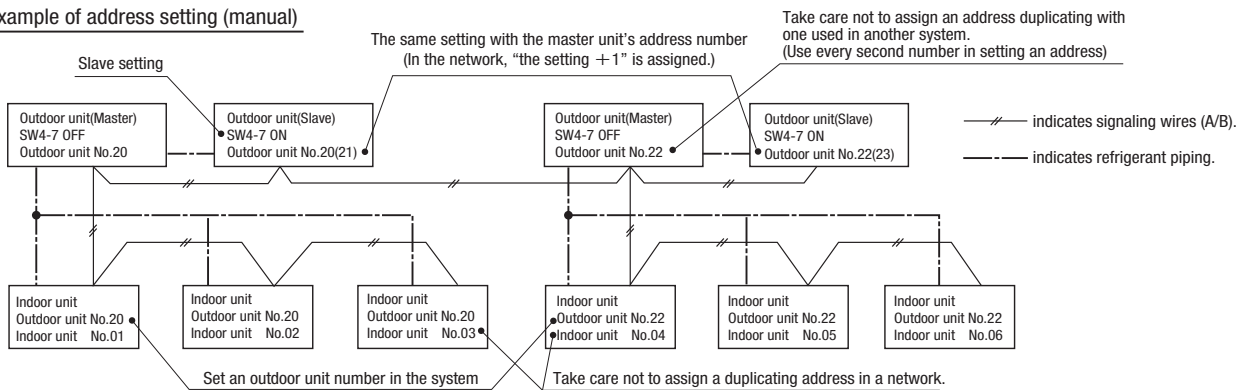

Automatic address setting Generally applicable to new SL/previous SL, use figures in [] with previous SL.

With new SL, you can set indoor unit addresses automatically even for an installation involving multiple refrigerant systems connected with same network, in addition to the conventional automatic address setting of a single refrigerant system installation.
 However, an installation must satisfy some additional requirements such as for wiring methods, so please read this manual carefully before you carry out automatic address setting.

(1) In the case of a single refrigerant system installation (Generally applicable to new SL/previous SL, use figures in [] with previous SL.)

- ① Address setting of outdoor unit Before turning on the power, set as follows.
 Confirm that **the outdoor No. switch** is set at **49 by the default**.
 - **In the same way also on the master unit of combination**, confirm that the rotary switch for outdoor No. is set at **49 by the default**.
 - **In the same way also on the slave unit of combination**, confirm that the rotary switch for outdoor No. is set at **49 by the default**.**When 2 units are combined, set the dip switch SW4-7 of slave unit to ON. When 3 units are combined, set the dip switch 4-7 of slave unit 1 to ON and the dip switch SW4-8 of slave unit 2 to ON.**

Outdoor unit	SW1	SW2	SW4-7	Address on network
Master	4	9	OFF	49
Slave	4	9	ON	00

Outdoor unit	SW1	SW2	SW4-7	SW4-8	Address on network
Master	4	9	OFF	OFF	49
Slave 1	4	9	ON	OFF	00
Slave 2	4	9	OFF	ON	01

CAUTION
 If the slave unit is not specified, a compressor failure may result.

- ② Indoor unit address setting
 Set as follows before you turn on power.
 Make sure that the **Indoor Unit No. switch** is set to **000 [in the case of previous SL: 49] (factory setting)**.
 Make sure that the **Outdoor Unit No. switch** is set to **49 (factory setting)**.
- ③ Turn on power in order from the outdoor unit to indoor units. Give a one-minute or longer interval for them. Unlike the procedure set out in (2) below, you need not change settings from the 7-segment display panel.
- ④ Make sure that the number of indoor units indicated on the 7-segment display panel agrees with the number of the indoor units that are actually connected to the refrigerant system.

(2) In the case of a multiple refrigerant systems installation (Applicable to new SL only. In the case of previous SL, set addresses with some other method.)

(This option is available when the interconnection wiring among refrigerant systems is on the outdoor side and new SL is chosen as the communication protocol.)

Address setting procedure (perform these steps for each outdoor unit)

[STEP1] (Items set before turning on power)

- ① Address setting of outdoor unit Before turning on the power, set as follows.
 Set **the outdoor No. switches** in a range of **00 – 31**.
 Take care not to duplicate with other outdoor unit No. on the network.
In the same way also on the master unit of combination, set the rotary switch for outdoor No. **in a range of 00 - 31**
For slave units of combination, set the rotary switches for outdoor No. at **the same outdoor No. as the master unit of combination**.
When 2 units are combined, set the dip switch SW4-7 of slave unit to ON. When 3 units are combined, set the dip switch SW4-7 of slave unit 1 to ON and the dip switch SW4-8 of slave unit 2 to ON. (Use same setting for outdoor No. of master unit and slave unit.)

- ② Address setting of indoor unit Before turning on the power, set as follows.
 Make sure that the **Indoor Unit No. switch** is set to **000 (factory setting)**.
 Make sure that the **Outdoor Unit No. switch** is set to **49 (factory setting)**.
- ③ Isolate the present refrigerant system from the network.
 Disengage the **network connectors (white 2P)** of the outdoor units. (Turning on power without isolating each refrigerant system will result in erroneous address setting.)

[STEP2] (Power on and automatic address setting)

- ④ Turn on power to the outdoor unit
 Turn on power in order from the outdoor unit to indoor units. Give a one-minute or longer interval for them.
- ⑤ Select and enter "1" in P31 on the 7-segment display panel of each outdoor unit (master unit in case of combination) to input "Automatic address start."
- ⑥ Input a starting address and the number of connected indoor units.
 Input a starting address in P32 on the 7-segment display panel of each outdoor unit (master unit in case of combination).
- ⑦ When a starting address is entered, the display indication will switch back to the "Number of Connected Indoor Units Input" screen.
 Input the number of connected indoor units from the 7-segment display panel of each outdoor unit (master unit in case of combination). Please input the number of connected indoor units (on the same refrigerant line in case of combination) for each outdoor unit. (You can input it from P33 on the 7-segment display panel.)When the number of connected indoor units is entered, the 7-segment display panel indication will switch to "AUX" and start flickering.

[STEP3] (Automatic address setting completion check)

- ⑧ Indoor unit address determination
 When the indoor unit addresses are all set, the 7-segment display panel indication will switch to "AUE" and start flickering.
 If an error is detected in this process, the display will show "A○○."
 Check the 7-segment display panel of each outdoor unit (master unit in case of combination).
 Depending on the number of connected indoor units, it may take **about 10 minutes** before the indoor unit addresses are all set.

[STEP4] (Network definition setting)

- ⑨ Network connection
 When you have confirmed an "AUE" indication on the display of each outdoor unit, **engage the network connectors** again.
- ⑩ Network polarity setting
After you have made sure that the network connectors are engaged, select and enter "1" in P34 on the 7-segment display panel of **any outdoor unit (on only 1 unit : master unit in case of combination)** to specify network polarity.
- ⑪ Network setting completion check
 When the network is defined, "End" will appear on the 7-segment display panel. An "End" indication will go off, when some operation is made from the 7-segment display panel or 3 minutes after.

	STEP1	STEP2	STEP3	STEP4
Indoor unit power source	② OFF	④ ON	—	—
Outdoor unit power source	① OFF	④ ON	—	—
Indoor unit (indoor/outdoor No.SW)	② indoor000/outdoor 49 (factory setting)	—	—	—
Outdoor unit (outdoor No.SW)	① 01,03(Ex)	—	—	—
Network connectors	③ Disconnect(each outdoor unit)	—	—	⑨ Connect(each outdoor unit)
Start automatic address setting	—	⑤ Select "Automatic Address Start" on each outdoor unit.	—	—
Set starting address	—	⑥ outdoor 01: [01] (Ex) outdoor 03: [04] (Ex)	—	—
Set the number of indoor unit	—	⑦ outdoor 01: [03] (Ex) outdoor 03: [03] (Ex)	—	—
Polarity setting	—	—	—	⑩ Set in P34 on the 7-segment display panel of any outdoor unit.
7-segment display	—	⑦ [AUX] (Blink)	⑧ "AUE"(blink), or "A○○" in error events.	⑪ [End]

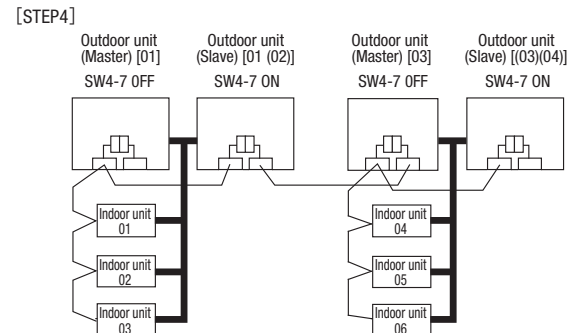
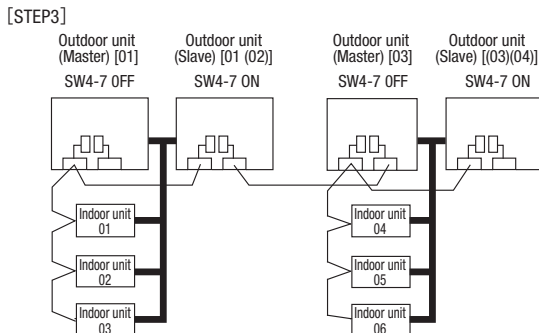
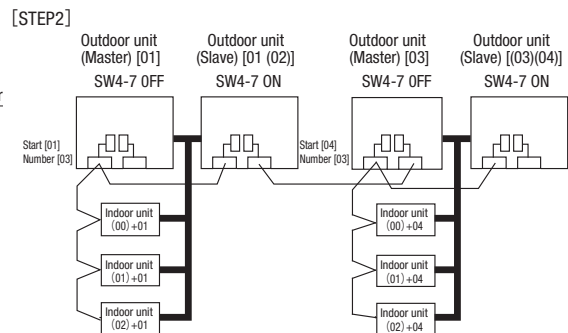
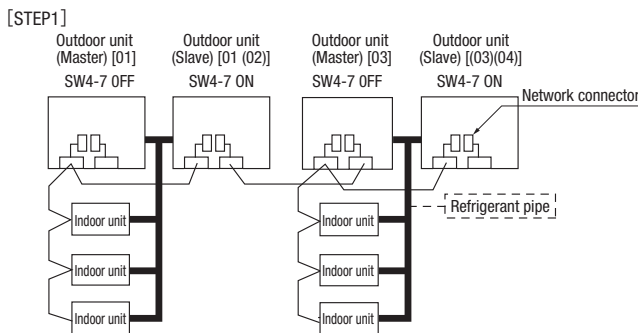

- Within a refrigerant system, indoor units are assigned addresses in the order they are recognized by the outdoor unit. Therefore, they are not necessarily assigned addresses in order from the nearest to the outdoor unit first as depicted in drawings above.
- Make sure that power has been turned on to all indoor units.
- When addresses are set, you can have the registered indoor unit address No. and the outdoor unit address No. displayed on the remote control unit by pressing its CHECK button.
- Automatic address setting can be used for an installation in which plural indoor units are controlled from one remote control unit.
- Once they are registered, addresses are stored in microcomputers, even if power is turned off.
- If you want to change an address after automatic address setting, you can change it from the remote control unit with its "Address Change" function or by means of manual setting. Set a unique address by avoiding the address assigned to other indoor unit on the network when the address is changed.
- Do not turn on power to central control equipment until automatic address setting is completed.
- When addresses are set, be sure to perform a test run and ensure that you can operate all indoor and outdoor units normally. Also check the addresses assigned to the indoor units.

Address change (available only with new SL)

"Address Change" is used, when you want to change an indoor unit address assigned with the "Automatic Address Setting" function from a remote control unit. Accordingly, the conditions that permit an address change from a remote control unit are as follows.











	Indoor unit address setting		Outdoor unit address setting
	Indoor No.SW	Outdoor No.SW	Outdoor No.SW
Automatic address setting for single refrigerant system installation	000	49	49
Automatic address setting for multiple refrigerant systems installation	000	49	00~31

If "CHANGE ADD. ▼" is selected with some addresses falling outside these conditions, the following indication will appear for 3 seconds on the remote control "INVALID OPER".

Operating procedure











When the eco touch remote control is connected, refer to the installation setting in the installation manual which is packed along with the remote control.

(1) When single indoor unit is connected to the remote control.

Item	Operation	Display
1 Address change mode	① Press the AIR CON No. switch for 3 seconds or longer.	[CHANGE ADD. ▼]
	② Each time when you press the  switch, the display indication will be switched.	[CHANGE ADD. ▼] ⇔[MASTER I/U ▲]
	③ Press the SET switch when the display shows "CHANGE ADD. ▼" and then start the address change mode, changing the display indication to the "Indoor Unit No. Setting" screen from the currently assigned address.	[I/U 001 O/U 01] (1sec) →[ SET I/U ADD.] (1sec) →[I/U 001 ] (Blink)
2 To set a new indoor unit No.	④ Set a new indoor unit No. with the  switch. A number indicated on the display will increase or decrease by 1 upon pressing the ▲ or ▼ switch respectively.	[I/U 000 ▲] ⇔[I/U 001 ] ⇔[I/U 002 ] ⇔ ⇔[I/U 127 ▼]
	⑤ After selecting an address, press the SET switch, and then the indoor unit address No. is defined.	[I/U 002] (2sec)
3 To set a new outdoor unit No.	⑥ After showing the defined indoor address No. for 2 seconds, the display will change to the "Outdoor Address No. Setting" screen. The currently assigned address is shown as a default value.	[I/U 002] (2sec Lighting) →[ SET O/U ADD.] (1sec) →[O/U 01 ] (Blink)
	⑦ Set a new outdoor unit No. with the  switch. A number indicated on the display will increase or decrease by 1 upon pressing the ▲ or ▼ switch respectively.	[O/U 00 ▲] ⇔[O/U 01 ] ⇔[O/U 02 ] ⇔ ⇔[O/U 31 ▼]
	⑧ After selecting an address, press the SET switch, and then the outdoor unit No. and the indoor unit No. are defined.	[I/U 002 O/U 02] (2sec Lighting) →[SET COMPLETE] (2sec Lighting) →Returns to normal condition.

(2) When plural indoor units are connected to the remote control.

When plural indoor units are connected, you can change their addresses without altering their cable connection.

Item	Operation	Display
1 Address change mode	① Press the AIR CON Unit No. switch for 3 seconds or longer.	[CHANGE ADD▼]
	② Each time when you press the  switch, the display indication will be switched.	[CHANGE ADD▼] ⇔[MASTER I/U▲]
	③ Press the SET switch when the display shows "CHANGE ADD. ▼" The lowest indoor unit No. among the indoor units connected to the remote control unit will be shown.	[ SELECT I/U] (1sec) →[I/U 001 O/U 01▲] (Blink)
2 Selecting an indoor unit to be changed address	④ Pressing the  switch will change the display indication cyclically to show the unit No.'s of the indoor units connected to the remote control and the unit No.'s of the outdoor units connected with them.	[I/U 001 O/U 01▲] ⇔[I/U 002 O/U 01◆] ⇔[I/U 003 O/U 01◆] ⇔ . . . ⇔[I/U 016 O/U 01▼]
	⑤ Then the address No. of the indoor unit to be changed is determined and the screen switches to the display "  SET I/U ADD."	[ SET I/U ADD.] (1sec) →[I/U 001◆] (Blink)
3 Setting a new indoor unit No.	⑥ Set a new indoor unit No. with the  switch. A number indicated on the display will increase or decrease by 1 upon pressing the ▲ or ▼ switch respectively.	[I/U 000▲] ⇔[I/U 001◆] ⇔[I/U 002◆] ⇔ . . . ⇔[I/U 127▼]
	⑦ After selecting an address, press the SET switch. Then the address No. of the indoor unit is determined.	[I/U 002] (2sec)
4 Setting a new outdoor unit No.	⑧ The display will indicate the determined indoor address No. for 2 seconds and then switch to the "  SET O/U ADD." screen. A default value shown on the display is the current address.	[I/U 002] (2sec lighting) ⇔ [ SET O/U ADD.] (1sec) ⇔ [O/U 01◆] (Blink)
	⑨ Set a new outdoor unit No. with the  switch. A number indicated on the display will increase or decrease by 1 upon pressing the ▲ or ▼ switch respectively.	[O/U 00▲] ⇔[O/U 01◆] ⇔[O/U 02◆] ⇔ . . . ⇔[O/U 31▼]
	⑩ After selecting an address, press the SET switch. Then the address of the indoor unit and outdoor unit are determined.	[I/U 002 O/U 02] (2sec lighting) → [ SELECT] (1sec lighting) → [I/U SELECTION▼] (lighting)
	⑪ If you want to continue to change addresses, return to step ④.	[Press the  switch] (1sec) → [SET COMPLETE] (2~10sec lighting)
5 Ending the session	⑫ If you want to end the session (and reflect new address settings) In Step ⑩, press the ▼ switch to select "END ▲." If you have finished changing addresses, press the SET switch while "END ▲" is shown. While new settings are being transmitted, "SET COMPLETE" will be indicated. Then the remote control display will change to the normal state.	[END▲] → [SET COMPLETE] (2~10sec lighting) → Normal state
	⑬ If you want to end the session (without reflecting new address settings) Before you complete the present address setting session, press the "ON/OFF" switch. Then the display is change to exit from this mode and switch the display to the normal state. All address settings changed in the session will be aborted and not reflected.	[ON/OFF] → Forced termination

The  switch will continuously change the display indication to the next one in every 0.25 seconds when it is pressed for 0.75 seconds or longer.

If the Reset switch is pressed during an operation, the display indication returns to the one that was shown before the last Set switch operation.

Even if an indoor unit No. is changed in this mode, the registered indoor unit No. before address change mode is displayed when [I/U SELECTION▼] is shown.

When "SET COMPLETE" is shown, indoor unit No. is registered.

NOTICE Turn on power to central control equipment after the addresses are determined.
Turning on power in wrong order may result in a failure to recognize addresses.

● 7-segment display indication in automatic address setting

Items that are to be set by the customer

Code	Contents of a display	
P30	Communication protocol 0: Previous SL mode 1: New SL mode	(The communication protocol is displayed ; display only)
P31	Automatic address start	
P32	Input starting address	Specify a starting indoor unit address in automatic address setting.
P33	Input number of connected indoor units	Specify the number of indoor units connected in the refrigerant system in automatic address setting.
P34	Polarity definition 0: Network polarity not defined. 1: Network polarity defined.	

7-segment display indication in automatic address setting.

Code	Contents of a display
AUX	During automatic address setting. X: The number of indoor units recognized by the outdoor unit.
AUE	Indoor unit address setting is completed normally.
End	Polarity is defined. (Automatic address) Completed normally.

Address setting failure indication

Code	Contents of a display	Please check
A01	The number of the indoor units that can be actually communicated with is less than the number specified in P33 on the 7-segment display panel.	Are signal lines connected properly without any loose connections? Input the number of connected indoor units again.
A02	The number of the indoor units that can be actually communicated with is more than the number specified in P33 on the 7-segment display panel.	Are signal lines connected properly without any loose connections? Are the network connectors coupled properly? Input the number of connected indoor units again.
A03	Starting address (P32) + Number of connected indoor units (P33) > 128	Input the starting address again. Input the number of connected indoor units again.
A04	While some units are operating in the previous SL mode on the network, the automatic address setting on multiple refrigerant systems is attempted.	Perform manual address setting. Separate previous SL setting unit from the network Arrange all units to operate in the new SL.

Error indication

Code	Contents of a display	Cause
E31	Duplicating outdoor unit address.	• Plural outdoor units are exist as same address in same network.
E46	Incorrect setting.	• Automatic address setting and manual address setting are mixed.

7-2. Change of control

Contents of control for outdoor unit can be changed with dipswitches on PCB and P $\bigcirc\bigcirc$ on 7-segment indicator.

When changing P $\bigcirc\bigcirc$ on 7-segment indicator, it can be set by holding down SW8 (7-segment indicator UP: Ones digit) and SW7 (Data write/Enter)

Method to change control		Contents of control change
SW setting on PCB	P $\bigcirc\bigcirc$ setting on 7-segment	
SW3-7 to ON*1	Set external input function allocation to "2". *1	Forced cooling/heating mode (It can be fixed at cooling with external input terminals open, or at heating with them closed.)
SW5-1 to ON + SW5-2 to ON	—	Cooling test run
SW5-1 to ON + SW5-2 to OFF	—	Heating test run
Close the fluid operation valve on outdoor unit and set as follows: (1) SW5-2 of PCB to ON (2) SW5-3 of PCB to ON (3) SW5-1 of PCB to ON	—	Pump-down operation
SW5-5	—	Communication method select ON: Previous SL communication, OFF: New SL communication (SLII)
SW6-3	—	High COP combination setting ON: High COP OFF: Standard
J13: Shorted (Factory default), J13: Open	—	External input switing (CnS1, CnS2 only) shorted: Level input, open: Pulse input
J14: Shorted (Factory default), J14: Open	—	Defrost-return temperature shorted: normal, open: Reinforced type
J15: Shorted (Factory default), J15: Open	—	Defrost start temperature shorted : normal, open: Cold weather district.
—	P01	Operation priority select 0: First push preferred (Factory default) 1: Last push preferred
—	P02	Outdoor fan snow protection control 0: Control invalid (Factory default) 1: Control valid
—	P03	Outdoor fan snow protection ON time setting 30 sec (Factory default) 10, 30 to 600 sec
—	P04	Demand ratio change value OFF: Invalid (Factory default) 000, 040, 060, 080 [%]
—	P05	Silent mode setting 0: at shipping-3: Larger values for larger effect
—	P06	Allocation of external output (CnZ1)
—	P07	Allocation of external input (CnS1)
—	P08	Allocation of external input (CnS2)
—	P09	Allocation of external input (CnG1)
—	P10	Allocation of external input (CnG2)
—	P14	2-step demand OFF: Invalid (Factory default) 000, 040, 060, 080 [%]
—	P15	3-step demand OFF: Invalid (Factory default) 000, 040, 060, 080 [%]

*1 When both of external input function assignment (P07 – 10) and SW are changed, the control is changed.

(Ex: When CnS1 is used for the input of forced cooling/cooling mode, set P07 at 2 and SW3-7 to ON. When CnS2 is used for the input of forced cooling/cooling mode, set P08 at 2 and SW3-7 to ON)

By changing the allocation of external input function (P07-10) on the 7-segment, functions of external input terminal may be selected. Inputting signals to external input terminals enable the following functions.

Setting value for external input function assignment	External input terminal shorted	External input terminal open
"0" : External operation input	Permitted	Prohibited
"1" : Demand input	*3	*3
"2" : Cooling / heating force input	Heating	Cooling
"3" : Silent mode 1 *1	Valid	Invalid
"4" : Spare		
"5" : Outdoor fan snow control input	Valid	Invalid
"6" : Test run external input 1 (SW5-1 equivalent)	Test run start	Normal
"7" : Test run external input (SW5-2 equivalent)	Cooling	Heating
"8" : Silent mode 2 *2	Valid	Invalid
"9" : Demand input	*3	*3
"10" : AF periodic inspection display	Valid	Invalid
"11" : AF error display	Valid	Invalid
"12" : Building multi energy save control	Valid	Invalid

*1 Valid/invalid is changed depending on outdoor temperatures.

*2 It is always Valid, regardless of outdoor temperature.

*3 According to the demand setting table.

External output function of CnZ1 can be changed by changing P06 on 7-segment indicator.

"0" : Operation output
"1" : Error output
"2" : Compressor ON output
"3" : Fan ON output
"4 - 9" : Spare

*3 Demand setting table

Demand control	Function assignment 1	Function assignment 9
None (Normal)	Shorted	Shorted
1-step	Open	Shorted
2-step	Open	Open
3-step	Shorted	Open

7-3. External input and output terminals specifications

Name	Purpose (Factory default)	Specification	Operating side connector
External input CnS1	External operation input (Closed at shipping)	Non-voltage contactor (DC12V)	J. S. T (NICHATSU) B02B-XAMK-1 (LF) (SN)
External input CnS2	Demand input (Short-circuited at shipping)	Non-voltage contactor (DC12V)	J. S. T (NICHATSU) B02B-XARK-1 (LF) (SN)
External input CnG1	Cooling / Heating forced input (Open at shipping)	Non-voltage contactor (DC12V)	J. S. T (NICHATSU) B02B-XAEK-1 (LF) (SN)
External input CnG2	Silencing mode input (Open at shipping)	Non-voltage contactor (DC12V)	J. S. T (NICHATSU) B02B-XASK-1 (LF) (SN)
External output CnH	Operation output	DC12V output	MOLEX 5286-02A-BU
External output CnY	Error output	DC12V output	MOLEX 5266-02A

7-4. Installation of indoor unit at the downstream of branching control

When installing more than one indoor unit at the downstream from a branching control, set it such a manner that all of them will be operated in the same cooling/heating mode, by either one of the following methods.

(1) Control of more than one indoor unit with one remote control unit

All indoor units can be controlled in the same ON/OFF, cooling/heating mode, set temperature, etc. with one remote control.

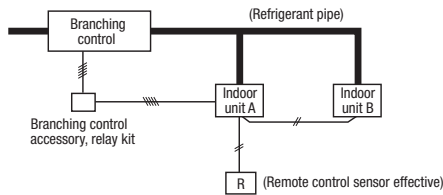

- Connect one remote control to all indoor units at the downstream.
- Turn the remote control sensor to ON.
- When connecting the central control; Implement the method of (2) Same cooling/heating control in master/slave indoor unit.
- It is prohibited to operate the unit without using the remote control.

(2) Same cooling/heating control in master/slave indoor unit

Those other than the cooling/heating mode can be controlled individually with the remote control which is connected to each indoor unit. Cooling/heating mode can be set from the remote control of the indoor unit to which the branching control accessory relay kit is connected.

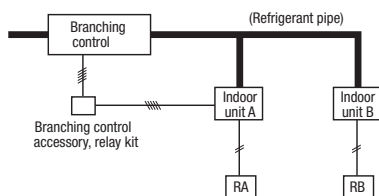

- Install one remote control for each indoor unit at the downstream.
- Set the address of the indoor unit (= Master indoor unit: Indoor unit A), which is connected to the relay kit, for all indoor unit (= slave indoor unit: Indoor unit B) to which the branching control accessory relay kit is not connected, by operating the remote control as described below.
- No particular setting is required for the master indoor unit.

Item	Operation	Display
1 Address change mode	① Press the AIR CON No. switch on the remote control (RB) of slave indoor unit for more than 3 seconds.	[CHANGE ADD. ▼]
	② Each time when you press the ◀ switch, the display indication will be switched.	[CHANGE ADD. ▼] ⇔[MASTER I/U▲]
	③ Press the SET switch when "⇔[MASTER I/U▲]" is displayed. This puts it in the address mode, and the master indoor unit No. setting screen is displayed.	→[I/U 001 ◆] (Blink)
2 To set a new indoor unit No.	④ Set a new indoor unit No. with the ◆ switch. A number indicated on the display will increase or decrease by 1 upon pressing the ▲ or ▼ switch respectively.	[I/U 000▲] ⇔[I/U 001 ◆] ⇔[I/U 002 ◆] ⇔ ... ⇔[I/U 127▼]
	⑤ After selecting an address, press the SET switch, and then the indoor unit address No. is defined.	[I/U 002] (2sec Lighting) →[SET COMPLETE] (2sec Lighting) →Returns to normal condition.

The ◆ switch will continuously change the display indication to the next one in every 0.25 seconds when it is pressed for 0.75 seconds or longer. If the Reset switch is pressed during an operation, the display indication returns to the one that was shown before the last Set switch operation.

< Caution >

- (a) This control is effective only when the units are stopped.
- (b) If you press the MODE CHANGE switch on the remote control of the indoor unit for which the master indoor unit No. has been specified with this control, a message "INVALID OPER" is displayed for 3 seconds and then it returns to the original state.
- (c) Error code display:

Code	Cause
E11	In case when more that 2 indoor units have been connected to the remote control for which the address has been set.
E18	When the set master indoor unit No. does not exist in the same SL network Or, when the address, which had already been set for a slave indoor unit, is set as the master indoor unit No.

8. TEST OPERATION AND TRANSFER

8-1. Before starting operation

- (1) **Make sure that a measurement between the power source terminal block and ground, when measured with a 500V megger, is greater than 1 MΩ.**
When the unit is left for a long time with power OFF or just after the installation, there is possibility that the refrigerant is accumulated in the compressor and the insulation resistance between the contact terminals for power source and grounding decreases to 1MΩ or around.
When the insulation resistance is 1MΩ or more, the insulation resistance will rise with crank case heater power ON for 6 hours or more because the refrigerant in the compressor is evaporated.
- (2) Please check the resistance of the signaling wire terminal block before power is turned on. If a resistance measurement is 100Ω or less, it suggests a possibility that power cables are connected to the signaling wire terminal block. (Please refer to 6-3. Standard resistance value.)
- (3) **Be sure to turn on the crank case heater 6 hours before operation.**
- (4) **Make sure that the bottom of the compressor casing is warm.** (higher than outdoor temperature +5°C)
- (5) Be sure to fully open the service valves (liquid, gas and Equalizer oil piping (for a combined installation only)) for the outdoor unit.
Operating the outdoor unit with the valves closed may damage the compressor.
- (6) **Check that the power to all indoor units has been turned on. If not, water leakage may occur.**

CAUTION

Please make sure that the service valves (gas, liquid, oil equalizing pipe (for a combined installation only)) are full open before a test run. Conducting a test run with any of them in a closed position can result in a compressor failure.

8-2. Check operation

It is recommended to practice the check operation in precedent to the test run.

[Even if the check operation is not practiced, the test run and normal operations can be performed.]

For further details regarding the check operation refer to the technical data.

Important

- Practice the check operation after completing the address setting for the indoor and outdoor units and also after charging the refrigerant.
- To assure accurate checking, proper amount of refrigerant must be retained.
- Check operation cannot be done when the system is stopped by an error.
- Check operation cannot be done when the total capacity of connected indoor units is less than 80% of the outdoor unit capacity.
- Check operation cannot be done when the system communication method is previous SL.
- Don't perform the check operation simultaneously on more than one refrigerant line. Accurate checking cannot be obtained.
- Practice the check operation within the operation temperature ranges (Outdoor temperature: 0 – 43°C, room temperature: 10 – 32°C). Check operation will not start out of these ranges.
- Outdoor air processing unit cannot be checked. (It is possible to check indoor units other than the outdoor air processing unit of the same refrigerant line.)

(1) Check items

Check operation allows proving the following points.

- Whether or not the service valve is left open (Service valve open/close check). (In case of combination, however, all service valves need to be closed on master and slave units to obtain accurate judgment.)
- Whether or not the refrigerant pipes and signal cables are connected properly between indoor and outdoor units. (Mismatch check)
- Whether or not the indoor expansion valve operates properly. (Expansion valve failure check)

(2) Method of check operation

(a) Starting the check operation

- Confirm that all of the following switches are turned OFF: SW3-2 (Auto backup operation), SW3-6 (Pipe wash mode), SW3-7 (Forced cooling/heating mode), SW5-1 (Test run), SW5-2 (Test run cooling setting), SW5-3 (Pump-down operation) and SW5-6, -7, -8 (Capacity measurement mode). (In case of combination, on both main and slave units)
- At the next, turn the SW3-5 (Check operation) OFF → ON (only on master unit in case of combination) so that the check operation will start.
- It takes 15 – 30 minutes normally (max. 80 min) from the start to the end of check operation.

(b) End the check operation and the result display

- When the check operation is over, the system stops automatically. The 7-segment indicator shows the result (only on master unit in case of combination).

<Normal ending>

- 7-segment indicator shows "CHO End".
- Return the SW3-5 to OFF. The 7-segment indicator returns to normal display.

<Abnormal ending>

- 7-segment indicator shows an error alarm.
- Referring to the section [Inspect here], repair the faulty section and return the SW3-5 to OFF.
- At the next, repeat the check operation from the Step (2) above.

Display on 7-segment indicator during check operation

Code indicator	Data indicator	Display contents
H1	Max. remaining time	Check operation preparation on. Indicates max. remaining time (min). (In case of combination, indicated on master unit only.)
H2	Max. remaining time	Check operation on. Indicates max. remaining time (min). (In case of combination, indicated on master unit only.)
CHO	End	Normal ending of check operation. (In case of combination, indicated on master unit only.)

Error display on 7-segment indicator after ending the check operation

Code indicato	Data indicator	Display contents	Check following points
CHL	---	Operation valve is closed. (Refrigerant circuit is shut off partially.)	<ul style="list-style-type: none"> • Isn't the service valve of outdoor unit left open? • Is the low pressure sensor normal? (Detected pressure can be seen on the 7-segment indicator.) • Is the connector of indoor unit expansion valve coil connected? • Isn't the indoor unit expansion valve coil disconnected from the expansion valve body? • Is the indoor unit heat exchanger sensor normal? (Check if the sensor is disconnected.)
CHU	Abnormal indoor unit No.	Mismatch between refrigerant pipes and signal cables. Refrigerant is not circulated to the indoor unit of which No. is displayed.	<ul style="list-style-type: none"> • Are the refrigerant pipes and signal cables connected properly between the indoor and outdoor units? • Is the connector of indoor unit expansion valve coil connected? • Isn't the indoor unit expansion valve coil disconnected from the expansion valve body? • Is the indoor unit heat exchanger sensor normal? (Check if the sensor is disconnected.)
CHJ	Abnormal indoor unit No.	Expansion valve on the indoor unit of which No. is displayed is not operating properly.	<ul style="list-style-type: none"> • Is the connector of indoor unit expansion valve coil connected? • Isn't the indoor unit expansion valve coil disconnected from the expansion valve body? • Is the indoor unit heat exchanger sensor normal? (Check if the sensor is disconnected.)
CHE	---	Abnormal ending of check operation.	<ul style="list-style-type: none"> • Isn't any error displayed (E??) on the indoor unit or outdoor unit? • Are signal cables connected without play? • Hasn't the SW setting been changed during the check operation?

※ When any error is detected, errors other than those listed above may be displayed. In such occasion, refer to the separate technical data.

8-3. Test operation**(1) Test run from an outdoor unit.**

Whether external inputs are set to ON or OFF, you can start a test run by using the SW5-1 and SW5-2 switches provided on the outdoor unit board.

Select the test run mode first.

Please set SW5-2 to ON for a cooling test run or OFF for a heating test run. (It is set to OFF at the factory for shipment)

Turning SW5-1 from OFF to ON next will cause all connected indoor units to start.

When a test run is completed, please set SW5-1 to OFF.

Note: During a test run, an indoor unit cannot be operated from the remote control unit (to change settings). ("Under central control" is indicated)

(2) Method of starting a test run for a cooling operation from an outdoor unit: please operate a remote control unit according to the following steps.**(a) Start of a cooling test run**

○ Operate the unit by pressing the **START/STOP** button.

○ Select the "COOLING" mode with the **MODE** button.

○ Press the **TEST RUN** button for 3 seconds or longer.

The screen display will be switched from "Select with ITEM◆" → "Determine with SET" → "Cooling test run▼."

○ When the **SET** button is pressed while "Cooling test run▼" is displayed, a cooling test run will start. The screen display will be switched to "COOLING TEST RUN."

(b) Termination of a cooling test run

○ When the **START/STOP** button or the "TEMP SET button is pressed, a cooling test run will be terminated.

Notes : for engineers undertaking piping or electrical installation work

When a test run is completed, please make sure again that the electrical component box cover and the main body panel have been attached before you turn the unit over to the customer.

8-4. TRANSFER

○ Use the instruction manual that came with the outdoor unit to explain the operation method to the customer.

Please ask the customer to keep this installation manual together with the operation manual of his indoor units.

○ Instruct the customer that the power should not be turned off even if the unit is not to be used for a long time. This will enable operation of the air-conditioner any time.

(Since the compressor bottom is warmed by the crank case heater, seasonal compressor trouble can be prevented.)

9. CAUTIONS FOR SERVICING (for R410A and compatible machines)

(1) To avoid mixing of different types of oil, use separate tools for each type of refrigerant.

(2) To avoid moisture from being absorbed by the refrigerant oil, the time for when the refrigerant circuit is open should be kept as short as possible. (Within 10 min. is ideal.)

(3) For other piping work, airtightness testing, vacuuming, and refrigerant charging, refer to section 3, Refrigerant piping.

(4) Diagnostic Inspection Procedures

For the meanings of failure diagnosis messages, please refer to the nameplate provided on the unit (on the back of the control lid)

(5) 7-segment LED indication

Data are indicated when so chosen with the indication selector switch. For the details of indication, please refer to the cable name plate attached on the unit. (On the face of the control lid)

(6) Internal wiring

After maintenance, all wiring, wiring ties and the like, should be returned to their original state and wiring route, and the necessary clearance from all metal parts should be secured.

5.2 Instructions for installing the branch pipe set

PSC012D093C

- ⊙ This manual describes the specifications of branching pipe set installation. For outdoor unit installation and indoor unit installation, please refer to the respective installation manuals supplied with your outdoor unit and indoor unit.
- ⊙ Before you set about installation work, please read this manual carefully so that you can carry out installation work according to the instructions contained herein.
- Please read the safety instructions contained in the installation manual supplied with your outdoor unit carefully and carry out installation work unerringly.
- When installation work is completed, conduct a test run to check the installation for any anomaly. Please also give the customer necessary instructions as to the operation and maintenance of the unit pursuant to the instruction manual (supplied with the indoor unit).
- Please ask the customer to keep the installation manual on the customer's part together with the instruction manual.

PARTS LIST

Branching pipe set type	Suction gas side	Discharge gas side	Liquid side
DIS-22-1-RG			
DIS-180-1-RG			
DIS-371-2-RG			
DIS-540-2-RG			
DOS-2A-3-R			
DOS-3A-3-R			

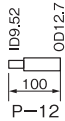
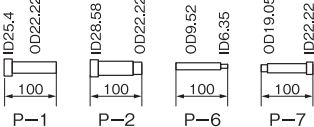
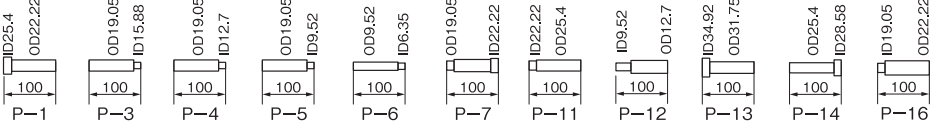
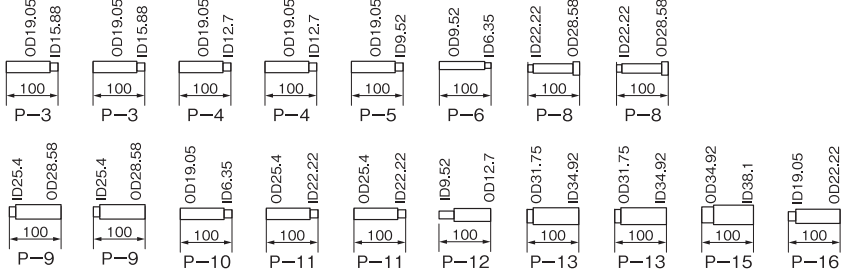
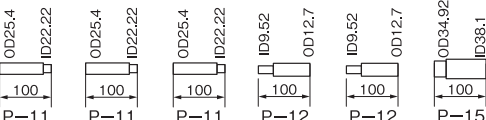
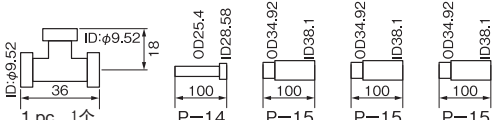
Branching pipe set type	Different diameter pipe joint
DIS-22-1-RG	
DIS-180-1-RG	
DIS-371-2-RG	
DIS-540-2-RG	
DOS-2A-3-R	
DOS-3A-3-R	

INSTALLATION PROCEDURE

1. Please select an appropriate branching pipe set model and a pipe size by consulting with the installation manual of the indoor unit or other relevant technical documents.

Attention

- ① When connecting an indoor unit to the branching pipe located most downstream via a branching control, keep the pipe size specified for the indoor unit all the way up to the branching pipe. Match the pipe size to the indoor unit capacity for the section of discharge gas piping connecting the branching pipe with the branching control.
- ② Use a pipe conforming to a pipe size specified for indoor unit connection for the section between an indoor unit and a branching pipe.
- ③ Use a pipe conforming to a pipe size specified for outdoor unit connection for the section between an outdoor branching pipe and an outdoor unit.

2. Cut a branching pipe set or a different diameter joint with a pipe cutter to make it fit for a selected pipe size before application.

Attention

- ① In cutting pipes, always use a pipe cutter. Remove burrs from a cut end when you cut a pipe. In doing so, keep a cut end downward so that no chips or burrs may enter the pipe.
- ② Take utmost care so that no foreign matter such as dust or water may enter piping during installation work.
 - Please cover all the open ends of piping until installation work is completed. Particularly, any openings in the section of piping laid outdoors should be sealed stringently.
 - As long as possible, avoid open ends left facing upward. Make them face either horizontally or downward.
- ③ A branching joint (for suction gas, discharge gas and liquid) must always be positioned in such a way that it branches either horizontally or vertically (in the case of model type DIS), only vertically (in the case of model type DOS).

Use pipe cutter to cut pipes.

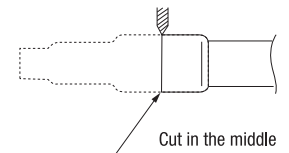

• In the case of a branching pipe set (model type DIS)

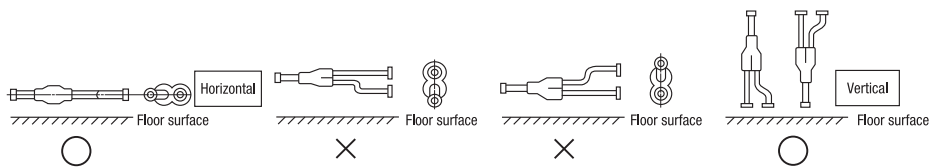

• In the case of a branching pipe set (model type DOS)

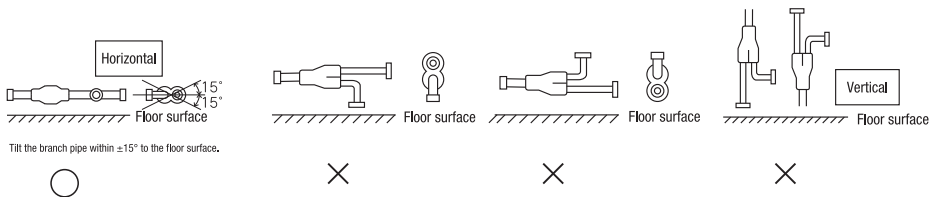

④ When using the branch pipe set, make sure to secure a straight section of 500 mm or more for both the gas and liquid pipes before branching them.

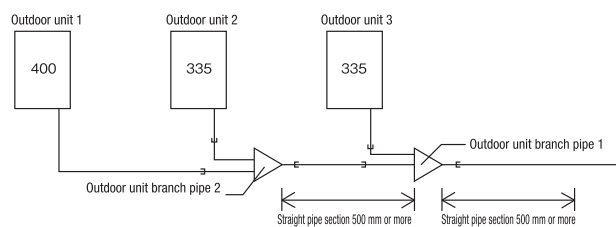

⑤ Always apply nitrogen gas when soldering joints. If nitrogen gas is not applied, a large amount of film oxide will be formed which could lead to a critical failure in the unit. Use caution to prevent moisture or any foreign matters from entering the pipe when connecting pipe ends.

For the method of air tightness testing and pulling air, please refer to the installation manual of the outdoor unit.

⑥ Do not leave piping with any open ends uncovered to prevent water or foreign matters from entering inside.

3. Please dress it with an attached insulation sheet for heat insulation. (Heat-insulate suction gas, discharge gas and liquid pipes)

Attention

- ① Apply an attached insulation sheet along a pipe, tape the joining line with a joint tape (to be procured on the installer's part) for complete sealing, and wrap the pipe and insulation sheet entirely with a tape.
- ② Dress suction gas, discharge gas and liquid pipes with attached insulation sheets for heat insulation.
- ③ Ensure that the liquid pipe is given the heat insulation as good as that of the gas pipe. The absence of heat insulation can cause dripping water from dew condensing on the pipe or performance degradation.

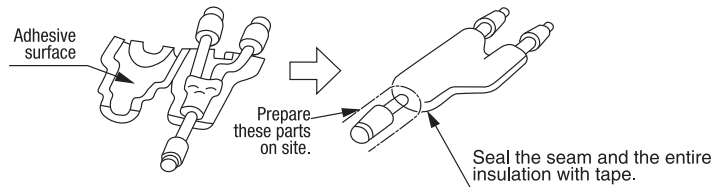

4. How to select a branching pipe

How to select a branching pipe set

- An appropriate branching pipe size varies depending on the capacity of connected indoor units (combined total capacity connected downstream), so please choose from the table below. Applicable branching pipe set models differ depending on whether the installation point is located in the upstream or downstream of a branching control, so please select the correct one according to the following instructions.

(1) In the upstream of a branching control

Total capacity downstream	Branching pipe set model type
less than 180	DIS-22-1-RG
180 or higher – less than 371	DIS-180-1-RG
371 or higher – less than 540	DIS-371-2-RG
540 or more	DIS-540-2-RG

(2) In the downstream of a branching control

Total capacity downstream /	Branching pipe set model type
less than 180	DIS-22-1G
180 or higher – less than 371	DIS-180-1G
371 or higher – less than 540	DIS-371-1G
540 or more	DIS-540-2G

Attention

- ① When connecting an indoor unit to the branching pipe located most downstream via a branching control, keep the pipe size specified for the indoor unit all the way up to the branching pipe. Match the pipe size to the indoor unit capacity for the section of discharge gas piping connecting the branching pipe with the branching control.
- ② Use a pipe conforming to a pipe size specified for indoor unit connection for the section between an indoor unit and an indoor unit side branching pipe.
- ③ A branching joint (for suction gas, discharge gas and liquid) must always be positioned in such a way that it branches either horizontally or vertically.

5. Example of piping

Connected capacity:294

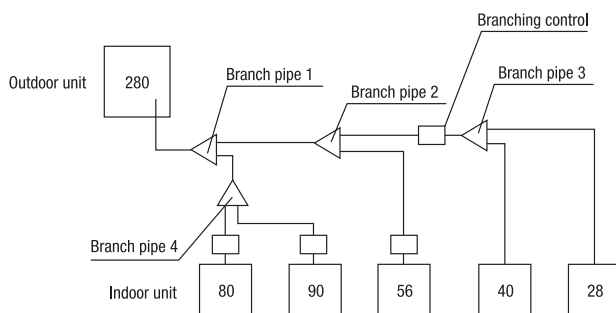

Selection of a branching pipe set

Mark	Selection procedure	Branching pipe set model type
Branch pipe 1	Combined total capacity of indoor units connected downstream $(80+90+56+40+28)=294$	DIS-180-1-RG
Branch pipe 2	Combined total capacity of indoor units connected downstream $(56+40+28)=124$	DIS-22-1-RG
Branch pipe 3	Combined total capacity of indoor units connected downstream $(40+28)=68$	DIS-22-1G
Branch pipe 4	Combined total capacity of indoor units connected downstream $(80+90)=170$	DIS-22-1-RG

5.3 Branching control installation guide

PCB012D067

Indoor units are the same with those of Inverter Multi specifications.
Please lay refrigerant piping, electrical cables (including signal wires) and operate units according to this installation guide, indoor and outdoor unit installation manuals.

Precautions for safety

- Read the "SAFETY PRECAUTIONS" carefully first of all and then strictly follow it during the installation work in order to protect yourself.
- The precautionary items mentioned below are distinguished into two levels, **⚠ WARNING** and **⚠ CAUTION**.
⚠ WARNING: Wrong installation would cause serious consequences such as injuries or death.
⚠ CAUTION: Wrong installation might cause serious consequences depending on circumstances.
 Both mentions the important items to protect your health and safety so strictly follow them by any means.
- After completing the installation, do commissioning to confirm there are no abnormalities, and explain to the customers about "SAFETY PRECAUTIONS", correct operation method and maintenance method (air filter cleaning, operation method and temperature setting method) with user's manual of this unit.
- Ask your customers to keep this installation manual together with the user's manual. Also, ask them to hand over the user's manual to the new user when the owner is changed.

⚠ WARNING	
● Installation should be performed by the specialist. If you install the unit by yourself, it may lead to serious trouble such as water leakage, electric shock, fire, and injury due to overturn of the unit.	⚠
● Install the system correctly according to these installation manuals. Improper installation may cause explosion, injury, water leakage, electric shock, and fire.	⚠
● Consider measurement not to exceed the limit of the density of refrigerant in the event of leakage especially when it is installed in a small room. Consult the specialist about the measure. If the density of refrigerant exceeds the limit in the event of the leakage, serious accidents may occur due to lack of oxygen.	⚠
● Use the genuine accessories and the specified parts for installation. If parts unspecified by our company are used it could cause water leakage, electric shock, fire, and injury due to overturn of the unit.	⚠
● Ventilate the working area well in case the refrigerant leaks during installation. If the refrigerant contacts the fire, toxic gas is produced.	⚠
● Install the unit in a location that can hold heavy weight. Improper installation may cause the unit to fall leading to accidents.	⚠
● Install the unit properly in order to be able to withstand strong winds such as typhoons, and earthquakes. Improper installation may cause the unit to fall leading to accidents.	⚠
● Do not mix air in to the cooling cycle on installation or removal of the air-conditioner. If air is mixed in, the pressure in the cooling cycle will rise abnormally and may cause explosion and injuries.	⚠
● Be sure to have the electrical wiring work done by qualified electrical installer, and use exclusive circuit. Power source with insufficient capacity and improper work can cause electric shock and fire.	⚠
● Use specified wire for electrical wiring, fasten the wiring to the terminal securely, and hold the cable securely in order not to apply unexpected stress on the terminal. Loose connections or hold could result in abnormal heat generation or fire.	⚠
● Check for refrigerant gas leakage after installation is completed. If the refrigerant gas leaks into the house and comes in contact with a fan heater, a stove, or an oven, toxic gas is produced.	⚠
● Use the specified pipe, flare nut, and tools for R410A. Using existing parts (R22) could cause the unit failure and serious accident due to explosion of the cooling cycle.	⚠
● Tighten the flare nut according to the specified method by with torque wrench. If the flare nut were tightened with excess torque, it could cause burst and refrigerant leakage after a long period.	⚠
● Connect the pipes for refrigeration circuit securely in installation work before compressor is operated. If the compressor is operated when the service valve is open without connecting the pipe, it could cause explosion and injuries due to abnormal high pressure in the system.	⚠
● Stop the compressor before removing the pipe on pump down work. If the pipe is removed when the compressor is in operation with the service valve open, air would be mixed in the refrigeration circuit and it could cause explosion and injuries due to abnormal high pressure in the cooling cycle.	⚠
● Use the genuine option parts. And installation should be performed by a specialist. If you install the unit by yourself, it could cause water leakage, electric shock and fire.	⚠
● Do not repair by yourself. And consult with the dealer about repair. Improper repair may cause water leakage, electric shock or fire.	⚠
● Consult the dealer or a specialist about removal of the air conditioner. Improper installation may cause water leakage, electric shock or fire.	⚠
● Turn off the power source during servicing or inspection work. If the power is supplied during servicing or inspection work, it could cause electric shock and injury by the operating fan.	⚠
● Do not run the unit when the panel or protection guard are taken off. Touching the rotating equipment, hot surface, or high voltage section could cause an injury to be caught in the machine, to get burned, or electric shock.	⚠
● Shut off the power before electrical wiring work. It could cause electric shock, unit failure and improper running.	⚠

⚠ CAUTION	
● Perform earth wiring surely. Do not connect the earth wiring to the gas pipe, water pipe, lightning rod and telephone earth wiring. Improper earth could cause unit failure and electric shock due to a short circuit. Never connect the grounding wire to a gas pipe because if gas leaks, it could cause explosion or ignition.	⚠
● Do not install the indoor unit near the location where there is possibility of flammable gas leakages. If the gas leaks and gathers around the unit, it could cause fire.	⚠
● Do not install and use the unit where corrosive gas (such as sulfuric acid gas etc.) or flammable gas (such as thinner, petroleum etc.) may be generated or accumulated, or volatile flammable substances are handled. It could cause the corrosion of heat exchanger, breakage of plastic parts etc. And inflammable gas could cause fire.	⚠
● Do not use the indoor unit at the place where water splashes such as laundry. Indoor unit is not waterproof. It could cause electric shock and fire.	⚠
● Do not use the indoor unit for a special purpose such as food storage, cooling for precision instrument, preservation of animals, plants, and a work of art. It could cause the damage of the items.	⚠
● Do not install nor use the system near equipments which generate electromagnetic wave or high harmonics. Equipments like inverter equipment, private power generator, high-frequency medical equipment, or telecommunication equipment might influence the air conditioner and cause a malfunction and breakdown. Or the air conditioner might influence medical equipments or telecommunication equipments, and obstruct their medical activity or cause jamming.	⚠
● Do not install the indoor unit at the place listed below. - Places where flammable gas could leak. - Places where carbon fiber, mist powder or any powder is floated. - Place where the substances which affect the air conditioner are generated such as sulfide gas, chloride gas, acid or alkali. - Places exposed to oil mist or steam directly. - On vehicles and ships. - Places where machinery which generates high harmonics is used. - Places where cosmetics or special sprays are frequently used. - Highly salted area such as beach. - Heavy snow area. - Places where the system is affected by smoke from a chimney. - Altitude over 1000m	⚠
● Do not use the base frame for the outdoor unit which is corroded or damaged after a long period of use. It could cause the unit falling down and injury.	⚠
● Pay attention not to damage the drain pan by weld sputter when brazing work is done near the unit. If sputter entered into the unit during brazing work, it could cause damage (pinhole) of drain pan and leakage of water. To avoid damaging, keep the indoor unit packed or cover the indoor unit.	⚠
● Ensure the insulation on the pipes for refrigeration circuit so as not to condense water. Incomplete insulation could cause condensation and it would wet ceiling, floor, and any other valuables.	⚠
● Pay extra attention, carrying the unit by hand. Carry the unit with 2 people if it is heavier than 20kg. Do not use the plastic straps but the grabbing place, moving the unit by hand. Use protective gloves in order to avoid injury by the aluminum fin.	⚠
● Make sure to dispose of the packaging material. Leaving the materials may cause injury as metals like nail and woods are used in the package.	⚠
● Do not touch the refrigerant piping with bare hands when in operation. The pipe during operation would become very hot or cold according to the operating condition, and it could cause a burn or frostbite.	⚠
● Do not clean up the air-conditioner with water. It could cause electric shock.	⚠
● Do not turn off the power source immediately after stopping the operation. Be sure to wait for more than 5 minutes. Otherwise it could cause water leakage or breakdown.	⚠

1. BEFORE BEGINNING INSTALLATION

① Limitation on the number of branching controls which can be connected to a outdoor unit is as follows.

Outdoor unit	Minimum number of units to be able to connect
- 280	2 units
- 560	4 units
- 850	6 units
- 1130	8 units
- 1680	10 units

※For PFD112X4-E model, calculate the number of units taking 1 branching control as 4 controls in this limit.











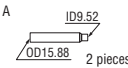
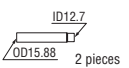
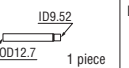



② The combined total capacity and the number of indoor units connected in the downstream of a branching control are subject to restrictions depicted in the table below.

Branching control model type	Total capacity downstream	Number of connectable units
PFD112	Less than 112	1 - 5
PFD180	112 or more but less than 180	1 - 8
PFD280	180 or more but 280 or less	1 - 10

※When installing more than one indoor unit at the downstream from a branching control, set it such a manner that all of them will be operated in the same cooling/heating mode, by either one of the following methods.

- Control of more than one indoor unit with one remote control unit
- Same cooling/heating control in master/slave indoor unit (Refer to the installation manual of outdoor unit.)

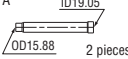
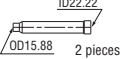
③ Make sure that no accessory is missing.

Branching control model type	Different diameter pipe joint				Heat insulation material	Relay kit	Signal wire	Tube, insulation	Band
	For outdoor unit gas suction pipe For indoor unit gas pipe		For outdoor unit gas discharge pipe						
PFD112	A 	B 	C 	D 					
PFD180	None	None	None	None					
PFD280	A 	B 	C 	None	3 pieces	1 piece	1 piece	1 piece	2 pieces

2. INSTALLATION OF A BRANCHING CONTROL

① Selecting the installation location

- A branching control sometimes generates noises during control operations whether the system is in operation or stands still. When it is installed in a place with a low background noise level, please take appropriate precautions such as installing it away from the indoor unit.
- The position where you can install refrigerant pipes within the specified restrictions on length.
- The position where you can install hanger bolts and secure a required level of strength. (The position where pulling force of 20 kg per bolt is endured)
- The position where a service space conforming to the requirements shown in the drawing on the right can be secured.

PLEASE NOTE

- (1) Do not fail to provide an inspection port at the specified position.
- (2) A branching control cannot be installed upside down. Please install it in such a manner that the main body is held levelly.

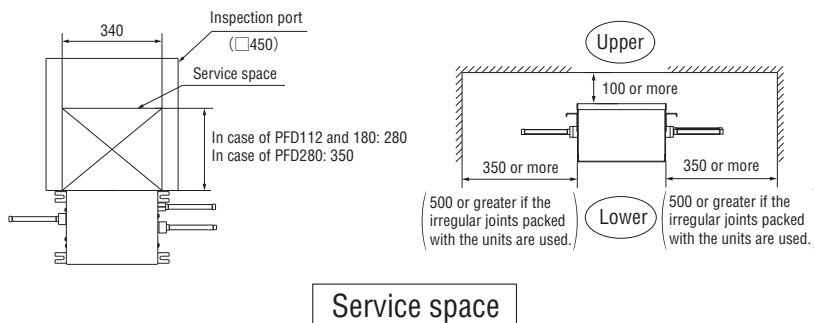

② The positions of hanger bolts.

Use four M10 bolts for the hanging bolts. (To be procured from a local supplier)
Please fasten securely as illustrated in the drawing on the right.

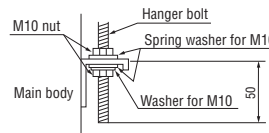

③ Cautions when carrying a unit.

- In carrying the unit, please hold it by the hooks. Holding pipes can result in pipe deformation and a unit failure.
- Do not put your hand in the notch area for fear that you should get hurt.
- Since the unit is heavy, take care in handling it.

When you install the main body, but you cannot position it properly to the opening of the ceiling, please adjust the position by moving it along a fixing metal's oblong hole.



3. REFRIGERANT PIPING

- A branching control has on its main body beneath the connection ports such indications as “S.G (OUT),” “D.G (OUT)” and “G (IN)” provided for the outdoor unit gas suction pipe, the outdoor unit gas discharge pipe and indoor unit gas pipes respectively, **so please make sure that you connect correct pipes to correct ports.**
- No liquid pipe needs to be connected to a branching control.
- A unit must not be operated or left for a long time without completing the connection of individual branching controls and indoor units.
- Pipes are to be brazed to connect to a branching control.
- When brazing work, perform it while cool down around the brazing port with wet towels to prevent the overheating.
- After check the gas leak test, install the heat insulation (prepare on site) to the brazing port of the indoor unit.

① Pipe connection.

When the diameter of the pipe on a branching control is different from that of the connection pipe, use a different-diameter pipe joint supplied as an accessory.

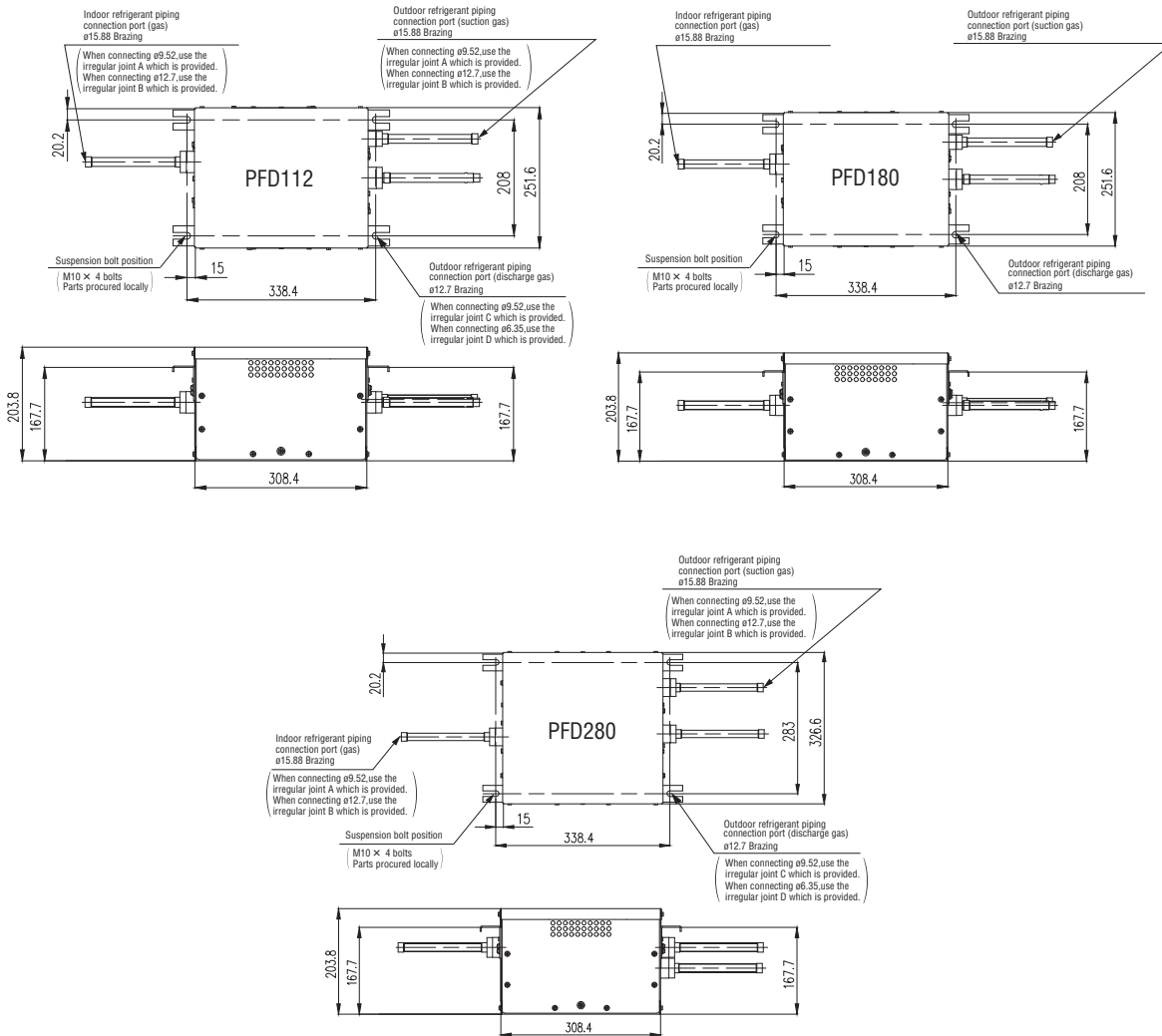

② Heat insulation of pipes

- Do not fail to dress with a pipe cover supplied as an accessory for heat insulation.

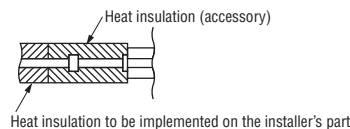

4. ELECTRICAL WIRING WORK

- Please implement cabling according to the instructions contained in the drawing below.

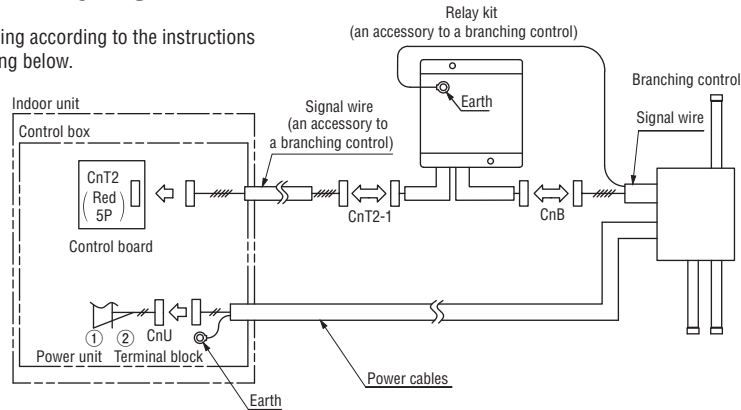

- Appearance drawing of a relay kit

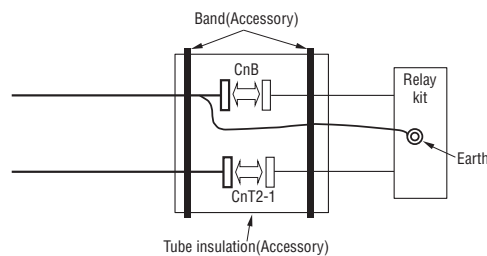
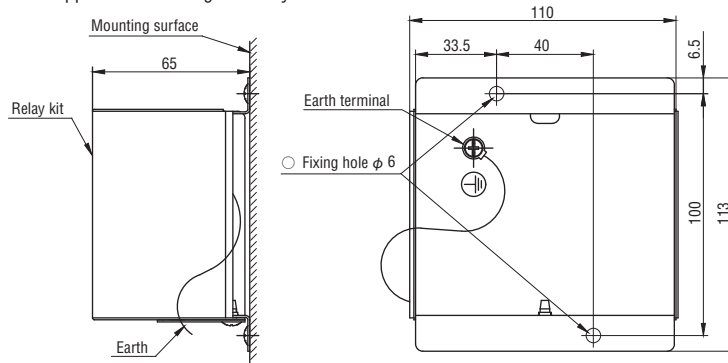

PLEASE NOTE

- (1) Do not extend the signal wire between an indoor unit and a relay kit beyond a 2 m cable supplied as an accessory.
- (2) To extend the signal cables connecting between a relay kit and branching control and a power cable connecting between an indoor unit and a branching control, please use the cables specified below. In extending these cables, make sure that the consistency of cable colors is maintained. (When you extend signal and power cables, do not forget to extend a grounding wire accordingly as well.)

Signal wire	2.0/2.0 (mm ²) × 5 (pieces)
Power wire	2.0/2.0 (mm ²) × 2 (pieces)

- (3) Please connect the earth wire from a branching control to an indoor unit and relay kit.
- (4) When connect the earth to a relay kit, please note below.
 - Please attach the earth connector to the orientation shown in the figure, that the earth wire does not come to a fixed surface of a relay kit.
 - Please giving a margin to the wiring, that does not come into contact with the sheet metal edge.
- (5) Please attach the tube insulation on the CnB and CnT2-1 connectors after wiring.
- (6) Please fix a relay kit with 2 screws (to be procured on the installer's part) on the back of the ceiling or a wall in the proximity of an indoor unit. When fix a relay kit, do not pinch the earth wire between a relay kit and mounting surface.
- (7) When installation work is completed, please check the above-mentioned points for any connection errors.

5.4 Procedure to attach or remove the front panel

(1) Purpose

- Easier to find the holes to fit the screws
- Improves serviceability

(2) Point of change

- Holes of the pancele are bigger ($\phi 7$ (KX6) \rightarrow $\phi 8$ (KXZ))
- Hooks have been added

(3) Assembly and removal of front panel

- Removal

(a) Left front panel:

- ① Slide the front panel upward by approx. 10 mm to release claws.
- ② When the claws are released, pull the front panel to this side to remove.

(b) Right front panel:

- ① Tilt at first the top of right front panel to this side in order to avoid interference with the front panel (Upper) which is installed at the top.
- ② In this condition, slide the front panel upward by approx. 10 mm to release claws.
- ③ When the claws are released, pull the front panel to this side to remove.

- Assembly

Assemble in the reverse order of removal.

(4) Location of claws on front panel

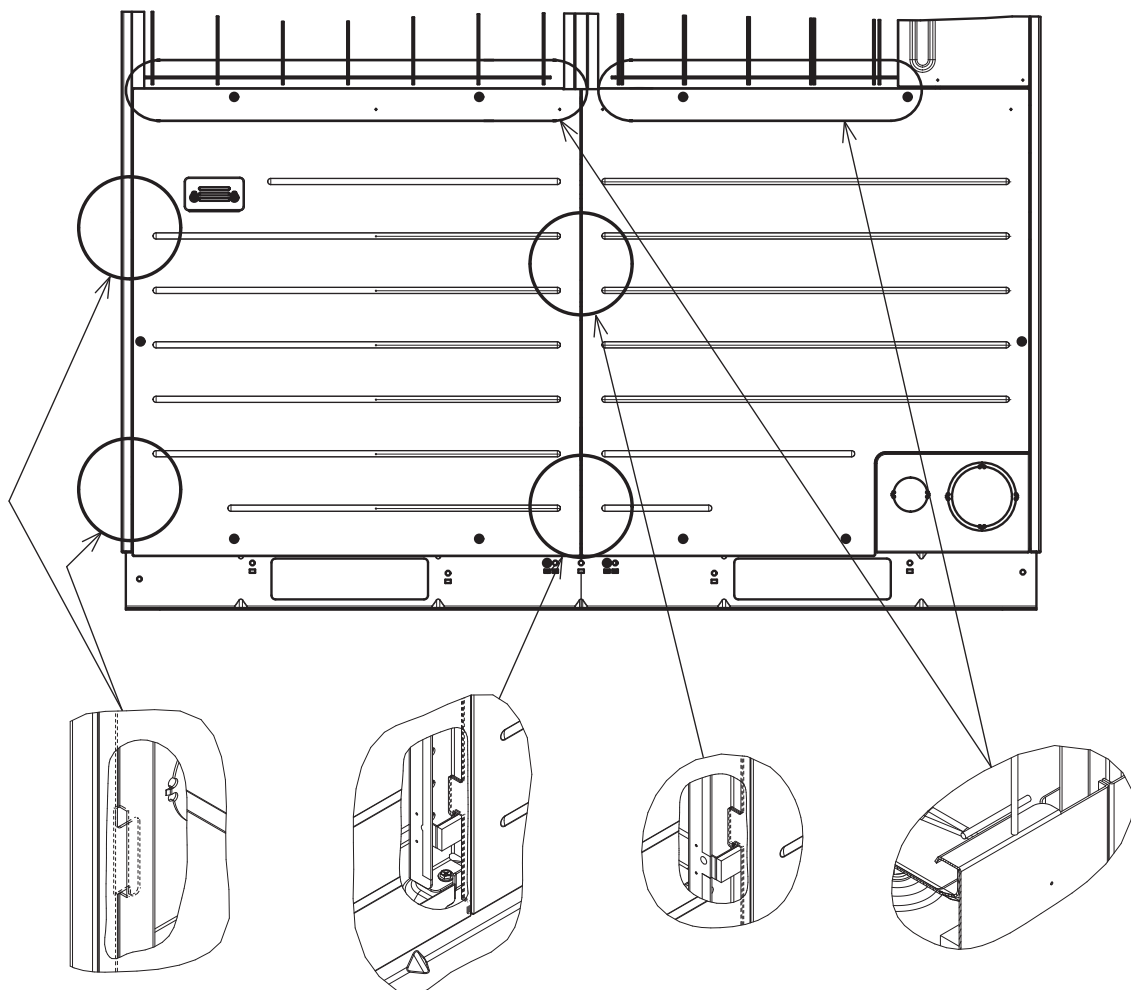

5.5 Installation work check sheet

Site name and system name	Checker: section, name	Date
---------------------------	------------------------	------

Please write the model name and serial number.

Sorting	Check item	Standard	Result	Action or value	Date
1.Indoor unit	①Is the installation space within allowable limit?	Check the technical manual.(Flow pattern, short-circuit, installation space)			
	②Is the installation position (the position of suspension bolts) fit to the ceiling space?	Check the position of suspension bolts and ceiling space.			
	③Did you use the suspension bolt of specified size?	Check the technical manual.(M10 or M8)			
	④It has a protective shielding to avoid the weld spatter?	Don't unpack before installation. Protect with cardboards etc. during installation.			
	⑤Is the air condition in the ceiling under the limitation? (Against dew condensation)	Dew-point temperature below 28°C, RH below 80%.			
	⑥Is there the gap on the piping insulation?	Be sure to seal the gaps of insulation and flare nuts. Don't damage the insulation.			
	⑦The horizontal drain piping has downward slope?	The adequate slope is 1/50~1/100 trap piping is prohibited.			
	⑧No trap on the vertical drain piping ?	Don't attach a trap when the indoor unit is installed whose external static pressure is 0 Pa.(Except the duct type unit)			
	⑨The connection with concentrated drain piping goes from upward?	Connect from the upper part of concentrated drain piping.			
	⑩Is it correct that the standing height of drain piping connected to the indoor unit?	Within 600~750mm from ceiling board or lower part of the unit.(FDR)			
	⑪Does the drain piping stand at the nearest point from the unit?	Stand at the position within 295~325mm from the unit.			
	⑫Is the drain hose the accessory of indoor unit?	Be sure to use the accessory drain hose.			
	⑬Is the drain hose fixed by the accessory band?	Don't use the adhesion bond.			
	⑭Does the drain piping suck odor from the drain tub?	There mustn't be the strange odor near the outlet of the drain piping.			
	⑮Is the drain piping insulated ? (Against dew condensation)	Insulation work must be performed. (The drain temperature is about 5°C)			
	⑯Is the drain piping supported with correct interval?	The interval for vinyl piping: 1m, The interval for copper piping: 2m			
	⑰Are the number of connected indoor units and the total capacity within the limit?	Refer to technical manual and installation manual.			The indoor unit capacity: % The number of connected indoor unit:
2.Outdoor unit	①Is the installation space within allowable limit?(No short-circuit)	Check the technical manual. It must be 3°C or less that the difference between the ambient temperature and the one around outdoor unit.			
	②Is the slave unit switch set correctly in case of combination system?	Master SW4-7=OFF, SW4-8=OFF Slave1 SW4-7=ON, SW4-8=OFF Slave2 SW4-7=OFF, SW4-8=ON			
	③Is the installation base fixed surely? Is the base bolt fixed? The discharging of drain and rain is OK?	Check if the drain water, rain water are discharged surely. Refer to the technical manual.			
	④Are the power sources of indoor and outdoor units independent from each other?	Basically, they must have its own power source.			
	⑤Are the power source for master and slave unit separated in case of combination system ?	The master and slave units must have their own power source.			
	⑥The power source voltage is within allowable limit?	The unbalance in each phase of power source: within ±3% Voltage drop at starting: -15% or more			
	⑦Do wiring and breaker adapt to the standard?	Check with technical manual.			
	⑧Each unit has its own earth leakage breaker?	Each unit must have its own earth leakage breaker.			
	⑨Was the grounding work performed?	The ground work should be done by qualified electrician.			
	⑩In case of combination system, the oil equalization piping between master and slave units is installed?	Be sure to install.			

Note) If the standard is satisfied, write down OK, if not, write down x and the action executed.(There are some items where you must write down values even if OK)

PSB012D941J

Sorting	Check item	Standard	Result	Action or value	date
3.System	① Is the material of refrigerant piping genuine?	Phosphorus deoxidized seamless copper pipe C1220T, JIS H 3300			
	② Is the length of refrigerant piping within allowable limit?	Check with the technical manual.		The length of piping: m The pipe length between the outdoor unit and the first branch: m	
	③ The height difference is within allowable limit?	Check the technical manual.		The height difference between indoor/outdoor unit: m indoor units: m	
	④ Are the pipe size and thickness decided based on the indoor unit capacity?	Check the technical manual. (The size and radial thickness depend upon indoor units capacity)			
	⑤ No trap or bump piping on the refrigerant piping?	Any trap or bump piping are prohibited.			
	⑥ When you perform piping welding, do you (a) use nitrogen , (b) cool the service valve?	(a)Perform it by running nitrogen or making substitution. (Against oxidized product)			
	⑦ During work, you executed measures to prevent rain and dust from entering the piping by sealing the ends of piping?	The sealing must be solid not to be removed easily. The measure for preventing foreign substances from entering the piping.			
	⑧ Is the branch pipe genuine?	Check the part number of genuine product with technical manual.			
	⑨ Are the branch pipings properly set?	Check with technical manual. (Install horizontally or vertically)			
	⑩ Is the refrigerant piping supported with suspension bolts? (Vibration absorption).	Support with suspension bolts of exclusive use for refrigerant piping at every two meters.			
	⑪ Are the refrigerant pipings (both liquid and gas) insulated?	Use the material with over 120°C heat resistance. Use the material on which the dew condensation is not formed 0-5°C.			
	⑫ Are the measures for vibration absorption and insulation executed on the through-holes for the refrigerant piping in the wall and beam?	The measures for vibration absorption and heat insulation must be executed.			
	⑬ Was the air tight test performed? (Use nitrogen gas. Too high pressure is prohibited)	Pressure:4.15MPa No fluctuation of pressure for 24 hours. Refer to the technical manual about the pressure fluctuation caused from temperature.		The pressure value after 24 hours MPa	
	⑭ Was sufficient vacuuming performed ? (Both with liquid and gas pipings)	Keep -755mmHg or less and vacuum for over 60 minutes.		The vacuuming time min	
	⑮ Was the additional refrigerant quantity calculated?	Refer to the technical manual.		Additional refrigerant quantity kg	
	⑯ The specified amount of refrigerant was charged with measuring?	Use a scale. Charge the liquid refrigerant.			
	⑰ Are the total amount of refrigerant and additional charge recorded on the model name label?	Record the size and length of piping, and the amount of additional charge.			
4. Branching control (In the case of a cooling heating free multi model)	① Is the number of installed branching control within the limit?	Check with technical data sheets.			
	② Is the number of branching control to be connected to outdoor units within the limit?	Check with technical data sheets.			
	③ Do the number of indoor units and their combined total capacity tall within the allowance limits specified for the connected branching control?	Check with technical data sheets.			
	④ Are refrigerant pipes connected properly to the branching control?	Check with technical data sheets.			
	⑤ Is an Inspection port provided at the specified position for the branching control?	Check with technical data sheets.			
5. Communication network	① Are the signal line and the power line crossed?	If the resistance on the signal line terminal block is below 100Ω (Refer to the technical manual), the crossing may occur.			
	② Are the signal line and remote control line crossed?	Don't use the same lines.			
	③ No loop wiring on the signal lines?	Loop wiring is prohibited.			
	④ Are the type and size of the signal line right?	Type: shielded cord 0.75-1.25mm ² Connect the shield earth at both ends of signal line.			
	⑤ Is the length of signal line within usage limit?	Refer to the technical manual.			
	⑥ Is the Superlink protocol (new or previous SL) right?	If new and previous SL are mixed in the same SL network, turn on SW5-5 of all outdoor units.			
	⑦ Was the address number decided reasonably?	Consider the combination of indoor/outdoor units, the use of each room, operating time and tenant segmentation etc.			
	⑧ Was the address number of indoor/outdoor unit indicated clearly on the system diagram (The layout drawing of indoor unit etc.)?	Write it down on the system diagram.			
	⑨ You handed over the address diagram to the worker and instructed to set address ?	You must instruct with a diagram basically.			
	⑩ The indoor address is set to 000 during auto address setting?	Set to 000. (Factory default: 000)			
6.Test run (The test run must be executed individually for each refrigerant system)	① Did you turn on power for 6 hours before the test run? Is the bottom of the compressor warm?	Turn on the crankcase heater for 6 hours before the test run. Or the bottom of compressor is warm enough.		The power-on time H	
	② Is each service valve opened?	Open the liquid and gas service valve, the oil equalization service valve.			
	③ No loose at the wiring connection?	Any loose at the wiring connection is prohibited.			
	④ Is the combination (address or refrigerant pipe) of indoor/outdoor units right?	Check whether the combination is right with the temperature of heat exchanger etc.			
	⑤ Are network connectors all connected without omission?	All network connectors are connected.			
	⑥ Can you confirm that the system hasn't any failure with the running data?	Refer to the test run procedure.			
	⑦ Did you perform the draining test?	Check the leakage and clogging of water.			

Note) If the standard is satisfied, write down OK, if not, write down x and the action executed.(There are some items where you must write down values even if OK)

VRF INVERTER MULTI-SYSTEM AIR-CONDITIONERS



MITSUBISHI HEAVY INDUSTRIES THERMAL SYSTEMS, LTD.

16-5 Konan 2-chome, Minato-ku, Tokyo, 108-8215, Japan

<http://www.mhi-mth.co.jp/en/>

Because of our policy of continuous improvement, we reserve the right to make changes in all specifications without notice.

© Copyright MITSUBISHI HEAVY INDUSTRIES THERMAL SYSTEMS, LTD.