

Air conditioner

Installation manual

AJ***TNLDEG / AJ052TNMDEG

- Thank you for purchasing this Samsung air conditioner.
- Before operating this unit, please read this manual carefully and retain it for future reference.



SAMSUNG

Contents

Safety Information	3
---------------------------	----------

Installation Procedure	6
-------------------------------	----------

- Step 1 Checking and preparing accessories
- Step 2 Choosing the installation location
- Step 3 Optional: Insulating the body of the indoor unit
- Step 4 Installing the indoor unit
- Step 5 Purging inert gas from the indoor unit
- Step 6 Cutting and flaring the pipes
- Step 7 Connecting the assembly pipes to the refrigerant pipes
- Step 8 Performing the gas leak test
- Step 9 Insulating the refrigerant pipes
- Step 10 Installing the drain hose and drain pipe
- Step 11 Performing the drainage test
- Step 12 Connecting the power and communication cables
- Step 13 Optional: Extending the power cable
- Step 14 Setting the indoor unit addresses and the installation options

Appendix	32
-----------------	-----------

Troubleshooting

Safety Information

WARNING: Read This Manual

- Read and follow all safety information and instructions before installation, use, or maintenance of this appliance. Incorrect installation, use, or maintenance of this appliance can result in death, serious injury, or property damage. Keep these instructions with this appliance. This manual is subject to change. For the latest version, visit www.samsung.com.

Notices and notes

To make you aware of safety messages and highlighted information, we use the following notices and notes throughout this manual:

WARNING

Hazards or unsafe practices that may result in severe personal injury or death.

CAUTION

Hazards or unsafe practices that may result in minor personal injury or property damage.

IMPORTANT

Information of special interest

NOTE

Supplementary information that may be useful



**WARNING: Low burning velocity material
(This appliance is filled with R-32.)**



The user and installer guides should be read carefully.



The user and installer guides should be read carefully.



The service guide should be read carefully.

WARNING

The installation and testing of this appliance must be performed by a qualified technician.

- The instructions in this manual are not intended as a substitute for proper training or adequate experience in the safe installation of the appliance.

Always install the air conditioner in compliance with current local, state, and federal safety standards.

Safety Information

General information

WARNING

- Carefully read the content of this manual before installing the air conditioner and store the manual in a safe place in order to be able to use it as reference after installation.
- For maximum safety, installers should always carefully read the following warnings.
- Store the operation and installation manual in a safe location and remember to hand it over to the new owner if the air conditioner is sold or transferred.
- This manual explains how to install an indoor unit with a split system with two SAMSUNG units. The use of other types of units with different control systems may damage the units and invalidate the warranty. The manufacturer shall not be responsible for damages arising from the use of non compliant units.
- The manufacturer shall not be responsible for damage originating from unauthorized changes or the improper connection of electric and requirements set forth in the "Operating limits" table, included in the manual, shall immediately invalidate the warranty.
- The air conditioner should be used only for the applications for which it has been designed: the indoor unit is not suitable to be installed in areas used for laundry.
- Do not use the units if damaged. If problems occur, switch the unit off and disconnect it from the power supply.
- In order to prevent electric shocks, fires or injuries, always stop the unit, disable the protection switch and contact SAMSUNG's technical support if the unit produces smoke, if the power cable is hot or damaged or if the unit is very noisy.
- Always remember to inspect the unit, electric connections, refrigerant tubes and protections regularly. These operations should be performed by qualified personnel only.
- The unit contains moving parts, which should always be kept out of the reach of children.
- Do not attempt to repair, move, alter or reinstall the unit. If performed by unauthorized personnel, these operations may cause electric shocks or fires.
- Do not place containers with liquids or other objects on the unit.
- All the materials used for the manufacture and packaging of the air conditioner are recyclable.
- The packing material and exhaust batteries of the remote controller(optional) must be disposed of in accordance with current laws.
- The air conditioner contains a refrigerant that has to be disposed of as special waste. At the end of its life cycle, the air conditioner must be disposed of in authorised centres or returned to the retailer so that it can be disposed of correctly and safely.
- Do not use means to accelerate the defrost operation or to clean, other than those recommended by Samsung.
- Do not pierce or burn.
- Be aware that refrigerants may not contain an odour.

Installing the unit

WARNING

IMPORTANT: When installing the unit, always remember to connect first the refrigerant tubes, then the electrical lines.

- Always disassemble the electric lines before the refrigerant tubes.
- Upon receipt, inspect the product to verify that it has not been damaged during transport. If the product appears damaged, DO NOT INSTALL it and immediately report the damage to the carrier or retailer (if the installer or the authorized technician has collected the material from the retailer.)
- After completing the installation, always carry out a functional test and provide the instructions on how to operate the air conditioner to the user.
- Do not use the air conditioner in environments with hazardous substances or close to equipment that release free flames to avoid the occurrence of fires, explosions or injuries.
- Do not install the product in a place where thermohygrostat is needed (such as server room, machinery room, computer room, etc.). Those places do not provide guaranteed operation condition of the product therefore performance can be poor in these places.
- Do not install the product in a ship or a vehicle (such as a campervan). Salt, vibration or other environmental factor may cause the product malfunction, electric shock or fire.
- Our units should be installed in compliance with the spaces shown in the installation manual, to ensure accessibility from both sides and allow repairs or maintenance operations to be carried out. The unit's components should be accessible and easy to disassemble without endangering people and objects. For this reason, when provisions of the installation manual are not complied with, the cost required to access and repair the units (in SAFETY CONDITIONS, as set out in prevailing regulations) with harnesses, ladders, scaffolding or any other elevation system will NOT be considered part of the warranty and will be charged to the end customer.

Power supply line, fuse or circuit breaker

WARNING

- Always make sure that the power supply is compliant with current safety standards. Always install the air conditioner in compliance with current local safety standards.
- Always verify that a suitable grounding connection is available.
- Verify that the voltage and frequency of the power supply comply with the specifications and that the installed power is sufficient to ensure the operation of any other domestic appliance connected to the same electric lines.
- Always verify that the cut-off and protection switches are suitably dimensioned.
- Verify that the air conditioner is connected to the power supply in accordance with the instructions provided in the wiring diagram included in the manual.
- Always verify that electric connections (cable entry, section of leads, protections...) are compliant with the electric specifications and with the instructions provided in the wiring scheme. Always verify that all connections comply with the standards applicable to the installation of air conditioners.
- Devices disconnected from the power supply should be completely disconnected in the condition of overvoltage category.
- Be sure not to perform power cable modification, extension wiring, and multiple wire connection.
 - It may cause electric shock or fire due to poor connection, poor insulation, or current limit override.
 - When extension wiring is required due to power line damage, refer to "Step 13 Optional: Extending the power cable" in the installation manual.

Safety Information

CAUTION

Make sure that you earth the cables.

- Do not connect the earth wire to the gas pipe, water pipe, lighting rod or telephone wire. If earthing is not complete, electric shock or fire may occur.

Install the circuit breaker.

- If the circuit breaker is not installed, electric shock or fire may occur.

Make sure that the condensed water dripping from the drain hose runs out properly and safely.

Install the power cable and communication cable of the indoor and outdoor unit at least 1m away from the electric appliance.

Install the indoor unit away from lighting apparatus using the ballast.

- If you use the wireless remote control, reception error may occur due to the ballast of the lighting apparatus.





Do not install the air conditioner in following places.





- Place where there is mineral oil or arsenic acid. Resin parts flame and the accessories may drop or water may leak. The capacity of the heat exchanger may reduce or the air conditioner may be out of order.
- The place where corrosive gas such as sulphuric acid gas generates from the vent pipe or air outlet.
- The copper pipe or connection pipe may corrode and refrigerant may leak.
- The place where there is a machine that generates electromagnetic waves. The air conditioner may not operate normally due to control system.
- The place where there is a danger of existing combustible gas, carbon fibre or flammable dust.
- The place where thinner or gasoline is handled. Gas may leak and it may cause fire.

Installation Procedure

Step 1 Checking and preparing accessories

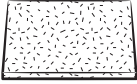
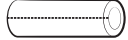
The following accessories are supplied with the indoor unit. The type and quantity may differ, depending on the specifications.

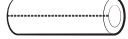
User manual (1)	Installation manual (1)
	
Clamp hose (1)	Flexible hose (1)
	

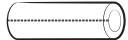
Insulation drain (1)	Thermal insulation sponge A (1)
	
Cable-tie (8)	Thermal insulation sponge B (1)
	
Rubber (8)	Thermal insulation sponge C (1)
	

Step 2 Choosing the installation location

WARNING

- Because your air conditioner contains R-32 refrigerant, make sure that it is installed, operated, and stored in a room whose floor area is larger than the minimum required floor area specified in the following table:

Ceiling-mounted type	
m (kg)	A (m ²)
≤ 1.842	No requirement
1.843	3.64
1.9	3.75
2.0	3.95
2.2	4.34
2.4	4.74
2.6	5.13
2.8	5.53
3.0	5.92
3.2	6.48
3.4	7.32
3.6	8.20
3.8	9.14
4.0	10.1
4.2	11.2
4.4	12.3
4.6	13.4
4.8	14.6
5.0	15.8

- m : Total refrigerant charge in the system
- A : Minimum required floor area
- **IMPORTANT:** it's mandatory to consider either the table above or taking into consideration the local law regarding the minimum living space of the premises.
- Minimum installation height of indoor unit is 0.6 m for floor mounted, 1.8 m for wall, 2.2 m for ceiling.

General requirements for installation location

Do not install the air conditioner in a location where it will come into contact with the following elements:

- Combustible gases

- Saline air
- Machine oil
- Sulphide gas
- Special environmental conditions

Avoid installing the air conditioner in a location with the following conditions:

- In areas where it is exposed to direct sunlight. Close to heat sources.
- In damp areas or locations where it could come into contact with water. (for example rooms used for laundry)
- In areas where curtains and furniture could affect the supply and discharge of air.
- Without leaving the required minimum space around the unit. (as shown in the drawing)
- In scarcely ventilated areas.
- On surfaces that are unable to support the weight of the unit without deforming, breaking or causing vibrations during the use of the air conditioner.
- In a position that does not enable the condensate drainage pipe to be correctly installed. (at the end of the installation. It is always essential to check the efficiency of the drainage system)
- The place where animals may urinate on the product. Ammonia may be generated.
- The place where is close to heat sources.
- Do not use the indoor unit for preservation of food items, plants, equipment, and art works. This may cause deterioration of their quality.
- Do not install the indoor unit if it has any drainage problem.

Space requirements for installation

Construction Standard for Inspection Hole

- In case, the ceiling is tex tile, Inspection hole dose not need.
- In case, the ceiling is plaster board, Inspection hole depends on Inside height of the ceiling.
 - Height is more than 0.5m : Only "B" [Inspection for PBA] is applied.
 - Height is less than 0.5m : Both "A"&"B" are applied.
 - "A"&"B" are inspection holes .

Installation Procedure

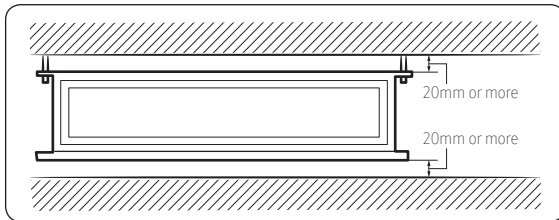
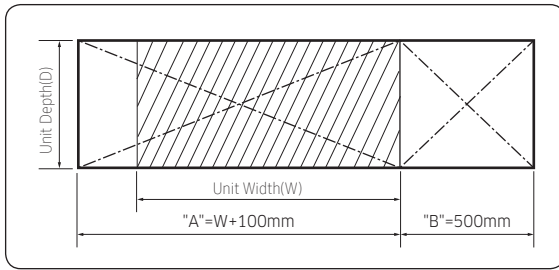

- You must have 20 mm or more space between the ceiling and the bottom of indoor unit. Otherwise, the noise from the vibration of indoor unit may bother the user. When the ceiling is under construction, the hole for check-up must be made to take service, clean and repair the unit.
- It is possible to install the unit at an height of between 2.2~2.5 m from the ground, if the unit has a duct with a well defined length (300 mm or more), to avoid fan motor blower contact.
- If you install the cassette or duct type indoor unit on the ceiling with humidity over 80%, you must apply extra 10 mm of polyethylene foam or other insulation with similar material on the body of the indoor unit.

Drawing of the indoor unit

AJ026TNLDEG / AJ035TNLDEG

(Unit: mm)

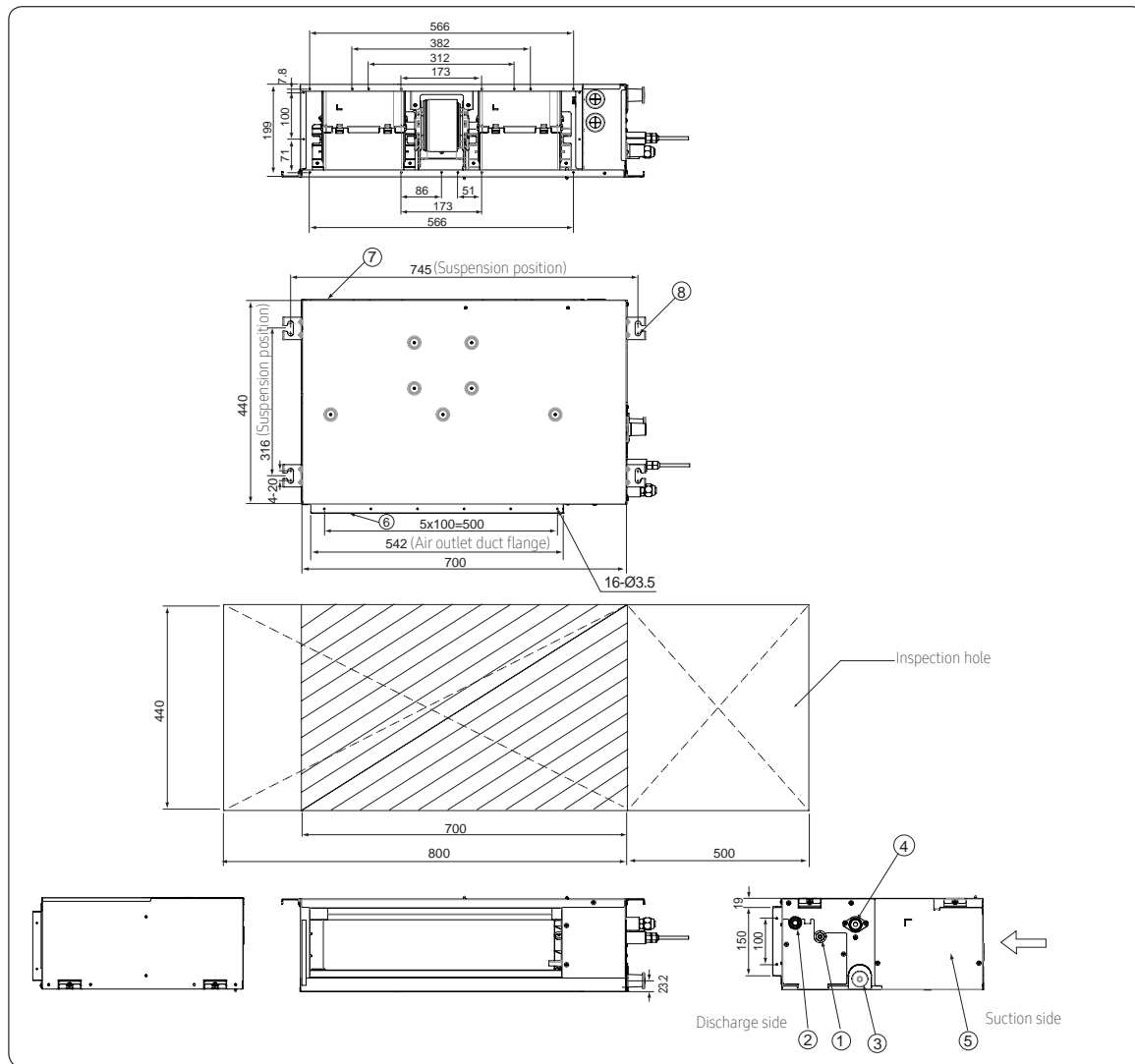

No.	Name	Description
1	Liquid pipe connection	ø6.35
2	Gas pipe connection	ø9.52
3	Hose connection	OD ø25, ID ø20
4	Hose connection	OD ø25, ID ø20
5	Power supply/Communication connection	
6	Power supply connection	
7	Air discharge grille flange	
8	Air inlet grille flange	M10

Installation Procedure

AJ052TNMDEG

(Unit: mm)

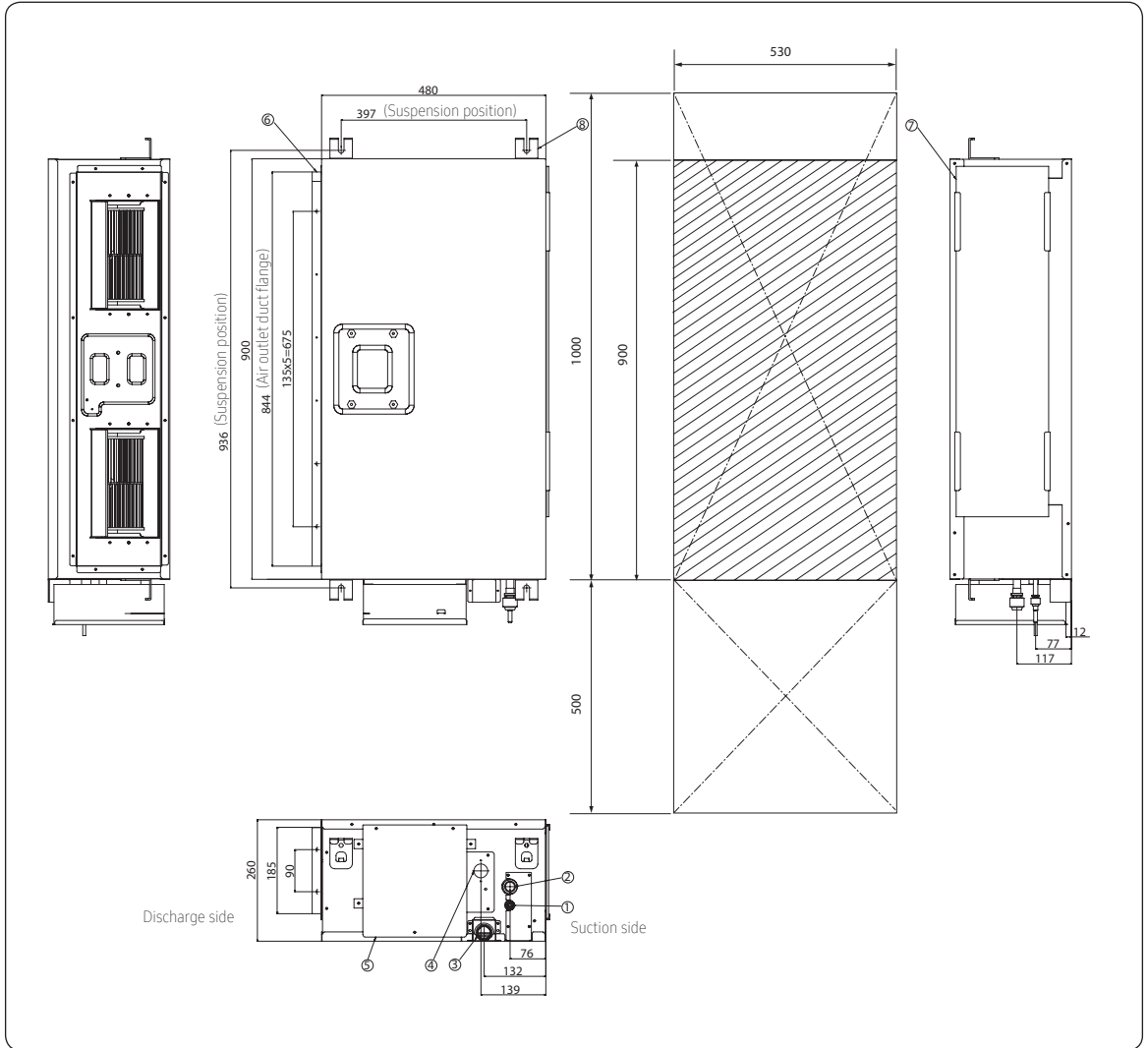

No.	Name	Description
1	Liquid pipe connection	ø6.35
2	Gas pipe connection	ø12.7
3	Drain pipe connection	OD25 ID20(without drain pump)
4	Drain pipe connection	Using drain pump (Optional)
5	Power supply connection	
6	Air discharge flange	
7	Air filter	
8	Hook	M8~M10

⚠ CAUTION

- Comply with the length and height limits described in the figure above.
- For the product that uses the R-32 refrigerant, Install the indoor unit on the wall 2.2 m or higher from the floor.

Step 3 Optional: Insulating the body of the indoor unit

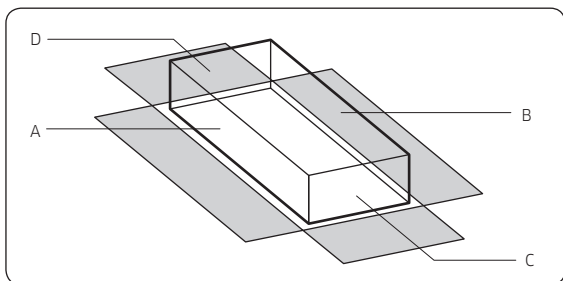

Thickness: more than 10mm

Indoor Unit	AJ026TNLDEG AJ035TNLDEG	AJ052TNMDEG
		700 X 440 X 199
A	700 X 200	900 X 260
B	700 X 200	900 X 260
C	440 X 200	480 X 260
D	440 X 200	480 X 260
Front/Back	Insulate the front and back side in proper size at the same time when insulating the suction duct and discharge duct.	

(Unit: mm)

📄 NOTE

- Insulate the end of the pipe and some curved area by using separate insulator.
- Insulate the discharge and suction part at the same time when you insulate connection duct.

Step 4 Installing the indoor unit

When deciding on the location of the air conditioner with the owner, the following restrictions must be taken into account

- 1 Place the pattern sheet on the ceiling at the spot where you want to install the indoor unit.

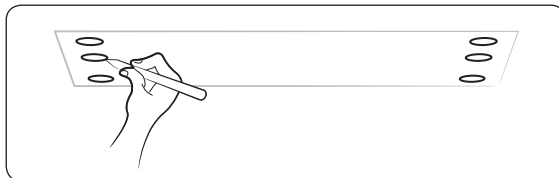

📄 NOTE

- Since the diagram is made of paper, it may shrink or stretch slightly due to temperature or humidity. For this reason, before drilling the holes maintain the correct dimensions between the markings.
- 2 Insert bolt anchors. Use existing ceiling supports or construct a suitable support as shown in figure.

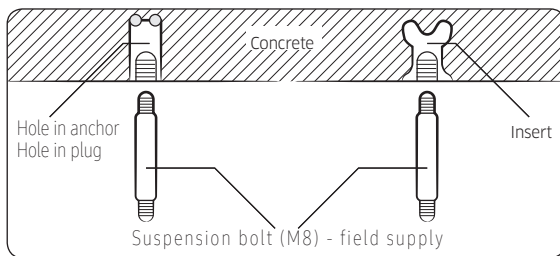

- 3 Install the suspension bolts depending on the ceiling type.

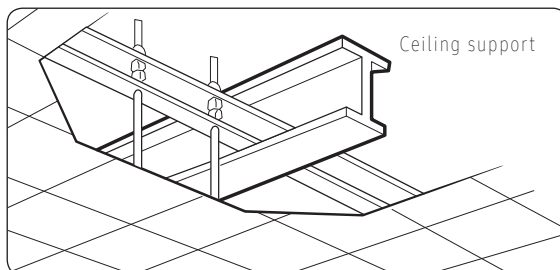

⚠ CAUTION

- Ensure that the ceiling is strong enough to support the weight of the indoor unit. Before hanging the unit, test the strength of each attached suspension bolt.

Installation Procedure

- If the length of suspension bolt is more than 1.5m, it is required to prevent vibration.
 - If this is not possible, create an opening on the false ceiling in order to be able to use it to perform the required operations on the indoor unit.
- 4 Screw eight nuts to the suspension bolts making space for hanging the indoor unit.

NOTE

- You must install all the suspension rods.
- 5 Hang the indoor unit to the suspension bolts between two nuts.

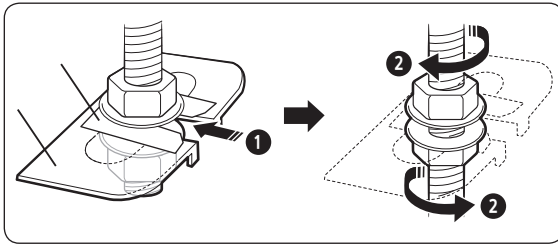

- When installing the indoor unit, make sure it is not tilted toward front or back side.

CAUTION

- Noise will increase 3~6 dB(A) when the air flow enters from the bottom side (Only for Slim Duct Type product).

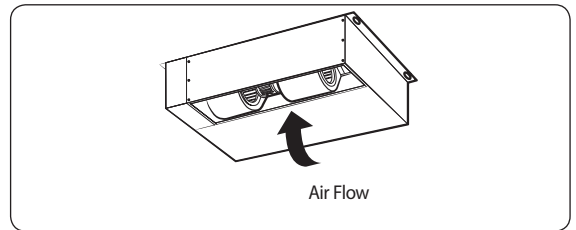

CAUTION

- Piping must be laid and connected inside the ceiling when suspending the unit. If the ceiling is already constructed, lay the piping into position for connection to the unit before placing the unit inside the ceiling.
- 6 Screw the nuts to suspend the unit.
- 7 Adjust level of the unit by using measurement plate for all 4 sides.

CAUTION

- For proper drainage of condensate, give a 3mm slant to the left or right side of the unit which will be connected with the drain hose, as shown in the figure. Make a tilt when you wish to install the drain pump, too.

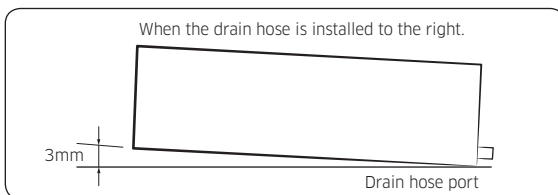

Step 5 Purging inert gas from the indoor unit

From factory the unit is supplied and set with a pre-charge of nitrogen gas. (inert gas) Therefore, all inert gas must be purged before connecting the assembly piping. Unscrew the pinch pipe at the end of each refrigerant pipe. Result : All inert gas escapes from the indoor unit.

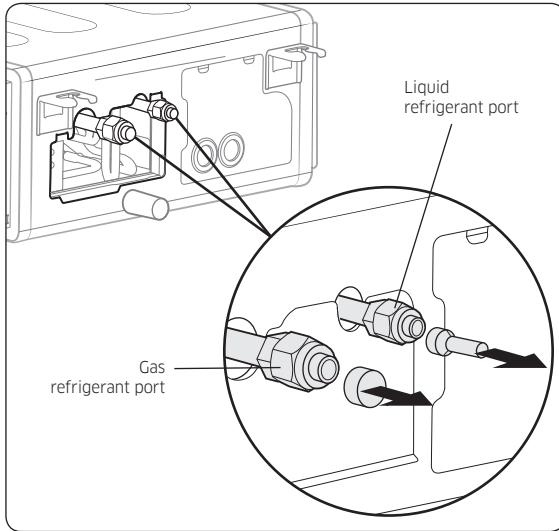

NOTE

- The designs and shape are subject to change according to the model.
- To prevent dirt or foreign objects from getting into the pipes during installation, do NOT remove the pinch pipe completely until you are ready to connect the piping.

CAUTION

- Connect the indoor and outdoor units using pipes with flared connections(not supplied). For the lines, use insulated, unwelded, degreased and deoxidized copper pipe (Cu DHP type to ISO 1337 or UNI EN 12735-1), suitable for operating pressures of at least 4200kPa and for a burst pressure of at least 20700kPa. Copper pipe for hydro-sanitary applications is completely unsuitable.
- For sizing and limits (height difference, line length, max. bends, refrigerant charge, etc.) see the outdoor unit installation manual.
- All refrigerant connection must be accessible, in order to permit either unit maintenance or removing it completely.

Step 6 Cutting and flaring the pipes

- 1 Make sure that you have the required tools available. (pipe cutter, reamer, flaring tool and pipe holder)
- 2 If you wish to shorten the pipes, cut it with a pipe cutter, taking care to ensure that the cut edge remains at a 90° angle with the side of the pipe. Refer to the illustrations below for examples of edges cut correctly and incorrectly.

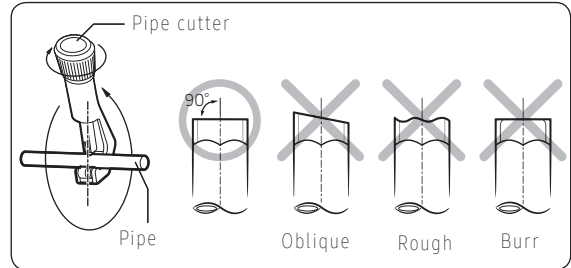

- 3 To prevent any gas from leaking out, remove all burrs at the cut edge of the pipe, using a reamer.
- 4 Slide a flare nut on to the pipe and modify the flare.

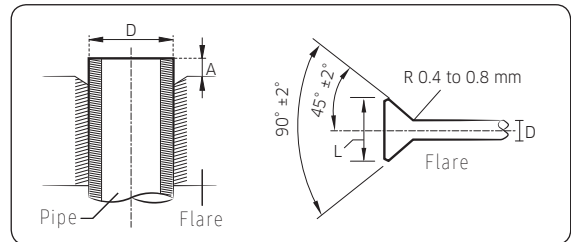

Outer Diameter (D)	Depth (A)	Flare dimension (L)
Ø6.35 mm	1.3 mm	8.7~9.1 mm
Ø9.52 mm	1.8 mm	12.8~13.2 mm
Ø12.70 mm	2.0 mm	16.2~16.6 mm
Ø15.88 mm	2.2 mm	19.3~19.7 mm

Installation Procedure

- 5 Check that the flaring is correct, referring to the illustrations below for examples of incorrect flaring.

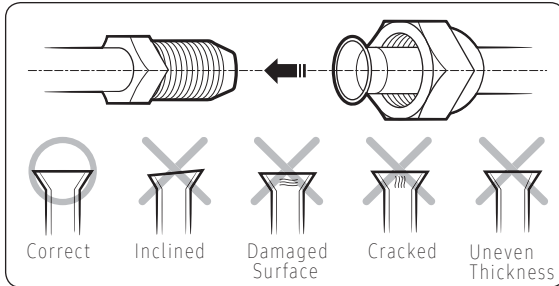

CAUTION

- If the pipes require brazing ensure that OFN (Oxygen Free Nitrogen) is flowing through the system.
- Nitrogen blowing pressure range is 0.02 ~ 0.05MPa.

Step 7 Connecting the assembly pipes to the refrigerant pipes

There are two refrigerant pipes of different diameters :

- A smaller one for the liquid refrigerant
- A larger one for the gas refrigerant
- The inside of copper pipe must be clean & has no dust

- 1 Remove the pinch pipe on the pipes and connect the assembly pipes to each pipe, tightening the nuts, first manually and then with a torque wrench, a spanner applying the following torque.

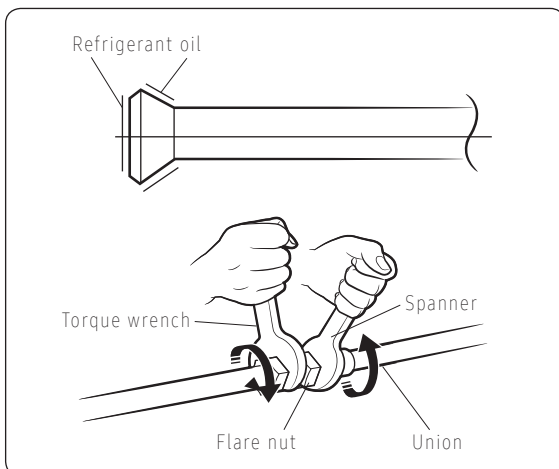

Outer diameter (D)	Torque (N•m)
Ø6.35 mm	14 ~ 18
Ø9.52 mm	34 ~ 42
Ø12.70 mm	49 ~ 61
Ø15.88 mm	68 ~ 82

NOTE

- If the pipes must be shortened refer to page **13**, **Step 6 Cutting and flaring the pipes**
- 2 Be sure to use insulator which is thick enough to cover the refrigerant tube to protect the condensate water on the outside of pipe falling onto the floor and the efficiency of the unit will be better.
- 3 Cut off any excess foam insulation.
- 4 Be sure that there must be no crack or wave on the bended area.
- 5 It would be necessary to double the insulation thickness(10mm or more) to prevent condensation even on the insulator when if the installed area is warm and humid.
- 6 Do not use joints or extensions for the pipes that connect the indoor and outdoor unit. The only permitted connections are those for which the units are designed.

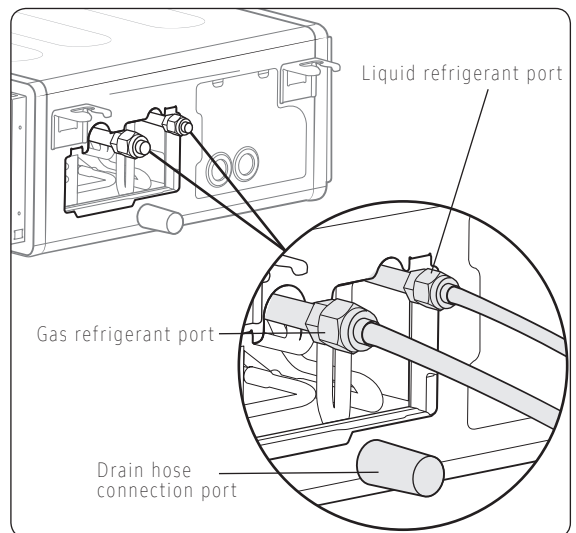

NOTE

- The designs and shape are subject to change according to the model.

Step 8 Performing the gas leak test

To identify potential gas leaks on the indoor unit, inspect the connection area of each refrigerant pipe using a leak detector for R-410A.

Before recreating the vacuum and recirculating the refrigerant gas, pressurize the whole system with nitrogen (using a cylinder with a pressure reducer) at a pressure above 4 MPa in order to immediately detect leaks on the refrigerant fittings.

Made vacuum for 15 minutes and pressurizing system with nitrogen.

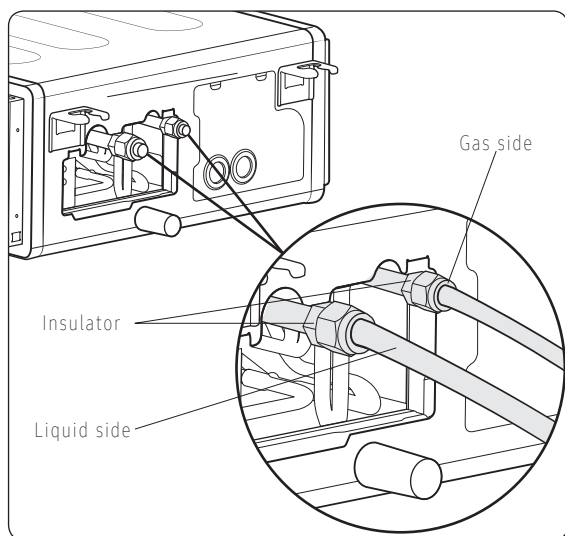

Step 9 Insulating the refrigerant pipes

Once you have checked that there are no leaks in the system, you can insulate the piping and hose.

- 1 To avoid condensation problems, place Acrylonitrile Butadiene Rubber separately around each refrigerant pipe.

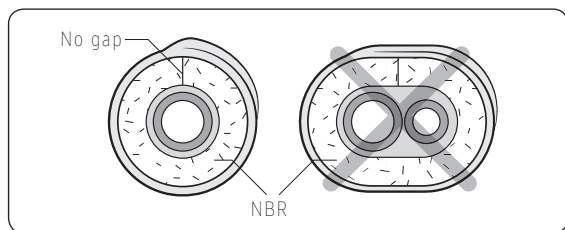

NOTE

- Always make the seam of pipes face upwards.

- 2 Wind insulating tape around the pipes and drain hose avoiding compressing the insulation too much.

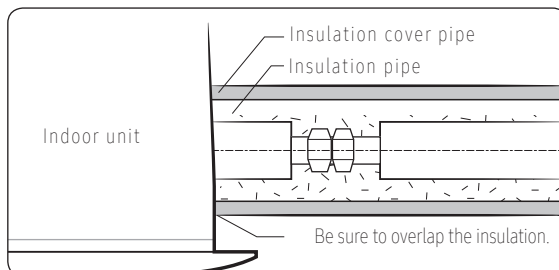

CAUTION

- Be sure to wrap insulation tightly without any gaps.
- 3 Finish wrapping insulating tape around the rest of the pipes leading to the outdoor unit.
 - 4 The pipes and electrical cables connecting the indoor unit with the outdoor unit must be fixed to the wall with suitable ducts.

CAUTION

- Make sure that all refrigerant connection must be accessible for easy maintenance and detachment.
- Install the insulation not to get wider and use the adhesives on the connection part of it to prevent moisture from entering.
- Wind the refrigerant pipe with insulation tape if it is exposed to outside sunlight.
- Install the refrigerant pipe respecting that the insulation does not get thinner on the bent part or hanger of pipe.
- Add the additional insulation if the insulation plate gets thinner.

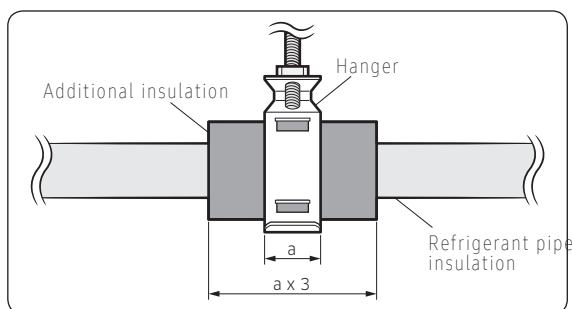

Installation Procedure

5 Select the insulation of the refrigerant pipe.

- Insulate the gas side and liquid side pipe, noting the insulation thickness that must differ according to the pipe size.
- Standard: Less than an indoor temperature of 30°C, with humidity at 85%. If installing in a high humidity environment, use one grade thicker insulator by referring to the table below. If installing in an unfavourable environment, use thicker one.
- The heat-resistance temperature of the insulator must be more than 120°C.

Pipe	Pipe size	Insulation type (heating/cooling)		Remarks
		Standard (Less than 30°C, 85%)	High humidity (Over 30°C, 85%)	
		EPDM, NBR		
Liquid pipe	Ø6.35 to Ø9.52	9t	9t	The internal temperature is higher than 120°C.
	Ø12.7 to Ø15.88	13t	13t	
Gas pipe	Ø6.35	13t	19t	
	Ø9.52	19t	25t	
	Ø12.70			
	Ø15.88			

- When installing insulation in the places and conditions below, use the same insulation that is used for high humidity conditions.

<Geological condition>
High humidity locations such as shorelines, hot springs, lake or riversides, and ridges (when part of the building is covered by earth and sand)
<Operation purpose condition>
Restaurant ceiling, sauna, swimming pool etc.
<Building construction condition>
Ceilings frequently exposed to moisture and cooling are not covered. For example, pipes installed at a corridor of a dormitory and studio or near an exit that opens and closes frequently.
Places (where the pipes are installed) that are highly humid due to a lack of ventilation.

Step 10 Installing the drain hose and drain pipe

- 1 Push the supplied drain hose as far as possible over the drain socket.
- 2 Tighten the metal clamp as shown in the picture.

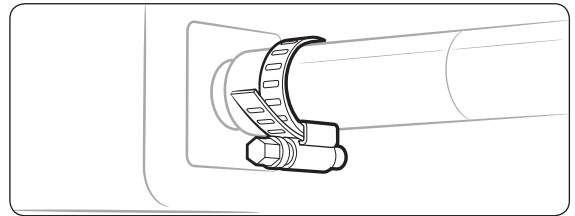

- 3 Wrap the supplied large sealing pad over the metal clamp and drain hose to insulate and fix it with clamps.
- 4 Insulate the complete drain piping inside the building (field supply).
If the drain hose cannot be sufficiently set on a slope, fit the hose with drain raising piping (field supply).
- 5 Push the drain hose up to insulation when connecting the drain hose to drain socket.

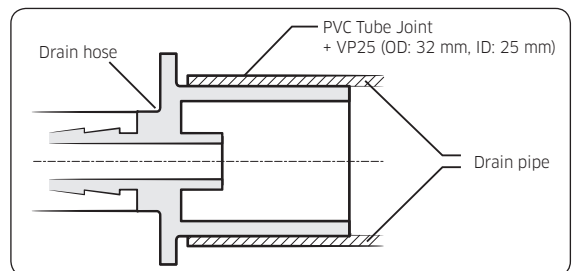
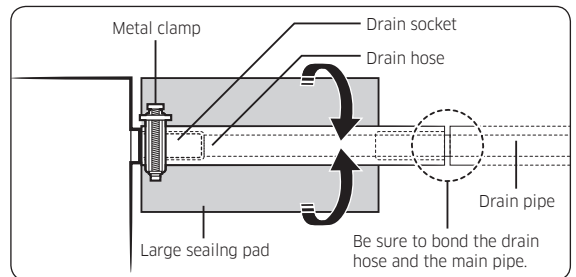

Without the drain pump

- 1 Install horizontal drainpipe with a slope of 1/100 or more and fix it by hanger space of 1.0~1.5m.
- 1 Install U-trap at the end of the drainpipe to prevent a nasty smell to reach the indoor unit.
- 2 Do not install the drainpipe to upward position. It may cause water flow back to the unit.

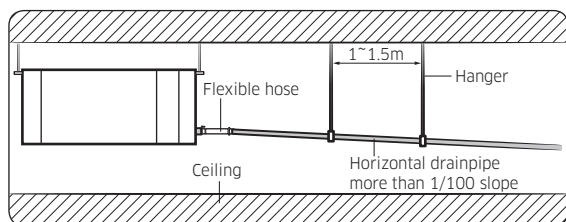

With the drain pump

- 1 The drain pipe should be installed within 300mm to 550mm from the flexible hose and then lift down 20mm or more.
- 2 Install horizontal drainpipe with a slope of 1/100 or more and fix it by hanger space of 1.0~1.5m.
- 3 Install the air vent in the horizontal drainpipe to prevent water flow back to the indoor unit.

NOTE

- You may not need to install it if there were proper slope in the horizontal drainpipe.
- 4 The flexible hose should not be installed upward position, it may cause water flow back to the indoor unit.

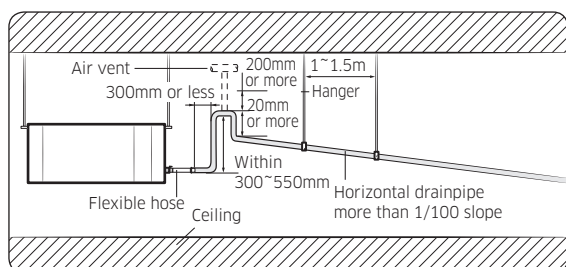

Step 11 Performing the drainage test

Prepare a little water about 2 liter.

- 1 Pour water into the base pan in the indoor unit as shown in figure.
- 2 Confirm that the water flows out through the drain hose.

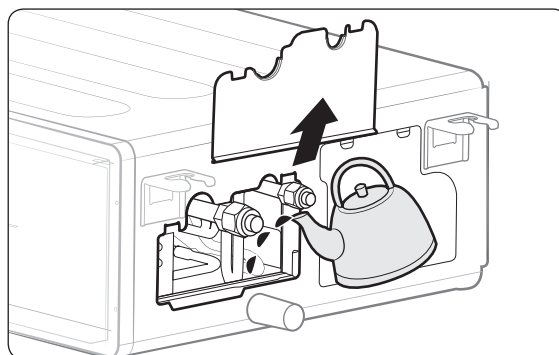

Step 12 Connecting the power and communication cables

CAUTION

- Always remember to connect the refrigerant pipes before performing the electric connections. When disconnecting the system, always disconnect the electric cables before disconnecting the refrigerant pipes.
- For the product that uses the R-32 refrigerant, be cautious not to generate a spark by keeping the following requirements:
 - Do not remove the fuses with power on.
 - Do not disconnect the power plug from the wall outlet with power on.
 - It is recommended to locate the outlet in a high position.
- Always remember to connect the air conditioner to the grounding system before performing the electric connections. Use a crimp ring terminal at the end of each wire.

The indoor unit is powered through the outdoor unit by means of a H07 RN-F connection cable (or a more power model), with insulation in synthetic rubber and a jacket in polychloroprene (neoprene), in accordance with the requirements specified in the standard EN 60335-2-40.

- 1 Remove the screw on the electrical component box and remove the cover plate.
- 2 Route the connection cord through the side of the indoor unit and connect the cable to the terminals refer to the figure below.
- 3 Route the other end of the cable to the outdoor unit through the ceiling & the hole on the wall.
- 4 Reassemble the electrical component box cover, carefully tightening the screw.

Installation Procedure

When using ELB for 1 phase

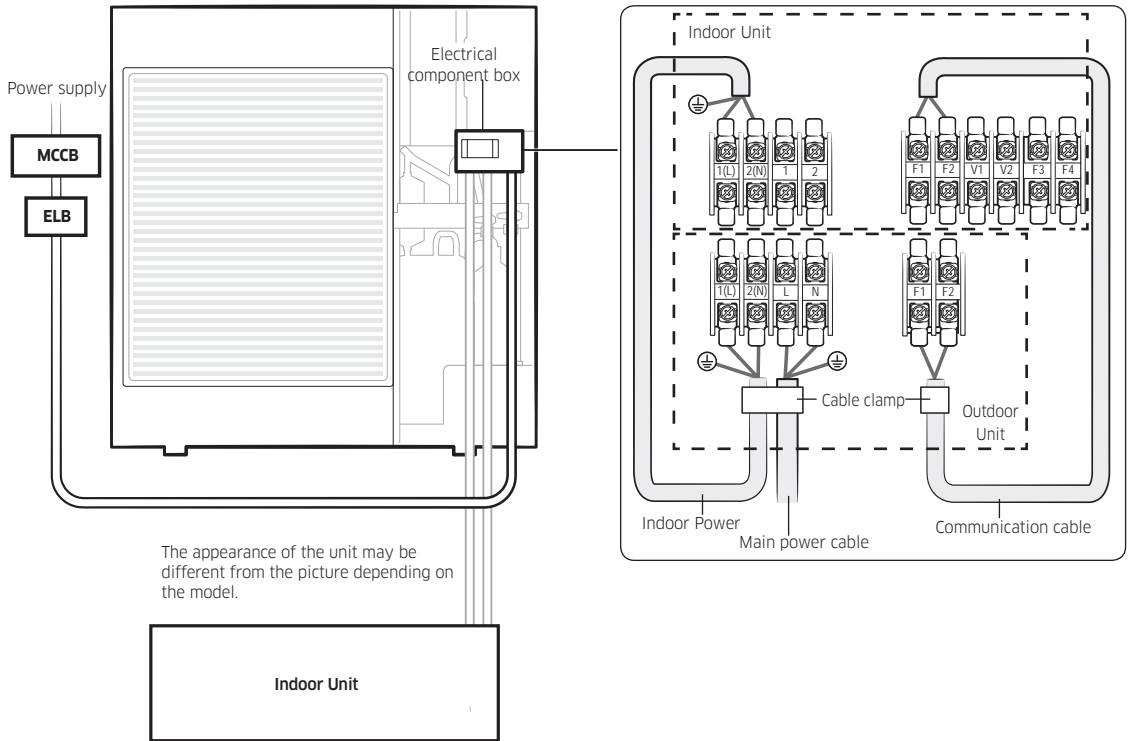

⚠ CAUTION

- You should connect the power cable into the power cable terminal and fasten it with a clamp.
- To protect the product from water and possible shock, you should keep the power cable and the connection cord of the indoor and outdoor units within ducts. (with appropriate IP rating and material selection for your application)
- Ensure that main supply connection is made through a switch that disconnects all poles, with contact gap of a least 3 mm.
- Devices disconnected from the power supply should be completely disconnected in the condition of overvoltage category.
- Keep distances of 50 mm or more between power cable and communication cable.

Indoor power supply		
Power supply	Max/Min(V)	Indoor power cable
220 to 240V, 50 Hz	±10%	0.75 to 1.5 mm ² , 3 wires
Communication cable		
0.75 to 1.5 mm ² , 2 wires		

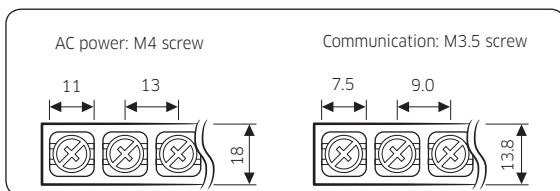

Tightening torque (kgf • cm)	
M3.5	8.0 to 12.0
M4	12.0 to 18.0

- 1 N·m = 10 kgf·cm
- Power supply cords of parts of appliances for outdoor use shall not be lighter than polychloroprene sheathed flexible cord. (Code designation IEC:60245 IEC 57 / CENELEC: H05RN-F or IEC:60245 IEC 66 / CENELEC: H07RN-F)
- Since it has the external power supply, refer to the outdoor unit installation manual for MAIN POWER.

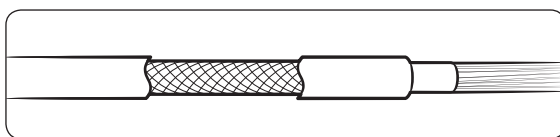

CAUTION

- When installing the indoor unit in a computer room or a server room, use the double shielded communication cable (tape aluminum / polyester braid + copper) of FROHH2R type.

Step 13 Optional: Extending the power cable

1 Prepare the following tools.

Tools	Spec	Shape
Crimping pliers	MH-14	
Connection sleeve (mm)	20xØ6.5 (HxOD)	
Insulation tape	Width 19 mm	
Contraction tube (mm)	70xØ8.0 (LxOD)	

2 As shown in the figure, peel off the shields from the rubber and wire of the power cable.

- Peel off 20 mm of cable shields from the pre-installed tube.

CAUTION

- For information about the power cable specifications for indoor and outdoor units, refer to the installation manual.
- After peeling off cable wires from the pre-installed tube, insert a contraction tube.
- If cable wires are connected without using connecting sleeves, their contact area becomes reduced, or corrosion develops on the outer surfaces of the wires (copper wires) over a long time. This may cause an increase of resistance (reduction of passing current) and consequently may result in a fire.

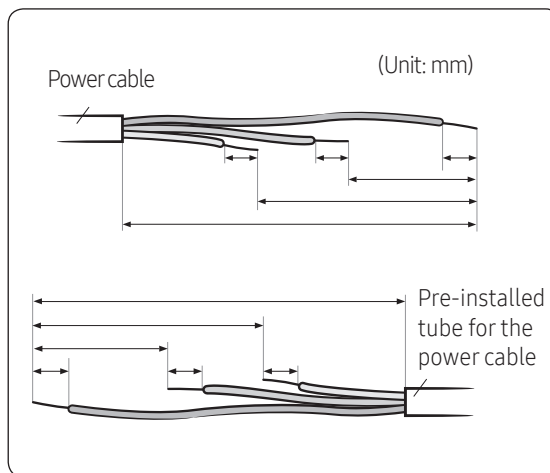

Installation Procedure

- 3 Insert both sides of core wire of the power cable into the connection sleeve.
- Method 1: Push the core wire into the sleeve from both sides.
 - Method 2: Twist the wire cores together and push it into the sleeve.

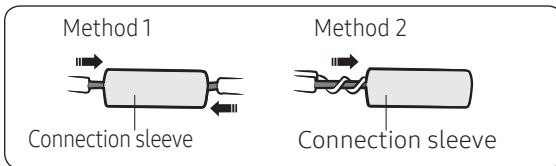

- 4 Using a crimping tool, compress the two points and flip it over and compress another two points in the same location.
- The compression dimension should be 8.0.

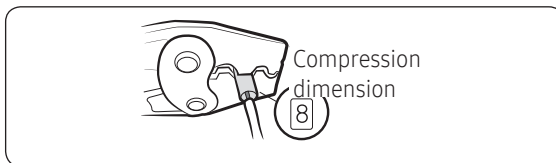

- After compressing it, pull both sides of the wire to make sure it is firmly pressed.

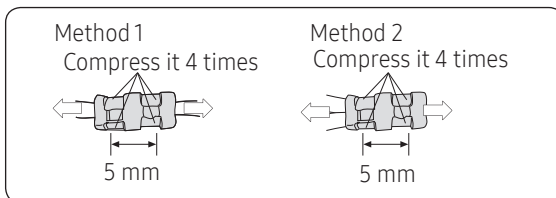

- 5 Wrap it with the insulation tape twice or more and position your contraction tube in the middle of the insulation tape.

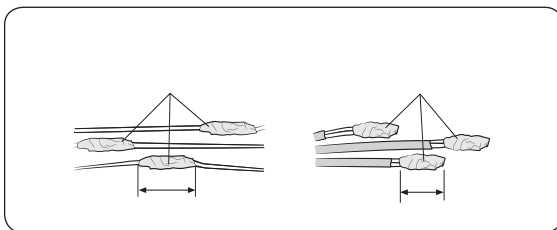

- 6 Apply heat to the contraction tube to contract it.

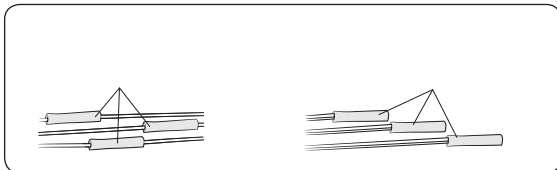

- 7 After tube contraction work is completed, wrap it with the insulation tape to finish. Three or more layers of insulation are required.

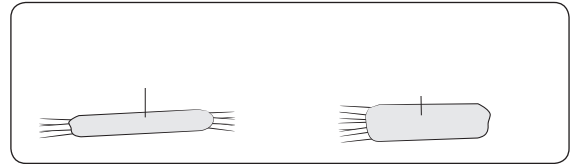

CAUTION

- Make sure that the connection parts are not exposed to outside.
- Be sure to use insulation tape and a contraction tube made of approved reinforced insulating materials that have the same level of withstand voltage with the power cable. (Comply with the local regulations on extensions.)

WARNING

- In case of extending the electric wire, please DO NOT use a round-shaped Pressing socket.
 - Incomplete wire connections can cause electric shock or a fire.

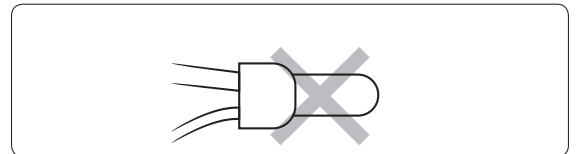

Step 14 Setting the indoor unit addresses and the installation options

You cannot set both of the indoor unit addresses and the installation options in a batch: set both of them respectively.

Common steps for setting the addresses and options

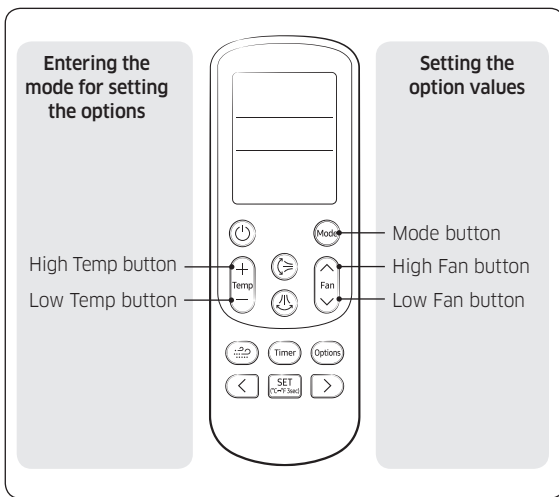

NOTE

- The remote control display and buttons may vary depending on the model.

- Enter the mode for setting the options:
 - Remove the batteries from the remote control, and then insert them again.
 - While holding down the (High Temp) and (Low Temp) buttons simultaneously, insert the batteries into the remote control.
 - Make sure that you are entered to the mode for setting the options:

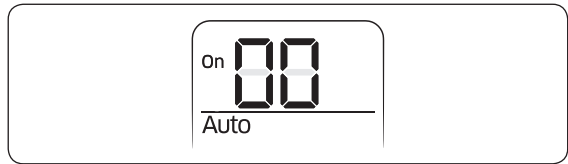

- Set the option values.

CAUTION













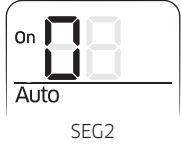
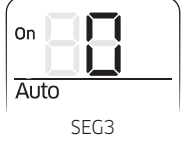

- The total number of available options are 24: SEG1 to SEG24.
- Because SEG1, SEG7, SEG13, and SEG19 are the page options used by the previous remote control models, the modes to set values for these options are skipped automatically.
- Set a 2-digit value for each option pair in the following order: SEG2 and SEG3 → SEG4 and SEG5 → SEG6 and SEG8 → SEG9 and SEG10 → SEG11 and SEG12 → SEG14 and SEG15 → SEG16 and SEG17 → SEG18 and SEG20 → SEG21 and SEG22 → SEG23 and SEG24

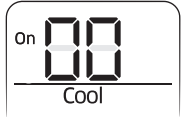



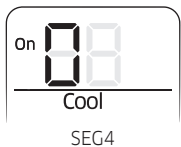
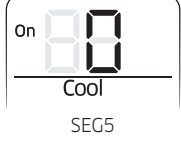

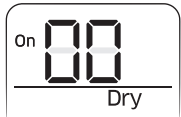

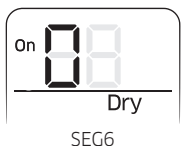
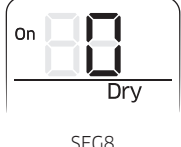

















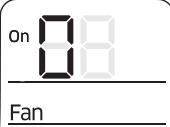
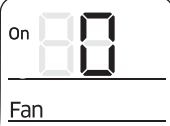

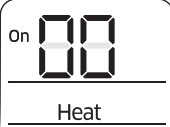
SEG1	SEG2	SEG3	SEG4	SEG5	SEG6
0	X	X	X	X	X
SEG7	SEG8	SEG9	SEG10	SEG11	SEG12
1	X	X	X	X	X
SEG13	SEG14	SEG15	SEG16	SEG17	SEG18
2	X	X	X	X	X
SEG19	SEG20	SEG21	SEG22	SEG23	SEG24
3	X	X	X	X	X

On (SEG1 to SEG12)	Off (SEG13 to SEG24)





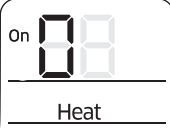
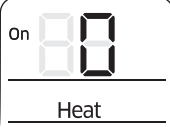









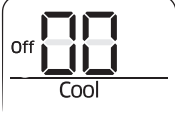

Installation Procedure



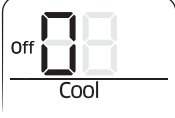
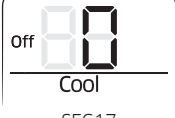



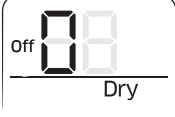







Take the steps presented in the following table:

Steps	Remote control display
<p>1 Set the SEG2 and SEG3 values:</p> <p>a Set the SEG2 value by pressing the  (Low Fan) button repeatedly until the value you want to set appears on the remote control display.</p> <p>b Set the SEG3 value by pressing the  (High Fan) button repeatedly until the value you want to set appears on the remote control display.</p> <p>When you press the  (Low Fan) or  (High Fan) button, values appear in the following order: 0 → 1 → ... E → F</p>	 
<p>2 Press the  (Mode) button. Cool and On appear on the remote control display.</p>	
<p>3 Set the SEG4 and SEG5 values:</p> <p>a Set the SEG4 value by pressing the  (Low Fan) button repeatedly until the value you want to set appears on the remote control display.</p> <p>b Set the SEG5 value by pressing the  (High Fan) button repeatedly until the value you want to set appears on the remote control display.</p> <p>When you press the  (Low Fan) or  (High Fan) button, values appear in the following order: 0 → 1 → ... E → F</p>	 
<p>4 Press the  (Mode) button. Dry and On appear on the remote control display.</p>	
<p>5 Set the SEG6 and SEG8 values:</p> <p>a Set the SEG6 value by pressing the  (Low Fan) button repeatedly until the value you want to set appears on the remote control display.</p> <p>b Set the SEG8 value by pressing the  (High Fan) button repeatedly until the value you want to set appears on the remote control display.</p>	 

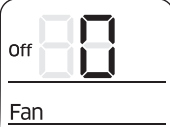
Steps	Remote control display
<p>When you press the  (Low Fan) or  (High Fan) button, values appear in the following order:  →  → ... →  → </p>	
<p>6 Press the  (Mode) button. Fan and On appear on the remote control display.</p>	
<p>7 Set the SEG9 and SEG10 values:</p> <p>a Set the SEG9 value by pressing the  (Low Fan) button repeatedly until the value you want to set appears on the remote control display.</p> <p>b Set the SEG10 value by pressing the  (High Fan) button repeatedly until the value you want to set appears on the remote control display.</p> <p>When you press the  (Low Fan) or  (High Fan) button, values appear in the following order:  →  → ... →  → </p>	 <p style="text-align: center;">SEG9</p>  <p style="text-align: center;">SEG10</p>
<p>8 Press the  (Mode) button. Heat and On appear on the remote control display.</p>	
<p>9 Set the SEG11 and SEG12 values:</p> <p>a Set the SEG11 value by pressing the  (Low Fan) button repeatedly until the value you want to set appears on the remote control display.</p> <p>b Set the SEG12 value by pressing the  (High Fan) button repeatedly until the value you want to set appears on the remote control display.</p> <p>When you press the  (Low Fan) or  (High Fan) button, values appear in the following order:  →  → ... →  → </p>	 <p style="text-align: center;">SEG11</p>  <p style="text-align: center;">SEG12</p>
<p>10 Press the  (Mode) button. Auto and Off appear on the remote control display.</p>	

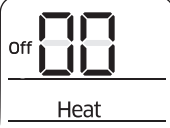
Installation Procedure

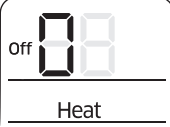
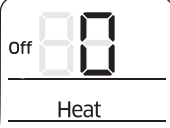

Steps	Remote control display
<p>11 Set the SEG14 and SEG15 values:</p> <p>a Set the SEG14 value by pressing the  (Low Fan) button repeatedly until the value you want to set appears on the remote control display.</p> <p>b Set the SEG15 value by pressing the  (High Fan) button repeatedly until the value you want to set appears on the remote control display.</p> <p>When you press the  (Low Fan) or  (High Fan) button, values appear in the following order: $\square \rightarrow \updownarrow \rightarrow \dots \rightarrow E \rightarrow F$</p>	 <p style="text-align: center;">SEG14</p>  <p style="text-align: center;">SEG15</p>
<p>12 Press the  (Mode) button. Cool and Off appear on the remote control display.</p>	
<p>13 Set the SEG16 and SEG17 values:</p> <p>a Set the SEG16 value by pressing the  (Low Fan) button repeatedly until the value you want to set appears on the remote control display.</p> <p>b Set the SEG17 value by pressing the  (High Fan) button repeatedly until the value you want to set appears on the remote control display.</p> <p>When you press the  (Low Fan) or  (High Fan) button, values appear in the following order: $\square \rightarrow \updownarrow \rightarrow \dots \rightarrow E \rightarrow F$</p>	 <p style="text-align: center;">SEG16</p>  <p style="text-align: center;">SEG17</p>
<p>14 Press the  (Mode) button. Dry and Off appear on the remote control display.</p>	
<p>15 Set the SEG18 and SEG20 values:</p> <p>a Set the SEG18 value by pressing the  (Low Fan) button repeatedly until the value you want to set appears on the remote control display.</p> <p>b Set the SEG20 value by pressing the  (High Fan) button repeatedly until the value you want to set appears on the remote control display.</p>	 <p style="text-align: center;">SEG18</p> 

Steps	Remote control display
<p>When you press the  (Low Fan) or  (High Fan) button, values appear in the following order: $\text{E} \rightarrow \text{F}$</p>	<p>SEG20</p>
<p>16 Press the  (Mode) button. Fan and Off appear on the remote control display.</p>	
<p>17 Set the SEG21 and SEG22 values:</p> <p>a Set the SEG21 value by pressing the  (Low Fan) button repeatedly until the value you want to set appears on the remote control display.</p> <p>b Set the SEG22 value by pressing the  (High Fan) button repeatedly until the value you want to set appears on the remote control display.</p> <p>When you press the  (Low Fan) or  (High Fan) button, values appear in the following order: $\text{E} \rightarrow \text{F}$</p>	 <p>SEG21</p>  <p>SEG22</p>
<p>18 Press the  (Mode) button. Heat and Off appear on the remote control display.</p>	
<p>19 Set the SEG23 and SEG24 values:</p> <p>a Set the SEG23 value by pressing the  (Low Fan) button repeatedly until the value you want to set appears on the remote control display.</p> <p>b Set the SEG24 value by pressing the  (High Fan) button repeatedly until the value you want to set appears on the remote control display.</p> <p>When you press the  (Low Fan) or  (High Fan) button, values appear in the following order: $\text{E} \rightarrow \text{F}$</p>	 <p>SEG23</p>  <p>SEG24</p>

Installation Procedure

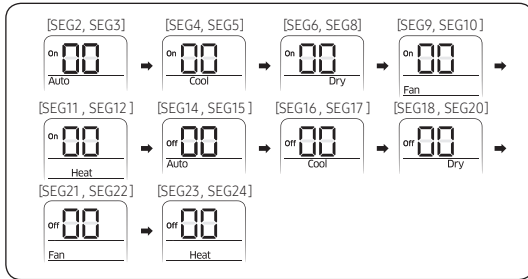
- 3 Check whether the option values that you have set are correct by pressing the  (Mode) button repeatedly



- 4 Save the option values into the indoor unit:
Point the remote control to the remote control sensor on the indoor unit and then press the  (Power) button on the remote control twice. Make sure that this command is received by the indoor unit. When it is successfully received, you can hear a short sound from the indoor unit. If the command is not received, press the  (Power) button again.
- 5 Check whether the air conditioner operates in accordance with the option values you have set:
- Reset the indoor unit by disconnecting and then reconnecting the power cable of the indoor unit or by pressing the RESET button on the outdoor unit.
 - Remove the batteries from the remote control, insert them again, and then press the  (Power) button on the remote control.

Setting the indoor unit address and installation option

- Make sure that the power is supplied to the indoor unit.
 - If the indoor unit is not plugged in, it must include a power supply.
- Make sure that the panel or display is connected to the indoor unit so that it can receive options

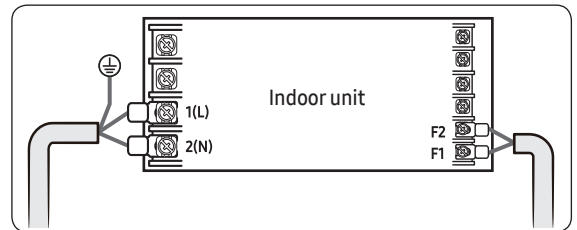

- Set an address and installation option for each indoor unit using the remote control, according to your air conditioning system plan.

Setting an indoor unit address (MAIN/RMC)

- The indoor unit address are set to 0A0000-100000-200000-300000 by default.

Option No. : 0AXXXX-1XXXXX-2XXXXX-3XXXXX

Option	SEG1		SEG2		SEG3		SEG4		SEG5		SEG6	
Explanation	Page		Mode		Setting main address		100-digit of indoor unit address		10-digit of indoor unit		A single digit of indoor unit	
Indication and details	Indication	Details	Indication	Details	Indication	Details	Indication	Details	Indication	Details	Indication	Details
	0		A		0	No Main address	0~9	100-digit	0~9	10-digit	0~9	A single digit
					1	Main address setting mode						
Option	SEG7		SEG8		SEG9		SEG10		SEG11		SEG12	
Explanation	PAGE		Reserved	Setting RMC address		Reserved	Group channel(*16)		Group address			
Indication and Details	Indication	Details		Indication	Details		Indication	Details	Indication	Details		
	1			0	No RMC address		RMC1	1~F	RMC2	1~F		
				1	RMC address setting mode							

✳ You must set RMC address setting mode when using the centralized Control.

CAUTION

- When "A"~"F" is entered to SEG4~6, the indoor unit MAIN ADDRESS is not changed.
- If you set the SEG 3 as 0, the indoor unit will maintain the previous MAIN ADDRESS even if you input the option value of SEG4~6.
- If you set the SEG 9 as 0, the indoor unit will maintain previous RMC ADDRESS even if you input the option value of SEG11~12.

Installation Procedure

Setting an indoor unit installation option (suitable for the condition of each installation location)

- The indoor unit installation option are set to 020000-100000-200000-300000 by default.
- Set the indoor unit option by wireless remote controller. When entering Address option, connect remote controller receiver.

Installation options

SEG1	SEG2	SEG3	SEG4	SEG5	SEG6
0	2	Reserved	Use of external room temperature sensor / Minimizing fan operation when thermostat is off	Use of central control	Compensation of the fan RPM
SEG7	SEG8	SEG9	SEG10	SEG11	SEG12
1	Using of drain pump	Use of Hot Coil	Use of Heater	Controller variables for auxiliary heater	Reserved
SEG13	SEG14	SEG15	SEG16	SEG17	SEG18
2	Use of external control	Setting the output of external control	Ionizer	Buzzer Control	Hours of filter usage
SEG19	SEG20	SEG21	SEG22	SEG23	SEG24
3	Individual control with remote control	Heating setting compensation offset	Reserved	Reserved	Reserved

- Even if you set the Use of drain pump (SEG8) option to 0, it is automatically set to 2 (the drain pump is used with 3 minute delay).
- If you set the Maximum filter usage time (SEG18) option to a value other than 2 and 6, it is automatically set to 2 (1000 hours).
- If you set an option to a value that is out of range specified above, the option is automatically set to 0 by default.
- The external output of SEG15 is generated via MIM-B14 connection. (Refer to the manual of MIM-B14.)
- If you set the Individual control with remote control (SEG20) option to a value other than 0 to 4, it is automatically set to 0 (Indoor 1).

Installation option (Detailed)

Option No. : 02XXXX-1XXXXX-2XXXXX-3XXXXX

Option	SEG1		SEG2		SEG3		SEG4			SEG5		SEG6	
Function	Page		Mode				Use of external room temperature sensor / Minimizing fan operation when thermostat is off			Use of central control		Compensation of the fan RPM	
Indication and details	Indication	Details	Indication	Details	Reserved	Indication	Details		Indication	Details	Indication	Details	
							Use of External room temperature sensor	Minimizing fan operation when thermostat is off					
	0		2			0	0	Default	Default	0	Disuse	0	Disuse (recessed installation)
						1		Use	Disuse				
						2		Disuse	Use (Heating)				
						3		Use	Use (Heating)				
						4		Disuse	Use (Cooling)				
						5		Use	Use (Cooling)				
						6		Disuse	Use (Heating / Cooling)				
						7		Use	Use (Heating / Cooling)				
						8		Disuse	Use (Cooling Ultra Low Fan)				
						9		Use	Use (Cooling Ultra Low Fan)	1	Use	1	RPM compensation
						A		Disuse	Use (Heating / Cooling Ultra Low Fan)				
				B		Use	Use (Heating / Cooling Ultra Low Fan)						
Option	SEG7		SEG8		SEG9		SEG10		SEG11			SEG12	
Function	Page		Use of drain pump		Use of Hot Coil		Use of heater		Controller variables for auxiliary heater			Reserved	
Indication and details	Indication	Details	Indication	Details	Indication	Details	Indication	Details	Indication	Details			
										Set temperature for auxiliary heat on	Time delay for auxiliary heat on		
	1		0	Disuse	0	Disuse	0	Disuse	0	0	No temperature offset		No delay
									1	1	No temperature offset		10 minutes
									2	2	No temperature offset		20 minutes
									3	1	1.5°C		No delay
									4	1	1.5°C		10 minutes
									5	1	1.5°C		20 minutes
									6	1	3°C		No delay
									7	1	3°C		10 minutes
									8	1	3°C		20 minutes
									9	2	4.5°C		No delay
									A	2	4.5°C	10 minutes	
								B	2	4.5°C	20 minutes		
								C	2	6°C	No delay		
								D	2	6°C	10 minutes		
								E	2	6°C	20 minutes		

Installation Procedure

Installation Procedure

Option	SEG13		SEG14		SEG15		SEG16		SEG17		SEG18									
Function	Page		Use of external control		Setting the output of external control		Ionizer		Buzzer control		Maximum filter usage time									
Indication and details	2	Indication	Details	Indication	Details	Indication	Details	Indication	Details	Indication	Details	Indication	Details							
		0	Disuse	Slave, Existing Control	0	Thermo on	0	Disuse	0	Use of buzzer	2	1000 hours	1	Operation on	1	Use	1	Disuse of buzzer	6	2000 hours
		1	On/Off																	
		2	Off																	
		3	Window																	
		4	Disuse	Master, Existing Control	1	Operation on	1	Use	1	Disuse of buzzer	6	2000 hours								
		5	On/Off																	
		6	Off																	
		7	Window																	
		8	Disuse	Slave, Existing Control	1	Operation on	1	Use	1	Disuse of buzzer	6	2000 hours								
		9	On/Off																	
		A	Off																	
		B	Window	Master, Existing Control	1	Operation on	1	Use	1	Disuse of buzzer	6	2000 hours								
		C	Disuse																	
		D	On/Off																	
E	Off																			
F	Window																			
Option	SEG19		SEG20		SEG21		SEG22		SEG23		SEG24									
Function	Page		Individual control with remote control		Heating setting compensation															
Indication and details	3	Indication	Details	Indication	Details	Indication	Details	Reserved	Reserved	Reserved	Reserved									
		0 or 1	Indoor 1	0	Default	2	5°C													
		2	Indoor 2	1	2°C															
		3	Indoor 3																	
		4	Indoor 4																	

- By SEG4 setting, Minimizing fan operation when thermostat is off.
 - Fan operates for 20 seconds at an interval of 5 minutes in Heat mode.
 - Fan stops or operates Ultra low in Cooling when thermostat is off.
- Even if you set the Use of drain pump (SEG8) option to 0, it is automatically set to 2 (the drain pump is used with 3 minute delay).
- If you set the Maximum filter usage time (SEG18) option to a value other than 2 and 6, it is automatically set to 2 (1000 hours).
- If you set the Individual control with remote control (SEG20) option to a value other than 0 to 4, it is automatically set to 0 (Indoor 1).
- Default value of Heating setting compensation (SEG21) is 2 .

Changing the addresses and options individually

When you want to change the value of a specific option, refer to the following table and follow the steps in **Common steps for setting the addresses and options** on page 21.

Option	SEG1		SEG2		SEG3		SEG4		SEG5		SEG6	
Function	Page		Mode		Type of the option to change		Tens position of the option number		Units position of the option number		New value	
Indication and details	Indication	Details	Indication	Details	Indication	Details	Indication	Details	Indication	Details	Indication	Details
		0		D		Option type	0 to F	Tens position value	0 to 9	Units position value	0 to 9	New value

Example: Changing the Buzzer control (SEG17) option of the installation options to 1 disuse.





























Option	SEG1		SEG2		SEG3		SEG4		SEG5		SEG6	
Function	Page		Mode		Type of the option to change		Tens position of the option number		Units position of the option number		New value	
Indication	0		D		2		1		7		1	

CAUTION

- If your indoor units support both cooling and heating, the mixed operation (two or more indoor units operate in different modes simultaneously) is not available when the indoor units are connected to the same outdoor unit. If you set an indoor unit as the master indoor unit by using the remote control, the outdoor unit automatically operate in the current mode of the master indoor unit.

Troubleshooting

- If an error occurs during the operation, one or more LED flickers and the operation is stopped except the LED.
- If you re-operate the air conditioner, it operates normally at first, then detect an error again.

Abnormal conditions	Indicators					Remarks
	Concealed Type					
	Green	Red				
	Standard Type					
						
Power reset		X	X	X	X	
Error of Room sensor in the indoor unit(Open/Short)	X	X		X	X	
Error of EVA-IN,EVA-OUT sensor in the indoor unit(Open/Short)		X		X	X	
Error of Fan motor in the indoor unit	X	X	X		X	
Error of Outdoor or Terminal Block Thermal Fuse(Open)	X	X				
Clogging of outdoor's service valve		X	X			
Detection of the float switch	X	X	X			
Error of EEPROM or OPTION SETTING						
1. No communication for 2 minutes between indoor units (Communication error for more than 2 minutes) 2. Indoor unit receiving the communication error from outdoor unit 3. Outdoor unit tracking 3 minutes error 4. When sending the communication error from the outdoor unit, the mismatching of the communication numbers and installed numbers after completion of tracking. (Communication error for more than 2 minutes)	X	X			X	1. Indoor unit error (Display is unrelated with operation) 2. Outdoor unit error (Display is unrelated with operation)

 On
  Flickering
  Off

If you turn off the air conditioner when the LED is flickering, the LED is also turned off.

- If an error occurs,  is displayed on the wired remote controller. If you would like to see an error code, press the Test button.

Display	Explanation	Remark
808	Communication Error between indoor and outdoor unit	
828	Error of Room sensor in the indoor unit(Open/Short)	
822	Error of Eva In sensor in the indoor unit(Open/Short)	
823	Error of Eva Out sensor in the indoor unit(Open/Short)	
853	2nd Detection of the float switch	
854	Error of Fan motor in the indoor unit	
862	EEPROM error	
863	EEPROM option setting error	
898	Error of Terminal Block's Thermal Fuse(Open)	
202	No communication for 2minutes between indoor units(Communication error for more than 2minutes)	
422	Clogging of outdoor's service valve	
558	Option code miss matching among the indoors (only for DPM)	Check indoor option code
608	Error of communication down between the indoor unit and wired remote controller after 3minutes.	Wired remote controller error
604	Error of communication down between the indoor unit and wired remote controller after completion of 10 times tracking.	
606	COM1/COM2 Cross-installed error	
608	Error of master wired remote controller and slave wired remote controller setting	

SAMSUNG