

Kanalgerät					
Artikel	Modell	Gerätemaß H-B-L, mm	Druckseite	Saugseite	Luftmenge max. 150Pa
11792	FBA100	245-1400-620	178x1192K	210x1354K	2040 m³/h
11793	FBA125				
11794	FBA140				



Kanaladapter 11792_ Übersicht

Datum: 2024-03-14

Plandatei: \\mt-nas-01\dwg_xref\klima\kizubehör\kanaladapter\daikin\24.5-140_fba100-140\11792_.dwg

Kanalgerät					
Artikel	Modell	Gerätemaß H-B-L, mm	Druckseite	Saugseite	Luftmenge max. 150Pa
11792	FBA100	245-1400-620	178x1192K	210x1354K	2040 m³/h
11793	FBA125				
11794	FBA140				

	2040	m³/h
5	180	Ø
	4,45	m/s

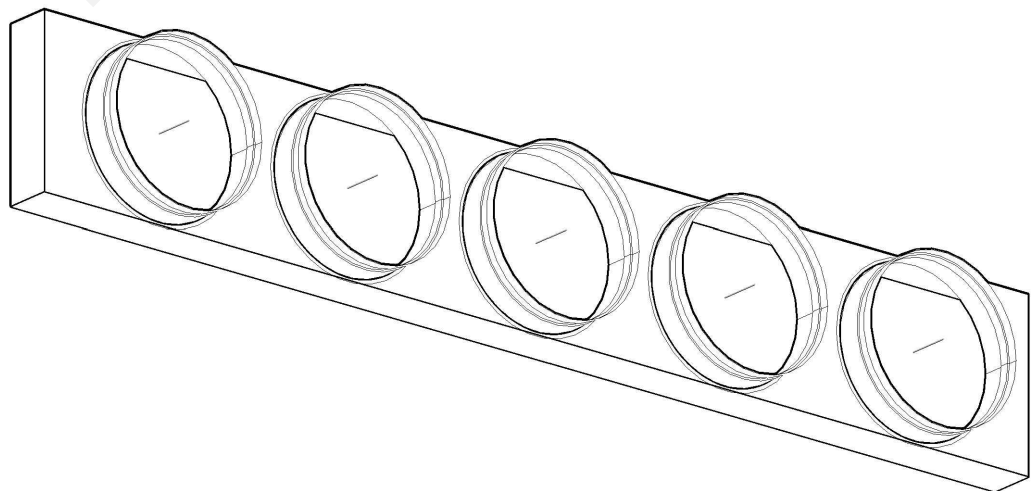
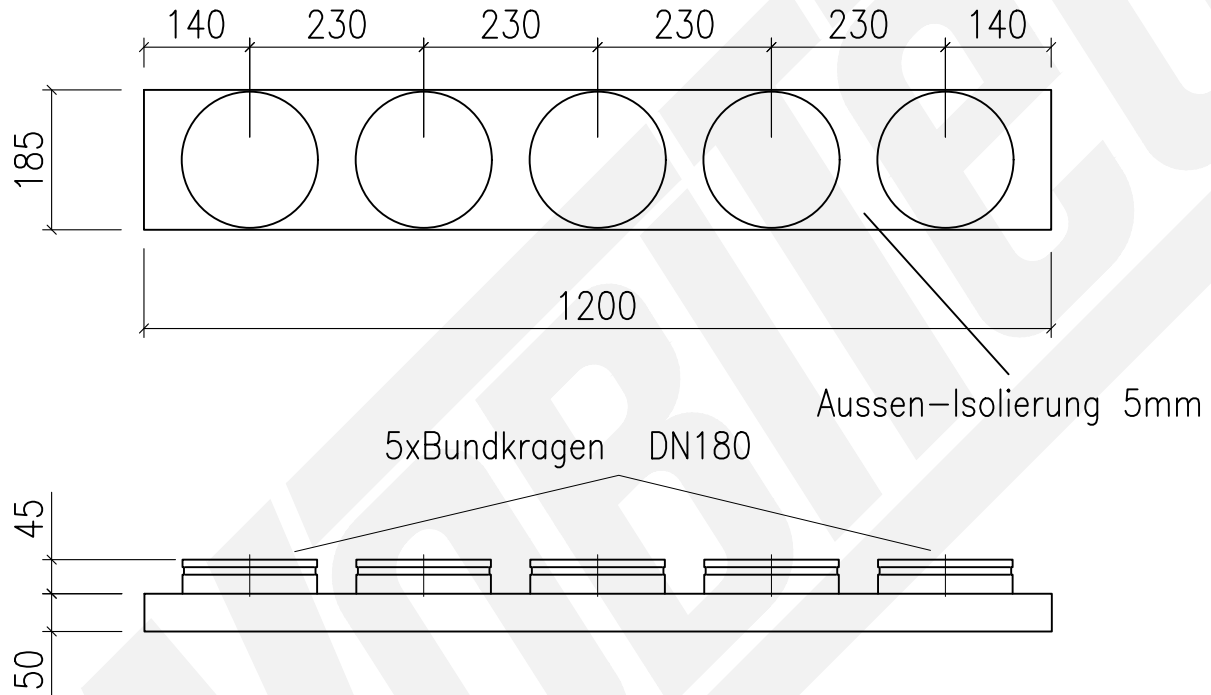

Kanalgerät					
Artikel	Modell	Gerätemaß H-B-L, mm	Druckseite	Saugseite	Luftmenge max. 150Pa
11792	FBA100	245-1400-620	178x1192K	210x1354K	2040 m³/h
11793	FBA125				
11794	FBA140				

	2040	m³/h
5	200	Ø
	3,61	m/s

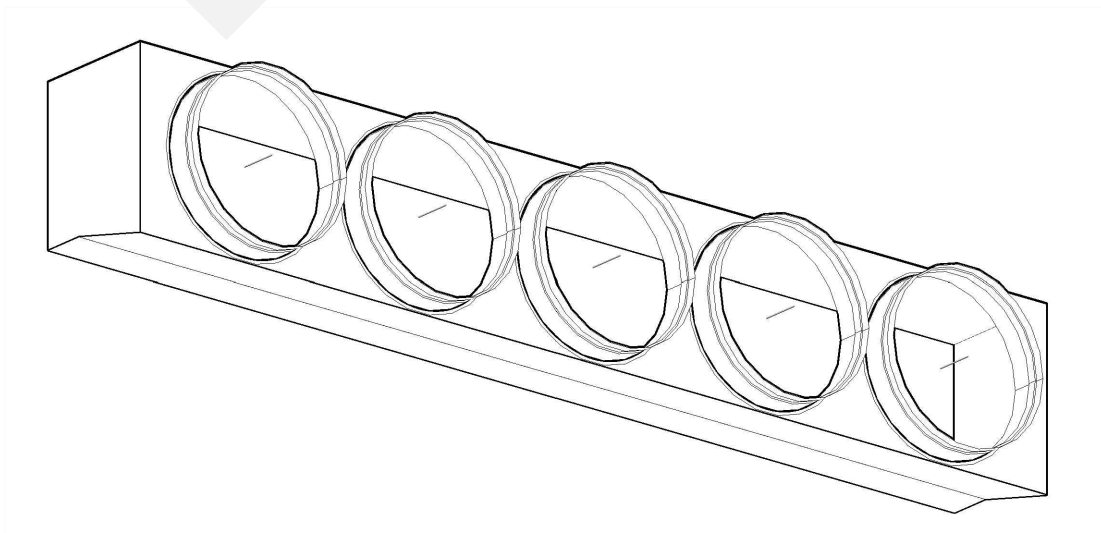
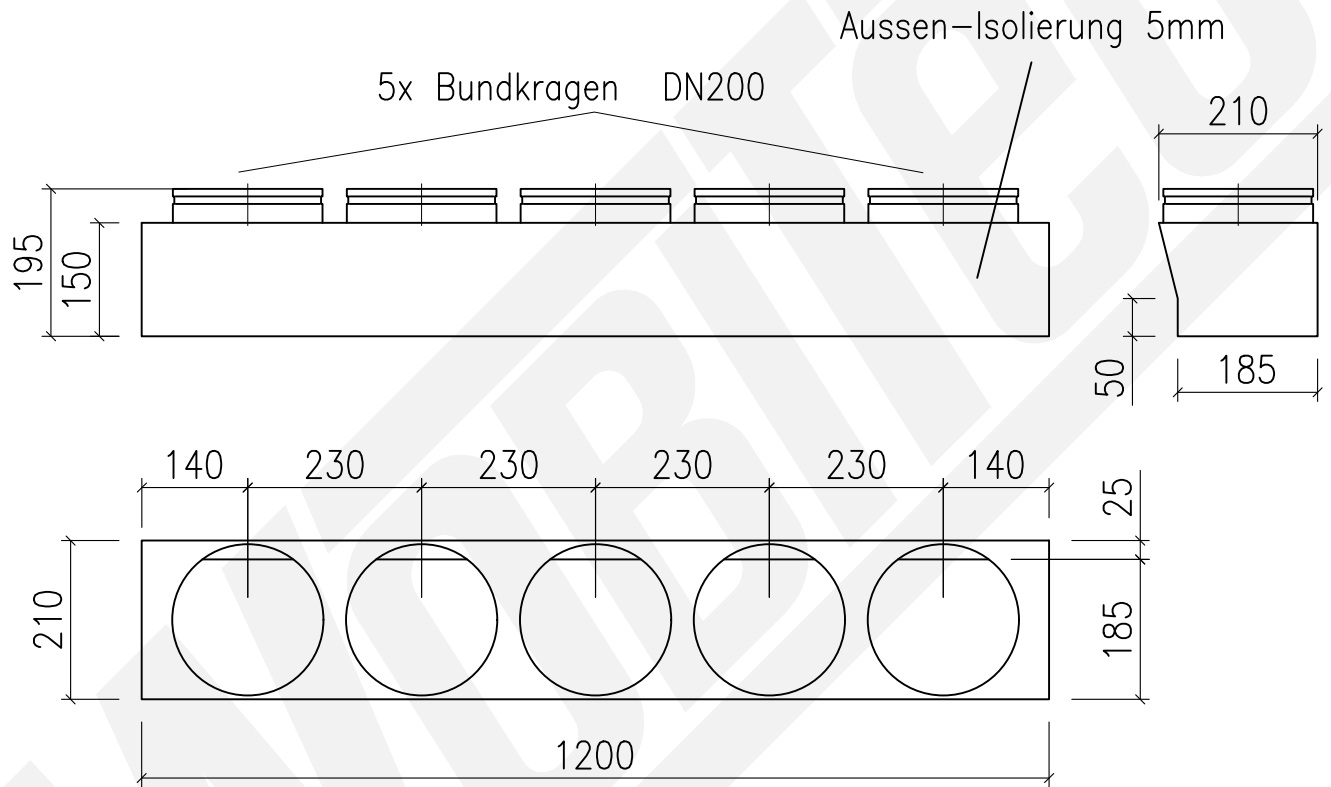

Kanalgerät					
Artikel	Modell	Gerätemaß H-B-L, mm	Druckseite	Saugseite	Luftmenge max. 150Pa
11792	FBA100	245-1400-620	178x1192K	210x1354K	2040 m³/h
11793	FBA125				
11794	FBA140				

Lüftungsgitter				
Modell	Anschluss- maß ,mm		Luft- geschw	Luftmenge m³/h
	ohne Einbaurahmen	mit Einbaurahmen		
IB-Q-425 x 225	420 x 220	425 x 225	2.0 m/c	580
IB-Q-625 x 225	620 x 220	625 x 225		870
IB-Q-825 x 225	820 x 220	825 x 225		1150
IB-Q-1025 x 225	1020 x 220	1025 x 225		1450
IB-Q-1225 x 225	1220 x 220	1225 x 225		1740

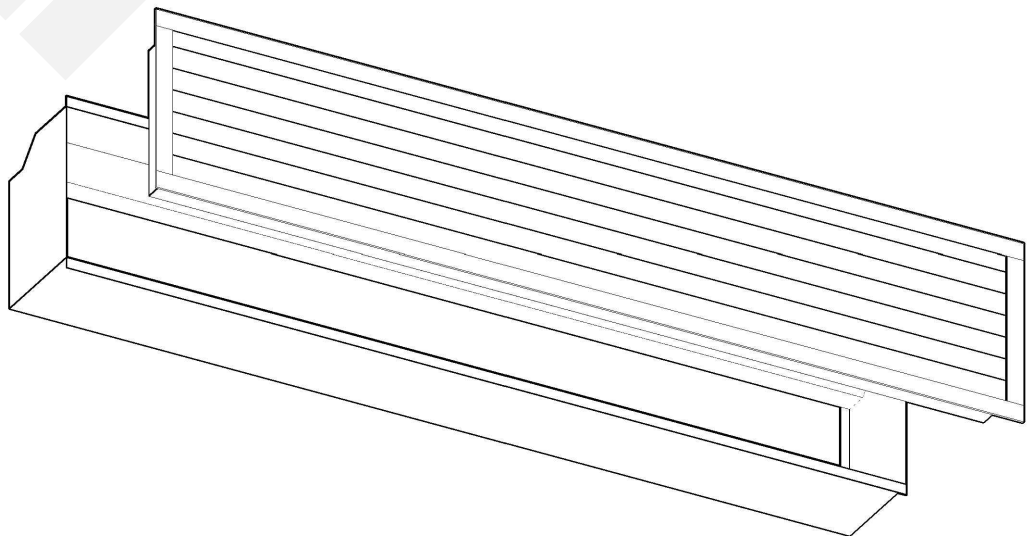
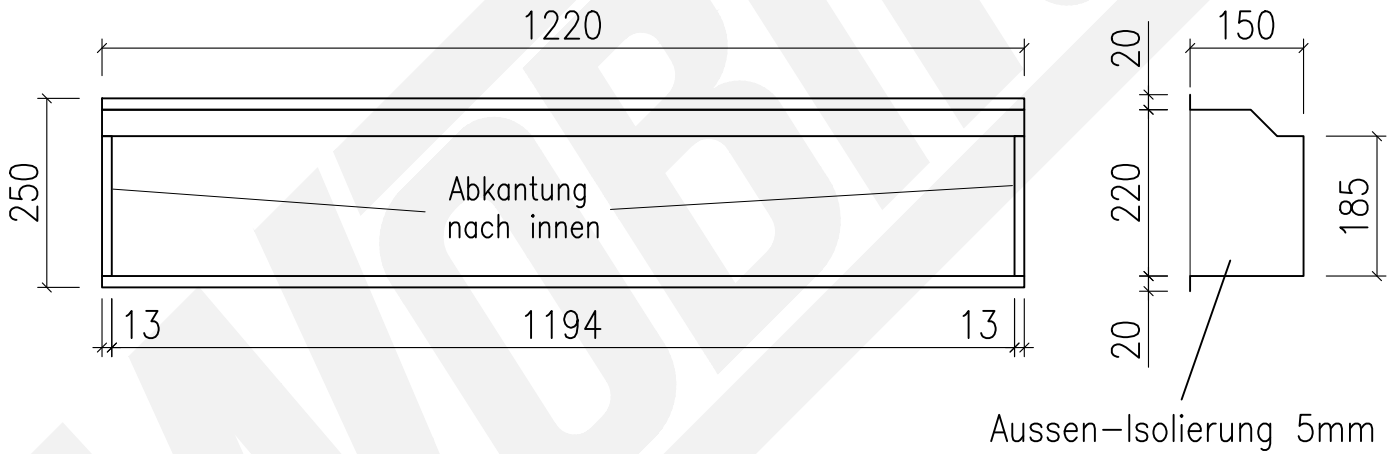

Kanalgerät					
Artikel	Modell	Gerätemaß H-B-L, mm	Druckseite	Saugseite	Luftmenge max. 150Pa
11792	FBA100	245-1400-620	178x1192K	210x1354K	2040 m³/h
11793	FBA125				
11794	FBA140				

	2040	m³/h
5	180	Ø
	4,45	m/s

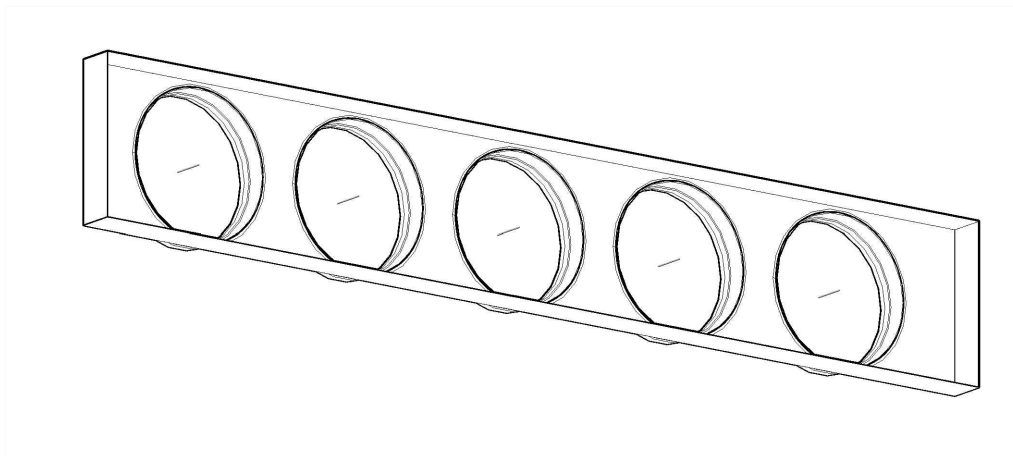
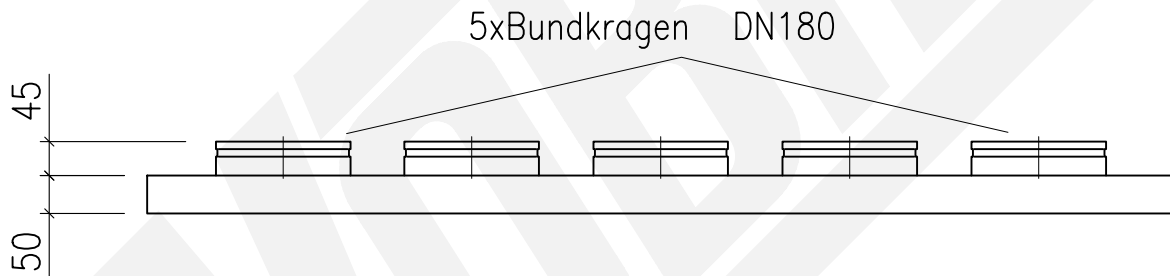
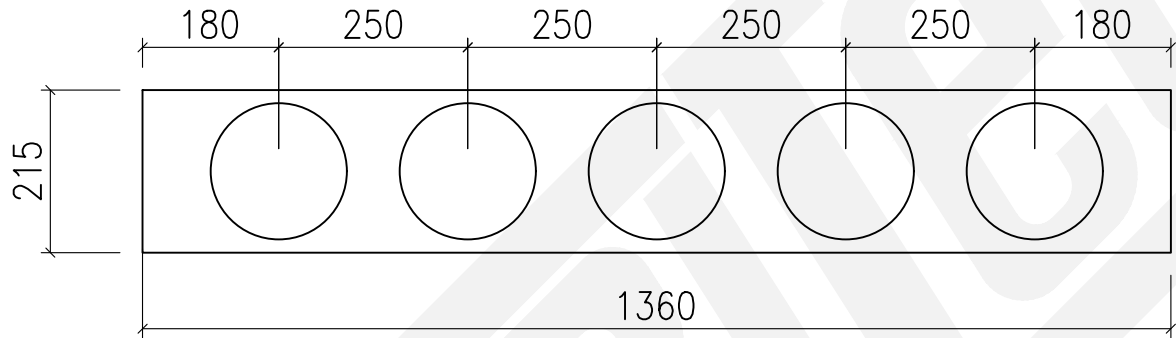

Kanalgerät					
Artikel	Modell	Gerätemaß H-B-L, mm	Druckseite	Saugseite	Luftmenge max. 150Pa
11792	FBA100	245-1400-620	178x1192K	210x1354K	2040 m³/h
11793	FBA125				
11794	FBA140				

	2040	m³/h
5	200	Ø
	3,61	m/s

