

# Air conditioner

---

## Installation manual

---

AR\*\*TXFY\*\*\* / AR\*\*TXHZ\*\*\*

---

- Thank you for purchasing this Samsung air conditioner.
- Before operating this unit, please read this installation manual carefully and retain it for future reference.



**SAMSUNG**

# Contents

---

<b>Safety Information</b>	<b>3</b>
Safety Information	3
<b>Installation</b>	<b>7</b>
Preparation	7
Step 1-1 Viewing the typical installation	7
Step 1-2 Choosing the installation location	8
Step 1-3 Unpacking	11
Step 1-4 Preparing materials and tools	12
<b>Indoor Unit Installation</b>	<b>14</b>
Step 2-1 Attaching the mounting bracket to the wall	14
Step 2-2 Drilling the wall penetration	14
Step 2-3 Connecting the refrigerant pipes	15
Step 2-4 Connecting the power and communication cables	16
Step 2-5 Optional: Extending the power cable	17
Step 2-6 Connecting the drain hose	19
Step 2-7 Taping the pipes, cables, and drain hose	20
<b>Outdoor Unit Installation</b>	<b>21</b>
Step 3-1 Mounting the outdoor unit	21
Step 3-2 Connecting the cables and the pipes	22
<b>Installation Inspection and Testing</b>	<b>24</b>
Step 4-1 Performing a drain leak test	24
Step 4-2 Performing the gas leak tests	24
Step 4-3 Evacuating the system	25
Step 4-4 Adding refrigerant (if needed)	26
Step 4-5 Important information: regulation regarding the refrigerant used	26
Step 4-6 Preparing the system for commissioning	27
Step 4-7 Commissioning the unit	27
Step 4-8 Performing final checks and trial operation	28
<b>Maintenance Procedures</b>	<b>30</b>
Sub PCB installation(optional)	31

For information on Samsung's environmental commitments and product-specific regulatory obligations, e.g. REACH, WEEE, Batteries, visit : [samsung.com/uk/aboutsamsung/samsungelectronics/corporatecitizenship/data\\_corner.html](https://samsung.com/uk/aboutsamsung/samsungelectronics/corporatecitizenship/data_corner.html)

# Safety Information

## **WARNING: Read This Manual**

- Read and follow all safety information and instructions before installation, use, or maintenance of this appliance. Incorrect installation, use, or maintenance of this appliance can result in death, serious injury, or property damage. Keep these instructions with this appliance. This manual is subject to change. For the latest version, visit [www.samsung.com](http://www.samsung.com).

## Notices and notes

To make you aware of safety messages and highlighted information, we use the following notices and notes throughout this manual:

### **WARNING**

Hazards or unsafe practices that may result in severe personal injury or death.

### **CAUTION**

Hazards or unsafe practices that may result in minor personal injury or property damage.

### **IMPORTANT**

Information of special interest

### **NOTE**

Supplementary information that may be useful



**WARNING: Low burning velocity material (This appliance is filled with R-32.)**



The user and installer guides should be read carefully.



The user and installer guides should be read carefully.



The service guide should be read carefully.

## **WARNING**

The installation and testing of this appliance must be performed by a qualified technician.

- The instructions in this manual are not intended as a substitute for proper training or adequate experience in the safe installation of the appliance.

**Always install the air conditioner in compliance with current local, state, and federal safety standards.**

## General information

- The air conditioner should be used only for the applications for which it has been designed: the indoor unit is not suitable to be installed in areas used for laundry.
- Do not use means to accelerate the defrost operation or to clean, other than those recommended by Samsung.
- Do not pierce or burn.
- Be aware that refrigerants may not contain an odour.

## Installation of the product

- Our units must be installed in compliance with the spaces indicated in the installation manual to ensure either accessibility from both sides or ability to perform routine maintenance and repairs. The units' components must be accessible and that can be disassembled in conditions of complete safety either for people or things. For this reason, where it is not observed as indicated into the Installation Manual, the cost necessary to reach and repair the unit (in safety, as required by current regulations in force) with slings, trucks, scaffolding or any other means of elevation won't be considered in-warranty and will be charged to end user.
- The outdoor unit shall be installed in an open space that is always ventilated.
- The local gas regulations shall be observed.
- To handle, purge, and dispose the refrigerant, or break into the refrigerant circuit, the worker should have a certificate from an industry-accredited authority.
- Do not install the indoor unit in the following areas:
  - Area filled with minerals, splashed oil, or steam. It will deteriorate plastic parts, causing failure or leakage.
  - Area that is close to heat sources.
  - Area that produces substances such as sulfuric gas, chlorine gas, acid, and alkali. It may cause corrosion of the pipings and brazed joints.

# Safety Information

- Area that can cause leakage of combustible gas and suspension of carbon fibers, flammable dust, or volatile flammables.
- Area where refrigerant leaks and settles.
- Area where animals may urinate on the product. Ammonia may be generated.
- Do not use the indoor unit for preservation of food items, plants, equipment, and art works. This may cause deterioration of their quality.
- Do not install the indoor unit if it has any drainage problem.
- For the multi system, this indoor unit can be connected to an R-32 or R-410A outdoor unit. Check the type of refrigerant in the outdoor unit.
- Because your air conditioner contains R-32 refrigerant, make sure that it is installed, operated, and stored it in a room whose floor area is larger than the minimum required floor area specified in the following table:

Wall-mounted type	
m (kg)	A (m <sup>2</sup> )
≤1.842	No requirement
1.843	4.45
1.9	4.58
2.0	4.83
2.2	5.31
2.4	5.79
2.6	6.39
2.8	7.41
3.0	8.51

- m : Total refrigerant charge in the system
- A : Minimum required floor area
- **IMPORTANT:** it's mandatory to consider either the table above or taking into consideration the local law regarding the minimum living space of the premises.
- Minimum installation height of indoor unit is 0.6 m for floor mounted, 1.8 m for wall, 2.2 m for ceiling.

## Installation of the outdoor unit

- While in installation or relocation of the product, do not mix the refrigerant with other gases including air or unspecified refrigerant. Failure to do so may cause pressure increase to result in rupture or injury.
- Do not cut or burn the refrigerant container or pipings.

- Use clean parts such as manifold gauge, vacuum pump, and charging hose for the refrigerant.
- Installation must be carried out by qualified personnel for handling the refrigerant. Additionally, reference the regulations and laws.
- Be careful not to let foreign substances (lubricating oil, refrigerant, water, etc.) enter the pipings. The application of oil or refrigerant deteriorates the pipings to result in drain leakage. For storage, securely seal their openings.
- When mechanical ventilation is required, ventilation openings shall be kept clear of obstruction.
- For disposal of the product, follow the local laws and regulations.
- Do not work in a confined place.
- The work area shall be blocked.
- The refrigerant pipings shall be installed in the position where there are no substances that may result in corrosion.
- The following checks shall be performed for installation:
  - The charging amount depends on the room size.
  - The ventilation devices and outlets are operating normally and are not obstructed.
  - Markings and signs on the equipment shall be visible and legible.
- Upon leakage of the refrigerant, ventilate the room. When the leaked refrigerant is exposed to flame, it may cause generation of toxic gases.
- Make sure that the work area is safe from flammable substances.
- To purge air in the refrigerant, be sure to use a vacuum pump.
- Note that the refrigerant has no odour.
- The units are not explosion proof so they must be installed with no risk of explosion.
- This product contains fluorinated gases that contribute to global greenhouse effect. Accordingly, do not vent gases into the atmosphere.
- Because the working pressure for R-32 is 1.6 times higher than that for R-22, use exclusive pipings and tools specified. In case of replacing an R-22 model with an R-32 model, be sure to replace the conventional pipings and flare nuts with exclusive ones.
- The models that use the refrigerant R-32 have a different thread diameter for the charging port to prevent charging failure. Therefore, check its diameter (12.70 mm) in advance.

- Servicing shall be performed as recommended by the manufacturer. In case other skilled persons are joined for servicing, it shall be carried out under supervision of the person who is competent in handling flammable refrigerants.
- For servicing the units containing flammable refrigerants, safety checks are required to minimise the risk of ignition.
- Servicing shall be performed following the controlled procedure to minimize the risk of flammable refrigerant or gases.
- Do not install where there is a risk of combustible gas leakage.
- Do not place heat sources.
- Be cautious not to generate a spark as follows:
  - Do not remove the fuses with power on.
  - Do not disconnect the power plug from the wall outlet with power on.
  - It is recommended to locate the outlet in a high position. Place the cords so that they are not tangled.
- If the indoor unit is not R-32 compatible, an error signal appears and the unit will not operate.
- After installation, check for leakage. Toxic gas may be generated and if it comes into contact with an ignition source such as fan heater, stove, and cooker.cylinders, make sure that only the refrigerant recovery cylinders are used.
- Under no circumstances shall potential sources of ignition be used while in detection of leakage.
- Make sure that the seals or sealing materials have not degraded.
- Safe parts are the ones with which the worker can work in a flammable atmosphere. Other parts may result in ignition due to leakage.
- Replace components only with parts specified by Samsung. Other parts may result in the ignition of refrigerant in the atmosphere from a leak.

## Area ventilation

- Make sure that the work area is well ventilated before performing a hot work.
- Ventilation shall be made even during the work.
- The ventilation should safely disperse any released gases and preferably expel them into the atmosphere.

## Leakage detection methods

- The leakage detector shall be calibrated in a refrigerant-free area.
- Make sure that the detector is not a potential source of ignition.
- The leakage detector shall be set to the LFL (lower flammability limit).
- The use of detergents containing chlorine shall be avoided for cleaning because the chlorine may react with the refrigerant and corrode the pipings.
- If leakage is suspected, naked flames shall be removed.
- If a leakage is found while in brazing, the entire refrigerant shall be recovered from the product or isolated (e.g. using shut-off valves). It shall not be directly released to the environment. Oxygen free nitrogen (OFN) shall be used for purging the system before and during the brazing process.
- The work area shall be checked with an appropriate refrigerant detector before and during work.
- Ensure that the leakage detector is appropriate for use with flammable refrigerants.

## Preparation of fire extinguisher

- If a hot work is to be done, an appropriate fire extinguishing equipment should have been available.
- A dry powder or CO<sub>2</sub> fire extinguisher shall be equipped near the charging area.

## Ignition sources free

- Make sure to store the units in a place without continuously operating ignition sources (for example, open flames, an operating gas appliance or an operating electric heater).
- The service engineers shall not use any ignition sources with the risk of fire or explosion.
- Potential ignition sources shall be kept away from the work area where the flammable refrigerant can possibly be released to the surrounding.
- The work area should be checked to ensure that there are no flammable hazards or ignition risks. The "No Smoking" sign shall be attached.

## Labelling

- The parts shall be labelled to ensure that they have been decommissioned and emptied of refrigerant.
- The labels shall be dated.

# Safety Information

---

- Make sure that the labels are affixed on the system to notify it contains flammable refrigerant.
- Never install a motor-driven equipment to prevent ignition.

## Recovery

---

- When removing refrigerant from the system for servicing or decommissioning, it is recommended to remove the entire refrigerant.
- When transferring refrigerant into cylinders, make sure that only the refrigerant recovery cylinders are used.
- All cylinders used for the recovered refrigerant shall be labelled.
- Cylinders shall be equipped with pressure relief valves and shut-off valves in a proper order.
- Empty recovery cylinders shall be evacuated and cooled before recovery.
- The recovery system shall operate normally according to the specified instructions and shall be suitable for refrigerant recovery.
- In addition, the calibration scales shall operate normally.
- Hoses shall be equipped with leak-free disconnect couplings.
- Before starting the recovery, check for the status of the recovery system and sealing state. Consult with the manufacturer if suspected.
- The recovered refrigerant shall be returned to the supplier in the correct recovery cylinders with the Waste Transfer Note attached.
- Do not mix refrigerants in the recovery units or cylinders.
- If compressors or compressor oils are to be removed, make sure that they have been evacuated to the acceptable level to ensure that flammable refrigerant does not remain in the lubricant.
- The evacuation process shall be performed before sending the compressor to the suppliers.
- Only the electrical heating to the compressor body is allowed to accelerate the process.
- Oil shall be drained safely from the system.
- For installation with handling the refrigerant (R-32), use dedicated tools and piping materials. Because the pressure of the refrigerant, R-32 is approximately 1.6 times higher than that of R-22, failure to use the dedicated tools and piping materials may cause rupture or injury. Furthermore, it may cause serious accidents such as water leakage, electric shock, or fire.

## Power supply line, fuse, or circuit breaker

---

- Be sure not to perform power cable modification, extension wiring, and multiple wire connection.
  - It may cause electric shock or fire due to poor connection, poor insulation, or current limit override.
  - When extension wiring is required due to power line damage, refer to "Step 2-5 Optional: Extending the power cable" in the installation manual.

# Preparation

## Step 1-1 Viewing the typical installation

A typical installation will be similar to the one shown below.

Evaporator/fancoil (indoor)

Maximum pipe height

Maximum pipe length

Refrigerant lines, electric, and drain

Compressor/condenser (outdoor)

Make at least one round to reduce noise and vibration.

The actual units may look different from the images depicted here.

(Unit : m)

Model	Pipe length			Pipe height
	Minimum	Maximum	Standard for factory charge	Maximum
**07*****	3	15	5	8
**09*****				
**12*****				

Outdoor Unit

Outer wall

Indoor Unit

Cut insulation to have rainwater drained

**CAUTION**

Make a U-trap (A) on the pipe (which is connected to the indoor unit) at outer wall and cut the bottom part of the insulation (about 10 mm) to prevent rainwater from getting inside through the insulation.

### **CAUTION**

- For the product that uses the R-32 refrigerant, Install the indoor unit on the wall 1.8 m or higher from the floor.

# Preparation

## Step 1-2 Choosing the installation location

If using a multi system, install as described in the installation manual supplied with the outdoor unit.

### WARNING

- Verify that a dedicated circuit breaker and a disconnect switch of the appropriate sizes for the air conditioner are preinstalled and available for use.
- Verify that the voltage and frequency of the power supply comply with the rated voltage as defined on the unit name plate.
- Verify that a suitable grounding connection is available.
- Do not install this appliance in an environment containing hazardous substances or close to equipment that releases open flames.
- Do not install this appliance near a heater or flammable material.

### CAUTION

- The manufacturer shall not be responsible for damage occurring as a result of the wrong voltage being applied to this air conditioner.
- The indoor and outdoor units must be installed in compliance with minimum clearances to ensure that both units are accessible from both sides and can be maintained or repaired. Insufficient clearance may reduce product performance, generate excessive noise, and reduce the life of some unit components.

### IMPORTANT

- Any changes or modifications to the installation described in this manual that are not expressly approved by the manufacturer could void the manufacturer's warranty.

To determine where to locate the indoor and outdoor units, you must survey the entire site and consider many variables. The goal is to select locations that comply with all safety precautions while also minimizing the total effort involved.

## Indoor unit location requirements

### WARNING

- Do not install the unit in a humid, oily, or dusty location or in a location exposed to direct sunlight, water, or rain.
- Make sure that the wall can support the unit weight.

Examine the area that the customer wants to be air conditioned. Consider the following:

- What wall location will meet minimum clearances and provide optimal product performance?
- Will the wall provide adequate support for the unit weight (wall with stud construction or concrete)? If applicable, where are the studs?
- Where will you place the wall penetration for routing the piping bundle (consisting of power and communication cables, refrigerant pipes, and the drain hose) through the wall to the outdoor unit? Will the hole intersect any plumbing or wires in the wall?
- Is the location as close as possible to where the outdoor unit will be installed, to minimize the length of piping and cables?
- Will the condensate drain inside the room, through the wall penetration to the outdoor unit, or be connected to a condensate pump?

### NOTE

- This manual covers a typical gravity-drain installation where the drain hose is routed to the outdoor unit through a hole in the wall.

## Minimum clearances for the indoor unit

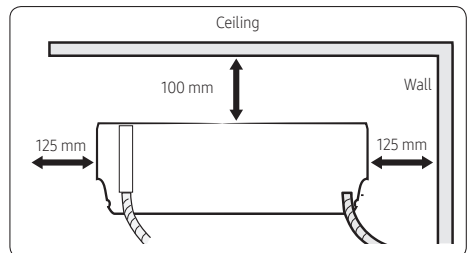



## Outdoor unit location requirements

Examine the area where the outdoor unit could be located. Consider the following:

- What location will meet minimum clearances and provide optimal product performance?
- Is there an existing level and hard foundation, such as a concrete pad, that will support the unit weight and produce minimal vibration? Installation on uneven ground may result in abnormal vibrations, noise, or problems with the unit.
- Does the unit need to be mounted on the wall?
- Where are the dedicated circuit breaker and disconnect switch located? How will you connect them to the unit?
- How will you route the piping bundle from the indoor unit? Is the location as close as possible to where the indoor unit will be installed, to minimize the length of piping and cables?
- Will the unit be sheltered from the wind? In a high-wind area, you may need to build a protective fence around the unit.
- Where will the condensate drain?



### WARNING

- The drain location must allow condensate to drain properly and prevent ice from forming on the unit in winter. If a block of ice falls from the unit, it may result in death, serious injury, or property damage. Improper or inadequate draining may result in water overflowing and property damage.



### CAUTION

- Do not connect the drain hose to existing waste pipes as odors may arise.

### Installation on an exterior wall

If the outdoor unit must be installed on an exterior wall, you will need an L-bracket to support the unit. This bracket is not included with the unit.



### WARNING

- The wall must be capable of supporting the weight of both the L-bracket and the outdoor unit. If the unit falls, it may result in crushing, electric shock, fire, or explosion that could cause death, severe personal injury, or property damage.

## Installation Guide at the seashore

Make sure to follow below guides when installing at the seashore.

- 1 Do not install the product in a place where it is directly exposed to sea water and sea breeze.
  - Make sure to install the product behind a structure (such as building) that can block sea breeze.
  - Even when it is inevitable to install the product in seashore, make sure that product is not directly exposed to sea breeze by installing a protection wall.
- 2 Consider that the salinity particles clinging to the external panels should be sufficiently washed out.
- 3 Because the residual water at the bottom of the outdoor unit significantly promotes corrosion, make sure that the slope does not disturb drainage.
  - Keep the floor level so that rain does not accumulate.
  - Be careful not to block the drain hole due to foreign substance.
- 4 When product is installed in seashore, periodically clean it with water to remove attached salinity.
- 5 Make sure to install the product in a place that provides smooth water drainage. Especially, ensure that the base part has good drainage.
- 6 If the product is damaged during the installation or maintenance, make sure to repair it.
- 7 Check the condition of the product periodically.
  - Check the installation site every 3 months and perform anti-corrosion treatment such as R-Pro supplied by SAMSUNG (Code : MOK-220SA) or commercial water repellent grease and wax, etc., based on the product condition.
  - When the product is to be shut down for a long period of time, such as off-peak hours, take appropriate measures like covering the product.
- 8 If the product installed within 500m of seashore, special anti-corrosion treatment is required.
  - ※ Please contact your local SAMSUNG representative for further details.

# Preparation

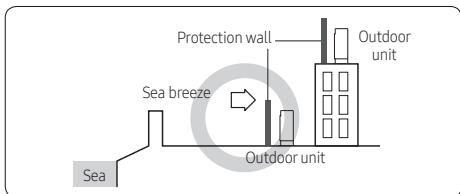
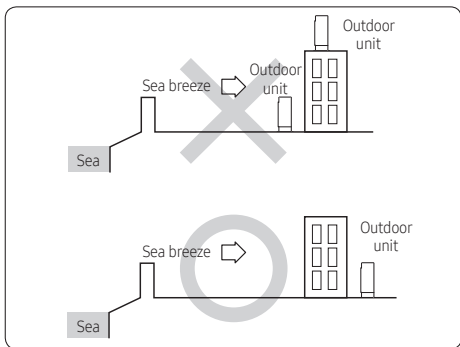

- Protection wall should be constructed with a solid material that can block the sea breeze and the height and width of the wall should be 1.5 times larger than the size of the outdoor unit. (You must secure more than 700 mm of space between the protection wall and the outdoor unit for air circulation.)

## Minimum clearances for the outdoor unit

Legends:

Wall
Minimum clearance in mm
Air flow direction
<div style="display: flex; justify-content: space-around; width: 100%;"> <span>Top view</span> <span>Side view</span> </div>

## Examples for installing one outdoor unit:

Unit: mm

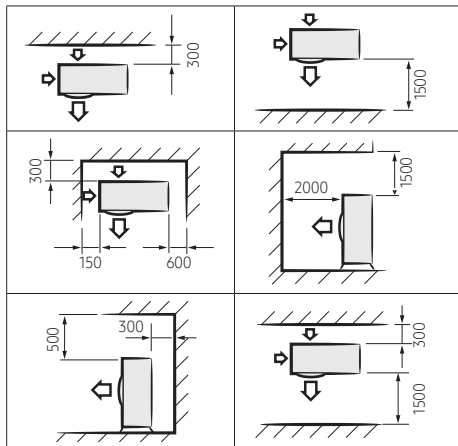

## Examples for installing multiple outdoor units:

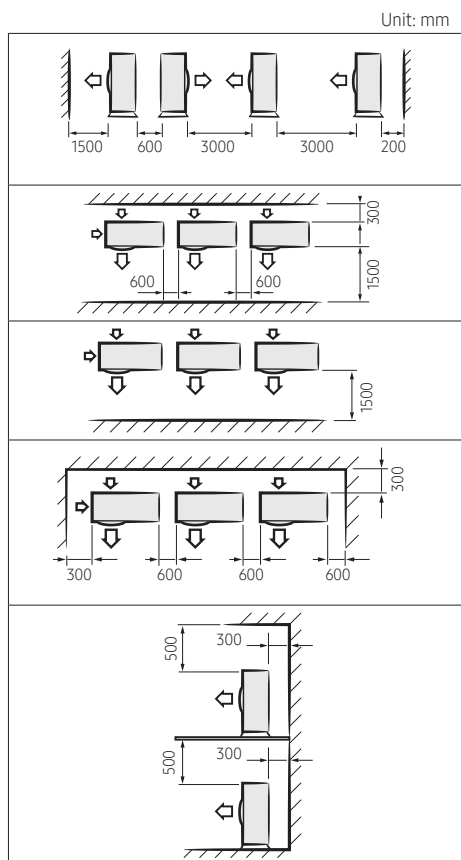

## Step 1-3 Unpacking

Upon receipt, inspect the product to verify that it has not been damaged during transport. If the product appears damaged, do not install it and immediately report the damage to your local Samsung distributor.

Packing material must be disposed of in accordance with local regulations.

### Unpacking the indoor unit

At the selected indoor unit location:

- 1 Open the indoor unit package.
- 2 Remove the left and right cushions.
- 3 Carefully remove the unit from the package.
- 4 Place the unit on a flat surface where it will be protected from possible damage.

### Unpacking the outdoor unit

At the selected outdoor unit location:







- 1 Remove the package.
- 2 Remove the top cushion.
- 3 Carefully remove the unit from the bottom cushion.
- 4 Place the unit on a flat surface where it will be protected from possible damage.

# Preparation

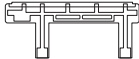
## Step 1-4 Preparing materials and tools



### Materials in the indoor unit package

Make sure that the indoor unit package contains the following materials:

<b>Mounting bracket (1)</b> **07***** **09***** **12*****	<b>Remote control (1)</b>
	
<b>Remote control battery (2)</b>	<b>General information (1)</b>
	
<b>Quick guide (1)</b>	<b>Installation manual (1)</b>
	











### Materials in the outdoor unit package

Make sure that the outdoor unit package contains the following materials:

<b>Rubber foot (4)</b>	<b>Drain plug (1)</b>
	

If using a multi system, refer to the manual supplied with the outdoor unit.

### Optional accessories

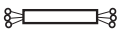
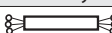
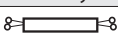
<b>Insulated assembly pipe, Ø 6.35 mm (1)</b>	<b>Insulated assembly pipe, Ø 9.52 mm (1)</b> **09***** **12*****
	
<b>Pipe clamp B (3)</b>	<b>Pipe clamp A (3)</b>
	
<b>Drain Hose, 2 m long (1)</b>	<b>Foam Insulation (1)</b>
	
<b>Vinyl tape (2)</b>	<b>PE T3 foam tube insulation (1)</b>
	
<b>Putty 100 g (1)</b>	<b>M4 x 25 tapped screw (6)</b>
	
<b>Cement nail (6)</b>	<b>3-wire Power Cable (1)</b>
	
<b>3-wire Assembly Cable (1)</b>	<b>2-wire Assembly Cable (1)</b>
	

#### NOTE

- A flare nut is attached to the end of each refrigerant pipe coming from the evaporator. Use these flare nuts when connecting the pipes.

---

## Materials supplied by the installer

---

Make sure you have all other materials required for the selected installation method and location.

### IMPORTANT

- No mounting hardware, tubing, cables, and other materials listed below are included with the appliance.

The required materials will vary, but may include the following:

- 1.8 m electrical whip for connecting the power from the installed disconnect switch to the outdoor unit
- UV-resistant vinyl line set tape for the exposed line set
- Lines-set cover and fittings, if used
- Miscellaneous pipe hangers
- Miscellaneous screws and anchors for hanging pipe hangers, the line-set cover, the indoor unit mounting bracket, and so on.
- Electrical ring connectors for connecting all power and communication wiring
- Electrical tape
- Refrigerant R-32 if additional refrigerant is required due to line-set length
- Closed cell foam tape insulation (roll)
- Outdoor unit risers or L-brackets for wall installation
- Silicone caulking for sealing the wall penetration
- Rags

## Tools

---

Make sure you have the required tools available.

### General tools

- Vacuum pump (Backward flowing prevention)
- Manifold gauge
- Stud finder
- Torque wrench
- Pipe cutter
- Reamer
- Pipe bender
- Spirit level
- Screwdriver
- Spanner
- Drill
- L-wrench
- Measuring tape

### Tools for test operation

- Thermometer
- Resistance meter
- Electroscopes

# Indoor Unit Installation

## Step 2-1 Attaching the mounting bracket to the wall

- 1 Hold the mounting bracket against the wall at the selected installation position (Step 1-2 on page 8), making sure that the screw holes align with the center of the studs in the wall. If the screw locations do not align with the studs, use wall anchors.

### CAUTION

- The recommended best practice is to attach the mounting bracket directly to the studs in the wall. If you did not find a suitable location with studs (in Step 1-2 on page 8), or if the wall is concrete, you must use wall anchors of a suitable type and weight capacity, and install them according to the manufacturer's instructions. Failure to do so may cause the material surrounding the joints to crumble over time and the screws to be loosened and stripped. This may result in the unit falling from the wall, which could cause physical injury or equipment damage.
- 2 Using a level, make sure that the mounting bracket is level, then mark the location of the screw holes on the wall.
  - 3 If using wall anchors, install them at the screw hole positions, following the manufacturer's instructions.
  - 4 Using six field-supplied mounting screws and anchors (if applicable), attach the bracket to the wall.

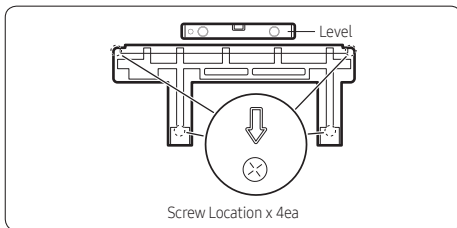

## Step 2-2 Drilling the wall penetration

- 1 Determine the position of the hole through which the piping bundle (consisting of power and communication cables, refrigerant pipes, and the drain hose) will pass. Consider the following:
  - The hole inner diameter must be 65 mm.
  - The recommended hole location is behind the unit so that the hole and the piping bundle will not be visible in the room. The minimum distances between the hole and the mounting bracket are:

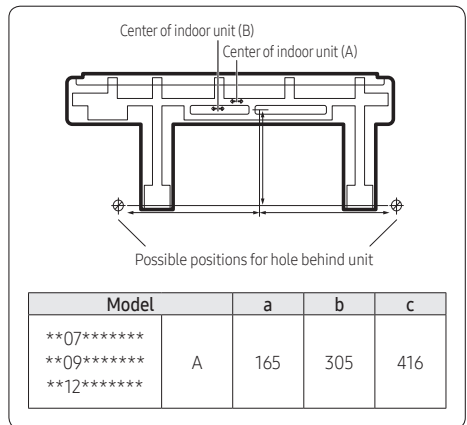

- If the hole cannot be positioned behind the unit, find a position as close to the unit as possible. The piping bundle that exits the unit and extends to the hole will need to be attached to the wall and will be visible inside the room.
- In relation to the bracket shown above, the unit is shipped with the drain hose connection on the right, the drain hose exits the unit on the left, and the refrigerant pipes are bent to exit on the left. Thus, positioning the hole to the left requires the least effort. If you position the hole to the right or below the unit, you will need to move the drain hose connection to the left and bend the pipes so that the hose and pipes exit to the right or bottom. See the figure in step 3 on page 15.

- Use a standard 65 mm hole saw to drill one hole at the selected location, at a 15° downward angle so that the drain hose will drain properly.

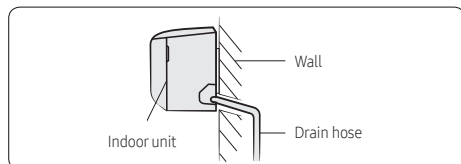

- Based on the hole location, determine where the piping bundle (drain hose, refrigerant pipes, and cables) will exit the unit.

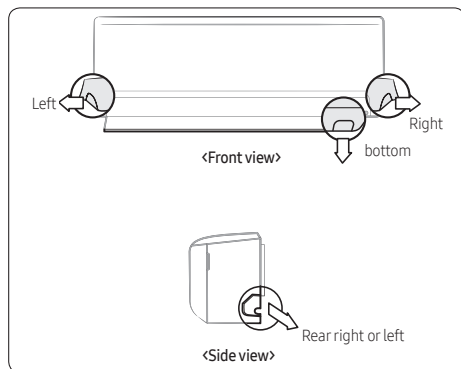

#### NOTE

- The left, right, or bottom exit will only be used if the hole is not positioned behind the unit.

## Step 2-3 Connecting the refrigerant pipes

Connect indoor and outdoor units with field-supplied copper pipes by means of flare connections. Use insulated seamless refrigeration grade pipe only, (Cu DHP type according to ISO1337), degreased and deoxidized, suitable for operating pressures of at least 4200 kPa and for burst pressure of at least 20700 kPa. Under no circumstances must sanitary type copper pipe be used.

#### IMPORTANT

- When installing the unit, always connect the refrigerant pipes first, followed by the electrical cables. For disassembly, always disassemble the electric cables before the refrigerant pipes.

Two short refrigerant pipes are already attached to the air conditioner:

- The smaller-diameter pipe is for the high-pressure, two-phase refrigerant.
- The larger-diameter pipe is for the low-pressure refrigerant vapor.

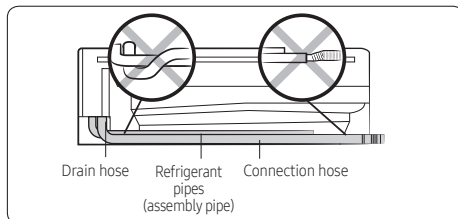

In Step 2-2, step 3 you determined the exit position for the piping bundle. The unit has three knockouts available for the left, right, and bottom exits. When the bundle exits directly from the rear, none of the knockouts are used.

- If the pipes will exit directly from the rear, skip to step 3. Otherwise, cut out the appropriate knockout piece (left, right, or bottom).
- Use a razor knife to clean the cut edges (flashing).
- The left exit is the only position that does not require bending the pipes. For other positions, bend the pipes so that they will exit in the selected exit position.

- The bending radius should be greater than 100 mm.
- Bend the smaller pipe gradually to prevent kinking. The larger pipe has a preinstalled spring bender to prevent kinking.
- Make sure that the pipes do not protrude from the back of the unit in a way that will make it difficult to attach the unit to the mounting bracket.
- For right and bottom exits, pull the pipes out through the selected knockout opening. For left exits, the piping connections will be made in the service space behind the indoor unit (under the cover panel).

#### NOTE

- If you are using the right rear exit, the pipes should be long enough to extend through the wall without needing to connect the line set first. It may be easier to connect the line set outside of the building, after you have bundled the pipes and cables and passed the bundle through the wall. In this case, do not connect the line set now. Instead, complete Step 2-4 through Step 2-7, then go outside and connect the line set as described below.

# Indoor Unit Installation

- Slowly remove the protective caps on the refrigerant pipe connections to relieve the nitrogen holding charge.
- Connect the line set to each pipe.

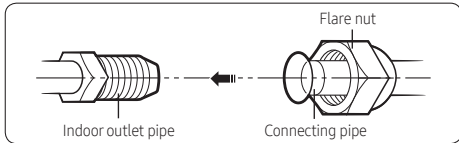

- Hand-tighten the flare nuts to make sure that they do not become stripped.

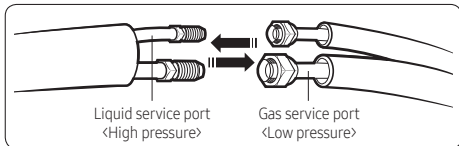

- Torque the flare connections to the following values:

Outer diameter (mm)	Torque (N·m)
ø 6.35	14–18
ø 9.52	34–42
ø 12.70	49–61
ø 15.88	68–82

## CAUTION

- Tighten the flare nuts only to the specified torque. If a flare nut is overtightened, the flare face may crack, causing refrigerant leakage.
- Do not box in or cover the pipe connections. Make sure that the connections are accessible for testing later in the installation process and for future servicing.
  - Tape over the end of the pipes so that debris will not enter the piping when it is passed through the wall. The pipes will be insulated later in the installation process.

## Step 2-4 Connecting the power and communication cables

If using a multi system, install as described in the installation manual supplied with the outdoor unit.

### WARNING

- Do not modify the power cable in any way. Doing so may cause electric shock or fire due to poor connection, poor insulation, or current limit override. Make sure to comply with the technical standards of electrical installations and the wiring regulations in the local area.
- This appliance must be properly grounded. Do not ground the appliance to a gas pipe, plastic water pipe, or telephone line. Failure to comply may result in electric shock, fire, and explosion.

- Connect each wire to its corresponding terminal number.

Model	**07***** **09***** **12*****
Power cable (Outdoor unit)	3G X 2.5 mm <sup>2</sup> , H07RN-F
Outdoor-to-indoor power cable	3G X 1.0 mm <sup>2</sup> , H07RN-F
Communication cable	2 X 0.75 mm <sup>2</sup> , H05RN-F
Type GL	16A

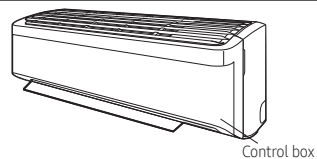

Before connecting				
	Correct	Upside down	Damaged	Non-circular
After connecting				
	Correct (Front view)	Correct (Side view)	Upside down	Non-fitted

<Circular terminal>



## CAUTION

- Connect the wires firmly so that wires cannot be pulled out. Loose wires can cause the connection to overheat.

Each circular terminal must match the size of its corresponding screw in the terminal block.

## CAUTION

- For the terminal block wiring, use a wire with a ring terminal socket only. Regular wires without a ring terminal socket may become a hazard as the connections may loosen during operation.

For the product that uses the R-32 refrigerant, be cautious not to generate a spark by keeping the following requirements:

- Do not remove the fuses with power on.
- Do not disconnect the power plug from the wall outlet with power on.
- It is recommended to locate the outlet in a high position. Place the cords so that they are not tangled.

- 2 Tighten the terminal block screw.

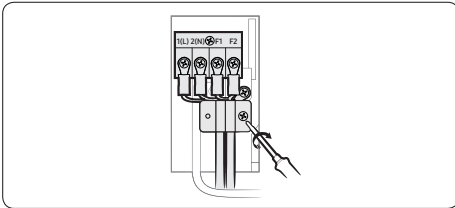





- 3 In Step 2-2, step 3 you determined the exit position for the piping bundle. If using the left, right, or bottom exits, pass the cables through the selected knockout.

## NOTE

- Power supply cords of parts of appliances for outdoor use shall not be lighter than polychloroprene sheathed flexible cord. (Code designation IEC: 60245 IEC66/ CENELEC: H07RN-F, IEC: 60245 IEC57 CENELEC: H05RN-F, IEC: 60227 IEC53: H05VV-F)
- Power & Communication cable shall not exceed 30 m.

## Step 2-5 Optional: Extending the power cable

- 1 Prepare the following tools.

Tools	Spec	Shape
Crimping pliers	MH-14	
Connection sleeve (mm)	20xØ6.5 (HxOD)	
Insulation tape	Width 19 mm	
Contraction tube (mm)	70xØ8.0 (LxOD)	

- 2 As shown in the figure, peel off the shields from the rubber and wire of the power cable.
  - Peel off 20 mm of cable shields from the pre-installed tube.

## CAUTION

- For information about the power cable specifications for indoor and outdoor units, refer to the installation manual.
- After peeling off cable wires from the pre-installed tube, insert a contraction tube.
- If cable wires are connected without using connecting sleeves, their contact area becomes reduced, or corrosion develops on the outer surfaces of the wires (copper wires) over a long time. This may cause an increase of resistance (reduction of passing current) and consequently may result in a fire.

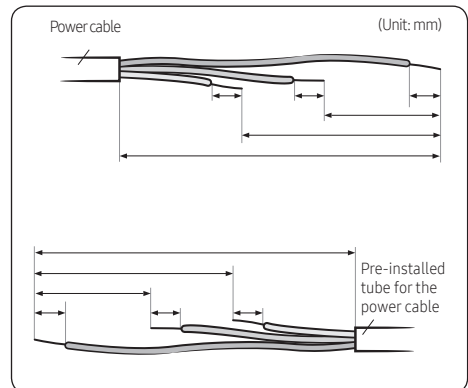

# Indoor Unit Installation

- 3 Insert both sides of core wire of the power cable into the connection sleeve.
- **Method 1:** Push the core wire into the sleeve from both sides.
  - **Method 2:** Twist the wire cores together and push it into the sleeve.

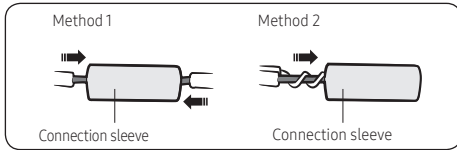

- 4 Using a crimping tool, compress the two points and flip it over and compress another two points in the same location.
- The compression dimension should be 8.0.

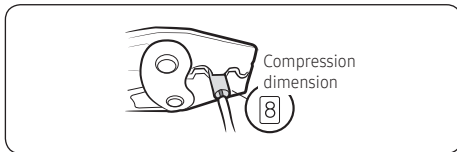

- After compressing it, pull both sides of the wire to make sure it is firmly pressed.

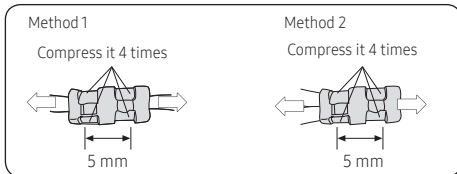

- 5 Wrap it with the insulation tape twice or more and position your contraction tube in the middle of the insulation tape.

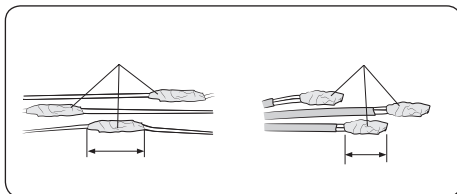

- 6 Apply heat to the contraction tube to contract it.

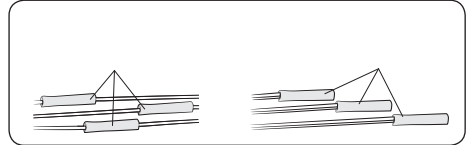

- 7 After tube contraction work is completed, wrap it with the insulation tape to finish. Three or more layers of insulation are required.

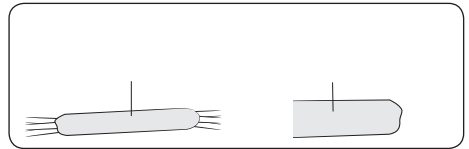

## CAUTION

- Make sure that the connection parts are not exposed to outside.
- Be sure to use insulation tape and a contraction tube made of approved reinforced insulating materials that have the same level of withstand voltage with the power cable. (Comply with the local regulations on extensions.)

## WARNING

- In case of extending the electric wire, please DO NOT use a round-shaped Pressing socket.
  - Incomplete wire connections can cause electric shock or a fire.

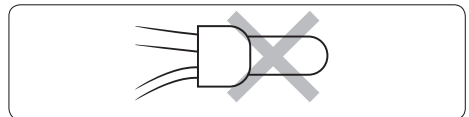

## Step 2-6 Connecting the drain hose

- In Step 2-2, step 3 you determined the exit position for the piping bundle. If using the right, bottom, or right rear exit, change the drain hose connection from the right to the left so that the drain hose will lie along the inside of the unit and exit to the right.

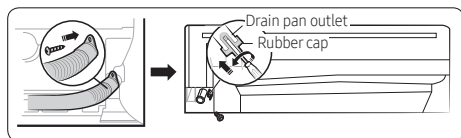

### CAUTION

- Be careful not to puncture the plug with the screwdriver when installing it.
- If using the left, right, or bottom exit, pass the drain hose through the selected knockout.

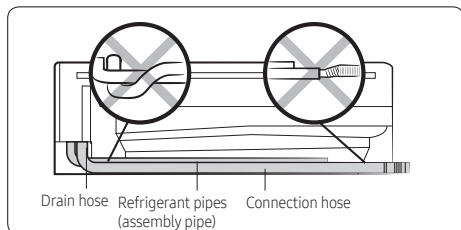

- Connect a 15.88 mm ID extension drain hose to the main drain hose.

### CAUTION

- If the diameter of the connection hose is smaller than the product's drain hose, leakage may occur.

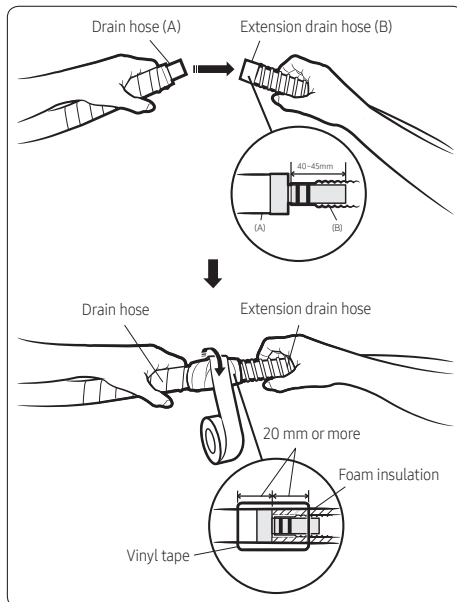

- Do not box in or cover the drain hose connection. It must be accessible for testing later in the installation process and for future servicing.
- If the drain hose is routed inside the room, insulate the hose so that dripping condensation does not damage the furniture or floors.

# Indoor Unit Installation

## Step 2-7 Taping the pipes, cables, and drain hose

- 1 Wrap foam insulation around the refrigerant pipes, up to the connection points. The connections must remain accessible for testing later in the installation process. Either leave slits in the insulation or do not cover the connections.

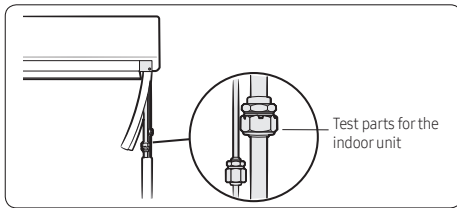
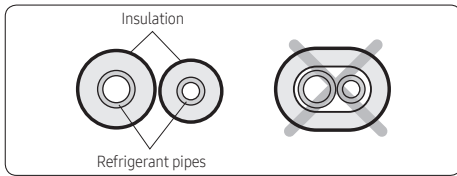

- 2 Make a piping bundle by using vinyl tape to wrap together the refrigerant pipes, power cable, communication cable, and drain hose, up to the connection points. Connection points must remain accessible for testing later in the installation process.

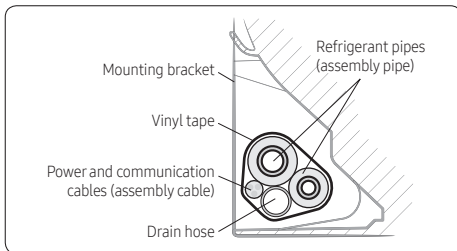

# Outdoor Unit Installation

If using a multi system, install as described in the installation manual supplied with the outdoor unit.

## Step 3-1 Mounting the outdoor unit

To promote proper condensate draining, the recommended installation of the outdoor unit is elevated above the ground on a mounting bracket attached to a concrete pad.

In areas where snowfall occurs, the unit must be mounted above the snow line to allow for proper heating. Snow cannot be allowed to collect on top of the unit. For promoting natural drainage in a heavy snow fall area:

- Make space more 80 mm between the bottom of the outdoor unit and the ground for installation. (Ensure that the drained water runs off correctly and safely.)
- Allow enough separation distance between the product and the ground.

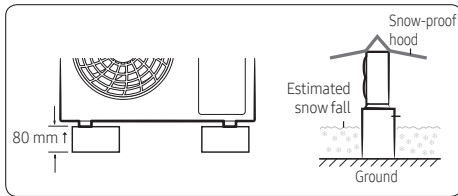

### On the ground

- 1 Place the outdoor unit in the selected installation location (Step 1-1 on page 7), ensuring proper clearances and with the arrow on top of the unit pointing away from the wall.
- 2 Clip the rubber feet to the tabs to minimize sound and vibration to the structure.

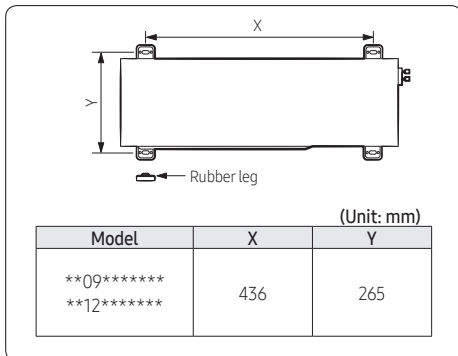

- 3 Level the unit, then use anchor bolts to secure it at the four mounting points.
- 4 For installations in locations that require seismic or hurricane tie downs, comply with local codes.
- 5 If the selected location is exposed to strong winds, install a protective fence around the unit so that the fan can operate correctly.

### On a wall

#### WARNING

- The unit must be properly secured to the wall. If the unit falls, it may result in crushing, electric shock, fire, or explosion that could cause death, severe personal injury, or property damage.

- 1 At the selected installation location (Step 1-1 on page 7), attach the L-bracket to the wall as follows:
  - Install the bracket as close to the wall as possible.
  - Insert rubber isolators between the bracket and the wall to minimize sound and vibration to the structure. Do not fully compress the isolators.

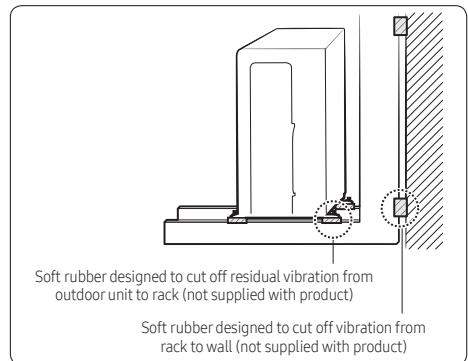

- Make sure that the bracket is level.
  - Use suitable bolts/washers and lock washers.
- 2 Place the outdoor unit on the bracket, ensuring proper clearances and with the arrow on top of the unit pointing away from the wall.
  - 3 Clip the rubber feet to the tabs to minimize sound and vibration to the structure.
  - 4 Level the unit, then use anchor bolts to secure it at the four mounting points.
  - 5 For installations in locations that require seismic or hurricane tie downs, comply with local codes.

# Outdoor Unit Installation

## Step 3-2 Connecting the cables and the pipes

- 1 Route the piping bundle to the outdoor unit.
- 2 Use piping clamps to fasten the piping bundle to the foundation or wall.
- 3 Cut the refrigerant pipes to the length needed to reach the pipe connections (located behind the cover panel; see the figure in step 7).

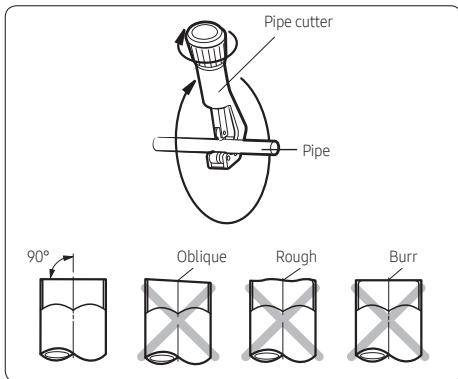

- 4 Remove any burrs, positioning the pipe face down to make sure that the burrs do not get into the pipe.
- 5 Assemble the flare connections on the cut pipe ends.

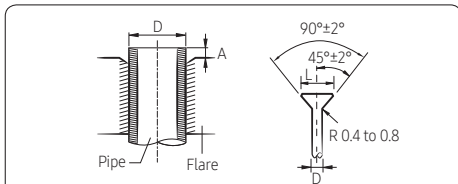

(Unit: mm)

Outer diameter (D)	Depth (A)	Flare dimension (L)
ø 6.35	1.3	8.7-9.1
ø 9.52	1.8	12.8-13.2
ø 12.70	2.0	16.2-16.6
ø 15.88	2.2	19.3-19.7

## ⚠ CAUTION

- Keep the piping length at a minimum to minimize the additional refrigerant charge due to piping extension. **(Maximum allowable piping length: 15 m)**
  - When connecting the pipes, make sure that surrounding objects do not interfere with or contact them to prevent refrigerant leakage due to physical damage.
  - Make sure that the spaces where the refrigerant pipes are installed comply with national gas regulations.
  - Be sure to perform works such as additional refrigerant charging and pipe welding under the conditions of good ventilation.
  - Be sure to perform welding and piping works for mechanical connections under the conditions that the refrigerant does not circulate.
  - When reconnecting the pipes, make sure to perform flared-jointing newly to prevent refrigerant leakage.
  - When working on the refrigerant pipes and the flexible refrigerant connectors, be careful that they are not damaged physically by surrounding objects.
- 6 Remove the cover panel on the unit.

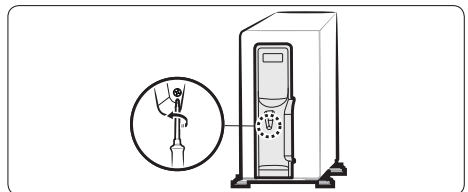

- 7 Remove the service valve caps.

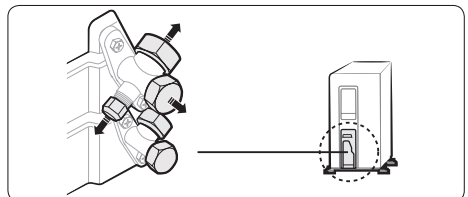

- 
- 8** Connect the pipes to the service valve with the flare nuts. Hand-tighten the nuts to prevent stripping.

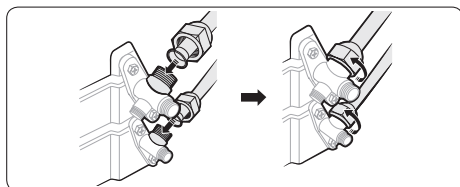

- 9** Torque the flare connections to the values in Step 2-3, step 7 on page 16.
- 10** Connect the power cables and secure with a cable clamp.

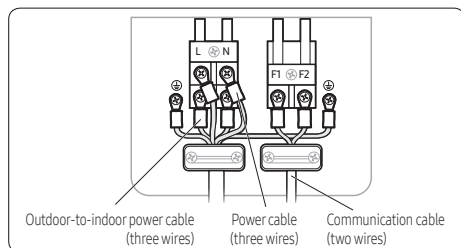

- 11** Connect the outdoor unit power supply cable to the preinstalled disconnect switch.
- 12** Leave the cover panel off for testing later in the installation process.

# Installation Inspection and Testing

## Step 4-1 Performing a drain leak test

- 1 Pour water into the drain pan.

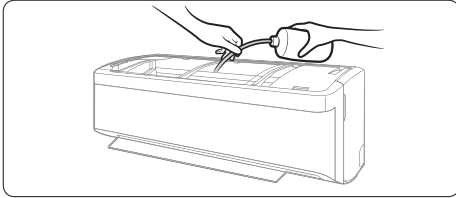

### CAUTION

- Make sure that the water does not overflow onto the electrical connection.
- 2 Check for leaks at the drain connection under the cover panel.

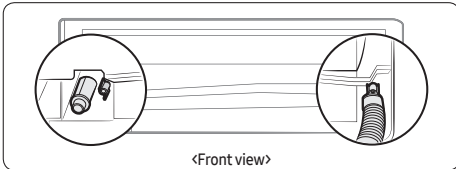

- 3 Make sure that the hose is draining properly at the outdoor unit.

## Step 4-2 Performing the gas leak tests

- 1 Before inspecting the leakage, use a torque wrench to close the cap for the stop valve. (Comply with a tightening torque for each size of the diameter, and tighten the cap firmly to prevent any leakage.)

Tightening torque for body cap (Refer to the table)

Tightening torque for charging port cap (Refer to the table)

Outer diameter (mm)	Tightening torque	
	Body cap (N•m)	Charging port cap (N•m)
ø 6.35	20 to 25	10 to 12
ø 9.52	20 to 25	
ø 12.70	25 to 30	
ø 15.88	30 to 35	
Over ø 19.05	35 to 40	

(1 N•m = 10 kgf•cm)

- 2 Insert inert gas into the pipes connected to indoor and outdoor units.
- 3 Test leakage on the connection parts of the indoor and outdoor units with soap lather or liquid.

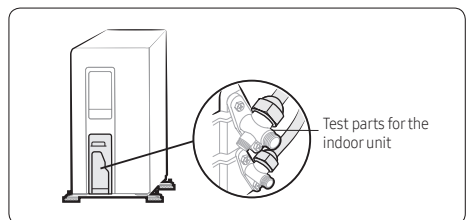
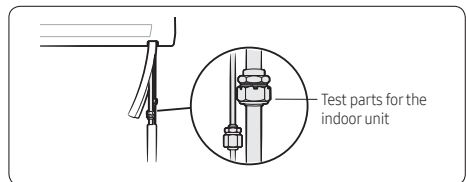



## Step 4-3 Evacuating the system

### CAUTION

- Because the system does not have filter driers, you must perform this triple evacuation procedure to remove all noncondensables and moisture from the system before charging. Failure to do so will result in reduced performance and shorter equipment life.

The time required to perform each evacuation will depend on the capacity (CFM) of the vacuum pump used.

- Install a micron vacuum gauge to the larger liquid/vapor line's service port on the branch of a tee.
- Install the red high-side hose of an R-32 gauge manifold set to the smaller liquid/vapor line's service port on the run of the tee.
- Attach a vacuum pump to the common hose of the manifold set.
- To ensure optimal performance, verify that the vacuum pump's oil has been changed recently.
- With the service port closed and the manifold gauge open, start the vacuum pump and make sure that the vacuum level drops below 4000 microns (as read on the micron gauge). If it is difficult to achieve a proper vacuum, a leak in the hoses is likely. Repair the leak(s) and/or check performance of vacuum pump, then repeat this step.
- Open the service port to connect the system to the manifold.
- Evacuate until 4000 microns is achieved, for at least 10 minutes.
- Close the gauge manifold valve, shut off the vacuum pump, and remove the common hose.
- Connect the hose to the nitrogen pressure regulator and bleed the hose by opening the end of the common hose closest to the manifold.
- Open the high-pressure manifold valve and slowly bring the system pressure to atmosphere (50 kPa).
- Close the manifold and nitrogen cylinder and remove the common hose.
- Reconnect the common hose to the vacuum pump. Repeat steps 6 through 12, alternating between breaking the vacuum with dry nitrogen and evacuating, until system evacuation has occurred three times, to the following vacuum levels:

Evacuation	Microns
First	4000
Second	2000
Third	500

- After evacuating to at least 500 microns for the third time, close the gauge manifold valve and wait 10 minutes, making sure that the vacuum level in the system does not decrease. If it does, a small leak is likely. Repair the leak and repeat the evacuation process.

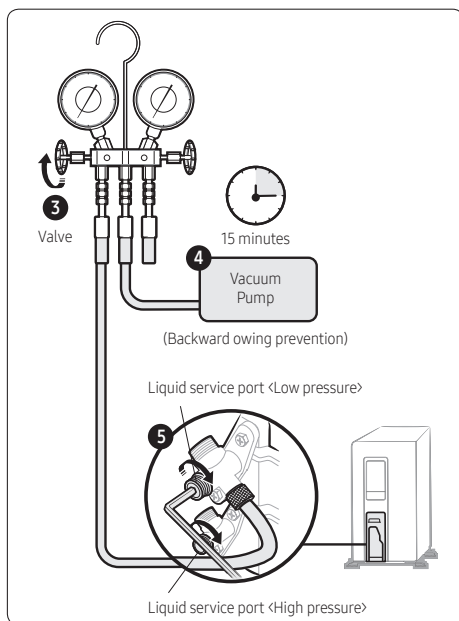

# Installation Inspection and Testing

## Step 4-4 Adding refrigerant (if needed)

The outdoor unit is charged with sufficient R-32 refrigerant to support up to a 5 m line set. For lengths greater than 5 m, you must add 15 g of refrigerant per meter of additional length, after the lines are evacuated.

- 1 Calculate the additional refrigerant required:  
Additional grams of R-32 = (Total line set meter – 5) × 15
- 2 Connect the common hose of the manifold gauge set to the inverted R-32 refrigerant cylinder.
- 3 Place the refrigerant cylinder on a scale set to measure grams.
- 4 Open the valve on the tank.
- 5 At the manifold connection, bleed the refrigerant to remove any air that may be present in the common hose.
- 6 Open the gauge manifold and charge the system with the amount of refrigerant calculated in step 1.
- 7 Close the gauge manifold valve, close the valve on the refrigerant tank, and remove the common hose.

### Precautions on adding the R-32 refrigerant

In addition to the conventional charging procedure, the following requirements shall be kept.

- Make sure that contamination by other refrigerants does not occur for charging.
- To minimize the amount of refrigerant, keep the hoses and lines as short as possible.
- The cylinders shall be kept upright.
- Make sure that the refrigeration system is earthed before charging.
- Label the system after charging, if necessary.
- Extreme care is required not to overcharge the system.
- Before recharging, the pressure shall be checked with nitrogen blowing.
- After charging, check for leakage before commissioning.
- Be sure to check for leakage before leaving the work area.

## Step 4-5 Important information: regulation regarding the refrigerant used

This product contains fluorinated greenhouse gases. Do not vent gases into the atmosphere.

### CAUTION

- Inform user if the system contains 5 tCO<sub>2</sub>e or more of fluorinated greenhouse gases. In this case, it must be checked for leakage at least once every 12 months, according to regulation No. 517/2014. This activity must be covered by qualified personnel only. In the case of the situation above, the installer (or authorized person with responsibility for final check) must provide a maintenance book, with all the information recorded, according to REGULATION (EU) No. 517/2014 OF THE EUROPEAN PARLIAMENT AND OF THE COUNCIL of 16 April 2014 on fluorinated greenhouse gases.

- 1 Please fill in the following with indelible ink on the refrigerant charge label supplied with this product and on this manual.

- ① the factory refrigerant charge of the product,
- ② the additional refrigerant amount charged in the field and
- ①+② the total refrigerant charge. on the refrigerant charge label supplied with the product.

Refrigerant type	GWPvalue
R-32	675
<ul style="list-style-type: none"> <li>• GWP: Global Warming Potential</li> <li>• Calculating tCO<sub>2</sub>e: kg x GWP/1000</li> </ul>	

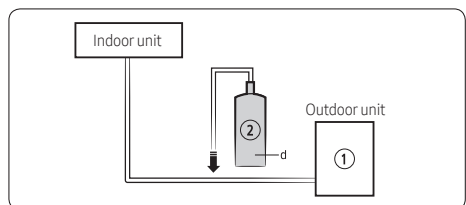

Unit	Kg	tCO <sub>2</sub> e
①, a		
②, b		
①+②, c		

## NOTE

- Factory refrigerant charge of the product: see unit name plate
- Additional refrigerant amount charged in the field (Refer to the above information for the quantity of refrigerant replenishment.)
- Total refrigerant charge
- Refrigerant cylinder and manifold for charging

## CAUTION

- The filled-out label must be adhered in the proximity of the product charging port (e.g. onto the inside of the stop valve cover).
- Make sure that the total refrigerant charge does not exceed (A), the maximum refrigerant charge, which is calculated in the following formula: Maximum refrigerant charge (A) = factory refrigerant charge (B) + maximum additional refrigerant charge due to piping extension (C)
- Here below, the summary table with refrigerant charge limits for each products.

(Unit:g)



Model	A	B	C
	850	700	150



## Step 4-6 Preparing the system for commissioning

- Wrap the remaining refrigerant pipe lengths and connection points with foam insulation.
- Wrap the unwrapped portions of the piping bundle with vinyl tape.
- With the manifold gauge set still installed, open the isolation valves on the outdoor unit to connect the outdoor unit to the line set and indoor unit.
- Remove the manifold set and vacuum gage.

## Step 4-7 Commissioning the unit











The unit is commissioned using the Smart Install feature. Smart Install can be started only with the remote control. While Smart Install is running, you cannot operate the remote control.

- Make sure that the air conditioner is in standby status (powered up with the controller in off mode).
- Install batteries in the remote control.
- Hold down the  (Power),  (Mode), and  (SET) buttons on the remote control simultaneously for 4 seconds.
- Wait until Smart Install succeeds or fails (approximately 7 to 13 minutes).
  - While Smart Install is running:

Type	 Display
Indoor unit indicator	
	The progress is displayed as a number between 0 and 99 on the indoor unit display.

- When Smart Install succeeds: Smart Install ends with a ringing sound, and the air conditioner returns to standby status.
- When Smart Install fails: An error message is displayed on the indoor unit display, and Smart Install ends. To correct the problem, see the error table on page 28.

# Installation Inspection and Testing

Error indicator	Error	Measures for the installer to take
 Display		
	Communication error between indoor and outdoor units	<ul style="list-style-type: none"> <li>Check the cables between the indoor and outdoor units. See if the power cable or communication cable is crossed.</li> </ul>
	Error on indoor temperature sensor	<ul style="list-style-type: none"> <li>Make sure that the indoor temperature sensor is properly connected.</li> </ul>
 	Error on indoor heat exchanger	<ul style="list-style-type: none"> <li>Make sure that the evaporator temperature sensor is properly connected.</li> </ul>
	Error on indoor fan motor	<ul style="list-style-type: none"> <li>Make sure that the evaporator motor is properly connected to the board.</li> <li>Check for a foreign substance inside the unit that may be preventing the blower wheel from turning.</li> </ul>
  	EEPROM/Option error	<ul style="list-style-type: none"> <li>Reset the option codes.</li> </ul>
	Refrigerant flow blocking error	<ul style="list-style-type: none"> <li>Make sure that the service valves are completely open.</li> <li>Check for any blockage in the refrigerant pipe that connects the indoor and outdoor units.</li> <li>Check for refrigerant leaks.</li> </ul>
	Lack of refrigerant (for inverter models only)	<ul style="list-style-type: none"> <li>Make sure a sufficient amount of refrigerant has been added for a pipe that is longer than 7.5 m.</li> <li>Check for refrigerant leaks between the valve and pipe connection.</li> </ul>



## Step 4-8 Performing final checks and trial operation

### WARNING

Stop the unit, disconnect the power, and contact Samsung technical support if any of the following occurs:

- The unit produces a burning smell or smoke.
- The power cable is hot or damaged.
- The unit is very noisy.
- Any foreign substance, such as water, has entered the appliance.
- The appliance becomes flooded.

- Check the following:
  - Strength of the installation site
  - Tightness of pipe connection to detect gas leak
  - Electric wiring connection
  - Heat-resistant insulation of the pipe
  - Drainage
  - Grounding conductor connection
  - Correct operation (Take the following steps.)
- Press the  (Power) button on the remote control to check the following:
  - The indicator on the indoor unit lights up.
  - The airflow blade opens and the fan gears up for operation.

- 3 Press the  (Mode) button to select Cool or Heat mode. Then take the following sub-steps:
  - In Cool mode, use the Temperature button to set the set temperature to 16 °C.
  - In Heat mode, use the Temperature button to set the set temperature to 30 °C.
  - Check whether, approximately 3 to 5 minutes later, the outdoor unit starts, and a cool air blows out.
  - After 12 minutes of stationary condition, check the indoor unit air treatment.
- 4 Press the  (Air swing) button to check whether the airflow blades work properly.
- 5 Press the  (Power) button to stop the trial operation.

### CAUTION

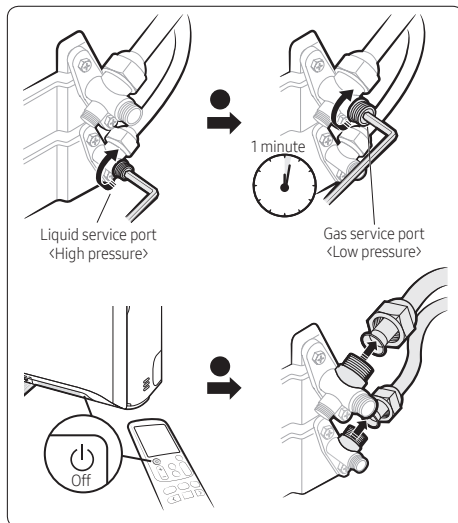

- Compressor damage may occur if the compressor is run at a negative suction pressure.



### Pumping down for removing the product

Pump-down is an operation intended to collect all the system refrigerant in the outdoor unit. This operation must be carried out before disconnecting the refrigerant tubing in order to avoid refrigerant loss to the atmosphere.

### WARNING

- After installing the product, be sure to perform leak tests on the piping connections. After pumping down refrigerant to inspect or relocate the outdoor unit, be sure to stop the compressor and then remove the connected pipes.
    - Do not operate the compressor while a valve is open due to refrigerant leakage from a pipe or an unconnected or incorrectly connected pipe. Failure to do so may cause air to flow into the compressor and too a high pressure to develop inside the refrigerant circuit, leading to an explosion or product malfunction.
- 1 Hold down the  (Power) button on the indoor unit for 5 seconds. Beep sounds immediately to indicate that the product is ready for pump down procedure.
  - 2 Let the compressor run for more than 5 minutes.
  - 3 Release the valve caps on High and Low pressure side.
  - 4 Use L-wrench to close the valve on the high pressure side.
  - 5 After approximately 1 minute, close the valve on the low pressure side.
  - 6 Stop operation of the air conditioner by pressing the  (Power) button on the indoor unit or remote control.
  - 7 Disconnect the pipes.

# Maintenance Procedures

---

## Performing the gas leak tests for repair

---

In case of repair of the refrigerant circuit, the following procedure must be kept to consider flammability.

- 1 Remove the refrigerant.
- 2 Purge the refrigerant circuit with inert gas.
- 3 Perform evacuation.
- 4 Purge the circuit again with inert gas.
- 5 Open the circuit.
- 6 Perform repair work.
- 7 Charge the system with refrigerant.
- 8 Flush the system with nitrogen blowing for safety.
- 9 Repeat the previous steps several times until no refrigerant is within the system.



### CAUTION

- Compressed air or oxygen shall not be used.
- Flush the system with nitrogen blowing, fill the refrigerant until the working pressure is reached, ventilate to atmosphere, and then pull down to a vacuum state.
- For the final nitrogen blowing charge, the system shall be ventilated down to atmospheric pressure.
- The procedure is absolutely vital in case of brazing on the pipings.
- Make sure that the outlet of the vacuum pump is not closed to any ignition sources and there is ventilation available.
- Do not apply any permanent inductive or capacitance loads to the circuit without ensuring that this will not exceed the permissible voltage and current permitted for the air conditioner.

## Decommissioning

---

The following requirements must be fulfilled before and while taking the decommissioning procedure:

- Before decommissioning, the worker shall be familiar with the product details.
  - The entire refrigerant shall be recovered safely.
  - Before starting the process, oil and refrigerant samples shall be taken just in case analysis is required for reuse.
  - Before starting the process, power supply must be available.
- 1 Be familiar with the equipment details.

- 2 Isolate the system electrically.
- 3 Before starting the process, make sure that:
  - Any mechanical equipment is available for handling refrigerant cylinders.
  - All PPE (personal protective equipment) is available for servicing.
  - The recovery process shall be supervised by a competent person.
  - The recovery equipment and cylinders comply with the standards.
- 4 Lower the refrigeration system, if possible.
- 5 If vacuuming is not possible, make a manifold so that refrigerant can be easily removed from the parts of the system.
- 6 Make sure that the cylinders are placed on the scales before recovery.
- 7 Run the recovery system in accordance with the manufacturer's instructions.
- 8 Do not overcharge the cylinders. (No more than 80 %)
- 9 Be sure to keep the cylinder within the maximum working pressure, even temporarily.
- 10 After charging, make sure that the cylinders and the equipment are promptly removed from the site and all isolation valves are closed.
- 11 Recovered refrigerant shall not be charged into other refrigeration system unless it is cleaned and checked.

# Sub PCB installation(optional)

(Wired remote controller, central remote controller etc.)

- 1 Turn the power off and take off the cover panel of the indoor unit.

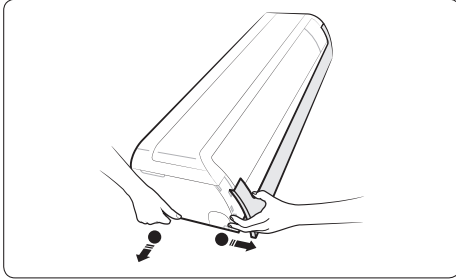

- 2 Attach the Sub PCB to the Case Sub PCB.
- 3 Assemble the Case Sub PCB to the indoor unit.

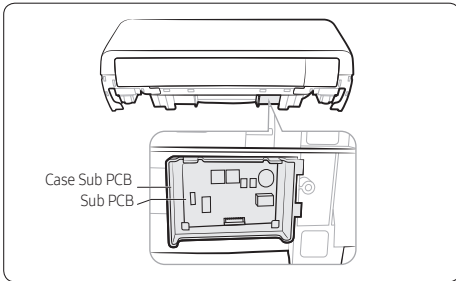

- 4 Find the PCB wire, and connect the wire to the Sub PCB as seen in the picture.

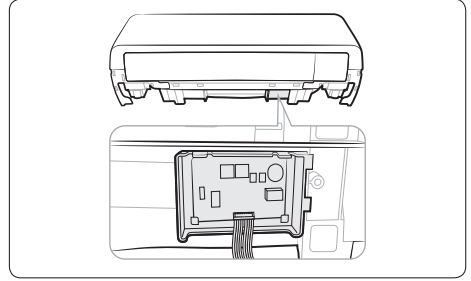

- 5 Connect the wire(remote controller, central remote controller etc) to the Sub PCB.
- 6 Assemble the Cover PCB and the front panel.  
※If the Sub PCB is not installed, arrange the wire for multi system (connection) as shown in the illustration.

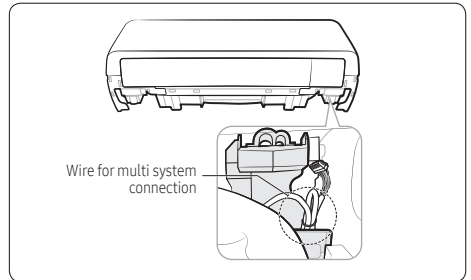

## NOTE

- The Sub PCB is attached to be controlled by the wired remote controller and central controller.

**SAMSUNG**