

# TOSHIBA

## AIR CONDITIONER (MULTI TYPE) Installation Manual

R410A

For commercial use

### Indoor Unit

Model name:

---

<Compact 4-way Cassette type>

**MMU-UP0051MH-E**

**MMU-UP0071MH-E**

**MMU-UP0091MH-E**

**MMU-UP0121MH-E**

**MMU-UP0151MH-E**

**MMU-UP0181MH-E**

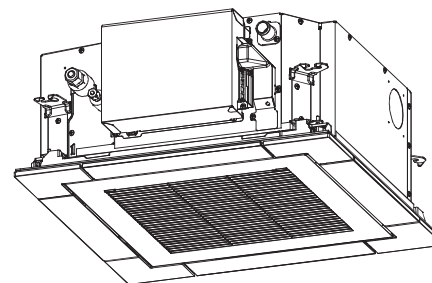

**Original instruction**

Please read this Installation Manual carefully before installing the Air Conditioner.

- This Manual describes the installation method of the indoor unit.
- For installation of the outdoor unit, follow the Installation Manual attached to the outdoor unit.

**ADOPTION OF R410A REFRIGERANT**

This Air Conditioner uses R410A an environmentally friendly refrigerant.

**Information**

If U series models (TU2C-Link) are combined with models other than U series (TCC-Link), the wiring specifications and maximum number of connectable indoor units will be changed. Pay attentions to their communication specifications when carrying out the installation, maintenance, or repair. For its details, refer to the “**Electrical connection**” in this Manual.

**Contents**

<b>1</b>	<b>Precautions for safety</b>	<b>3</b>
<b>2</b>	<b>Accessory parts</b>	<b>7</b>
<b>3</b>	<b>Selection of installation place</b>	<b>7</b>
<b>4</b>	<b>Installation</b>	<b>9</b>
<b>5</b>	<b>Drain piping</b>	<b>11</b>
<b>6</b>	<b>Refrigerant piping</b>	<b>13</b>
<b>7</b>	<b>Electrical connection</b>	<b>14</b>
<b>8</b>	<b>Applicable controls</b>	<b>18</b>
<b>9</b>	<b>Test run</b>	<b>20</b>
<b>10</b>	<b>Maintenance</b>	<b>21</b>
<b>11</b>	<b>Troubleshooting</b>	<b>22</b>
<b>12</b>	<b>Specifications</b>	<b>27</b>

Thank you for purchasing this Toshiba air conditioner.

Please read carefully through these instructions that contain important information which complies with the "Machinery" Directive (Directive 2006/42/EC), and ensure that you understand them.

After completing the installation work, hand over this Installation Manual as well as the Owner's Manual provided with the outdoor unit to the user, and ask the user to keep them in a safe place for future reference.

#### Generic denomination: Air conditioner

#### Definition of qualified installer or qualified service person

The air conditioner must be installed, maintained, repaired and removed by a qualified installer or qualified service person. When any of these jobs is to be done, ask a qualified installer or qualified service person to do them.

A qualified installer or qualified service person is an agent who has the qualifications and knowledge described in the table below.

Agent	Qualifications and knowledge which the agent must have
Qualified installer (*1)	<ul style="list-style-type: none"> <li>The qualified installer is a person who installs, maintains, relocates and removes the air conditioners made by Toshiba Carrier Corporation. He or she has been trained to install, maintain, relocate and remove the air conditioners made by Toshiba Carrier Corporation or, alternatively, he or she has been instructed in such operations by an individual or individuals who have been trained and is thus thoroughly acquainted with the knowledge related to these operations.</li> <li>The qualified installer who is allowed to do the electrical work involved in installation, relocation and removal has the qualifications pertaining to this electrical work as stipulated by the local laws and regulations, and he or she is a person who has been trained in matters relating to electrical work on the air conditioners made by Toshiba Carrier Corporation or, alternatively, he or she has been instructed in such matters by an individual or individuals who have been trained and is thus thoroughly acquainted with the knowledge related to this work.</li> <li>The qualified installer who is allowed to do the refrigerant handling and piping work involved in installation, relocation and removal has the qualifications pertaining to this refrigerant handling and piping work as stipulated by the local laws and regulations, and he or she is a person who has been trained in matters relating to refrigerant handling and piping work on the air conditioners made by Toshiba Carrier Corporation or, alternatively, he or she has been instructed in such matters by an individual or individuals who have been trained and is thus thoroughly acquainted with the knowledge related to this work.</li> <li>The qualified installer who is allowed to work at heights has been trained in matters relating to working at heights with the air conditioners made by Toshiba Carrier Corporation or, alternatively, he or she has been instructed in such matters by an individual or individuals who have been trained and is thus thoroughly acquainted with the knowledge related to this work.</li> </ul>
Qualified service person (*1)	<ul style="list-style-type: none"> <li>The qualified service person is a person who installs, repairs, maintains, relocates and removes the air conditioners made by Toshiba Carrier Corporation. He or she has been trained to install, repair, maintain, relocate and remove the air conditioners made by Toshiba Carrier Corporation or, alternatively, he or she has been instructed in such operations by an individual or individuals who have been trained and is thus thoroughly acquainted with the knowledge related to these operations.</li> <li>The qualified service person who is allowed to do the electrical work involved in installation, repair, relocation and removal has the qualifications pertaining to this electrical work as stipulated by the local laws and regulations, and he or she is a person who has been trained in matters relating to electrical work on the air conditioners made by Toshiba Carrier Corporation or, alternatively, he or she has been instructed in such matters by an individual or individuals who have been trained and is thus thoroughly acquainted with the knowledge related to this work.</li> <li>The qualified service person who is allowed to do the refrigerant handling and piping work involved in installation, repair, relocation and removal has the qualifications pertaining to this refrigerant handling and piping work as stipulated by the local laws and regulations, and he or she is a person who has been trained in matters relating to refrigerant handling and piping work on the air conditioners made by Toshiba Carrier Corporation or, alternatively, he or she has been instructed in such matters by an individual or individuals who have been trained and is thus thoroughly acquainted with the knowledge related to this work.</li> <li>The qualified service person who is allowed to work at heights has been trained in matters relating to working at heights with the air conditioners made by Toshiba Carrier Corporation or, alternatively, he or she has been instructed in such matters by an individual or individuals who have been trained and is thus thoroughly acquainted with the knowledge related to this work.</li> </ul>

#### Definition of protective gear



When the air conditioner is to be transported, installed, maintained, repaired or removed, wear protective gloves and 'safety' work clothing.

In addition to such normal protective gear, wear the protective gear described below when undertaking the special work detailed in the table below.

Failure to wear the proper protective gear is dangerous because you will be more susceptible to injury, burns, electric shocks and other injuries.

Work undertaken	Protective gear worn
All types of work	Protective gloves 'Safety' working clothing
Electrical-related work	Gloves to provide protection for electricians Insulating shoes Clothing to provide protection from electric shock
Work done at heights (50 cm or more)	Helmets for use in industry
Transportation of heavy objects	Shoes with additional protective toecap
Repair of outdoor unit	Gloves to provide protection for electricians

These safety cautions describe important matters concerning safety to prevent injury to users or other people and damages to property. Please read through this manual after understanding the contents below (meanings of indications), and be sure to follow the description.





Indication	Meaning of Indication
 <b>WARNING</b>	Text set off in this manner indicates that failure to adhere to the directions in the warning could result in serious bodily harm (*1) or loss of life if the product is handled improperly.
 <b>CAUTION</b>	Text set off in this manner indicates that failure to adhere to the directions in the caution could result in slight injury (*2) or damage (*3) to property if the product is handled improperly.

\*1: Serious bodily harm indicates loss of eyesight, injury, burns, electric shock, bone fracture, poisoning, and other injuries which leave aftereffect and require hospitalization or long-term treatment as an outpatient.

\*2: Slight injury indicates injury, burns, electric shock, and other injuries which do not require hospitalization or long-term treatment as an outpatient.

\*3: Damage to property indicates damage extending to buildings, household effects, domestic livestock, and pets.

■ **Warning indications on the air conditioner unit**

Warning indication		Description
 <p><b>WARNING</b> <b>ELECTRICAL SHOCK HAZARD</b> Disconnect all remote electric power supplies before servicing.</p>	<p><b>WARNING</b> <b>ELECTRICAL SHOCK HAZARD</b> Disconnect all remote electric power supplies before servicing.</p>	
 <p><b>WARNING</b> Moving parts. Do not operate unit with grille removed. Stop the unit before the servicing.</p>	<p><b>WARNING</b> Moving parts. Do not operate unit with grille removed. Stop the unit before the servicing.</p>	
 <p><b>CAUTION</b> High temperature parts. You might get burned when removing this panel.</p>	<p><b>CAUTION</b> High temperature parts. You might get burned when removing this panel.</p>	
 <p><b>CAUTION</b> Do not touch the aluminum fins of the unit. Doing so may result in injury.</p>	<p><b>CAUTION</b> Do not touch the aluminium fins of the unit. Doing so may result in injury.</p>	
 <p><b>CAUTION</b> <b>BURST HAZARD</b> Open the service valves before the operation, otherwise there might be the burst.</p>	<p><b>CAUTION</b> <b>BURST HAZARD</b> Open the service valves before the operation, otherwise there might be the burst.</p>	

# 1 Precautions for safety

The manufacturer shall not assume any liability for the damage caused by not observing the description of this manual.

## **WARNING**

### General

- Before starting to install the air conditioner, read through the Installation Manual carefully, and follow its instructions to install the air conditioner.
- Only a qualified installer or service person is allowed to do installation work. Inappropriate installation may result in water leakage, electric shock or fire.
- Do not use any refrigerant different from the one specified for complement or replacement. Otherwise, abnormally high pressure may be generated in the refrigeration cycle, which may result in a failure or explosion of the product or an injury to your body.
- Before opening the intake grille of the indoor unit or service panel of the outdoor unit, set the circuit breaker to the OFF position. Failure to set the circuit breaker to the OFF position may result in electric shocks through contact with the interior parts. Only a qualified installer (\*1) or qualified service person (\*1) is allowed to remove the intake grille of the indoor unit or service panel of the outdoor unit and do the work required.
- Before carrying out the installation, maintenance, repair or removal work, set the circuit breaker to the OFF position. Otherwise, electric shocks may result.
- Place a “Work in progress” sign near the circuit breaker while the installation, maintenance, repair or removal work is being carried out. There is a danger of electric shocks if the circuit breaker is set to ON by mistake.
- Only a qualified installer (\*1) or qualified service person (\*1) is allowed to undertake work at heights using a stand of 50 cm or more or to remove the intake grille of the indoor unit to undertake work.
- Wear protective gloves and safety work clothing during installation, servicing and removal.
- Do not touch the aluminum fin of the unit. You may injure yourself if you do so. If the fin must be touched for some reason, first put on protective gloves and safety work clothing, and then proceed.
- Do not climb onto or place objects on top of the outdoor unit. You may fall or the objects may fall off of the outdoor unit and result in injury.

- When work is performed at heights, use a ladder which complies with the ISO 14122 standard, and follow the procedure in the ladder's instructions. Also wear a helmet for use in industry as protective gear to undertake the work.
- Before cleaning the filter or other parts of the indoor unit, set the circuit breaker to OFF without fail, and place a "Work in progress" sign near the circuit breaker before proceeding with the work.
- Before working at heights, put a sign in place so that no-one will approach the work location, before proceeding with the work. Parts and other objects may fall from above, possibly injuring a person below. While carrying out the work, wear a helmet for protection from falling objects.
- The refrigerant used by this air conditioner is the R410A.
- The air conditioner must be transported in stable condition. If any part of the product is broken, contact the dealer.
- When the air conditioner must be transported by hand, carry it by two or more people.
- Do not move or repair any unit by yourself. There is high voltage inside the unit. You may get electric shock when removing the cover and main unit.
- This appliance is intended to be used by expert or trained users in shops, in light industry, or for commercial use by lay persons.

### **Selection of installation location**

- When the air conditioner is installed in a small room, provide appropriate measures to ensure that the concentration of refrigerant leakage occur in the room does not exceed the critical level.
- Do not install in a location where flammable gas leaks are possible. If the gas leak and accumulate around the unit, it may ignite and cause a fire.
- To transport the air conditioner, wear shoes with additional protective toe caps.
- To transport the air conditioner, do not take hold of the bands around the packing carton. You may injure yourself if the bands should break.
- Install the indoor unit at least 2.5 m above the floor level since otherwise the users may injure themselves or receive electric shocks if they poke their fingers or other objects into the indoor unit while the air conditioner is running.
- Do not place any combustion appliance in a place where it is directly exposed to the wind of air conditioner, otherwise it may cause imperfect combustion.

### **Installation**

- When the indoor unit is to be suspended, the designated hanging bolts (M10 or W3/8) and nuts (M10 or W3/8) must be used.
- Install the air conditioner securely in a location where the base can sustain the weight adequately. If the strength is not enough, the unit may fall down resulting in injury.
- Follow the instructions in the Installation Manual to install the air conditioner. Failure to follow these instructions may cause the product to fall down or topple over or give rise to noise, vibration, water leakage or other trouble.
- Carry out the specified installation work to guard against the possibility of earthquake. If the air conditioner is not installed appropriately, a unit may topple over or fall down, causing an accident.
- If refrigerant gas has leaked during the installation work, ventilate the room immediately. If the leaked refrigerant gas comes in contact with fire, noxious gas may generate.
- Use forklift to carry in the air conditioner units and use winch or hoist at installation of them.

### **Refrigerant piping**

- Install the refrigerant pipe securely during the installation work before operating the air conditioner. If the compressor is operated with the valve open and without refrigerant pipe, the compressor sucks air and the refrigeration cycles is over pressurized, which may cause a injury.
- Tighten the flare nut with a torque wrench in the specified manner. Excessive tighten of the flare nut may cause a crack in the flare nut after a long period, which may result in refrigerant leakage.
- After the installation work, confirm that refrigerant gas does not leak. If refrigerant gas leaks into the room and flows near a fire source, such as a cooking range, noxious gas may be generated.
- When the air conditioner has been installed or relocated, follow the instructions in the Installation Manual and purge the air completely so that no gases other than the refrigerant will be mixed in the refrigerating cycle. Failure to purge the air completely may cause the air conditioner to malfunction.
- Nitrogen gas must be used for the airtight test.
- The charge hose must be connected in such a way that it is not slack.
- If refrigerant gas has leaked during the installation work, ventilate the room immediately. If the leaked refrigerant gas comes in contact with fire, noxious gas may be generated.

## Electrical wiring

- Only a qualified installer (\*1) or qualified service person (\*1) is allowed to carry out the electrical work of the air conditioner. Under no circumstances must this work be done by an unqualified individual since failure to carry out the work properly may result in electric shocks and/or electrical leaks.
- To connect the electrical wires, repair the electrical parts or undertake other electrical jobs, wear gloves to provide protection for electricians and from heat, insulating shoes and clothing to provide protection from electric shocks. Failure to wear this protective gear may result in electric shocks.
- Use wiring that meets the specifications in the Installation Manual and the stipulations in the local regulations and laws. Use of wiring which does not meet the specifications may give rise to electric shocks, electrical leakage, smoking and/or a fire.
- Be sure to connect earth wire. (Grounding work)  
Incomplete grounding causes an electric shock.
- Do not connect earth wires to gas pipes, water pipes, and lightning conductor or telephone earth wires.
- After completing the repair or relocation work, check that the earth wires are connected properly.
- Install a circuit breaker that meets the specifications in the installation manual and the stipulations in the local regulations and laws.
- Install the circuit breaker where it can be easily accessed by the agent.
- When installing the circuit breaker outdoors, install one which is designed to be used outdoors.
- Under no circumstances the power wire must not be extended.  
Connection trouble in the places where the wire is extended may give rise to smoking and/or a fire.
- Electrical wiring work shall be conducted according to law and regulation in the community and installation manual.  
Failure to do so may result in electrocution or short circuit.

## Test run

- Before operating the air conditioner after having completed the work, check that the electrical control box cover of the indoor unit and service panel of the outdoor unit are closed, and set the circuit breaker to the ON position. You may receive an electric shock if the power is turned on without first conducting these checks.

- If there is any kind of trouble (such as check code display has appeared, smell of burning, abnormal sounds, the air conditioner fails to cool or heat or water is leaking) has occurred in the air conditioner, do not touch the air conditioner yourself but set the circuit breaker to the OFF position, and contact a qualified service person. Take steps to ensure that the power will not be turned on (by marking "out of service" near the circuit breaker, for instance) until qualified service person arrives. Continuing to use the air conditioner in the trouble status may cause mechanical problems to escalate or result in electric shocks or other trouble.
- After the work has finished, use an insulation tester set (500 VMΩ) to check the resistance is 1 MΩ or more between the charge section and the non-charge metal section (Earth section). If the resistance value is low, a disaster such as a leak or electric shock is caused at user's side.
- Upon completion of the installation work, check for refrigerant leaks and check the insulation resistance and water drainage. Then conduct a test run to check that the air conditioner is operating properly.

## Explanations given to user

- Upon completion of the installation work, tell the user where the circuit breaker is located. If the user does not know where the circuit breaker is, he or she will not be able to turn it off in the event that trouble has occurred in the air conditioner.
- After the installation work, follow the Owner's Manual to explain to the customer how to use and maintain the unit.

## Relocation

- Only a qualified installer (\*1) or qualified service person (\*1) is allowed to relocate the air conditioner. It is dangerous for the air conditioner to be relocated by an unqualified individual since a fire, electric shocks, injury, water leakage, noise and/or vibration may result.
- When carrying out the pump-down work shut down the compressor before disconnecting the refrigerant pipe. Disconnecting the refrigerant pipe with the service valve left open and the compressor still operating will cause air or other gas to be sucked in, raising the pressure inside the refrigeration cycle to an abnormally high level, and possibly resulting in rupture, injury or other trouble.

---

(\*1) Refer to the "Definition of qualified installer or qualified service person".

---

**⚠ CAUTION**

---







**R410A refrigerant air conditioner installation**

- **This air conditioner adopts the HFC refrigerant (R410A) which does not destroy ozone layer.**
- The characteristics of R410A refrigerant are; easy to absorb water, oxidizing membrane or oil, and its pressure is approx. 1.6 times higher than that of refrigerant R22. Accompanied with the R410A refrigerant, refrigerating oil has also been changed. Therefore, do not let water, dust, former refrigerant, or refrigerating oil enter the refrigerating cycle during installation work.
- To prevent charging an incorrect refrigerant and refrigerating oil, the sizes of connecting sections of charging port of the main unit and installation tools are changed from those for the conventional refrigerant.
- Accordingly the exclusive tools are required for the R410A refrigerant.
- For connecting pipes, use new and clean piping designed for R410A, and please care so that water or dust does not enter.

**To Disconnect the Appliance from Main Power Supply.**

- This appliance must be connected to the main power supply by means of a switch with a contact separation of at least 3 mm.
-

## 2 Accessory parts

Part name	Qty	Shape	Usage
Installation Manual	1	This manual	Hand over to customers (For other languages that do not appear in this Installation Manual, please refer to the enclosed CD-R.)
CD-ROM	1	—	Installation Manual
Heat insulation pipe	2		For heat insulation of the pipe connecting section
Installation pattern	1	—	For checking of ceiling opening and the main unit position
Installation gauge	2		For positioning of the ceiling position (To be used with the installation pattern)
Heat insulator	1		For heat insulation of drain connecting section
Eccentric washer	4		For hanging-up of unit
Washer	4		For hanging-up of unit
Hose band	2		For connecting drain pipe
Flexible hose	1		For adjusting core-out of drain pipe

### ■ Separate sold parts

The Ceiling panel and remote controller are sold separately. For the installation of these products, follow the Installation Manuals supplied with them.

## 3 Selection of installation place

### WARNING

- **Install the air conditioner securely in a location where the base can sustain the weight adequately.**  
If the strength is not enough, the unit may fall down resulting in injury.
- **Install the air conditioner at a height 2.5 m or more from the floor.**  
If you insert your hands or others directly into the unit while the air conditioner operates, it is dangerous because you may contact with revolving fan or active electricity.

### CAUTION

- **Do not install in a location where flammable gas may leaks are possible.**  
If the gas leak and accumulate around the unit, it may ignite and cause a fire.

**Upon approval of the customer, install the air conditioner in a place that satisfies the following conditions.**

- Place where the unit can be installed horizontally.
- Place where a sufficient servicing space can be ensured for safety maintenance and check.
- Place where drained water will not cause any problem.

**Avoid installing in the following places.**

- Place exposed to air with high salt content (seaside area), or place exposed to large quantities of sulfide gas (hot spring).  
(The unit should be used in these places, special protective measures are needed.)
- A kitchen in restaurant or places around machines and equipment in a factory, where a lot of oils are used.  
(Oil adhering to the heat exchanger and the resin parts in the indoor unit may lower the unit performance, splash water drops, or produce mist and may cause the resin parts to be deformed or damaged.)
- Places where iron or other metal dust is present. If iron or other metal dust adheres to or collects on the interior of the air conditioner, it may spontaneously combust and start a fire.
- Place where organic solvent is used nearby.
- Place close to a machine generating high frequency.
- Place where the discharged air blows directly into the window of the neighbour house. (Outdoor unit)
- Place where noise of the outdoor unit is easily transmitted.  
(When the outdoor unit is installed on the boundary with the neighbour, pay due attention to the level of noise.)
- Place with poor ventilation. (Before air duct work, check whether value of fan speed, static pressure and duct resistance are correct.)
- Do not use the air conditioner for special purposes such as preserving food, precision instruments, or art objects, or where breeding animals or growing plants are kept. (This may degrade the quality of preserved materials.)
- Place where any of high-frequency appliances (including inverter devices, private power generators, medical equipment, and communication equipment) and inverter-type fluorescent light is installed.  
(A malfunction of the air conditioner, abnormal control, or problems due to noise to such appliances / equipment may occur.)
- When the wireless remote controller is used in a room equipped with an inverter-type fluorescent light or at a place exposed to direct sunlight, signals from the remote controller may not be received correctly.
- Place where organic solvent is used.
- Place near a door or window exposed to humid outside air (Dew drop may form.).
- Place where special spray is used frequently.



## ■ Installation space

Ensure there is sufficient space to install the unit and to perform maintenance work as and when required. Keep 15 mm or more for clearance between top plate of the indoor unit and the ceiling surface.

Unit: mm

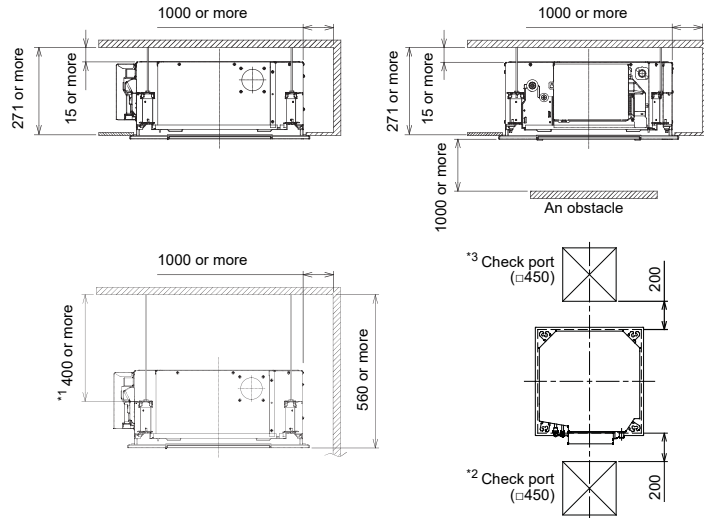

### REQUIREMENT

- \*1 If there is no ceiling board, the length of the hanging bolt shall be more than 400 mm.
- \*2 Set a service check opening panel at electrical control box side of the unit (size: 450 × 450 mm or more) for piping, maintenance, and servicing.
- \*3 For the adjustment of the installation height of the indoor unit.

## ■ Selection of installation place

Continual operation of the indoor unit under high-humidity conditions as described below, dew may condense and water may drop.

Especially, high-humidity atmosphere (dew point temperature: 23°C or more) may generate dew inside the ceiling.

1. Unit is installed inside the ceiling with slated roof.
2. Unit is installed at a location using inside of the ceiling as fresh air intake path.
3. Kitchen

### REQUIREMENT

When the humidity inside the ceiling seems to be higher than 80%, attach a heat insulator to the side (top) surface of the indoor unit. (Use a heat insulator that is 10 mm or more thick.)

## ■ Ceiling height

Unit: m

Model MMU-	Installable ceiling height
UP005 to UP012 type	Up to 2.7
UP015 to UP018 type	Up to 3.5

When the height of the ceiling exceeds the distance of the item Standard / 4-way in below table, the warm air is difficult to reach the floor.

It is necessary to change the setup value of the high ceiling setting or discharge direction.

### ▼ Height list of ceiling possible to be installed

Unit: m

Indoor unit Capacity type	UP005 to UP012 type	UP015 type	UP018 type	Setup of high ceiling
Discharge direction	4-way	4-way	4-way	Set data
Standard (Factory default)	2.7	2.9	3.5	0000
High ceiling (1)	—	3.2	—	0001
High ceiling (3)	—	3.5	—	0003

### REQUIREMENT

When high ceiling (1) or (3) is used with 4-way blowing, a draft is easily recognized due to drop of discharge temperature.

The lighting time of the filter sign (notification of filter cleaning) on the remote controller can be changed according to installation conditions.

When it is difficult to obtain satisfactory heating due to location place of the indoor unit or the structure of the room, the detection temperature of heating can be raised.

Refer to "8. Applicable controls" in this manual for the setting procedure.

# 4 Installation

## REQUIREMENT

- Strictly comply with the following rules to prevent damage of the indoor units and human injury.
- Do not put any heavy article on the indoor unit. (Even units are packaged)
  - Carry in the indoor unit as it is packaged if possible. If carrying in the indoor unit unpacked by necessity, use buffering cloth or other soft cloth to not damage the unit.
  - To move the indoor unit, hold the hooking metals (4 positions) only.  
Do not apply force to the other parts (refrigerant pipe, drain pan, foamed parts, or resin parts).
  - Carry the package by two or more persons, and do not bundle it with plastic band at positions other than specified.

## External view

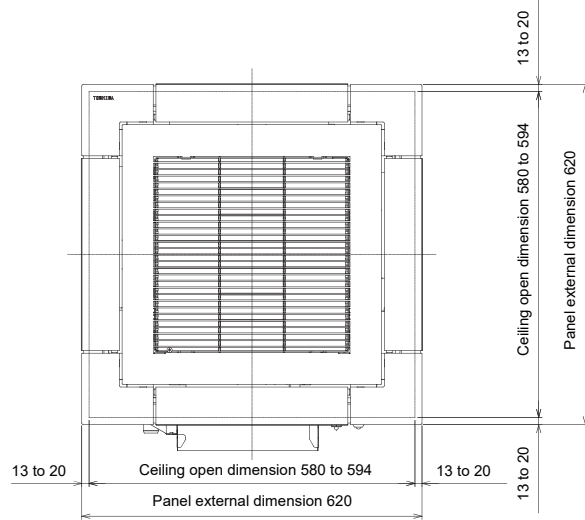

Unit: mm

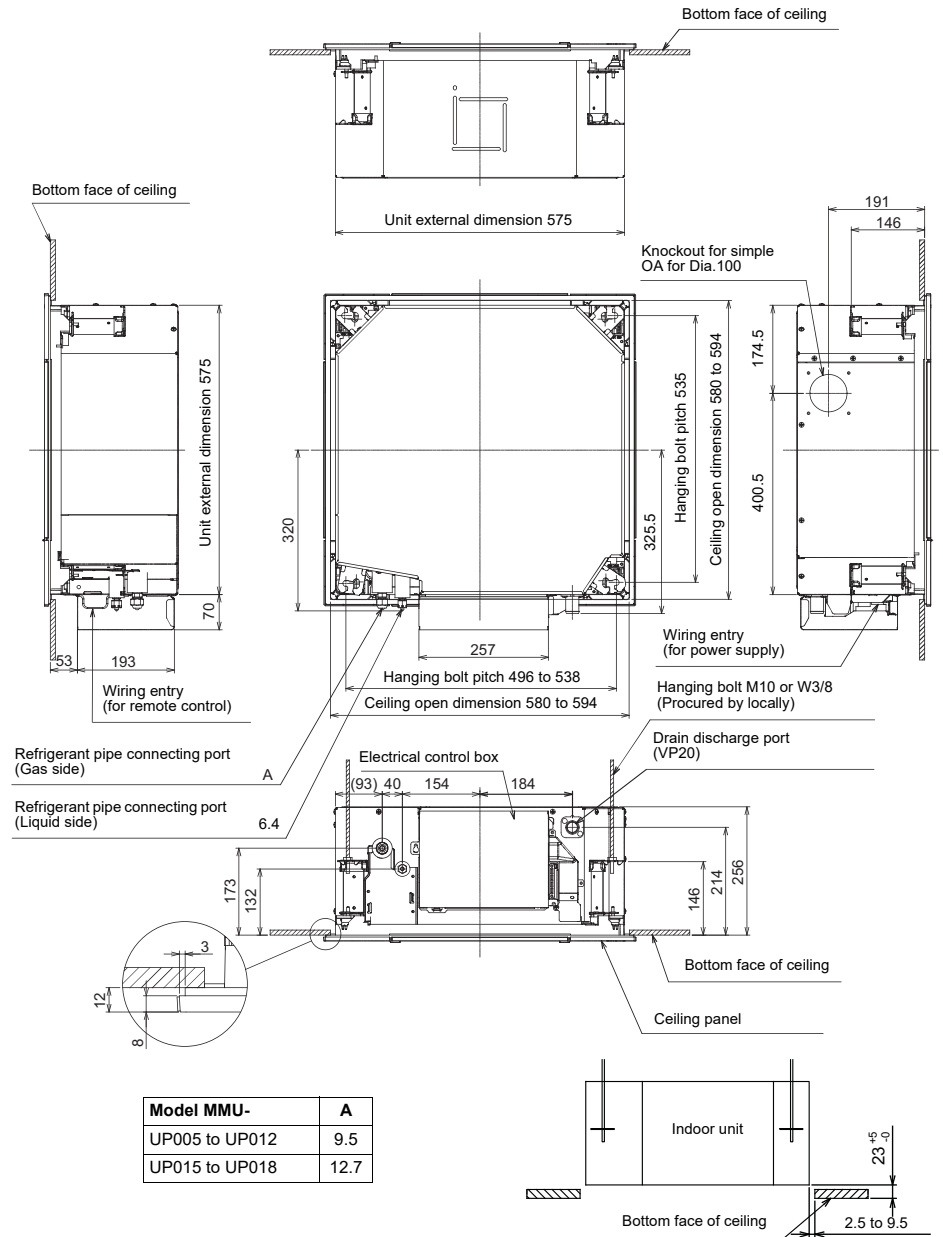

Model MMU-	A
UP005 to UP012	9.5
UP015 to UP018	12.7

## ■ Opening a ceiling and installation of hanging bolts

- Consider the piping / wiring after the unit is hung to determine the location of the indoor unit installation and orientation.
- After the location of the indoor unit installation has been determined, open the ceiling and install hanging bolts.
- The dimensions of the ceiling opening and hanging bolt pitches are given in the outline drawing and the attached installation pattern.
- When a ceiling already exists, lay the drain pipe, refrigerant pipe, control wires, and remote controller wires to their connection locations before hanging the indoor unit.

Procure hanging bolts and nuts for installing the indoor unit (these are not supplied).

Hanging bolt	M10 or W3/8	4 pieces
Nut	M10 or W3/8	12 pieces

### Using the installation pattern (accessory)

The installation pattern is provided inside the packaging cap.

#### <For existing ceiling>

Use the installation pattern positioning a ceiling opening and hanging bolts.

#### <For new ceiling>

Use the installation pattern to position the ceiling opening when a ceiling is hanged.

- After the hanging bolts have been installed, install the indoor unit.
- After loosening the panel fixing screws of the indoor unit, hook them on the four holes in the installation pattern.
- When hanging a ceiling, open the ceiling along the outside dimensions of the installation pattern.

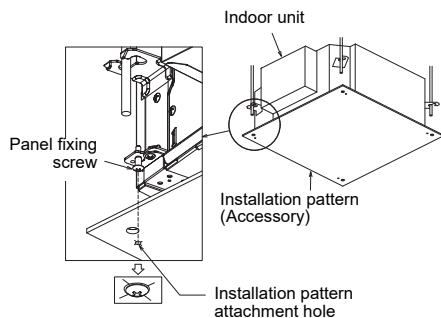

### Treatment of ceiling









The ceiling differs according to structure of building. For details, consult your constructor or interior finish contractor.

In the process after the ceiling board has been removed, it is important to reinforce ceiling foundation (frame) and to keep horizontal level of installed ceiling correctly in order to prevent vibration of ceiling board.

- Cut and remove the ceiling foundation.
- Reinforce the cut surface of ceiling foundation, and add ceiling foundation for fixing the end of ceiling board.

### Installation of hanging bolt

Use M10 hanging bolts (4 pcs, locally procured). Matching to the existing structure, set pitch according to size in the unit external view as shown below.

New concrete slab	
Install the bolts with insert brackets or anchor bolts.	
	
(Blade type bracket)	(Slide type bracket)
	
Anchor bolt	Pipe hanging anchor bolt
* Rubber	
Steel flame structure	
Use existing angles or install new support angles.	
	
Hanging bolt	Support angle
Existing concrete slab	
Use a hole-in anchors, hole-in plugs, or a hole-in bolts.	
	

### Installation of ceiling opening and hanging bolt

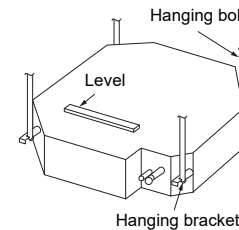

- Attach a nut (locally procured) and the washer (accessory) to each hanging bolt.
- Insert a washer on both sides of the T groove of the hanging bracket of the indoor unit, and hang the indoor unit.
- Check that the four sides of the indoor unit are level using a level gauge (levelness: 5 mm or less).
- Detach the installation gauge (accessory) from the installation pattern.
- Using the installation gauge, check and adjust the positional relation between the indoor unit and the ceiling opening (1) (2.5 - 9.5 mm: 4 sides) and the hanging-up height (2) (23 - 28 mm: 4 corners). (How to use the installation gauge is printed on the gauge.)

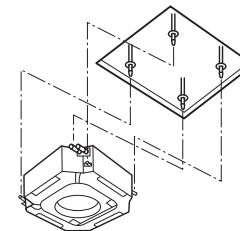
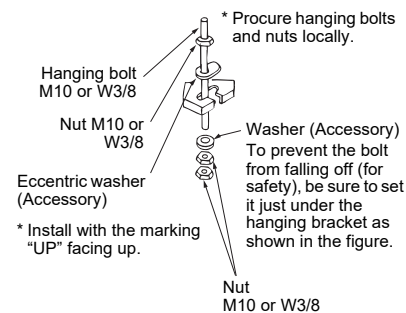

For the grid ceiling, incline the unit and then mount the unit from the electrical control box side as shown in the figure below.

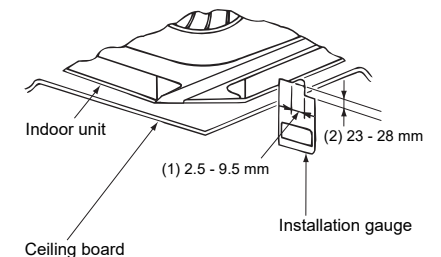
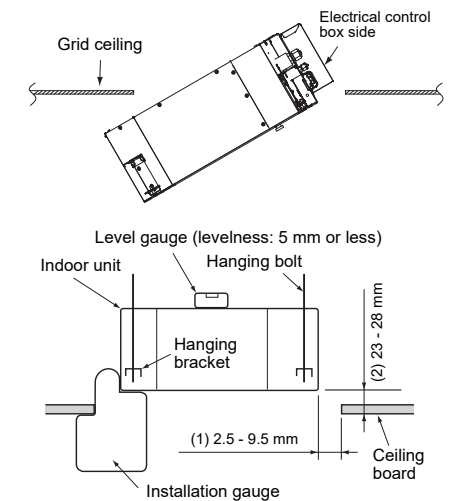

### CAUTION

Before installation of the indoor unit, remove the tape that holds the fan and bell mouth. Running the unit without removing the tape may damage the fan motor.

### ■ Installation of ceiling panel (Sold separately)

Install the ceiling panel according to Installation Manual attached with it after piping / wiring work has completed.

Check that installation of indoor unit and ceiling opening part is correct, and then install it.

#### REQUIREMENT

- Joint the connecting sections of ceiling panel, ceiling surface, ceiling panel and indoor unit closely. Any gap between them will cause air leakage and the generate condensation or water leakage.
- Remove the adjust corner caps at the four corners of the ceiling panel, and then install the ceiling panel onto the indoor unit.

### ■ Installation of remote controller (Sold separately)

For installation of the wired remote controller, follow the Installation Manual attached with the remote controller.

- Pull out the remote controller wire together with the refrigerant pipe or drain pipe. Pass the remote controller wire through upper side of the refrigerant pipe and drain pipe.
- Do not leave the remote controller at a place exposed to the direct sunlight and near a stove.

### ■ Installation of wireless remote controller (Sold separately)

The signal receiving unit of indoor unit can receive a signal by distance within approx. 7 m. Based upon it, determine a place where the remote controller is operated and the installation place.

- Operate the remote controller, confirm that the indoor unit receives a signal surely, and then install it.
- Keep 1 m or more from the devices such as television. (Disturbance of image or noise may generate.)
- To prevent a malfunction and reception failure of the remote controller, select a place where it is not influenced by a fluorescent light, equipment (Electronic whiteboard etc.) emitting infrared rays, or direct sunlight.
- Switching the setting (A-B selection) of the wireless remote controllers and the signal receiving unit enables two indoor units installed in a room to be respectively operated using two wireless remote controllers.

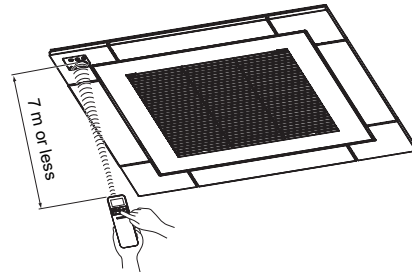

## 5 Drain piping

### ⚠ CAUTION

Following the Installation Manual, perform the drain piping work so that water is properly drained, and apply a heat insulation so as not to cause a dew drop.

**Inappropriate piping work may result in water leakage in the room and wet of furniture.**

### ■ Piping / Heat insulating material

Require the following materials for piping and heat insulating at site.

<b>Piping</b>	Hard vinyl chloride pipe VP20 (Outer dia.: 26 mm)
<b>Heat insulator</b>	Foam polyethylene: Thickness 10 mm or more

### ■ Flexible hose

Use the attached flexible hose to adjust centre discrepancy of the hard vinyl chloride pipe.

- Do not use the flexible hose as stretched, or do not deform.
- Fix the soft end of the flexible hose with the attached hose band.
- Use the flexible hose on a horizontal level.

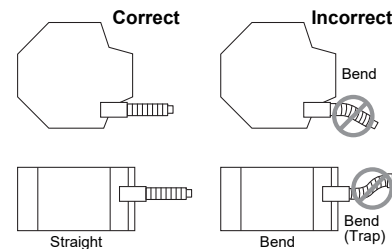

### REQUIREMENT

- Perform heat insulation of the drain pipes of the indoor unit.
- Perform heat insulation of the connecting part with the indoor unit. An incomplete heat insulation causes dew drop.
- Set the drain pipe with downward slope (1/100 or more), and do not make swelling or trap on the piping. It may cause an abnormal sound.
- For length of the traversing drain pipe, restrict to 20 m or less. In case of a long pipe, provide support brackets with interval of 1.5 - 2 m in order to prevent waving.

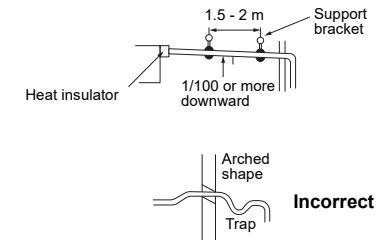

- Set the collective piping as shown in the below figure.

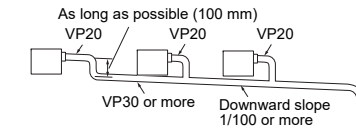

- Do not apply force to the connecting part of the drain pipe.
- The hard vinyl-chloride pipe cannot be directly connected to the drain pipe connecting port of the indoor unit. For connection with the drain pipe connecting port, fix the attached flexible hose with the hose band, otherwise a damage or water leak is caused on the drain pipe connecting port.

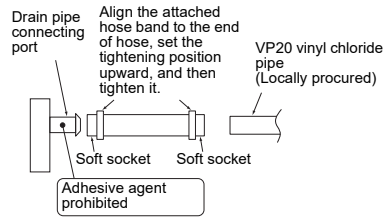

- Adhesive agent cannot be used for the pipe connecting port (Soft socket) of the indoor unit. Be sure to use the attached hose band for fixing, otherwise damage or water leakage of the drain pipe connecting port is caused.

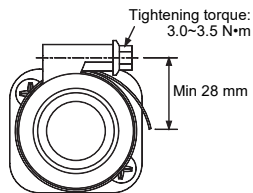
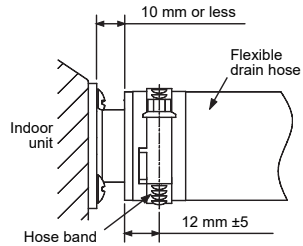

## ■ Connecting drain pipe

- Connect VP20 hard vinyl chloride pipe (Locally procured) to flexible drain hose using attached hose band.

## ■ Drain up

When a down-gradient cannot be secured for the drainpipe, drain-up piping is possible.

- The height of the drain pipe must be 850 mm or less from the bottom of the ceiling.
- Take the drain pipe out of the drain pipe joint with the indoor unit in 300 mm or less, and bend up the pipe vertically.
- Immediately after the pipe is bent up vertically, lay the pipe making a down-gradient.
- Set downward grading immediately after raising up vertically.

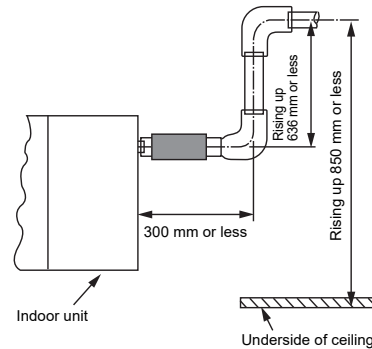

## ■ Check the draining

In the test run, check that water drain is properly performed and water does not leak from the connecting part of the pipes.

Check draining also when installed in heating period. By using a pitcher or hose, pour water (1500 - 2000 cc) into the discharge port before installation of the ceiling panel.

Pour water gradually so that water does not spread on the motor of the drain pump.

### ⚠ CAUTION

Pour water gently so that it does not spread around inside the indoor unit, which may cause a malfunction.

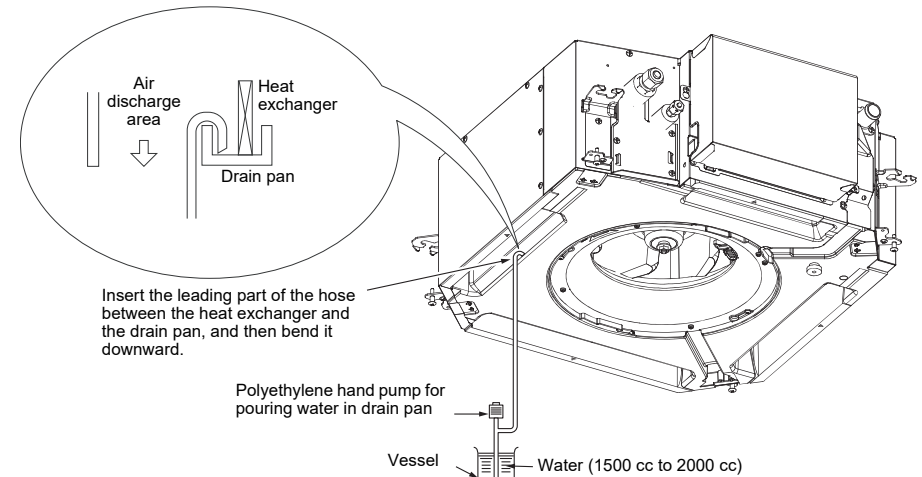

- After the electric work has finished, pour water during COOL mode operation.
- If the electric work has not yet finished, pull out the float switch connector (CN34: Red) from the electrical control box, and check draining by plugging the single phase 208 V to 240 V power to the terminal blocks (L) and (N). If doing so, the drain pump motor operates. (Never apply 208 V to 240 V to (Uv (U1)), (Uv (U2)), (A), (B), otherwise a trouble of P.C. board occurs.)
- Test water drain while checking the operation sound of the drain pump motor. (If the operation sound changes from continuous sound to intermittent sound, water is normally drained.) After the check, the drain pump motor runs, connecting the float switch connector. (In case of check by pulling out the float switch connector, be sure to return the connector to the original position.)

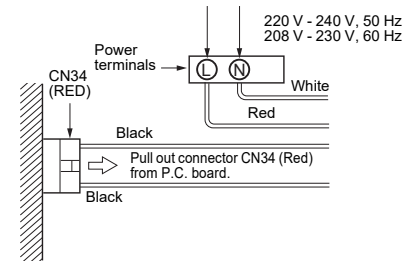

## ■ Perform heat insulating

- As shown in the figure, cover the flexible hose and hose band with the attached heat insulator up to the bottom of the indoor unit without gap.
- Cover the drain pipe seamlessly with a heat insulator to be procured locally so that it overlaps with the attached heat insulator of the drain connecting section.

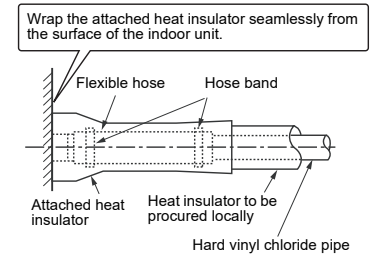

- Direct the slits and seams of the heat insulator upward to avoid water leakage.

# 6 Refrigerant piping

## CAUTION

Use flare nuts that are included with the unit. Using different flare nuts may cause refrigerant gas leakage.

## Refrigerant piping

Use the following item for the refrigerant piping.

**Material: Seamless phosphorous deoxidized copper pipe.**

**6.35, 9.52 and 12.7 wall thickness 0.8 mm or more. 15.88 wall thickness 1.0 mm or more.**

### REQUIREMENT

When the refrigerant pipe is long, provide support brackets at intervals of 2.5 - 3 m to clamp the refrigerant pipe. Otherwise, abnormal sound may be generated.

## CAUTION

### IMPORTANT 4 POINTS FOR PIPING WORK

1. Reusable mechanical connectors and flared joints are not allowed indoors. When mechanical connectors are reused indoors, sealing parts shall be renewed. When flared joints are reused indoors, the flare part shall be refabricated.
2. Tight connection (between pipes and unit)
3. Evacuate the air in the connecting pipes by using VACUUM PUMP.
4. Check the gas leakage. (Connected points)

## Pipe size

Model MMU-	Outside diameter size (mm)	
	Gas side	Liquid side
UP005 to UP012	9.5	6.4
UP015, UP018	12.7	6.4

## Permissible piping length and height difference

They vary according to the outdoor unit. For details, refer to the Installation Manual attached to the outdoor unit.

### Flaring

1. Cut the pipe with a pipe cutter. Remove burrs completely. Remaining burrs may cause gas leakage.
2. Insert a flare nut into the pipe, and flare the pipe. As the flaring sizes of R410A differ from those of refrigerant R22, the flare tools newly manufactured for R410A are recommended. However, the conventional tools can be used by adjusting projection margin of the copper pipe.

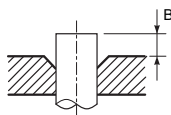

### Projection margin in flaring: B (Unit: mm)

Rigid (Clutch type)

Outside diameter size (mm)	R410A tool used	Conventional tool used
6.4, 9.5	0 - 0.5	1.0 - 1.5
12.7, 15.9		

### Flaring dia. meter size: A (Unit: mm)

Outside diameter size (mm)	A <sup>+0</sup> <sub>-0.4</sub>
6.4	9.1
9.5	13.2
12.7	16.6
15.9	19.7

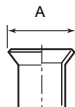

## CAUTION

- Do not scratch the inner surface of the flared part when removing burrs.
- Flare processing under the condition of scratches on the inner surface of flare processing part will cause refrigerant gas leak.
- Check that the flared part is not scratched, deformed, stepped, or flattened, and that there are no chips adhered or other problems, after flare processing.
- Do not apply refrigerating machine oil to the flare surface.

## Tightening connection

## CAUTION

Do not apply excessive torque. Otherwise, the nut may crack depending on the conditions.

Unit: N•m

Outside diameter size (mm)	Tightening torque
6.4 mm	14 - 18
9.5 mm	34 - 42
12.7 mm	49 - 61
15.9 mm	68 - 82

### Tightening torque of flare pipe connections

Incorrect connections may cause not only a gas leak, but also a trouble of the refrigeration cycle.

Align the centres of the connecting pipes and tighten the flare nut as far as possible with your fingers. Then tighten the nut with wrenches and torque wrench as shown in the figure.

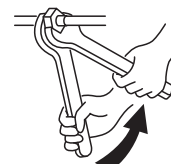

Work using two wrenches

### REQUIREMENT

Tightening with an excessive torque may crack the nut depending on installation conditions.

Tighten the nut within the specified tightening torque.

## Airtight test / Air purge, etc.

For air tightness test, vacuum drying and adding refrigerant, refer to the Installation Manual attached to the outdoor unit.

## CAUTION

Do not supply power to the indoor unit until the airtight test and vacuuming are completed. (If the indoor unit is powered on, the pulse motor valve is fully closed, which extends the time for vacuuming.)

## Open the valve fully

Open the valve of the outdoor unit fully.

## Heat insulation process

Apply heat insulation for the pipes separately at liquid side and gas side.

- For the heat insulation to the pipes at gas side, use the material with heat-resisting temperature 120 °C or higher.
- To use the attached heat insulation pipe, apply the heat insulation to the pipe connecting section of the indoor unit securely without gap.

### REQUIREMENT

- Apply the heat insulation to the pipe connecting section of the indoor unit securely up to the root without exposure of the pipe. (The pipe exposed to the outside causes water leak.)
- Wrap heat insulator with its slits facing up (ceiling side).

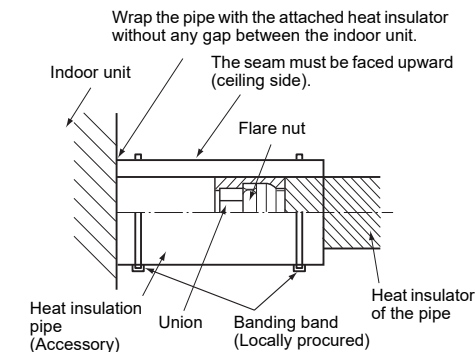

# 7 Electrical connection

## ⚠ WARNING

- Use the specified wires for wiring connection to the terminals. Securely fix them to prevent external forces applied to the terminals from affecting the terminals.  
Incomplete connection or fixation may cause a fire or other trouble.
- Connect earth wire. (grounding work)  
Incomplete earthing cause an electric shock.  
Do not connect earth wires to gas pipes, water pipes, lightning conductor or telephone earth wires.
- Appliance shall be installed in accordance with national wiring regulations.  
Capacity shortage of power circuit or incomplete installation may cause an electric shock or a fire.

## ⚠ CAUTION

- The wire size and wire length of the communication line differs depending on the outdoor unit series to be connected.
- If incorrect / incomplete wiring is carried out, it will cause an electrical fire or smoke.
- Install an earth leakage breaker that is not tripped by shock waves.  
If an earth leakage breaker is not installed, an electric shock may be caused.
- Use the cord clamps attached to the product.
- Do not damage or scratch the conductive core and inner insulator of power and control wires when peeling them.
- Use the power supply wire and control wires of specified thickness, type, and protective devices required.
- Do not connect 208 V to 240 V power to the terminal blocks (Uv (U1)), (Uv (U2)), (A), (B) for control wiring.  
(Otherwise, the system will fail.)
- Perform the electric wiring so that it does not come to contact with the high-temperature part of the pipe.  
The coating may melt resulting in an accident.

## REQUIREMENT

- For power supply wiring, strictly conform to the Local Regulation in each country.
- For wiring of power supply of the outdoor units, follow the Installation Manual of each outdoor unit.
- After connecting wires to the terminal blocks, provide a trap and fix wires with the cord clamp.
- Run the refrigerant piping line and communication line in the same line.
- Do not turn on the power of the indoor unit until vacuuming of the refrigerant pipes completes.

## ■ Power supply wire and communication wires specifications

Power supply wire and communication wires are locally procured.

For the power supply specifications, follow to the table below. If capacity is little, it is dangerous because overheat or burnout may be caused.

For specifications of the power capacity of the outdoor unit and the power supply wires, refer to the Installation Manual attached to the outdoor unit.

### Indoor unit power supply

- For the power supply of the indoor unit, prepare the exclusive power supply separated from that of the outdoor unit.
- Arrange the power supply, circuit breaker, and main switch of the indoor unit connected to the same outdoor unit so that they are commonly used.
- Power supply wire specification: Cable 3-core 2.5 mm<sup>2</sup>, in conformity with Design 60245 IEC 57.

## ■ Power supply

Power supply	220 V - 240 V, 50 Hz 208 V - 230 V, 60 Hz	
Power supply switch / circuit breaker or power supply wiring / fuse rating for indoor units should be selected by the accumulated total current values of the indoor units.		
Power supply wiring	Below 50 m	3 × 2.5 mm <sup>2</sup> (power supply and earth)

### Control wiring, Central controller wiring

- 2-core with non-polarity wires are used for the Control wiring between indoor unit and outdoor unit and Central controller wiring.
- To prevent noise trouble, use 2-core shield wire.

## ■ Communication line

TU2C-Link models (U series) can be combined with TCC-Link models (other than U series).

For details of communication type, refer to the following table.

### Communication type and model names

Communication type	TU2C-Link (U series and future models)	TCC-Link (Other than U series)
Outdoor unit	MMY-MUP*** ↑ This letter indicates U series model.	Other than U series MMY-MAP*** MCY-MHP***
Indoor unit	MM*-UP*** ↑ This letter indicates U series model.	Other than U series MM*-AP***
Wired remote controller	RBC-A**U*** ↑ This letter indicates U series model.	Other than U series
Wireless remote controller kit & receiver unit	RBC-AXU*** ↑ This letter indicates U series model.	Other than U series
Remote sensor	TCB-TC**U*** ↑ This letter indicates U series model.	Other than U series

U series outdoor unit: SMMS-u (MMY-MUP\*\*\*)

Other than U series outdoor unit: SMMS-i, SMMS-e etc. (MMY-MAP\*\*\*)

**<In the case of combining with outdoor units of Super Modular Multi System u series (SMMS-u)>**

Follow the wiring specifications in the table below even when units other than U series are mixed in the indoor units and remote controllers to be connected.

<b>Uv line and Uc line (L2, L3, L4)</b> (2-core shield wire, non-polarity)	Wire size: 1.0 to 1.5 mm <sup>2</sup> (Up to 1000 m)
<b>Uh line (L1)</b> (2-core shield wire, non-polarity)	Wire size: 1.0 to 1.5 mm <sup>2</sup> (Up to 1000 m) 2.0 mm <sup>2</sup> (Up to 2000 m)

- **U (v, h, c)** line means of control wiring.
  - Uv line:** Between indoor and outdoor units.
  - Uh line:** Central control line.
  - Uc line:** Between outdoor and outdoor units.
- **Uv line and Uc line** are independent from another refrigerant line. Total length of **Uv** and **Uc** lines (**L3 + L4**) in each refrigerant line is up to 1000 m.

**REQUIREMENT**

For connection of Uv line / Uc line or Uh line, wire each line using wires with the same type and size. If different wire types and size are mixed and used in a system, communication trouble is caused.

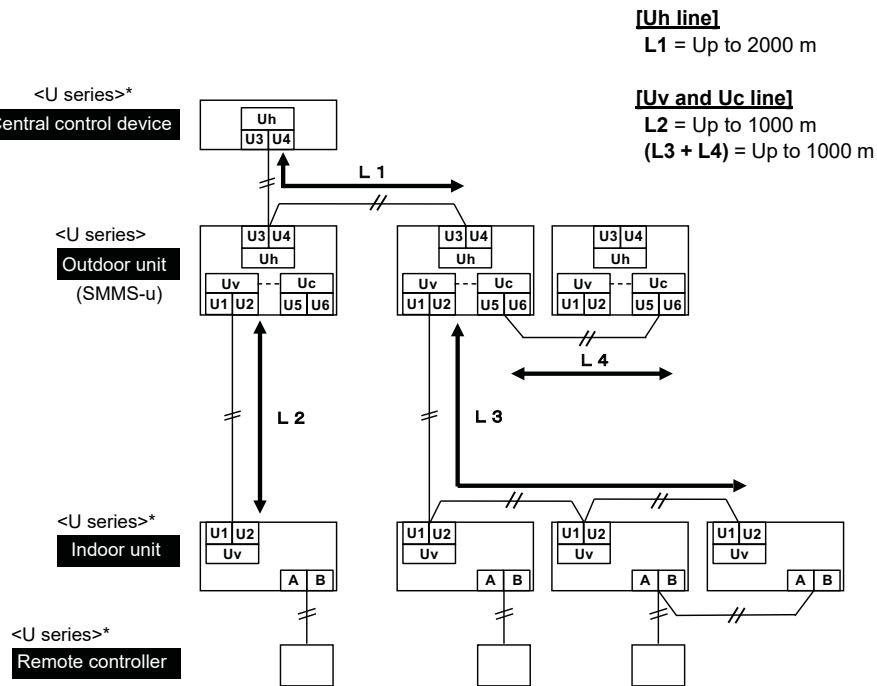

\*Even if the indoor units, the remote controllers, and the central control device are models other than U series, their system diagrams for the wiring specifications are the same as the system diagram above.

**<In the case of combining with outdoor units other than Super Modular Multi System u series (SMMS-u)>**

Control wiring between indoor units, and outdoor unit ( <b>L2, L3</b> ) (2-core shield wire, non-polarity)	Wire size: 1.25 mm <sup>2</sup> (Up to 1000 m)
Central control line wiring ( <b>L1</b> ) (2-core shield wire, non-polarity)	Wire size: 2.0 mm <sup>2</sup> (Up to 2000 m)
Control wiring between outdoor units ( <b>L4</b> ) (2-core shield wire, non-polarity)	Wire size: 1.25 to 2.0 mm <sup>2</sup> (Up to 100 m)

- The length of the communication line (L1+L2+L3) means the total length of the inter-unit wire length between indoor and outdoor units added with the central control system wire length.

**REQUIREMENT**

For connection of between indoor and outdoor units line / between outdoor and outdoor units line or central control line, wire each line using wires with the same type and size. If different wire types and size are mixed and used in a system, communication trouble is caused.

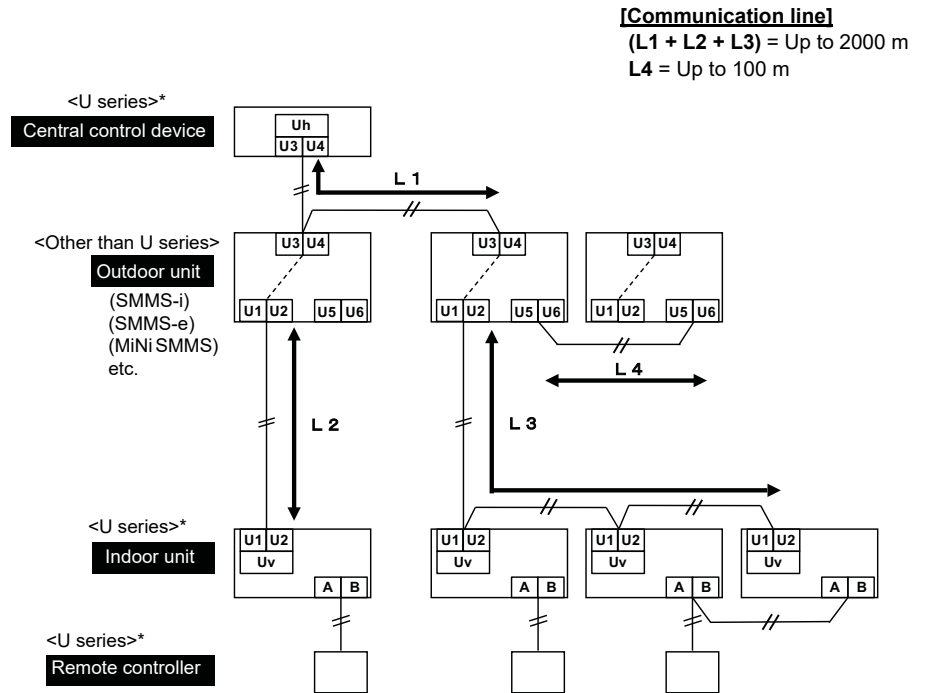

\*Even if the indoor units, the remote controllers, and the central control device are models other than U series, their system diagrams for the wiring specifications are the same as the system diagram above.



## Remote controller wiring

- 2-core with non-polarity wire is used for the remote controller wiring and group remote controllers wiring.

Remote controller wiring, remote controller inter-unit wiring	Wire size: 0.5 mm <sup>2</sup> to 2.0 mm <sup>2</sup>	
Total wire length of remote controller wiring and remote controller inter-unit wiring = L + L1 + L2 + ... Ln	In case of one remote controller	Up to 500 m
	In case of two remote controller	Up to 400 m
Max. length of each remote control wiring between indoor units = L1, L2, ..., Ln	Up to 200 m	

### CAUTION

- The remote controller wire (Communication line) and AC 208 V to 240 V wires cannot be parallel to contact each other and cannot be stored in the same conduits. If doing so, a trouble may be caused on the control system due to noise or other factor.
- If U series models (TU2C-Link) are combined with models other than U series (TCC-Link), the wiring specifications and maximum number of connectable indoor units will be changed. Pay attentions to their communication specifications when carrying out the installation, maintenance, or repair. For its details, refer to the "Communication line" in 7 Electrical connection.

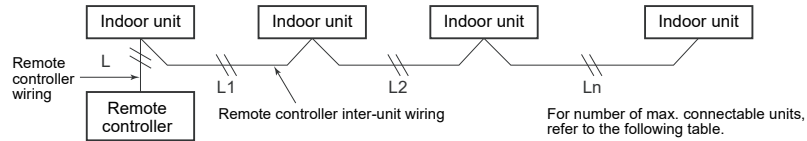

### Max. number of connectable indoor units, and communication type

Outdoor unit	Unit type							
	U series	U series	U series	U series	*	*	*	*
Indoor unit	U series	U series	*	*	U series	U series	*	*
Remote controller	U series	*	U series	*	U series	*	U series	*
Remote sensor	U series	*	U series	*	U series	*	U series	*
Communication type	TU2C-Link				TCC-Link			
Max. number of connectable units	16				8			

\*: Other than U series

### REQUIREMENT

After carrying out installation of additional indoor unit, relocation, or repairing, set the addresses again. For its detail, refer to the Installation Manual attached to the outdoor unit.

## Wiring between indoor and outdoor units

### NOTE

A wiring diagram below is an example for connection to SMMS-u series. For connecting to other outdoor unit series, refer to the Installation Manual attached to the outdoor unit to be connected.

### Wiring example

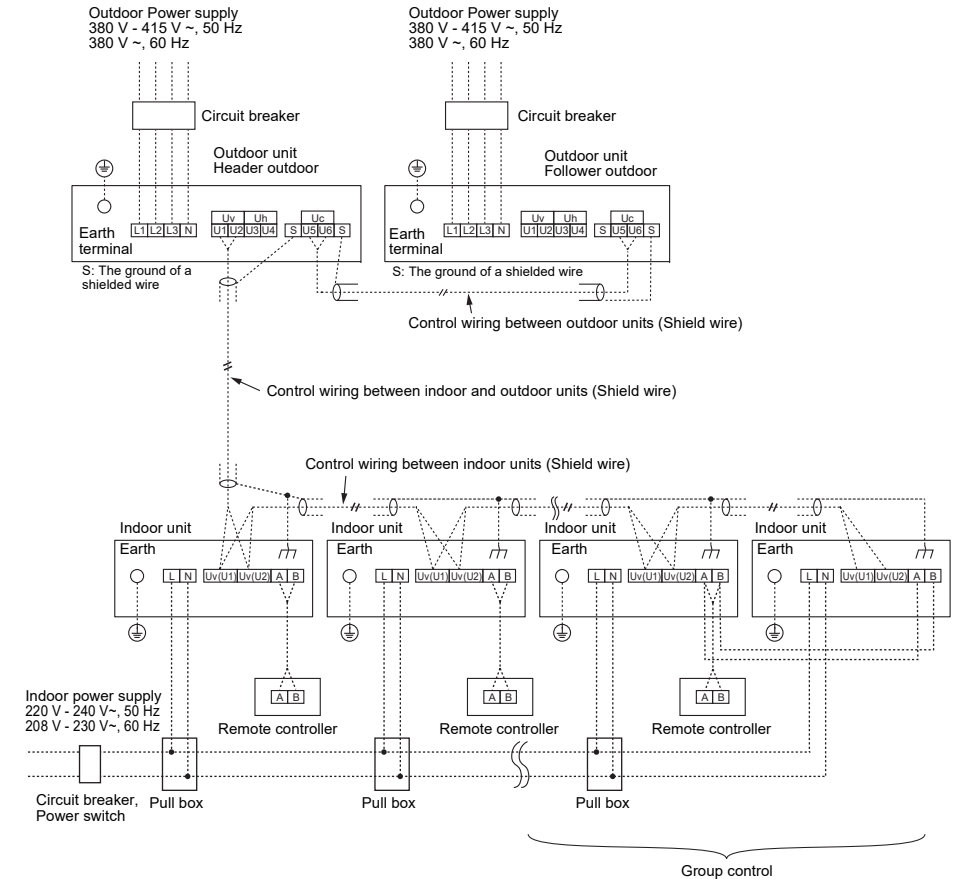

## ■ Wire connection

### REQUIREMENT

- Connect the wires matching the terminal numbers. Incorrect connection causes a trouble.
- Route the wire through the wire connection port of the indoor unit.
- The low-voltage circuit is provided for the control wire and remote controller wire. (Do not connect the high-voltage circuit.)

1. Loosen the two screws, and remove the cover of electrical control box by sliding in the direction of the arrow.
2. Connect the power supply wire, communication wires and remote controller wire to the terminal block of the electrical control box.
3. Tighten the screws of the terminal block, and fix the wires with cord clamp attached to the electrical control box. (Do not apply tension to the connecting section of the terminal block.)
4. Mount the cover of the electrical control box without pinching wires. (Mount the cover after wiring on the ceiling panel.)

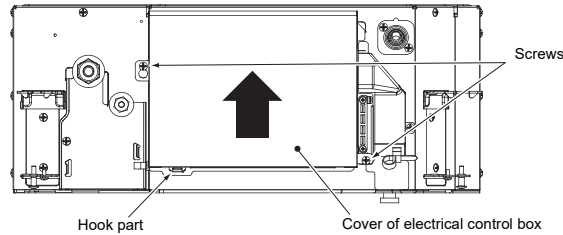

Select side C or D for the power supply wire clamping position, refer to the following table according to the cord type and diameter.  
 \* The cord clamp can be attached on either right or left side. Clamp two cords side-by-side for twin connection.

Wire type	Specification	Cord clamping position
Cabletyre cord	3-core stranded wire 2.5 mm <sup>2</sup>	Side D
Cabletyre cord	2-core stranded wire 1.5 mm <sup>2</sup>	Side C

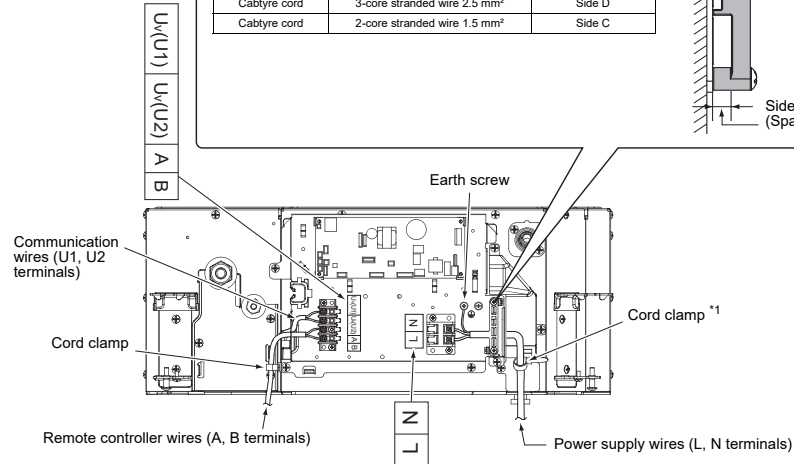
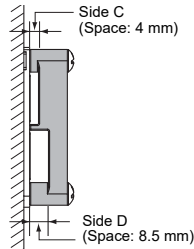

### ⚠ CAUTION

\*1 Make sure to fix the power supply wire with the cord clamp so that no water enters into the electrical control box through the power supply wire.

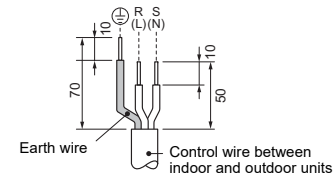
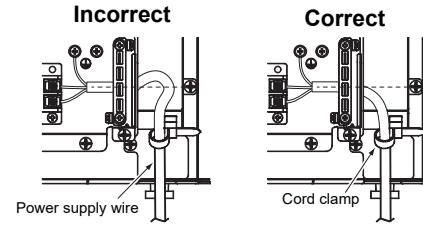

## ■ Wiring on the ceiling panel

According to the Installation Manual of the ceiling panel, connect the louver motor connector on the ceiling panel side and the louver motor connector on the indoor unit side.

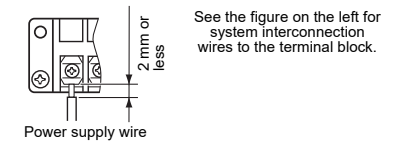
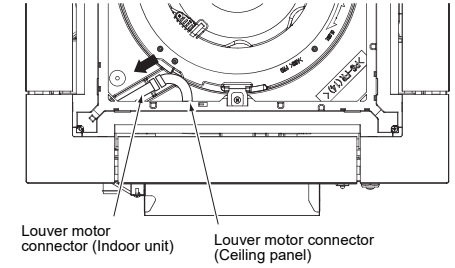

## ■ Remote controller wiring

Strip off approx. 9 mm the wire to be connected.

### Wiring diagram

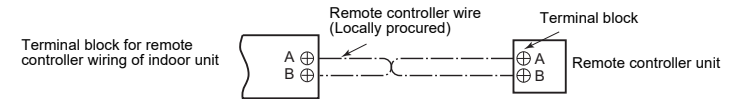

## ■ Address setup

Set up the addresses as per the Installation Manual supplied with the outdoor unit.

## ■ Wiring on the ceiling panel

According to the Installation Manual of the ceiling panel, connect the connector (20P: White) of the ceiling panel to the connector (CN510: White) on P.C. board of the electrical control box.

# 8 Applicable controls

## REQUIREMENT

When the air conditioner is used for the first time, it will take some moments after the power has been turned on before the remote controller becomes available for operations: This is normal and is not indicative of trouble.

- Concerning the automatic addresses (The automatic addresses are set up by performing operations on the outdoor interface circuit board.)

While the automatic addresses are being set up, no remote controller operations can be performed. Setup takes up to 10 minutes (usually about 5 minutes).

- When the power is turned on after automatically address setup, it takes up to 10 minutes (usually about 3 minute) for the outdoor unit to start operating after the power has been turned on.

Before the air conditioner was shipped from the factory, all units are set to [STANDARD] (factory default). If necessary, change the indoor unit settings.

The settings are changed by operating the wired remote controller.

- The settings cannot be changed using only a wireless remote controller and simple remote controller by itself so install a wired remote controller separately as well.

## ■ Applicable controls setup (settings at the site)

Remote controller model name:

RBC-ASCU11-\*

### Basic procedure

Be sure to stop the air conditioner before making settings.

(Change the setup while the air conditioner is not working.)

### ⚠ CAUTION

Set only the Code No. shown in the following table: Do NOT set any other Code No.

If a Code No. not listed is set, it may not be possible to operate the air conditioner or other trouble with the product may result.

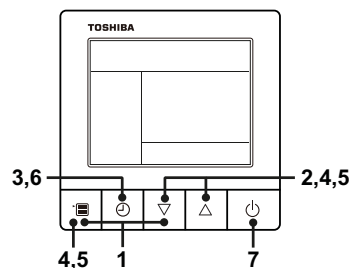

### 1 Push and hold menu button and [▽] setting button simultaneously for 10 seconds or more.

- After a while, the display flashes as shown in the figure. "ALL" is displayed as indoor unit numbers during initial communication immediately after the power has been turned on.

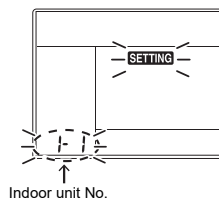

### 2 Each time [▽][△] setting button is pushed, indoor unit numbers in the group control change cyclically. Select the indoor unit to change settings for.

- The fan of the selected indoor unit runs and the louvers start swinging. The indoor unit can be confirmed for which to change settings.

### 3 Push OFF timer button to confirm the selected indoor unit.

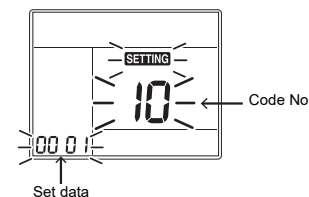

### 4 Push the menu button to make Code No. [\*\*] flash. Change Code No. [\*\*] with [▽][△] setting button.

### 5 Push the menu button to make Set data [\*\*\*\*] flash. Change Set data [\*\*\*\*] with [▽][△] setting button.

### 6 Push OFF timer button to complete the set up.

- To change other settings of the selected indoor unit, repeat from Procedure 4.

### 7 When all the settings have been completed, push ON/OFF button to finish the settings. (Return to the normal mode)

"SETTING" flashes and then the display content disappears and the air conditioner enters the normal stop mode. (The remote controller is unavailable while "SETTING" is flashing.)

- To change settings of another indoor unit, repeat from Procedure 1.

## ■ Installing indoor unit on high ceiling

When an indoor unit is installed on a ceiling higher than the standard height, make the high ceiling setting for fan speed adjustment.

Follow to the basic operation procedure

(1 → 2 → 3 → 4 → 5 → 6 → 7).

- Specify [5d] for the Code No. in Procedure 4.
- Select the set data for Procedure 5 from the "Height list of ceiling possible to be installed" table in this manual.

Set data	Ceiling height
0000	Standard (Factory default)
0001	High ceiling (1)
0003	High ceiling (3)

### Remote controller-less setting

Change the high-ceiling setting with the DIP switch on the P.C. board.

- Once the Set data has been changed, though it can be freely set to 0001 or 0003, to reset it to 0000 (factory default), it need changing using remote controller (sold separately). After set data change, an air conditioner is operated. After setting has been completed, restart the air conditioner.

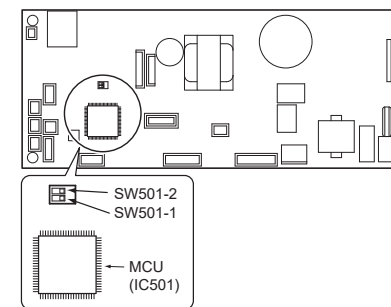

Set data	Ceiling height	SW501-1	SW501-2
0000	Standard (Factory default)	OFF	OFF
0001	High ceiling (1)	ON	OFF
0003	High ceiling (3)	OFF	ON

## ◆ To restore the factory defaults

To return the DIP switch settings to the factory defaults, set SW501-1 and SW501-2 to OFF, connect a separately sold wired remote controller, and then set the data of Code No. [5d] to "0000".

## ■ To secure better effect of heating

When it is difficult to obtain satisfactory heating due to installation place of the indoor unit or structure of the room, the detection temperature of heating can be raised. Also use a circulator or other machinery to circulate heat air near the ceiling.

Follow to the basic operation procedure (1 → 2 → 3 → 4 → 5 → 6 → 7).

- Specify [06] for the Code No. in Procedure 4.
- For the set data in Procedure 5, select the set data of shift value of detection temperature to be set up from the following table.

Set data	Detection temperature shift value
0000	No shift
0001	+1°C
0002	+2°C (Factory default)
0003	+3°C
0004	+4°C
0005	+5°C
0006	+6°C

## ■ Filter sign setting

According to the installation condition, the filter sign term (Notification of filter cleaning) can be changed.

Follow to the basic operation procedure (1 → 2 → 3 → 4 → 5 → 6 → 7).

- Specify [01] for the Code No. in Procedure 4.
- For the set data in Procedure 5, select the set data of filter sign term from the following table.

Set data	Filter sign term
0000	None
0001	150 H
0002	2500 H (Factory default)
0003	5000 H
0004	10000 H

- The filter sign may be unavailable depending on the remote controllers.

## ■ How to set up swing type

The swing type of the louver can be selected.

Follow to the basic operation procedure

- (1 → 2 → 3 → 4 → 5 → 6 → 7).
- Specify [F0] for the Code No. in Procedure 4.
  - Select the following data for the set data in Procedure 5.

Swing set data	Swing of louvers
0001	Standard swing (Factory default)
0002	Dual swing
0003	Cycle swing

- About “Dual swing”**  
“Dual” means that louvers 01 and 03 are directed and swing in one direction and louvers 02 and 04 are directed and swing in the opposite direction. (When louvers 01 and 03 are directed downward, louvers 02 and 04 are directed horizontally.)
- About “Cycle swing”**  
The four louvers swing independently at respective timings.

### ⚠ CAUTION

Do not set the swing set data to “0000”.  
(This setting may cause a failure of the louvers.)

## ■ How to set up louver lock (No swing)

A position of the individual louvers (four directions) can be locked.

Follow to the basic operation procedure (1 → 2 → 3 → 4 → 5 → 6 → 7).

- Specify [F1], [F2], [F3], or [F4] for the Code NO. in Procedure 4.
- Select the following data for the set data in Procedure 5.

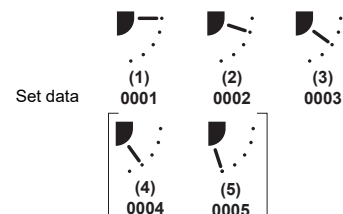

- When (4) or (5) is selected, dew drop may occur during cooling mode.
- When the setting has been determined, the light goes up.

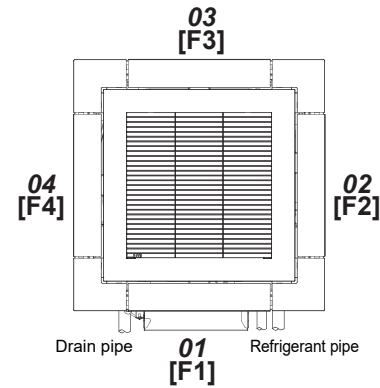

## ■ How to cancel louver lock

Set the wind direction to “0000” of the louver lock setup procedure above.



Setting data 0000

- When the setting is canceled, the light goes up. **Other operations are the same as those in “How to set up louver lock (No swing)”.**

## ■ To select horizontal wind direction

The louver positions at cooling can be changed from the smudge reducing position to the cold draftless position.

Follow to the basic operation procedure (1 → 2 → 3 → 4 → 5 → 6 → 7).

- For the Code No. in Procedure 4, specify [45].
- Select the following data for the set data in Procedure 5.

Wind direction set data	Wind direction setting
0000	Smudge reducing position (Air direction to reduce ceiling contamination) [Factory default]
0002	Cold draftless position (Air direction to control cold air fall)

## ■ Remote controller sensor

The temperature sensor of the indoor unit senses room temperature usually. Set the remote controller sensor to sense the temperature around the remote controller. Select items following the basic operation procedure (1 → 2 → 3 → 4 → 5 → 6 → 7).

- Specify [32] for the Code No. in Procedure 4.
- Select the following data for the set data in Procedure 5.

Set data	0000	0001
Remote controller sensor	Not in use (Factory default)	In use

When the light flashes, the remote controller sensor is defective.

Select the set data [0000] (not in use) or replace the remote controller.

## ■ Group control

In a group control, a remote controller can control up to maximum 8 or 16 units. (Depending on the outdoor unit.)

- The wired remote controller only can control a group control. The wireless remote controller is unavailable for this control.
- For wiring procedure and wires of the individual line (Identical refrigerant line) system, refer to “7. Electrical connection” in this Manual.
- Wiring between indoor units in a group is performed in the following procedure.
- Connect the indoor units by connecting the remote controller wires from the remote controller terminal blocks (A, B) of the indoor unit connected with a remote controller to the remote controller terminal blocks (A, B) of the other indoor unit. (Non-polarity)
- For address setup, refer to the Installation Manual attached to the outdoor unit.

# 9 Test run

## ■ Before test run

- Before turning on the circuit breaker, carry out the following procedure.
  - 1) By using insulation tester (500VMΩ), check that resistance of 1 MΩ or more exists between the terminal block L to N and the earth (grounding). If resistance of less than 1 MΩ is detected, do not run the unit.
  - 2) Check the valve of the outdoor unit being opened fully.
- To protect the compressor at activation time, leave power-ON for 12 hours or more for operating.
- Before starting a test run, be sure to set addresses following the Installation Manual supplied with the outdoor unit.

## ■ Execute a test run

Operate the unit with the remote controller as usual. For the procedure of the operation, refer to the Owner's Manual attached to the outdoor unit. A forced test run can be executed in the following procedure even if the operation stops by thermostat-OFF. In order to prevent a serial operation, the forced test run is released after 60 minutes have passed and returns to the usual operation.

### ⚠ CAUTION

- Do not use the forced test run for cases other than the test run because it applies an excessive load to the devices.

## Wired remote controller

Be sure to stop the air conditioner before making settings.

(Change the setup while the air conditioner is not working.)

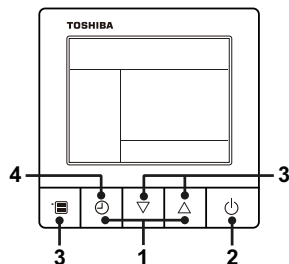

- 1 Push and hold OFF timer button and [△] setting button simultaneously for 10 seconds or more. [TEST] is displayed on the display part and the test run is permitted.

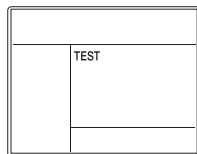

- 2 Push ON/OFF button.
- 3 Push menu button to select the operation mode. Select [Cool] or [Heat] with [▽] [△] setting button.
  - Do not run the air conditioner in a mode other than [Cool] or [Heat].
  - The temperature setting function does not work during test run.
  - The check code is displayed as usual.
- 4 After the test run, push OFF timer button to stop a test run. ([TEST] disappears on the display and the air conditioner enters the normal stop mode.)

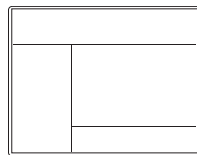

## Wireless remote controller

- 1 Turn on the power of the air conditioner. When power is turned on for the first time after installation, it takes approx. 5 minutes until the remote controller becomes available. In the case of subsequent power-on, it takes approx. 1 minute until the remote controller becomes available. Execute a test run after the predetermined time has passed.
- 2 Push "ON/OFF" button on the remote controller, select [Cool] or [Heat] with "MODE" button, and then select [HIGH] with "FAN" button.

3

Cooling test run	Heating test run
Set the temperature to 17°C with the temp. setup buttons.	Set the temperature to 30°C with the temp. setup buttons.

4

Cooling test run	Heating test run
After confirming a signal receiving sound "beep" immediately set the temperature to 18°C with the temp. setup buttons.	After confirming a signal receiving sound "beep" immediately set the temperature to 29°C with the temp. setup buttons.

5

Cooling test run	Heating test run
After confirming a signal receiving sound "beep" immediately set the temperature to 17°C with the temp. setup buttons.	After confirming a signal receiving sound "beep" immediately set the temperature to 30°C with the temp. setup buttons.

- 6 Repeat procedures 4 → 5 → 4 → 5. Indicators "Operation" (green), "Timer" (green), and "Ready" (orange) in the wireless receiver section flash in approx. 10 seconds, and the air conditioner starts operation. If any of these indicators does not flash, repeat procedures 2 to 5.

- 7 Upon completion of the test run, push "ON/OFF" button to stop operation.

<Overview of test run operations using the wireless remote controller>

▼ Cooling test run:  
ON/OFF → 17°C → 18°C → 17°C → 18°C → 17°C → 18°C → 17°C → (test run) → ON/OFF

▼ Heating test run:  
ON/OFF → 30°C → 29°C → 30°C → 29°C → 30°C → 29°C → 30°C → (test run) → ON/OFF

# 10 Maintenance

## <Daily maintenance>

### ▼ Cleaning of air filter

**1 Turn off the air conditioner.**  
Set the circuit breaker to OFF.

**2 Open the air intake grille.**

1) Loosen the fixing screw.

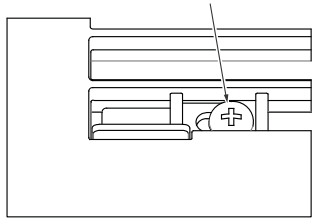

2) Slide the fixing bracket toward the inside.

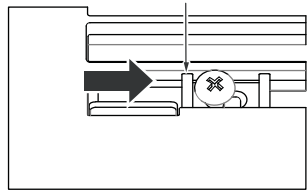

3) Holding the air intake grille, slide the hook in the direction of the arrow and slowly open the grille.

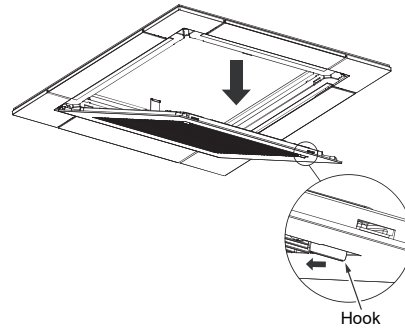
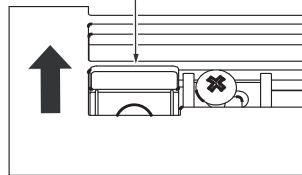

**3 Take out the air filter.**

• Push the extrusion of the air filter away from the grille and remove.

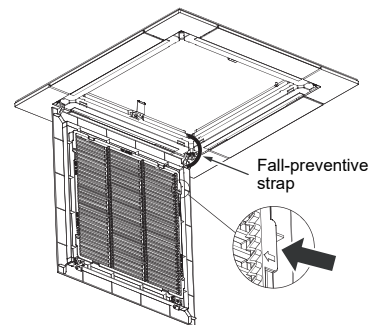

**4 Cleaning with water or vacuum cleaner.**

- If dirt is heavy, clean the air filter using tepid water with a neutral detergent or just water.
- After cleaning with water, dry the air filter sufficiently in a shaded place.



**5 Mount the air filter.**

**6 Close the air intake grille.**

- Check that the fall-preventive strap of the air intake grille is attached to the panel.
- In inverse process of 1, firmly attach the hook, fixing bracket and fixing screw.

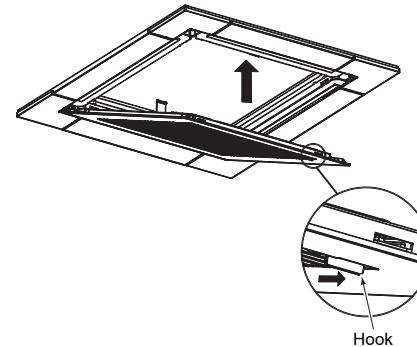

**7 Set the circuit breaker to ON.**

### ⚠ CAUTION

- Do not start the air conditioner while leaving air filter removed.

### ▼ Periodic Maintenance

- For environmental conservation, it is strongly recommended that the indoor and outdoor units of the air conditioner in use be cleaned and maintained regularly to ensure efficient operation of the air conditioner. When the air conditioner is operated for a long time, periodic maintenance (once a year) is recommended. Furthermore, regularly check the outdoor unit for rust and scratches, and remove them or apply rustproof treatment, if necessary.

As a general rule, when an indoor unit is operated for 8 hours or more daily, clean the indoor unit and outdoor unit at least once every 3 months. Ask a professional for this cleaning / maintenance work.

Such maintenance can extend the life of the product though it involves the owner's expense.

Failure to clean the indoor and outdoor units regularly will result in poor performance, freezing, water leakage, and even compressor failure.

### Inspection before maintenance

Following inspection must be carried out by a qualified installer or qualified service person.

Parts	Inspection method
Heat exchanger*	Open the air intake grille to remove the bell mouth and the fan, and then check the heat exchanger if there is any clogging or damages.
Fan motor	Check if any abnormal noise can be heard.
Fan	Open the air intake grille and check the fan if there are any waggles, damages or adhesive dust.
Filter	Open the air intake grille and check if there are any stains or breaks on the filter.
Drain pan*	Remove the panel, the bell mouth and the drain pan, and then check if there is any clogging, abnormal smell or drain water pollution.

\* Refer to the Service Manual for how to remove.

### ▼ Maintenance List

Part	Unit	Check (visual / auditory)	Maintenance
Heat exchanger	Indoor / outdoor	Dust / dirt clogging, scratches	Wash the heat exchanger when it is clogged.
Fan motor	Indoor / outdoor	Sound	Take appropriate measures when abnormal sound is generated.
Filter	Indoor	Dust / dirt, breakage	<ul style="list-style-type: none"> <li>Wash the filter with water when it is contaminated.</li> <li>Replace it when it is damaged.</li> </ul>
Fan	Indoor	<ul style="list-style-type: none"> <li>Vibration, balance</li> <li>Dust / dirt, appearance</li> </ul>	<ul style="list-style-type: none"> <li>Replace the fan when vibration or balance is terrible.</li> <li>Brush or wash the fan when it is contaminated.</li> </ul>
Air intake / discharge grilles	Indoor / outdoor	Dust / dirt, scratches	Fix or replace them when they are deformed or damaged.
Drain pan	Indoor	Dust / dirt clogging, drain contamination	Clean the drain pan and check the downward slope for smooth drainage.
Ceiling panel, louvres	Indoor	Dust / dirt, scratches	Wash them when they are contaminated or apply repair coating.
Exterior	Outdoor	<ul style="list-style-type: none"> <li>Rust, peeling of insulator</li> <li>Peeling / lift of coat</li> </ul>	Apply repair coating.

# 11 Troubleshooting

## ■ Confirmation and check

If a problem occurs with the air conditioner, the OFF timer indicator alternately shows the check code and the indoor Unit No. in which the problem occurred.

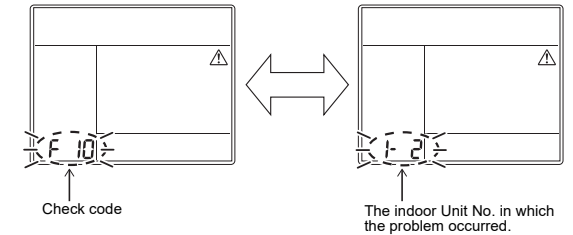

## ■ Troubleshooting history and confirmation

You can check the troubleshooting history with the following procedure if a problem occurs with the air conditioner. (The troubleshooting history records up to 4 incidents.)

You can check it during operation or when operation is stopped.

- If you check the troubleshooting history during OFF timer operation, the OFF timer will be canceled.

Procedure	Description of operation
1	<p>Push the OFF timer button for over 10 seconds and the indicators appear as an image indicating the troubleshooting history mode has been entered. If [ Service check] is displayed, the mode enters in the troubleshooting history mode.</p> <ul style="list-style-type: none"> <li>[01: Order of troubleshooting history] appears in the temperature indicator.</li> <li>The OFF timer indicator alternately shows the [check code] and the [indoor Unit No. ] in which the problem occurred.</li> </ul>
2	<p>Each time the setting button is pushed, the recorded troubleshooting history is displayed in sequence. The troubleshooting history appears in order from [01] (newest) to [04] (oldest).</p> <p><b>CAUTION</b></p> <ul style="list-style-type: none"> <li>In the troubleshooting history mode, DO NOT push the Menu button for over 10 seconds, doing so deletes the entire troubleshooting history of the indoor unit.</li> </ul>
3	<p>After you have finished checking, push the ON/OFF button to return to the regular mode.</p> <ul style="list-style-type: none"> <li>If the air conditioner is operating, it remains operated even after the ON/OFF button has been pushed. To stop its operation, push the ON/OFF button again.</li> </ul>

**Check method**

On the wired remote controller, central control remote controller and the interface P.C. board of the outdoor unit (I/F), a check display LCD (Remote controller) or 7-segment display (on the outdoor interface P.C. board) to display the operation is provided. Therefore the operation status can be known. Using this self-diagnosis function, a trouble or position with trouble of the air conditioner can be found as shown in the following table.

**Check code list**

The following list shows each check code. Find the check contents from the list according to part to be checked.

- In case of check from indoor remote controller: See "Wired remote controller display" in the list.
- In case of check from outdoor unit: See "Outdoor unit 7-segment display" in the list.
- In case of check from indoor unit with a wireless remote controller: See "Sensor block display of receiving unit" in the list.

○: Lighting, ◻: Flashing, ●: Goes off  
 ALT: Flashing is alternately when there are two flashing LED.  
 SIM: Simultaneous flashing when there are two flashing LED.

Check code			Wireless remote controller				Check code name	Judging device
Wired remote controller display	Outdoor unit 7-segment display		Sensor block display of receiving unit					
		Auxiliary code	Operation	Timer	Ready	Flash		
E01	—	—	◻	●	●		Communication trouble between indoor unit and remote controller (Detected at remote controller side)	Remote controller
E02	—	—	◻	●	●		Remote controller transmission trouble	Remote controller
E03	—	—	◻	●	●		Communication trouble between indoor unit and remote controller (Detected at indoor unit side)	Indoor unit
E04	—	—	●	●	◻		Communication circuit trouble between indoor / outdoor unit (Detected at indoor unit side)	Indoor unit
E06	E06	No. of indoor units in which sensor has been normally received	●	●	◻		Decrease of No. of indoor units	I/F
—	E07	—	●	●	◻		Communication circuit trouble between indoor / outdoor unit (Detected at outdoor unit side)	I/F
E08	E08	Duplicated indoor unit addresses	◻	●	●		Duplicated indoor unit addresses	Indoor unit + I/F
E09	—	—	◻	●	●		Duplicated master remote controllers	Remote controller
E10	—	—	◻	●	●		Communication trouble between indoor unit MCU	Indoor unit
E11	—	—	◻	●	●		Communication trouble between Application control kit and Indoor unit	Indoor unit Application control kit
E12	E12	01: Indoor/Outdoor units communication 02: Outdoor/Outdoor units communication	◻	●	●		Automatic address start trouble	I/F
E15	E15	—	●	●	◻		No indoor unit during automatic addressing	I/F
E16	E16	00: Capacity over 01 ~: No. of connected units	●	●	◻		Capacity over / No. of connected indoor units	I/F
E18	—	—	◻	●	●		Communication trouble between header and follower units Indoor unit	Indoor unit
E19	E19	00: Header is not detected 02: Two or more header units	●	●	◻		Outdoor header units quantity trouble	I/F
E20	E20	01: Outdoor unit of other line connected 02: Indoor unit of other line connected	●	●	◻		Other line connected during automatic address	I/F
E23	E23	—	●	●	◻		Sending trouble in communication between outdoor units Trouble in number of heat storage units (trouble with reception)	I/F
E25	E25	—	●	●	◻		Duplicated follower outdoor addresses	I/F
E26	E26	No. of outdoor units which received signal normally	●	●	◻		Decrease of No. of connected outdoor units	I/F
E28	E28	Detected outdoor unit number	●	●	◻		Follower outdoor unit trouble	I/F
E31	E31	*1 Inverter quantity information	●	●	◻		Inverter communication trouble	I/F
F01	—	—	◻	◻	●	ALT	Indoor unit TCJ sensor trouble	Indoor unit
F02	—	—	◻	◻	●	ALT	Indoor unit TC2 sensor trouble	Indoor unit
F03	—	—	◻	◻	●	ALT	Indoor unit TC1 sensor trouble	Indoor unit
F04	F04	—	◻	◻	○	ALT	TD1 sensor trouble	I/F
F05	F05	—	◻	◻	○	ALT	TD2 sensor trouble	I/F



Check code		Wireless remote controller				Check code name	Judging device		
Wired remote controller display	Outdoor unit 7-segment display		Sensor block display of receiving unit						
		Auxiliary code	Operation	Timer	Ready			Flash	
F06	F06	01: TE1 sensor 02: TE2 sensor 03: TE3 sensor	☐	☐	○	ALT	TE1,TE2 or TE3 sensor trouble	I/F	
F07	F07	01: TL1 sensor 02: TL2 sensor 03: TL3 sensor	☐	☐	○	ALT	TL1,TL2 or TL3 sensor trouble	I/F	
F08	F08	—	☐	☐	○	ALT	TO sensor trouble	I/F	
F09	F09	01: TG1 sensor 02: TG2 sensor 03: TG3 sensor	☐	☐	○	ALT	TG1,TG2 or TG3 sensor trouble	I/F	
F10	—	—	☐	☐	●	ALT	Indoor unit TA sensor trouble	Indoor unit	
F11	—	—	☐	☐	●	ALT	TF sensor trouble	Indoor unit	
F12	F12	01: TS1 sensor 03: TS3 sensor	☐	☐	○	ALT	TS1 or TS3 sensor trouble	I/F	
F13	F13	01: Comp. 1 side 02: Comp. 2 side 03: Comp. 3 side	1d: Comp. 1 side 2d: Comp. 2 side	☐	☐	○	ALT	TH sensor trouble	Compressor inverter
F15	F15	—	☐	☐	○	ALT	Outdoor unit temp. sensor miswiring (TE, TL)	I/F	
F16	F16	—	☐	☐	○	ALT	Outdoor unit pressure sensor miswiring (Pd, Ps)	I/F	
F22	F22	—	☐	☐	○	ALT	TD3 sensor trouble	I/F	
F23	F23	—	☐	☐	○	ALT	Ps sensor trouble	I/F	
F24	F24	—	☐	☐	○	ALT	Pd sensor trouble	I/F	
F29	—	—	☐	☐	●	SIM	Indoor unit other trouble	Indoor unit	
F30	F30	—	☐	☐	○	SIM	Occupancy sensor trouble	Indoor unit	
F31	F31	—	☐	☐	○	SIM	Indoor unit EEPROM trouble	I/F	
H01	H01	01: Comp. 1 side 02: Comp. 2 side 03: Comp. 3 side	1*: Comp. 1 side 2*: Comp. 2 side	●	☐	●		Compressor break down	Compressor inverter
H02	H02	01: Comp. 1 side 02: Comp. 2 side 03: Comp. 3 side	1*: Comp. 1 side 2*: Comp. 2 side	●	☐	●		Compressor trouble (lock)	Compressor inverter
H03	H03	01: Comp. 1 side 02: Comp. 2 side 03: Comp. 3 side	1*: Comp. 1 side 2*: Comp. 2 side	●	☐	●		Current detect circuit system trouble	Compressor inverter
H04	H04	—	●	☐	●		Comp. 1 case thermostat operation	I/F	
H05	H05	—	●	☐	●		TD1 sensor miswiring	I/F	
H06	H06	—	●	☐	●		Low pressure protective operation	I/F	
H07	H07	—	●	☐	●		Oil level down detective protection	I/F	
H08	H08	01: TK1 sensor trouble 02: TK2 sensor trouble 03: TK3 sensor trouble 04: TK4 sensor trouble 05: TK5 sensor trouble	●	☐	●		Oil level detective temp. sensor trouble	I/F	
H14	H14	—	●	☐	●		Comp. 2 case thermostat operation	I/F	
H15	H15	—	●	☐	●		TD2 sensor miswiring	I/F	
H16	H16	01: TK1 oil circuit system trouble 02: TK2 oil circuit system trouble 03: TK3 oil circuit system trouble 04: TK4 oil circuit system trouble 05: TK5 oil circuit system trouble	●	☐	●		Oil level detective circuit trouble	I/F	
H25	H25	—	●	☐	●		TD3 sensor miswiring	I/F	

Check code		Wireless remote controller				Check code name	Judging device	
Wired remote controller display	Outdoor unit 7-segment display		Sensor block display of receiving unit					
		Auxiliary code	Operation	Timer	Ready	Flash		
L02	L02	—	☐	●	☐	SIM	Model mismatch of indoor and outdoor unit	I/F
L03	—	—	☐	●	☐	SIM	Indoor unit centre unit duplicated	Indoor unit
L04	L04	—	☐	○	☐	SIM	Outdoor unit line address duplicated	I/F
L05	—	—	☐	●	☐	SIM	Duplicated indoor units with priority (Displayed in indoor unit with priority)	I/F
L06	L06	No. of indoor units with priority	☐	●	☐	SIM	Duplicated indoor units with priority (Displayed in unit other than indoor unit with priority)	I/F
L07	—	—	☐	●	☐	SIM	Group line in individual indoor unit	Indoor unit
L08	L08	—	☐	●	☐	SIM	Indoor unit group/Address unset	Indoor unit, I/F
L09	—	—	☐	●	☐	SIM	Indoor unit capacity unset	Indoor unit
L10	L10	—	☐	○	☐	SIM	Outdoor unit capacity unset	I/F
L17	L17	—	☐	○	☐	SIM	Outdoor unit type mismatch trouble	I/F
L18	L18	—	☐	○	☐	SIM	Flow selector unit trouble	I/F
L20	—	—	☐	○	☐	SIM	Duplicated central control addresses	Indoor unit
L28	L28	—	☐	○	☐	SIM	Too many outdoor units connected	I/F
L29	L29	*1 Inverter quantity information	☐	○	☐	SIM	No. of inverter trouble	I/F
L30	L30	Detected indoor unit address	☐	○	☐	SIM	Indoor unit outside interlock	Indoor unit
—	L31	—	—	—	—	—	Extended I/C trouble	I/F
P01	—	—	●	☐	☐	ALT	Indoor fan motor trouble	Indoor unit
P03	P03	—	☐	●	☐	ALT	Discharge temp. TD1 trouble	I/F
P04	P04	01: Comp. 1 side 02: Comp. 2 side 03: Comp. 3 side	☐	●	☐	ALT	High-pressure SW system operation	Compressor inverter
P05	P05	00: 01: Comp. 1 side 02: Comp. 2 side 03: Comp. 3 side	☐	●	☐	ALT	Phase missing detection/Power failure detection Inverter DC voltage trouble (comp.) Inverter DC voltage trouble (comp.) Inverter DC voltage trouble (comp.)	I/F
P07	P07	01: Comp. 1 side 02: Comp. 2 side 03: Comp. 3 side ----- 04: Heat sink	☐	●	☐	ALT	Heat sink overheat trouble ----- Heat sink dew condensation trouble	Compressor inverter, I/F
P10	P10	Detected indoor unit address	●	☐	☐	ALT	Indoor unit overflow trouble	Indoor unit
P11	P11	—	●	☐	☐	ALT	Outdoor heat exchanger freezing trouble	I/F
P12	—	—	●	☐	☐	ALT	Indoor unit fan motor trouble	Indoor unit
P13	P13	—	●	☐	☐	ALT	Outdoor liquid back detection trouble	I/F
P15	P15	01: TS condition 02: TD condition	☐	●	☐	ALT	Gas leak detection	I/F
P17	P17	—	☐	●	☐	ALT	Discharge temp. TD2 trouble	I/F
P19	P19	Detected outdoor unit number	☐	●	☐	ALT	4-way valve inverse trouble	I/F
P20	P20	—	☐	●	☐	ALT	High-pressure protective operation	I/F
P22	P22	#0: Element short circuit #E: Vdc voltage trouble #1: Position detection circuit trouble #2: Input current sensor trouble #3: Motor lock trouble #C: Sensor temperature trouble (No TH sensor) #4: Motor current trouble #D: Sensor short circuit/release trouble (No TH sensor) #5: Synchronization/step-out trouble *Put in Fan Inverter No. in [#] mark.	☐	●	☐	ALT	Outdoor unit fan inverter trouble	Fan inverter

Check code			Wireless remote controller				Check code name	Judging device
Wired remote controller display	Outdoor unit 7-segment display		Sensor block display of receiving unit					
		Auxiliary code	Operation	Timer	Ready	Flash		
P26	P26	01: Comp. 1 side 02: Comp. 2 side 03: Comp. 3 side	☐	●	☐	ALT	IPM short protection trouble	Compressor inverter
P29	P29	01: Comp. 1 side 02: Comp. 2 side 03: Comp. 3 side	☐	●	☐	ALT	Comp. position detective circuit system trouble	Compressor inverter
P31	—	—	☐	●	☐	ALT	Other indoor unit trouble (Group follower indoor unit trouble)	Indoor unit

**\*1 Inverter quantity information**

(Super Modular Multi System i series (SMMS-i))

No.	Comp. Inverter			Fan Inverter	Trouble
	1	2	3		
01	○				Comp. 1
02		○			Comp. 2
03	○	○			Comp. 1 + Comp. 2
04			○		Comp. 3
05	○		○		Comp. 1 + Comp. 3
06		○	○		Comp. 2 + Comp. 3
07	○	○	○		Comp. 1 + Comp. 2 + Comp. 3
08				○	Fan
09	○			○	Comp. 1 + Fan
0A		○		○	Comp. 2 + Fan
0B	○	○		○	Comp. 1 + Comp. 2 + Fan
0C			○	○	Comp. 3 + Fan
0D	○		○	○	Comp. 1 + Comp. 3 + Fan
0E		○	○	○	Comp. 2 + Comp. 3 + Fan
0F	○	○	○	○	All

○: Inverter trouble

**\*1 Inverter quantity information**

(Super Modular Multi System e and u series (SMMS-e, SMMS-u))

No.	Comp. Inverter		Fan Inverter		Trouble
	1	2	1	2	
01	○				Comp. 1
02		○			Comp. 2
03	○	○			Comp. 1 + Comp. 2
08			○		Fan1
09	○		○		Comp. 1 + Fan1
0A		○	○		Comp. 2 + Fan1
0B	○	○	○		Comp. 1 + Comp. 2 + Fan1
10				○	Fan2
11	○			○	Comp. 1 + Fan2
12		○		○	Comp. 2 + Fan2
13	○	○		○	Comp. 1 + Comp. 2 + Fan2
18			○	○	Fan1 + Fan2
19	○		○	○	Comp. 1 + Fan1 + Fan2
1A		○	○	○	Comp. 2 + Fan1 + Fan2
1B	○	○	○	○	All

○: Inverter trouble

• For details about check codes determined with an Interface P.C board or an Inverter P.C board, refer to the Installation Manual of the outdoor unit.

**Trouble detected by central control device**

Check code			Wireless remote controller				Check code name	Judging device
Central control device indication	Outdoor unit 7-segment display		Sensor block display of receiving unit					
		Auxiliary code	Operation	Timer	Ready	Flash		
C05	—	—	—	—	—	—	Sending trouble in central control device	Central control device
C06	—	—	—	—	—	—	Receiving trouble in central control device	Central control device
C12	—	—	—	—	—	—	Batch alarm of general-purpose equipment control interface	General-purpose equipment I/F
P30 (L20)	Differs according to trouble contents of unit with occurrence of alarm						Group control follower unit trouble	Central control device
	—	—	(L20 is displayed.)				<ul style="list-style-type: none"> <li>Duplication addresses of indoor units in central control device</li> <li>With the combination of air conditioning system, the indoor unit may detect the check code of L20</li> </ul>	

# 12 Specifications

Model	Sound pressure level (dBA)		Weight (kg) Main unit (Ceiling panel)
	Cooling	Heating	
MMU-UP0051MH-E	*	*	15 (2.5)
MMU-UP0071MH-E	*	*	15 (2.5)
MMU-UP0091MH-E	*	*	15 (2.5)
MMU-UP0121MH-E	*	*	15 (2.5)
MMU-UP0151MH-E	*	*	15 (2.5)
MMU-UP0181MH-E	*	*	15 (2.5)

\* Under 70 dBA

## Declaration of Conformity

Manufacturer: TOSHIBA CARRIER CORPORATION  
336 Tadehara, Fuji-shi, Shizuoka-ken 416-8521 JAPAN

TCF holder: TOSHIBA CARRIER EUROPE S.A.S  
Route de Thil  
01120 Montluel FRANCE

Hereby declares that the machinery described below:

Generic Denomination: Air Conditioner

Model / type: MMU-UP0051MH-E, MMU-UP0071MH-E, MMU-UP0091MH-E,  
MMU-UP0121MH-E, MMU-UP0151MH-E, MMU-UP0181MH-E

Commercial name: Super Modular Multi System Air Conditioner  
Super Heat Recovery Multi System Air Conditioner  
Mini-Super Modular Multi System Air Conditioner (MiNi-SMMS series)

Complies with the provisions of the "Machinery" Directive (Directive 2006/42/EC) and the regulations transposing into national law

### NOTE

This declaration becomes invalid if technical or operational modifications are introduced without the manufacturer's consent.

## WARNINGS ON REFRIGERANT LEAKAGE

### Check of Concentration Limit

The room in which the air conditioner is to be installed requires a design that in the event of refrigerant gas leaking out, its concentration will not exceed a set limit.

The refrigerant R410A which is used in the air conditioner is safe, without the toxicity or combustibility of ammonia, and is not restricted by laws to be imposed which protect the ozone layer. However, since it contains more than air, it poses the risk of suffocation if its concentration should rise excessively. Suffocation from leakage of R410A is almost non-existent. With the recent increase in the number of high concentration buildings, however, the installation of multi air conditioner systems is on the increase because of the need for effective use of floor space, individual control, energy conservation by curtailing heat and carrying power etc.

Most importantly, the multi air conditioner system is able to replenish a large amount of refrigerant compared with conventional individual air conditioners. If a single unit of the multi conditioner system is to be installed in a small room, select a suitable model and installation procedure so that if the refrigerant accidentally leaks out, its concentration does not reach the limit (and in the event of an emergency, measures can be made before injury can occur).

In a room where the concentration may exceed the limit, create an opening with adjacent rooms, or install mechanical ventilation combined with a gas leak detection device.

The concentration is as given below.

$$\frac{\text{Total amount of refrigerant (kg)}}{\text{Min. volume of the indoor unit installed room (m}^3\text{)}} \leq \text{Concentration limit (kg/m}^3\text{)}$$

Refrigerant Concentration Limit shall be in accordance with local regulations.

### ▼ NOTE 1

If there are 2 or more refrigerating systems in a single refrigerating device, the amounts of refrigerant should be as charged in each independent device.

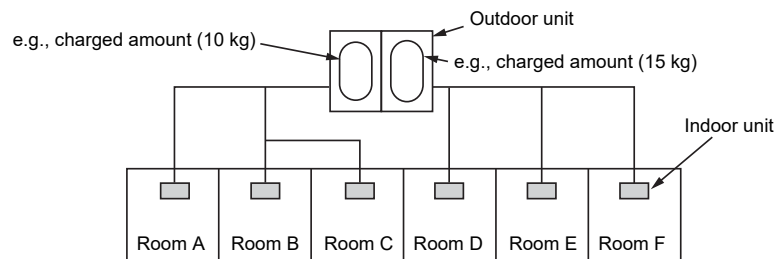

For the amount of charge in this example:

The possible amount of leaked refrigerant gas in rooms A, B and C is 10 kg.

The possible amount of leaked refrigerant gas in rooms D, E and F is 15 kg.

## ■ Important

### ▼ NOTE 2

The standards for minimum room volume are as follows.

- 1) No partition (shaded portion)

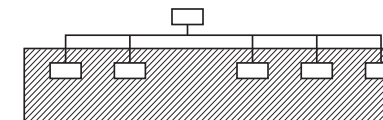

- 2) When there is an effective opening with the adjacent room for ventilation of leaking refrigerant gas (opening without a door, or an opening 0.15% or larger than the respective floor spaces at the top or bottom of the door).

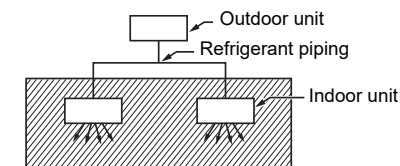

- 3) If an indoor unit is installed in each partitioned room and the refrigerant piping is interconnected, the smallest room of course becomes the object. But when a mechanical ventilation is installed interlocked with a gas leakage detector in the smallest room where the density limit is exceeded, the volume of the next smallest room becomes the object.

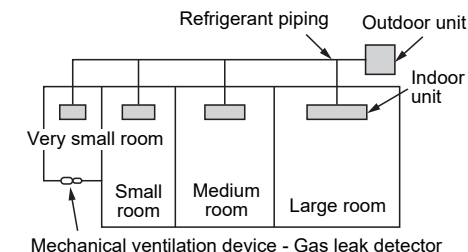

## Confirmation of indoor unit setup

Prior to delivery to the customer, check the address and setup of the indoor unit, which has been installed in this time and fill the check sheet (Table below). Data of four units can be entered in this check sheet. Copy this sheet according to the No. of the indoor units. If the installed system is a group control system, use this sheet by entering each line system into each installation manual attached to the other indoor units.

### REQUIREMENT

This check sheet is required for maintenance after installation. Fill this sheet and then pass this Installation Manual to the customers.

### Indoor unit setup check sheet

Indoor unit		Indoor unit		Indoor unit		Indoor unit		
Room name	Room name	Room name	Room name	Room name	Room name	Room name	Room name	
Model	Model	Model	Model	Model	Model	Model	Model	
Check indoor unit address. (For check method, refer to Service Manual of outdoor unit.) *In case of a single system, it is unnecessary to enter the indoor address. (CODE NO.: Line [12], Indoor [13], Group [14], Central control [03])								
Line	Indoor	Group	Line	Indoor	Group	Line	Indoor	Group
Central control address		Central control address		Central control address		Central control address		
Various setup		Various setup		Various setup		Various setup		
Have you changed high ceiling setup? If not, fill check mark [x] in [NO CHANGE], and fill check mark [x] in [ITEM] if changed, respectively. (For check method, refer to APPLCABLE CONTROLS in this manual.) * In case of replacement of jumper blocks on indoor microcomputer P.C. board, setup is automatically changed.								
High ceiling setup (CODE NO. [5d])		High ceiling setup (CODE NO. [5d])		High ceiling setup (CODE NO. [5d])		High ceiling setup (CODE NO. [5d])		
<input type="checkbox"/> NO CHANGE	<input type="checkbox"/> NO CHANGE	<input type="checkbox"/> NO CHANGE	<input type="checkbox"/> NO CHANGE	<input type="checkbox"/> NO CHANGE	<input type="checkbox"/> NO CHANGE	<input type="checkbox"/> NO CHANGE	<input type="checkbox"/> NO CHANGE	
<input type="checkbox"/> STANDARD	<input type="checkbox"/> STANDARD	<input type="checkbox"/> STANDARD	<input type="checkbox"/> STANDARD	<input type="checkbox"/> STANDARD	<input type="checkbox"/> STANDARD	<input type="checkbox"/> STANDARD	<input type="checkbox"/> STANDARD	
<input type="checkbox"/> HIGH CEILING 1	<input type="checkbox"/> HIGH CEILING 1	<input type="checkbox"/> HIGH CEILING 1	<input type="checkbox"/> HIGH CEILING 1	<input type="checkbox"/> HIGH CEILING 1	<input type="checkbox"/> HIGH CEILING 1	<input type="checkbox"/> HIGH CEILING 1	<input type="checkbox"/> HIGH CEILING 1	
<input type="checkbox"/> HIGH CEILING 3	<input type="checkbox"/> HIGH CEILING 3	<input type="checkbox"/> HIGH CEILING 3	<input type="checkbox"/> HIGH CEILING 3	<input type="checkbox"/> HIGH CEILING 3	<input type="checkbox"/> HIGH CEILING 3	<input type="checkbox"/> HIGH CEILING 3	<input type="checkbox"/> HIGH CEILING 3	
Have you changed lighting time of filter sign? If not, fill check mark [x] in [NO CHANGE], and fill check mark [x] in [ITEM] if changed, respectively. (For check method, refer to APPLCABLE CONTROLS in this manual.)								
Filter sign lighting time (CODE NO. [01])		Filter sign lighting time (CODE NO. [01])		Filter sign lighting time (CODE NO. [01])		Filter sign lighting time (CODE NO. [01])		
<input type="checkbox"/> NO CHANGE	<input type="checkbox"/> NO CHANGE	<input type="checkbox"/> NO CHANGE	<input type="checkbox"/> NO CHANGE	<input type="checkbox"/> NO CHANGE	<input type="checkbox"/> NO CHANGE	<input type="checkbox"/> NO CHANGE	<input type="checkbox"/> NO CHANGE	
<input type="checkbox"/> NONE	<input type="checkbox"/> NONE	<input type="checkbox"/> NONE	<input type="checkbox"/> NONE	<input type="checkbox"/> NONE	<input type="checkbox"/> NONE	<input type="checkbox"/> NONE	<input type="checkbox"/> NONE	
<input type="checkbox"/> 150 H	<input type="checkbox"/> 150 H	<input type="checkbox"/> 150 H	<input type="checkbox"/> 150 H	<input type="checkbox"/> 150 H	<input type="checkbox"/> 150 H	<input type="checkbox"/> 150 H	<input type="checkbox"/> 150 H	
<input type="checkbox"/> 2500 H	<input type="checkbox"/> 2500 H	<input type="checkbox"/> 2500 H	<input type="checkbox"/> 2500 H	<input type="checkbox"/> 2500 H	<input type="checkbox"/> 2500 H	<input type="checkbox"/> 2500 H	<input type="checkbox"/> 2500 H	
<input type="checkbox"/> 5000 H	<input type="checkbox"/> 5000 H	<input type="checkbox"/> 5000 H	<input type="checkbox"/> 5000 H	<input type="checkbox"/> 5000 H	<input type="checkbox"/> 5000 H	<input type="checkbox"/> 5000 H	<input type="checkbox"/> 5000 H	
<input type="checkbox"/> 10000 H	<input type="checkbox"/> 10000 H	<input type="checkbox"/> 10000 H	<input type="checkbox"/> 10000 H	<input type="checkbox"/> 10000 H	<input type="checkbox"/> 10000 H	<input type="checkbox"/> 10000 H	<input type="checkbox"/> 10000 H	
Have you changed detected temp. shift value? If not, fill check mark [x] in [NO CHANGE], and fill check mark [x] in [ITEM] if changed, respectively. (For check method, refer to APPLCABLE CONTROLS in this manual.)								
Detected temp. shift value setup (CODE NO. [06])		Detected temp. shift value setup (CODE NO. [06])		Detected temp. shift value setup (CODE NO. [06])		Detected temp. shift value setup (CODE NO. [06])		
<input type="checkbox"/> NO CHANGE	<input type="checkbox"/> NO CHANGE	<input type="checkbox"/> NO CHANGE	<input type="checkbox"/> NO CHANGE	<input type="checkbox"/> NO CHANGE	<input type="checkbox"/> NO CHANGE	<input type="checkbox"/> NO CHANGE	<input type="checkbox"/> NO CHANGE	
<input type="checkbox"/> NO SHIFT	<input type="checkbox"/> NO SHIFT	<input type="checkbox"/> NO SHIFT	<input type="checkbox"/> NO SHIFT	<input type="checkbox"/> NO SHIFT	<input type="checkbox"/> NO SHIFT	<input type="checkbox"/> NO SHIFT	<input type="checkbox"/> NO SHIFT	
<input type="checkbox"/> +1°C	<input type="checkbox"/> +1°C	<input type="checkbox"/> +1°C	<input type="checkbox"/> +1°C	<input type="checkbox"/> +1°C	<input type="checkbox"/> +1°C	<input type="checkbox"/> +1°C	<input type="checkbox"/> +1°C	
<input type="checkbox"/> +2°C	<input type="checkbox"/> +2°C	<input type="checkbox"/> +2°C	<input type="checkbox"/> +2°C	<input type="checkbox"/> +2°C	<input type="checkbox"/> +2°C	<input type="checkbox"/> +2°C	<input type="checkbox"/> +2°C	
<input type="checkbox"/> +3°C	<input type="checkbox"/> +3°C	<input type="checkbox"/> +3°C	<input type="checkbox"/> +3°C	<input type="checkbox"/> +3°C	<input type="checkbox"/> +3°C	<input type="checkbox"/> +3°C	<input type="checkbox"/> +3°C	
<input type="checkbox"/> +4°C	<input type="checkbox"/> +4°C	<input type="checkbox"/> +4°C	<input type="checkbox"/> +4°C	<input type="checkbox"/> +4°C	<input type="checkbox"/> +4°C	<input type="checkbox"/> +4°C	<input type="checkbox"/> +4°C	
<input type="checkbox"/> +5°C	<input type="checkbox"/> +5°C	<input type="checkbox"/> +5°C	<input type="checkbox"/> +5°C	<input type="checkbox"/> +5°C	<input type="checkbox"/> +5°C	<input type="checkbox"/> +5°C	<input type="checkbox"/> +5°C	
<input type="checkbox"/> +6°C	<input type="checkbox"/> +6°C	<input type="checkbox"/> +6°C	<input type="checkbox"/> +6°C	<input type="checkbox"/> +6°C	<input type="checkbox"/> +6°C	<input type="checkbox"/> +6°C	<input type="checkbox"/> +6°C	
Remote controller sensor (CODE NO. [32])		Remote controller sensor (CODE NO. [32])		Remote controller sensor (CODE NO. [32])		Remote controller sensor (CODE NO. [32])		
<input type="checkbox"/> NO CHANGE	<input type="checkbox"/> NO CHANGE	<input type="checkbox"/> NO CHANGE	<input type="checkbox"/> NO CHANGE	<input type="checkbox"/> NO CHANGE	<input type="checkbox"/> NO CHANGE	<input type="checkbox"/> NO CHANGE	<input type="checkbox"/> NO CHANGE	
<input type="checkbox"/> NOT IN USE	<input type="checkbox"/> NOT IN USE	<input type="checkbox"/> NOT IN USE	<input type="checkbox"/> NOT IN USE	<input type="checkbox"/> NOT IN USE	<input type="checkbox"/> NOT IN USE	<input type="checkbox"/> NOT IN USE	<input type="checkbox"/> NOT IN USE	
<input type="checkbox"/> IN USE	<input type="checkbox"/> IN USE	<input type="checkbox"/> IN USE	<input type="checkbox"/> IN USE	<input type="checkbox"/> IN USE	<input type="checkbox"/> IN USE	<input type="checkbox"/> IN USE	<input type="checkbox"/> IN USE	
Incorporation of parts sold separately		Incorporation of parts sold separately		Incorporation of parts sold separately		Incorporation of parts sold separately		
Have you incorporated the following parts sold separately? If incorporated, fill check mark [x] in each [ITEM]. (When incorporating, the setup change is necessary in some cases. For setup change method, refer to Installation Manual attached to each part sold separately.)								
<input type="checkbox"/> Others ( )	<input type="checkbox"/> Others ( )	<input type="checkbox"/> Others ( )	<input type="checkbox"/> Others ( )	<input type="checkbox"/> Others ( )	<input type="checkbox"/> Others ( )	<input type="checkbox"/> Others ( )	<input type="checkbox"/> Others ( )	

# **Toshiba Carrier Corporation**

**336 TADEHARA, FUJI-SHI, SHIZUOKA-KEN 416-8521 JAPAN**

**EB99840501**