

Air conditioner

User manual

Wired remote controller MWR-WG00JN

- Thank you for purchasing this Samsung Product.
- Before operating this unit, please read this user manual carefully and retain it for future reference.



SAMSUNG

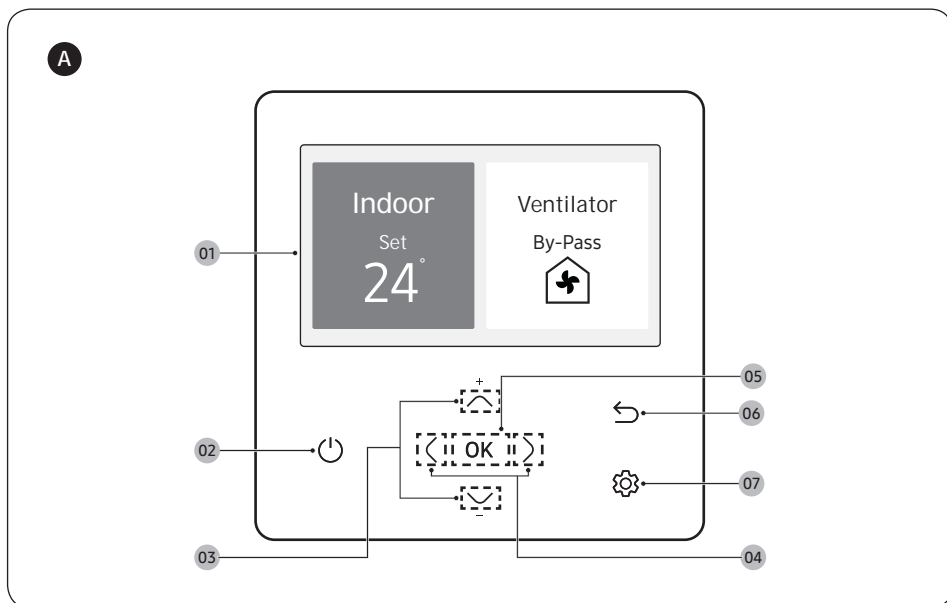

A Remote Controller Overview

EN

- | | |
|---|---|
| <p>01 Operation status display</p> <ul style="list-style-type: none"> - Displays the operation/function settings and statuses. <p>02 Operation On/Off button (LED display)</p> <ul style="list-style-type: none"> - Turns the air conditioner/ventilator power On/Off <p>03 Up/Down button</p> <ul style="list-style-type: none"> - Moves between items vertically or changes the set temperature. <p>04 Left/Right button</p> <ul style="list-style-type: none"> - Moves between items horizontally or changes the item value. <p>05 OK button</p> <ul style="list-style-type: none"> - Saves your new settings. <p>06 Save & Return button</p> <ul style="list-style-type: none"> - Saves your new settings and returns to the previous step. | <p>07 Option button</p> <ul style="list-style-type: none"> - Selects the detailed setting function. <p>NOTE</p> <ul style="list-style-type: none"> • The operation mode display on the remote controller changes depending on the selected language. • Some functions may not be available, depending on the indoor unit specifications. • You can see the operation status on the LED display. <ul style="list-style-type: none"> - ON: Operating, Blinking: An error occurred, OFF: Turns off |
|---|---|

A Descripción general del control remoto

ES

- | | |
|--|---|
| <p>01 Pantalla de estado de funcionamiento</p> <ul style="list-style-type: none"> - Muestra los ajustes y estados del funcionamiento o función. <p>02 Botón de Funcionamiento On/Off (pantalla LED)</p> <ul style="list-style-type: none"> - Apaga o enciende la alimentación del aire acondicionado o ventilador <p>03 Botón Arriba/Abajo</p> <ul style="list-style-type: none"> - Se mueve verticalmente entre los elementos o cambia la temperatura establecida. <p>04 Botón Izquierda/Derecha</p> <ul style="list-style-type: none"> - Se mueven horizontalmente entre los elementos o cambia el valor del elemento. <p>05 Botón OK</p> <ul style="list-style-type: none"> - Guarda sus ajustes nuevos. <p>06 Botón Guardar y Volver</p> <ul style="list-style-type: none"> - Guarda sus nuevos ajustes y vuelve al paso anterior. | <p>07 Botón Opción</p> <ul style="list-style-type: none"> - Selecciona la función de ajuste detallado. <p>NOTE</p> <ul style="list-style-type: none"> • La pantalla de modo de funcionamiento del control remoto cambia según el idioma seleccionado. • Es posible que algunas funciones no estén disponibles, según las especificaciones de la unidad interna. • Puede ver el estado de funcionamiento en la pantalla LED. <ul style="list-style-type: none"> - ENCENDIDO Funcionando, Parpadeando: Se ha producido un error, OFF: Apaga |
|--|---|

A Aperçu de la télécommande

FR

- | | |
|---|--|
| <p>01 Affichage de l'état de fonctionnement</p> <ul style="list-style-type: none"> - Affiche les réglages et les états du fonctionnement/de la fonction. <p>02 Bouton de mise en marche/arrêt (affichage LED)</p> <ul style="list-style-type: none"> - Met le climatiseur/ventilateur en marche/arrêt <p>03 Bouton haut/bas</p> <ul style="list-style-type: none"> - Parcourt les éléments verticalement ou modifie la température configurée. <p>04 Bouton gauche/droite</p> <ul style="list-style-type: none"> - Parcourt les éléments horizontalement ou modifie la valeur de l'élément. <p>05 Bouton OK</p> <ul style="list-style-type: none"> - Enregistre vos nouveaux réglages. <p>06 Bouton d'enregistrement et de retour</p> <ul style="list-style-type: none"> - Enregistre vos nouveaux réglages et retourne à l'étape précédente. | <p>07 Bouton Option</p> <ul style="list-style-type: none"> - Sélectionne la fonction de réglage avancé. <p>REMARQUE</p> <ul style="list-style-type: none"> • L'affichage du mode de fonctionnement sur la télécommande change en fonction de la langue sélectionnée. • La disponibilité de certaines fonctions dépend des spécifications de l'unité intérieure. • Vous pouvez voir l'état de fonctionnement sur l'affichage LED. <ul style="list-style-type: none"> - ON : En fonctionnement, Clignotant : Une erreur s'est produite, OFF : S'éteint |
|---|--|

A Descrição geral do controlo remoto

PT

- | | |
|---|---|
| <p>01 Visor do estado de funcionamento</p> <ul style="list-style-type: none"> - Exibe as definições e os estados de funcionamento/função. <p>02 Botão Ligar/Desligar funcionamento (visor LED)</p> <ul style="list-style-type: none"> - Liga/Desliga o aparelho de ar condicionado/ventilador <p>03 Botão Para cima/Para baixo</p> <ul style="list-style-type: none"> - Navega verticalmente entre itens ou altera a temperatura definida. <p>04 Botão Esquerda/Direita</p> <ul style="list-style-type: none"> - Navega horizontalmente entre itens ou altera o valor de um item. <p>05 Botão OK</p> <ul style="list-style-type: none"> - Guarda as suas novas definições. <p>06 Botão Guardar & Voltar</p> <ul style="list-style-type: none"> - Guarda as suas novas definições e volta ao passo anterior. | <p>07 Botão Opção</p> <ul style="list-style-type: none"> - Selecciona a função de definições detalhadas. <p>NOTA</p> <ul style="list-style-type: none"> • O visor do modo de funcionamento no controlo remoto altera-se em função do idioma selecionado. • Algumas funções poderão não estar disponíveis, dependendo das especificações da unidade interior. • Pode ver o estado de funcionamento no visor LED. <ul style="list-style-type: none"> - LIGADO: em funcionamento, Intermitente: ocorreu um erro, OFF: desliga-se |
|---|---|

A Übersicht über die Fernbedienung

DE

- | | |
|--|--|
| <p>01 Betriebsstatusanzeige</p> <ul style="list-style-type: none"> - Zeigt die Betriebs-/Funktionseinstellungen und Status an. <p>02 Betriebsstaste (LED-Display)</p> <ul style="list-style-type: none"> - Schaltet die Stromversorgung der Klimaanlage/des Ventilators ein/aus. <p>03 Auf-/Ab-Taste</p> <ul style="list-style-type: none"> - Blättert zwischen den Elementen nach oben oder unten oder ändert die Solltemperatur. <p>04 Linke/Rechte Taste</p> <ul style="list-style-type: none"> - Blättert zwischen den Elementen nach links oder rechts oder ändert den Elementwert. <p>05 Taste OK</p> <ul style="list-style-type: none"> - Speichert die neuen Einstellungen. <p>06 Taste zum Speichern und Zurückkehren</p> <ul style="list-style-type: none"> - Speichert die neuen Einstellungen und kehrt zum vorherigen Schritt zurück. | <p>07 Optiontaste</p> <ul style="list-style-type: none"> - Wählt die detaillierte Einstellungsfunktion. <p>HINWEIS</p> <ul style="list-style-type: none"> • Die Betriebsmodusanzeige auf der Fernbedienung ändert sich je nach der ausgewählten Sprache. • Manche Funktionen sind je nach den Spezifikationen des Innengeräts nicht verfügbar. • Der Betriebsstatus wird auf der LED-Anzeige angezeigt. <ul style="list-style-type: none"> - EIN: In Betrieb, Blinkt: Fehler, AUS: Ausschalten |
|--|--|

A Overzicht afstandsbediening

NL

- | | |
|---|---|
| <p>01 Weergave werkingstatus</p> <ul style="list-style-type: none"> - Toont de werkins-/functie-instellingen en statussen. <p>02 Knop Bediening Aan/Uit (LED-scherm)</p> <ul style="list-style-type: none"> - Schakelt de airconditioner/ventilator in/uit <p>03 Omhoog/Omlaag knop</p> <ul style="list-style-type: none"> - Beweegt verticaal tussen items of wijzigt de ingestelde temperatuur. <p>04 Knop Links/Rechts</p> <ul style="list-style-type: none"> - Beweegt horizontaal tussen items of wijzigt de itemwaarde. <p>05 Knop OK</p> <ul style="list-style-type: none"> - Bewaart uw nieuwe instellingen. <p>06 Knop Opslaan en Terugkeren</p> <ul style="list-style-type: none"> - Bewaart uw nieuwe instellingen en keert terug naar de vorige stap. | <p>07 Knop Optie</p> <ul style="list-style-type: none"> - Selecteert de functie gedetailleerde instelling. <p>OPMERKING</p> <ul style="list-style-type: none"> • De weergave van de werkingstatus op de afstandsbediening verandert afhankelijk van de geselecteerde taal. • Sommige functies zijn niet beschikbaar, afhankelijk van de specificaties van de binnenunit. • U kunt de werkingstatus zien op het LED-scherm. <ul style="list-style-type: none"> - AAN: In werking, Knippert: Er is een fout opgetreden, UIT: Schakelt uit |
|---|---|

B

Air conditioner

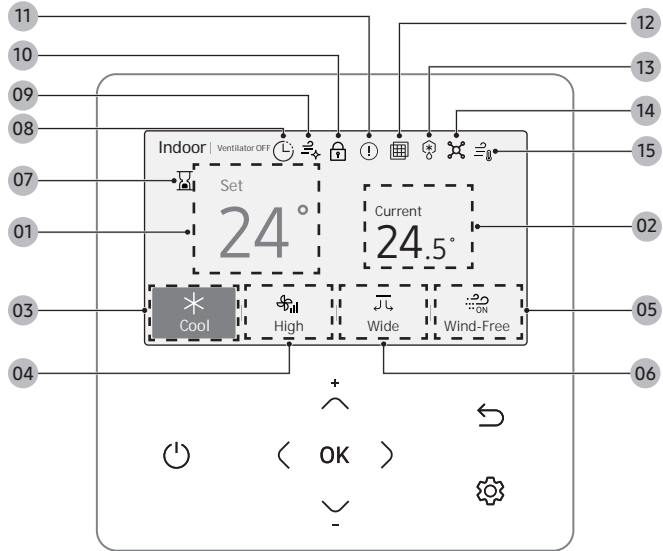

Ventilator

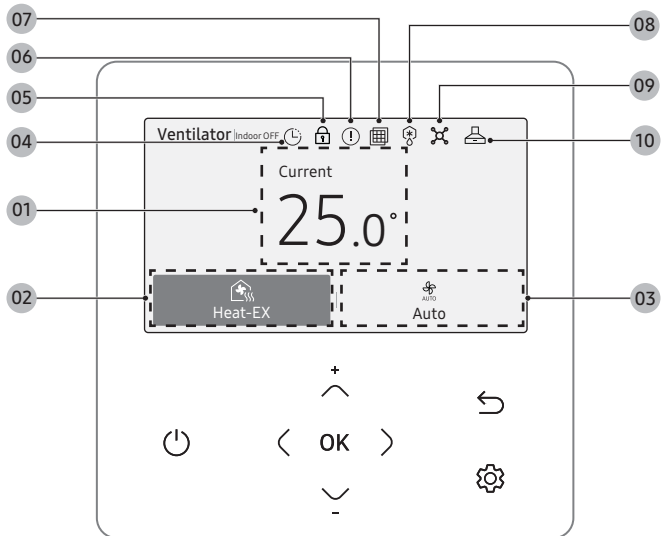

C

Air conditioner

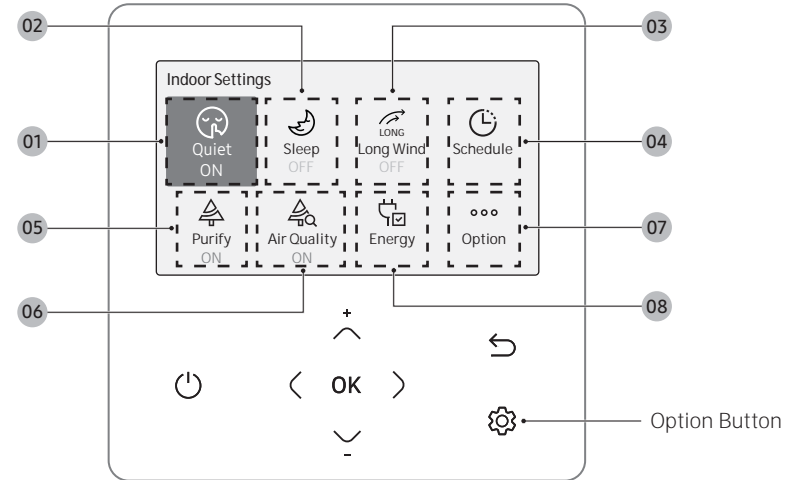

Ventilator

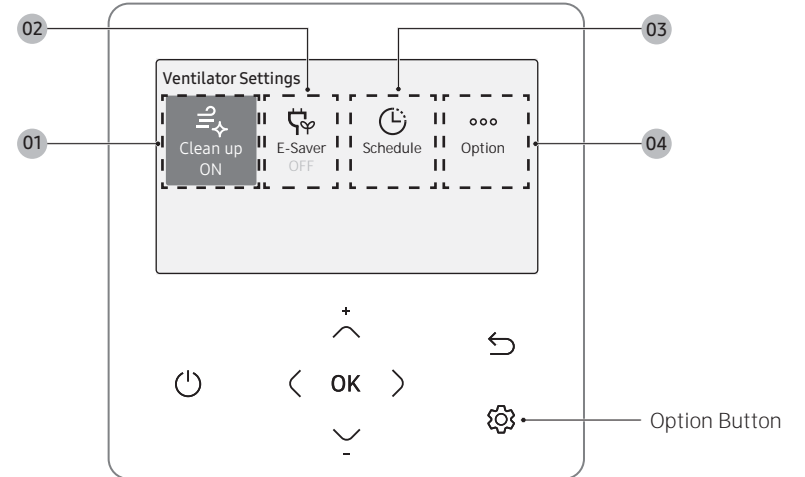

Air conditioner

- 01 Set temperature display
- 02 Current temperature display
- 03 Operation mode display
 - Displays any of Auto, Cool, Dry, Fan, and Heat.
- 04 Fan speed display
 - Displays any of Auto, Turbo, High, Medium, and Low.
- 05 Wind-Free display
- 06 Air flow direction display
 - Displays any of Fix, Spot, Mid, Wide, Swing, and Individual.
- 07 Activation Time Setting display
 - When Energy Saving Timer is activated.
 - When Override time is activated.
- 08 Schedule indicator
 - When a General Schedule is set.
 - When a Setback Schedule is set.
- 09 Clean indicator
- 10 Lock indicator
- 11 Check indicator
- 12 Filter reset indicator
- 13 Defrost indicator
- 14 Central Control indicator
- 15 Discharge temperature indicator

Ventilator

- 01 Current temperature display
 - 02 Operation mode display
 - Displays any of Heat-EX, Auto, By-Pass, Quiet, and Away.
 - 03 Fan speed display
 - Displays any of Auto, Turbo, High, and Low.
 - 04 Schedule indicator
 - When a General Schedule is set.
 - When a Setback Schedule is set.
 - 05 Lock indicator
 - 06 Check indicator
 - 07 Filter reset indicator
 - 08 Defrost indicator
 - 09 Central Control indicator
 - 10 Range hood (Exhaust hood) indicator
- NOTE**
- Unavailable functions are marked inactive and they cannot be set.
 - The locations of icons may differ depending on the function.
 - When you do not press any button for 7 seconds, the function of the position is automatically selected.

C Settings Screen Overview

Press the  button to enter the Settings screen and then select the desired function or option.

Air conditioner

- 01 Quiet display
 - Displays the Quiet function.
- 02 Sleep display
 - Displays the Sleep function.
- 03 Long Wind display
 - Displays the Long Wind function.
- 04 Schedule display
 - Displays any of Timer, Weekly schedule, Yearly schedule, and Holiday.
- 05 Purify display
 - Displays the Purify function.
- 06 Air Quality display
 - Displays the Air Quality.
- 07 Option display
 - Displays the Option.
- 08 Energy display
 - Displays any of Energy Usage, Energy Saving, and Energy Settings.

Ventilator

- 01 Clean up display
 - Displays the Clean up function.
 - 02 E-Saver display
 - Displays the E-Saver function.
 - 03 Schedule display
 - Displays any of Timer, Weekly schedule, Yearly schedule, and Holiday.
 - 04 Option display
 - Displays the Option.
- NOTE**
- Unavailable functions are marked inactive and they cannot be set.
 - In the menu with the > in the Option menu, you can select a menu with the > button.
 - When you do not press any button for 180 seconds with the option active, the settings are not saved and the Home screen appears.

Aire acondicionado

- 01 Pantalla temperatura establecida
- 02 Pantalla temperatura actual
- 03 Pantalla modo de funcionamiento
 - Muestra cualquiera de los valores Auto, Frio, Seco, Vent o Calor.
- 04 Pantalla de velocidad del ventilador
 - Muestra cualquiera de los valores Auto, Turbo, Alto, Medio o Bajo.
- 05 Pantalla de Wind-Free
- 06 Pantalla de dirección del flujo de aire
 - Muestra cualquiera de los valores Fijo, Concentrado, Medio, Amplio, Swing o Individual.
- 07 Visualización de Ajustes de Activación
 - Cuando se activa Temporizador de Ahorro Energético.
 - Cuando se activa el tiempo de Anular.
- 08 Indicador de Programa
 - Cuando se establece una Horario.
 - Cuando se establece una Retrasar Horario.
- 09 Indicador de Limpiar
- 10 Indicador de Bloque.
- 11 Indicador de comprobación
- 12 Indicador de Reinicio de filtro
- 13 Indicador de Desescarche
- 14 Indicador de Control central
- 15 Indicador de Tª de descarga

Ventilación

- 01 Pantalla temperatura actual
- 02 Pantalla modo de funcionamiento
 - Muestra cualquiera de los valores Recup., Auto, By-Pass, Silencioso o Ausente.
- 03 Pantalla de velocidad del ventilador
 - Muestra cualquiera de los valores Auto, Turbo, Alto o Bajo.
- 04 Indicador de Programa
 - Cuando se establece una Horario.
 - Cuando se establece una Retrasar Horario.
- 05 Indicador de Bloque.
- 06 Indicador de comprobación
- 07 Indicador de Reinicio de filtro
- 08 Indicador de Desescarche
- 09 Indicador de Control central
- 10 Indicador de Extractor (Campana extractora)

NOTA

- Las funciones no disponibles se marcan como inactivas y no se pueden establecer.
- La ubicación de los iconos puede diferir según cada función.
- Si no presiona ningún botón durante siete segundos, la función de la posición se selecciona automáticamente.

C Descripción general de la pantalla de ajustes

Pulse el botón  para entrar en la pantalla de ajustes y, a continuación, seleccione la función u opción deseada.

Aire acondicionado

- 01 Pantalla Silen.
 - Muestra la función Silen.
- 02 Pantalla Sleep
 - Muestra la función Sleep.
- 03 Pantalla Long Wind
 - Muestra la función Long Wind.
- 04 Pantalla Programa
 - Muestra cualquiera de los siguientes valores: Temporizador, Programa semanal, Programa anual o Vacaciones.
- 05 Pantalla Lmp.
 - Muestra la función Lmp.
- 06 Pantalla Calidad Aire
 - Muestra la Calidad Aire.
- 07 Pantalla Opción
 - Muestra la Opción.
- 08 Pantalla Energía
 - Muestra cualquiera de los siguientes valores: Consumo de energía, Eco o Ajustes de energía.

Ventilación

- 01 Pantalla Lmp.
 - Muestra la función Lmp.
- 02 Pantalla Eco
 - Muestra la función Eco.
- 03 Pantalla Programa
 - Muestra cualquiera de los siguientes valores: Temporizador, Programa semanal, Programa anual o Vacaciones.
- 04 Pantalla Opción
 - Muestra la Opción.

NOTA

- Las funciones no disponibles se marcan como inactivas y no se pueden establecer.
- En el menú con el signo > dentro del menú Opción, podrá seleccionar un menú con el botón >.
- Si no pulsa ningún botón durante 180 segundos con la opción activa, los ajustes no se guardan y aparece la pantalla de inicio.

Climatiseur

- 01 Affichage de la température configurée
- 02 Affichage de la température actuelle
- 03 Affichage du mode de fonctionnement
 - Affiche n'importe laquelle de ces options : Auto, Froid, Sec, Ventil, et chaud.
- 04 Affichage de la vitesse du ventilateur
 - Affiche n'importe laquelle de ces options : Auto, Turbo, Grande, Moyenne, et Petite.
- 05 Affichage Wind-Free™
- 06 Affichage de la direction du flux d'air
 - Affiche n'importe laquelle de ces options : Fixe, Fixe, Moyen, Large, Balayage, et Individuelle.
- 07 Affichage de Réglage Heure
 - Lorsque Timer mode économie d'énergie est activé.
 - Lorsque l'heure de Passer est activée.
- 08 Indicateur de Prog.
 - Lorsqu'un Programmation est configuré.
 - Lorsqu'un Retour programmation est configuré.
- 09 Voyant de Nettoyage
- 10 Voyant de Verrouillage
- 11 Voyant de vérification
- 12 Voyant de Réinitialisation du filtre
- 13 Voyant de Dégivrage
- 14 Voyant de Commande centrale
- 15 Voyant de Température de sortie

Ventilateur

- 01 Affichage de la température actuelle
 - 02 Affichage du mode de fonctionnement
 - Affiche n'importe laquelle de ces options : Récup., Auto, Dériv., Silence, et Absence.
 - 03 Affichage de la vitesse du ventilateur
 - Affiche n'importe laquelle de ces options : Auto, Turbo, Grande, et Petite.
 - 04 Indicateur de Prog.
 - Lorsqu'un Programmation est configuré.
 - Lorsqu'un Retour programmation est configuré.
 - 05 Voyant de Verrouillage
 - 06 Voyant de vérification
 - 07 Voyant de Réinitialisation du filtre
 - 08 Voyant de Dégivrage
 - 09 Voyant de Commande centrale
 - 10 Voyant de Hotte (hotte d'évacuation)
- REMARQUE**
- Les fonctions indisponibles apparaissent inactives et ne peuvent être configurées.
 - L'emplacement des icônes peut différer selon la fonction.
 - Lorsque vous n'appuyez sur aucun bouton pendant 7 secondes, la fonction de la position est sélectionnée automatiquement.

C Aperçu de l'écran de configuration

Appuyez sur le bouton  pour accéder à l'écran de configuration puis sélectionnez la fonction ou l'option souhaitée.

Air-conditionner

- 01 Affichage Silence
 - Affiche la fonction Silence.
- 02 Affichage Nuit
 - Affiche la fonction Nuit.
- 03 Affichage Lg portée
 - Affiche la fonction Lg portée.
- 04 Affichage Prog.
 - Affiche n'importe laquelle de ces options : Minuteur, Programmation hebdo., Programmation annuelle, et Programmation Vacances.
- 05 Affichage Nettoyage
 - Affiche la fonction Nettoyage.
- 06 Affichage Qualité air
 - Affiche la Qualité air.
- 07 Affichage Option
 - Affiche l'Option.
- 08 Affichage Énergie
 - Affiche n'importe laquelle de ces options : Conso. énergétique, Economie d'énergies, et Réglages énergétiques.

Ventilateur

- 01 Affichage Nettoyage
 - Affiche la fonction Nettoyage.
 - 02 Affichage Éco énergie
 - Affiche la fonction Éco énergie.
 - 03 Affichage Prog.
 - Affiche n'importe laquelle de ces options : Minuteur, Programmation hebdo., Programmation annuelle, et Programmation Vacances.
 - 04 Affichage Option
 - Affiche l'Option.
- REMARQUE**
- Les fonctions indisponibles apparaissent inactives et ne peuvent être configurées.
 - Dans le menu avec > dans le menu Option, vous pouvez sélectionner un menu au moyen du bouton >.
 - Lorsque vous n'appuyez sur aucun bouton pendant 180 secondes avec l'option active, les réglages ne sont pas enregistrés et l'écran d'accueil apparaît.

Aparelho de ar condicionado

- | | | | |
|----|--|----|--|
| 01 | Visor da temperatura definida | 08 | Indicador Programação |
| 02 | Visor da temperatura atual | - | Quando um Horário geral é definido. |
| 03 | Visor do modo de funcionamento | - | Quando um Horário de vazio é definido. |
| - | Exibe Auto, Arref., Desum., Vent. e Aquec. | 09 | Indicador Limpar |
| 04 | Visor da velocidade da ventoinha | 10 | Indicador Bloquear |
| - | Exibe Auto, Turbo, Alto, Médio e Baixo. | 11 | Indicador de verificação |
| 05 | Visor Wind-Free | 12 | Indicador Reiniciar filtro |
| 06 | Visor da direção do fluxo de ar | 13 | Indicador Descongelação |
| - | Exibe Corrigir, Localizado, Médio, Disperso, Oscilação e Individual. | 14 | Indicador Controlo central |
| 07 | Visor Configuração da hora de início | 15 | Indicador Temperatura de insuflação |
| - | Quando Temporizador de economia de energia é ativado. | | |
| - | Quando o tempo Sobreposição é ativado. | | |

Ventilador

- | | | | |
|----|--|-------------|---|
| 01 | Visor da temperatura atual | 07 | Indicador Reiniciar filtro |
| 02 | Visor do modo de funcionamento | 08 | Indicador Descongelação |
| - | Exibe Recup., Auto, By-Pass, Silencioso e Ausente. | 09 | Indicador Controlo central |
| 03 | Visor da velocidade da ventoinha | 10 | Indicador Exaustor |
| - | Exibe Auto, Turbo, Alto e Baixo. | | |
| 04 | Indicador Programação | NOTA | |
| - | Quando um Horário geral é definido. | • | As funções indisponíveis estão marcadas como inativas e não podem ser definidas. |
| - | Quando um Horário de vazio é definido. | • | A localização dos ícones pode diferir consoante a função. |
| 05 | Indicador Bloquear | • | Se não premir qualquer botão durante 7 segundos, a função da posição é selecionada automaticamente. |
| 06 | Indicador de verificação | | |

C Descrição geral do ecrã de definições

Prima o botão  para entrar no ecrã de definições e, em seguida, selecione a função ou opção pretendida.

Aparelho de ar condicionado

- | | | | |
|----|---|----|---|
| 01 | Visor Silencioso | 05 | Visor Limpeza |
| - | Exibe a função Silencioso. | - | Exibe a função Limpeza. |
| 02 | Visor Noturno | 06 | Visor Qualidade ar |
| - | Exibe a função Noturno. | - | Exibe a Qualidade ar. |
| 03 | Visor Long Wind | 07 | Visor Opção |
| - | Exibe a função Long Wind. | - | Exibe a Opção. |
| 04 | Visor Program. | 08 | Visor Energia |
| - | Exibe Temporizador, Programação semanal, Progr. anual e Def. Modo Férias. | - | Exibe Utiliz. energia, Poupança energia e Definições energia. |

Ventilador

- | | | | |
|----|---|-------------|--|
| 01 | Visor Limpeza | NOTA | |
| - | Exibe a função Limpeza. | • | As funções indisponíveis estão marcadas como inativas e não podem ser definidas. |
| 02 | Visor P. energia | • | No menu com o > no menu Opção, pode selecionar um menu com o botão >. |
| - | Exibe a função P. energia. | • | Se não premir qualquer botão durante 180 segundos com a opção ativa, as definições não são guardadas e aparece o ecrã inicial. |
| 03 | Visor Program. | | |
| - | Exibe Temporizador, Programação semanal, Progr. anual e Def. Modo Férias. | | |
| 04 | Visor Opção | | |
| - | Exibe a Opção. | | |

Klimaanlage

- 01 Solltemperaturanzeige
- 02 Aktuelle Temperaturanzeige
- 03 Betriebsmodusanzeige
 - Anzeige der Betriebsmodi Auto, Kühlen, Dry, Lüfter und Heiz.
- 04 Ventilatorgeschwindigkeitsanzeige
 - Anzeige der Betriebsmodi Auto, Turbo, Hoch, Mittel und Niedrig.
- 05 Wind-Free-Anzeige
- 06 Gebläsestromrichtungsanzeige
 - Anzeige der Betriebsmodi Fix, Punkt, Mitte, Weit, Schwingen und Individuell.
- 07 Aktivierung Zeit Einstellungen-Display
 - Wenn Energiespar Timer aktiviert ist.
 - Wenn Übersteuern-Zeit aktiviert ist.
- 08 Zeitplan-Anzeige
 - Wenn ein Allgemeiner Zeitplan eingestellt ist.
 - Wenn ein Zeitplan Absenkung eingestellt ist.
- 09 Reinigen-Anzeige
- 10 Verriegeln-Anzeige
- 11 Einstellungen-Anzeige
- 12 Filter zurücksetzen-Anzeige
- 13 Abtaubetrieb-Anzeige
- 14 Zentralsteuerung-Anzeige
- 15 Ausblastemperatur-Anzeige

Ventilator

- 01 Aktuelle Temperaturanzeige
- 02 Betriebsmodusanzeige
 - Anzeige der Betriebsmodi WT, Auto, By-Pass, Leise und Abwesend.
- 03 Ventilatorgeschwindigkeitsanzeige
 - Anzeige der Betriebsmodi Auto, Turbo, Hoch und Niedrig.
- 04 Zeitplan-Anzeige
 - Wenn ein Allgemeiner Zeitplan eingestellt ist.
 - Wenn ein Zeitplan Absenkung eingestellt ist.
- 05 Verriegeln-Anzeige
- 06 Einstellungen-Anzeige
- 07 Filter zurücksetzen-Anzeige
- 08 Abtaubetrieb-Anzeige
- 09 Zentralsteuerung-Anzeige
- 10 Haube-Anzeige (Abzugshaube)

HINWEIS

- Nicht verfügbare Funktionen werden als inaktiv markiert und können nicht eingestellt werden.
- Die Position der Symbole kann je nach Funktion variieren.
- Wenn Sie 7 Sekunden lang keine Taste drücken, wird automatisch die Funktion der Position ausgewählt.

C Einstellungsbildschirm-Übersicht

Drücken Sie die Taste  um den Einstellungsbildschirm aufzurufen, und wählen Sie dann die gewünschte Funktion oder Option aus.

Klimaanlage

- 01 Leise-Anzeige
 - Zeigt die Leise-Funktion an.
- 02 Schlaf-Anzeige
 - Zeigt die Schlaf-Funktion an.
- 03 Langer Wind-Anzeige
 - Zeigt die Langer Wind-Funktion an.
- 04 Zeitplan-Anzeige
 - Anzeige der Einstellungen Timer, Wöchentlicher Zeitplan, Jährlicher Zeitplan und Urlaub.
- 05 Reinigen-Anzeige
 - Zeigt die Reinigen-Funktion an.
- 06 Luftqualität-Anzeige
 - Zeigt die Luftqualität an.
- 07 Optionsanzeige
 - Zeigt die Option an.
- 08 Energie-Anzeige
 - Anzeige der Einstellungen Energieverbrauch, Energiesparen und Energie-Einstellungen.

Ventilator

- 01 Reinigen-Anzeige
 - Zeigt die Reinigen-Funktion an.
- 02 E-Saver-Anzeige
 - Zeigt die E-Saver-Funktion an.
- 03 Zeitplan-Anzeige
 - Anzeige der Einstellungen Timer, Wöchentlicher Zeitplan, Jährlicher Zeitplan und Urlaub.
- 04 Optionsanzeige
 - Zeigt die Option an.
- 05 **HINWEIS**
 - Nicht verfügbare Funktionen werden als inaktiv markiert und können nicht eingestellt werden.
 - Im Menü mit dem Symbol > im Optionsmenü kann das Menü mit der Taste > ausgewählt werden.
 - Wenn Sie bei aktivierter Option 180 Sekunden lang keine Taste drücken, werden die Einstellungen nicht gespeichert und der Startbildschirm wird angezeigt.

Airconditioner

- 01 Temperatuurweergave instellen
- 02 Weergave huidige temperatuur
- 03 Weergave werkingsmodus
 - Toont een van de volgende opties: Auto, Koelen, Dry, Fan en Heat.
- 04 Weergave fan snelheid
 - Toont een van de volgende opties: Auto, Turbo, Hoog, Medium en Laag.
- 05 Weergave Wind Free
- 06 Weergave richting luchtstroom
 - Toont een van de volgende opties: Vast, Lokaal, Mid, Breed, Draaien en Individueel.
- 07 Weergave Starttijd instellen
 - Wanneer Energiebesparing timer geactiveerd is.
 - Wanneer Overnemen-tijd geactiveerd is.
- 08 Indicator Schema
 - Wanneer een Programma ingesteld is.
 - Wanneer een Uitgesteld schema ingesteld is.
- 09 Indicator Schoonmaken
- 10 Indicator Vergrendelen
- 11 Indicator Controle
- 12 Indicator Filter resetten
- 13 Indicator Ontdooien
- 14 Indicator Centrale regeling
- 15 Indicator Afvoertemperatuur

Ventilator

- 01 Weergave huidige temperatuur
 - 02 Weergave werkingsmodus
 - Toont een van de volgende opties: Heat-EX, Auto, By-Pass, Stil en Afwezig.
 - 03 Weergave fan snelheid
 - Toont een van de volgende opties: Auto, Turbo, Hoog en Laag.
 - 04 Indicator Schema
 - Wanneer een Programma ingesteld is.
 - Wanneer een Uitgesteld schema ingesteld is.
 - 05 Indicator Vergrendelen
 - 06 Indicator Controle
 - 07 Indicator Filter resetten
 - 08 Indicator Ontdooien
 - 09 Indicator Centrale regeling
 - 10 Indicator Afzuigkap
- OPMERKING**
- Niet-beschikbare functies worden gemarkeerd als inactief en kunnen niet worden ingesteld.
 - Afhankelijk van de functie kunnen de locaties van pictogrammen verschillen.
 - Wanneer u 7 seconden lang op geen enkele knop drukt, wordt de aangegeven functie automatisch geselecteerd.

C Overzicht scherm Instellingen

Druk op de knop  om het scherm Instellingen te openen en vervolgens de gewenste functie of optie te selecteren.

Airconditioner

- 01 Weergave Stil
 - Toont de functie Stil.
- 02 Weergave Slapen
 - Toont de functie Slapen.
- 03 Weergave Lang draaien
 - Toont de functie Lang draaien.
- 04 Weergave Schema
 - Toont een van de volgende opties: Timer, Weekschema, Jaarschema en Feestdag.
- 05 Weergave Clean
 - Toont de functie Clean.
- 06 Weergave Luchtkwaliteit
 - Toont de Luchtkwaliteit.
- 07 Weergave Optie
 - Toont de Optie.
- 08 Weergave Energie
 - Toont een van de volgende opties: Energieverbruik, Energiebesparing en Energie-instellingen.

Ventilator

- 01 Weergave Reiniging
 - Toont de functie Reiniging.
 - 02 Weergave Eco
 - Toont de functie Eco.
 - 03 Weergave Schema
 - Toont een van de volgende opties: Timer, Weekschema, Jaarschema en Feestdag.
 - 04 Weergave Optie
 - Toont de Optie.
- OPMERKING**
- Niet-beschikbare functies worden gemarkeerd als inactief en kunnen niet worden ingesteld.
 - In het menu met de > in het menu Optie kunt u een menu selecteren met de knop >.
 - Als u gedurende 180 seconden geen enkele knop indrukt terwijl de optie actief is, worden de instellingen niet opgeslagen en wordt het startscherm weergegeven.

Contents

Safety Information	3
Safety Information	3
Power Smart Features	5
Remote Controller Operation	5
Operation modes • Controlling temperature • Controlling fan speed	5
Controlling air flow direction	6
Cooling Operation	7
Cool mode • Wind-Free function	7
Dehumidifying Operation	8
Dry mode	8
Air Purifying Operation	8
Purify function	8
Heating Operation	9
Heat mode	9
Quick Smart Features	9
Auto mode • Fan mode	9
Quiet function • Sleep function • Long Wind function	10
Ventilation (ERV) Operation	11
Ventilation (ERV) Operation	11
Operation modes • Controlling fan speed	11
E-Saver function • Clean up function	12
Energy-Saving Operation	13
Energy-Saving Operation	13
Schedule	13
Energy	14
Setting Options	15
Setting Options	15
How to set the Options	15
Current Time Setting (Example)	17

The lowest set temperature is limited to 20 degree in the UAE according to UAE.S 5010-5:2016.

Safety Information





This content is intended to protect the user's safety and prevent property damage. Please read it carefully for correct use of the product.

WARNING

Hazards or unsafe practices that may result in severe personal injury or death.



CAUTION

Hazards or unsafe practices that may result in minor personal injury or property damage.

- | | |
|---|---|
|  Follow directions. |  Do NOT attempt. |
|  Make sure the machine is grounded to prevent electric shock. | |
|  Unplug the appliance. |  Do NOT disassemble. |

FOR INSTALLATION

WARNING

-  The installation of this appliance must be performed by a qualified technician or service company.
 - Failing to do so may result in electric shock, fire, explosion, problems with the product, or injury.**You must connect the product with rated power upon installation.**
 - Failing to do so may result in problems with the product, electric shock, or fire.
-  Do not install this appliance near a heater, inflammable material. Do not install this appliance in a humid, oily or dusty location, in a location exposed to direct sunlight and water (rain drops). Do not install this appliance in a location where gas may leak.
 - Failing to do so may result in electric shock or fire.

CAUTION

-  Install the product on a hard and even place that can support its weight.
 - If the place cannot support its weight, the product may fall down and it may cause product damage.

FOR POWER SUPPLY

WARNING

-  Do not bend or pull the power cord excessively. Do not twist or tie up the power cord.
 - Failing to do so may result in electric shock or fire.

Safety Information

FOR OPERATION

WARNING

 If the appliance generates a strange noise, a burning smell or smoke, unplug the product immediately and contact your nearest service centre.

- Failing to do so may result in electric shock or fire.

To reinstall the air conditioner, please contact your nearest service centre.

- Failing to do so may result in problems with the product, water leakage, electric shock, or fire.
- A delivery service for the product is not provided. If you reinstall the product in another location, additional construction expenses and an installation fee will be charged.

If the malfunction diagnosis indicator appears or malfunctions, then stop operation immediately.

- If you detect any burning smells from the product or it malfunctions, then immediately turn off the air conditioner/Ventilator(ERV) and power, and then contact the service centre. Continuing to use the device in this state can cause electrical shock, fire, or damage to the product.
- If the E836 indicator appears, then it means that it is time to contact the service centre for periodic inspection. Neglecting these periodic inspections can result in malfunctions (only applicable to GHP model).

 Do not attempt to repair, disassemble, or modify the product yourself.

- Failing to do so may result in electric shock, fire, product malfunction, or injury.

CAUTION

 Do not allow water to enter the product.

- Failing to do so may result in fire or explosion.

 Do not operate the product with wet hands.

- Failing to do so may result in electric shock.

Do not spray volatile material such as insecticide onto the surface of the product.

- As well as being harmful to humans, it may also result in electric shock, fire, or product malfunction.

Do not give a strong impact to the product and do not disassemble the product.

Do not use this product for other purposes.

- This product is designed to be used only for a system air conditioner.

Do not press the buttons with any sharp objects.

- Failing to do so may result in electric shock or part damage.

FOR CLEANING

WARNING

 Do not clean the product by spraying water directly onto it. Do not use benzene, thinner, alcohol or acetone to clean the product.

- Failing to do so may result in discoloration, deformation, damage, electric shock, or fire.

Remote Controller Operation

You can use the air conditioner easily by selecting a mode and then by controlling the temperature, fan speed, and air flow direction.

Use the \langle and \rangle buttons to select the desired menu, press the **OK** button, use the \wedge , \vee buttons to select the desired item, and then press the **OK** button.

Operation modes

You can change the current mode to Auto, Cool, Dry, Fan, and Heat.

Controlling temperature

You can control the temperature in each mode as follows:











Mode	Temperature control
Auto/Cool/Dry	Adjust by 1 °C (1 °F) between 18 °C (65 °F) and 30 °C (86 °F).
Fan	You cannot control the temperature.
Heat	Adjust by 1 °C (1 °F) between 16 °C (61 °F) and 30 °C (86 °F).

NOTE

- The set temperature range available on the remote controller may change depending on the set temperature range that indoor unit supports.

Controlling fan speed

You can select the following fan speeds in each mode:

Mode	Available fan speeds
Auto/Dry	 AUTO Auto
Cool/Heat	 AUTO Auto,  Turbo,  High,  Medium,  Low
Fan	 Turbo,  High,  Medium,  Low

NOTE

-  Turbo appears active only on the indoor unit that supports the Turbo fan speed.

Remote Controller Operation

Controlling air flow direction

You can control air flow direction.

General models	Fix, Swing, Swing, Swing, Individual
360 cassette model	Spot, Mid, Wide, Swing 360, Individual

- For 360-cassette indoor unit

Mode	Wired remote controller display	Indoor unit indicator
Spot	Spot	
Mid	Mid	
Wide	Wide	
Swing	Swing 360	

- If 360-cassette indoor units and other indoor units are installed together, the air flow direction does not change on the indoor units other than 360-cassette when Spot, Mid, or Wide is started as the air flow direction.
- You can select individual air flow direction for each blade, when the individual indication appears active on the indoor unit that supports this mode.

NOTE

- The displayed flow direction icon may differ depending on the indoor model.
- The current air flow direction persists even if you change the current mode, or turn off and then turn on the remote controller.
- Blades that can be selected for Individual may differ depending on the product model.
- When Blade lock is set, the locked blade appears inactive.

Cooling Operation

The smart and powerful cooling functions of the Samsung air conditioner keep an enclosed space cool and comfortable.

Cool mode

Use the Cool mode to stay cool in hot weather.

NOTE

- It is recommended to set the desired temperature between 24 °C (75 °F) and 26 °C (79 °F).
- To cool your room quickly, select a low temperature and a high fan speed.
- To save energy, select a high temperature and a low fan speed.
- As the indoor temperature approaches the set temperature, the compressor will operate at a low speed to save energy.

Wind-Free function

Use the Wind-Free function to enjoy mild cool breeze exuding from fine holes on the Wind-Free panel with the air flow blade closed, instead of getting cool wind directly. The automated control of the temperature and fan speed according to the indoor temperatures keeps your room cool and pleasant.

NOTE

- If the Wind-Free function is cancelled, the air conditioner returns to the previous fan speed.
- You can adjust the set temperature during the Wind-Free function, and recommended set temperatures are 24 to 26 °C (75 to 79 °F). However, you cannot change the set temperature in the Fan mode.
- You can use the Wind-Free function when the Cool, Dry, or Fan mode is running.
- If the room temperature increases because of rise of external temperature, heat from cooking, or other reason, operate normal cooling first to lower the temperature, before operating Wind-Free to keep the desired temperature.
- If you select the Wind-Free function in the Fan mode, the compressor stops working so that cool air does not come out. However, mild breeze comes out and starts to clean the air in the room.
- During the Wind-Free operation, the cold air may be intermittently weakened depending on the temperature and humidity in the room. But the wind-free air currents are maintained and the weakened cold air is immediately recovered, consequently keeping the room comfortable. (During the Wind-Free operation, the air flow blades may open to control the indoor air condition smoothly, depending on the installation settings. In this case, as soon as the indoor temperature and humidity change, the air flow blades are closed and the Wind-Free operation restarts. For more information on the installation settings, see "Setting the indoor unit addresses and the installation options" in the installation manual of the indoor unit.)

Change of the air flow blade by temperature and humidity

Indoor temperature and humidity	Low	High	
	Breeze is blown via the micro holes on the air flow blades	Breeze is blown via the micro holes on the air flow blades	Breeze comes from the air flow blade depending on the setting
Air flow blade	Closed	Closed (default)	Opened (according to setting)

- When the Wind-Free function runs while sleeping, you may feel cold air if the air conditioner is installed over the bed. In this case, set the desired temperature higher than the normal setting temperature.

Dehumidifying Operation

The dehumidifying function of the Samsung air conditioner keeps an enclosed space dry and comfortable.

Dry mode

Use the Dry mode in rainy or humid weather.

NOTE

- You cannot change fan speed in the Dry mode.
- The greater the difference between room temperature and set temperature, the longer the needed time to dehumidify the air is.

Air Purifying Operation

The air purification function of the Samsung air conditioner keeps the air in an enclosed space purified.

Purify function

Use the Purify function to remove harmful materials in the air to provide you a clean and healthy environment.

This function is available in the Auto, Cool, Dry, Fan, and Heat modes.

NOTE

- During the Air Purifying operation, dust is collected on the active filter panel.
- When the Purify function is additionally selected in the Fan mode, you cannot change the set temperature.
- When the Purify function is additionally selected while a specific mode is running, there is little difference in electricity consumption and operating noise.

Air purity level indications

- The indications are displayed only on the models that support the air purity level display function.
- The air purity levels for PM10, PM2.5, and PM1.0 appear as follows:

Purity level	PM10		PM2.5/PM1.0	
	Colour	Concentration (μm^3)	Colour	Concentration (μm^3)
Very Poor	Red	151 or more	Red	76 or more
Poor	Yellow	81-150	Yellow	36-75
Normal	Green	31-80	Green	16-35
Good	Blue	30 or less	Blue	15 or less

- When you set **Air Quality** to **ON**, the screen saver displays the current air purity level details.
 - You can set the screen saver launch time in **Option > User mode**.
- Air purity level can only be displayed on indoor units supporting this function.

Heating Operation

The heating functions of the Samsung air conditioner keep an enclosed space warm and comfortable.

Heat mode

Use the Heat mode to stay warm.

NOTE

- While the air conditioner warms up, the fan may not operate for a while at the beginning to prevent cold wind.
- If the outdoor temperature is low and the humidity is high while the Heat mode is running, the heating performance of the air conditioner may decrease due to frost or ice that forms on the outdoor heat exchanger. When this condition happens, the air conditioner runs the Defrost function for about 5 to 12 minutes to remove the frost and ice, both water and steam are released from the outdoor unit.
- While the Defrost function is running, the indoor unit provides no breeze to prevent cold wind.
- The operation time of the Defrost function varies depending on the amount of the frost and ice and the humidity.
- While the Defrost function is running, none of other functions will work, even if you select them on the remote controller.

Quick Smart Features

There is a variety of useful functionality provided by the Samsung air conditioner.

Auto mode

Use the Auto mode when you want the air conditioner to automatically control the mode (Heat or Cool). The air conditioner will provide the most comfortable atmosphere that it can.

NOTE

- You cannot change the fan speed.
- While the Cool mode is running, the air conditioner produces a strong cold air if there is a large difference between the set temperature and the current temperature. When the temperature difference becomes small, the air conditioner automatically changes the air flow direction and keeps the room at a comfortable temperature.

Fan mode

Use the Fan mode to run the air conditioner like a common fan. The air conditioner provides a natural breeze.

NOTE

- If the air conditioner will not be used for an extended period of time, dry the air conditioner by running it in the Fan mode between 3 and 4 hours.

Quick Smart Features

Quiet function

Quiet function decreases the operation sound in the Auto, Cool, Dry, or Heat mode.

NOTE

- You can control the set temperature, fan speed, and air flow direction.
- When you select Quiet in Wind-Free or Long Wind function, the previous function is cancelled.

Sleep function

Sleep function automatically turns off the air conditioner after 6 hours without stopping the operation in the middle of the night.

NOTE

- You can select this function only in the Cool and Heat modes.
- You can control the set temperature, fan speed, and air flow direction.
- When you select Sleep in Wind-Free or Long Wind function, the previous function is cancelled.

Long Wind function

Use the Long Wind function to quickly deliver a long reaching air flow.

NOTE

- You can select this function only in the Cool, Dry, and Fan modes.
- You cannot control the fan speed and air flow direction.
- When you select Long Wind in the Wind-Free, Quiet, or Sleep function, the previous function is cancelled.

Ventilation (ERV) Operation

Operation modes

You can select the desired mode.

Mode	Description
Heat-EX	This mode minimizes energy loss by recovering energy from the exhaust air during indoor heating or cooling.
Auto	This mode automatically adjusts the ventilation functions depending on the degree of pollution in your indoor air.
By-Pass	This mode activates the intake of external air so that it comes indoors.
Quiet	This mode reduces the sound produced by the ventilator (ERV).
Away	This mode allows you to operate the ventilator (ERV) while you are away from home.

NOTE

- Only when you select all the options of ventilator (ERV), you can use the above operation. (Only available when the wired remote controller is installed)
- If the operation status is changed by another controller, the operation mode is cancelled.

Controlling fan speed

You can select the following fan speeds in each mode:

Heat-EX/Auto/ By-Pass	 AUTO Auto,  Turbo,  High,  Medium
Quiet/Away	 Medium

NOTE

-  AUTO Auto appears active only on the ventilator that supports the Auto fan speed.

Ventilation (ERV) Operation

E-Saver function

Reduce your power consumption and save money on your electric bill.

- When the ventilator (ERV) and the air conditioner is connected together
 - This function compares the outdoor and indoor temperatures, and then automatically selects Heat-EX or By-Pass operation.
- When the ventilator (ERV) is installed separately (depending on the option settings at installation), it operates as follows:

ON/OFF Alternation operation	<ul style="list-style-type: none">• The ventilator (ERV) turns On and Off in Quiet (Medium) mode every 30 minutes.
Outdoor air cooling operation for different temp. setting	<ul style="list-style-type: none">• Operates when the View Master is for ERV+.• With the temperature control button, the default temperature for E-Saver can be set.• Depending on the set temperature, it automatically selects Heat-EX or By-Pass operation.

NOTE

- When the air conditioner is connected individually, E-Saver function is not available.

Clean up function

Prevent odor and dust from entering by making the airflow input bigger than the airflow output.

Energy-Saving Operation

The Samsung air conditioner provides functions that allow you to reduce electricity consumption.

Schedule

Press the  button, press the   or  button to select **Schedule**, and then press the **OK** button.

You can set each of **General Schedule**, **Setback Schedule**, **Override**, **Energy Saving Timer**, **Eco Setting**, and **Activation Time Setting**.

Type	Description
General Schedule	Timer <ul style="list-style-type: none"> • Turns the device on or off after a set time. <ul style="list-style-type: none"> – You can set the timer by 5 minute increments.
	Weekly schedule <ul style="list-style-type: none"> • Schedules the operation of the device on a set day and at a set time. <ul style="list-style-type: none"> – You can schedule on the weekly basis. You can also set the values for day, time, operation on/off, scheduled device, and operation status (operation mode, set temperature, fan speed).
	Yearly schedule <ul style="list-style-type: none"> • Creates groups for the desired months for scheduling <ul style="list-style-type: none"> – You can schedule up to 8 groups on the yearly basis.
	Holiday <ul style="list-style-type: none"> • Allows you not to make use of the schedule on holidays.
Setback Schedule	<ul style="list-style-type: none"> • Controls the indoor unit with 4 different operation patterns. <ul style="list-style-type: none"> – Each pattern sets the values for time, operation (OFF, Cool, Heat, Auto), and the set temperature.
Override	Allows you to run at a specific time the operation you set using Energy Saving Timer.
Energy Saving Timer	<ul style="list-style-type: none"> • When set to "Turn off" <ul style="list-style-type: none"> – If the indoor unit is turned on, the indoor unit turns off after the set time elapses. • When set to "Eco Setting" <ul style="list-style-type: none"> – If the current temperature continues to differ from the reference cooling or heating temperature set in Eco Setting, the indoor unit returns to the temperature set in Eco Setting after the set time elapses. • When set to "Setback Schedule" <ul style="list-style-type: none"> – If the most recently operated Setback Schedule status differs from the indoor unit status, the indoor unit returns to that Setback Schedule status after the set time elapses. <p>※ When "Timer Reset" is set to "Enable", the set time is re-counted if the indoor unit status changes.</p> <p>※ When a period of time is set in Activation Time Setting, the indoor unit only operates for that period of time.</p>





Energy-Saving Operation

Type	Description
Eco Setting	Allows you to set the reference cooling and heating temperatures when "Energy Saving Timer" is set to "Eco Setting".
Activation Time Setting	Allows you to make the Energy Saving Timer function operate only for the period of time you set.

 **NOTE**

- Weekly schedule and Yearly schedule can cover settings up to 49.





Energy

Press the  button, press the   or  button to select **Energy**, and then press the **OK** button. You can see and set any of Energy Usage and Energy Setting.

Classification	Type	Description
Energy Usage	-	Displays the Instantaneous Power, Weekly Energy Usage, Monthly Energy Usage, Yearly Energy Usage, Energy Usage over Last Year, and Operation Time in graph format.  NOTE <ul style="list-style-type: none"> For accuracy of operation time, use the DMS time synchronization. The weekly display follows the ISO 8601 standards.
Energy Setting	Set Outdoor Capacity	Controls the outdoor unit's operation capacity.
	Target Energy Consumption	Sets the target energy consumption.
	Target Operation Time	Sets the target operation time.
	Alarm Popup	Sets whether or not to generate an alarm when the target energy consumption is reached.
	Usage Data Initialization	Initialises the entire energy function.

Setting Options

How to set the Options

- 1 Press the  button.
- 2 Press the   or  button to select Option, and then press the **OK** button.
- 3 See the following pages to select the desired menu.

Major	Step1	Step2	Step3	Step4	Step5	Description	Default		
General	Button lock					ON/OFF	-		
	Filter reset	Indoor					-		
		Ventilator					-		
	Error list						-		
	Indoor unit information						-		
Indoor	Blade selection					4-way cassette: Swing ON/Swing OFF 360 cassette: Spot/Mid/Wide	-		
	Motion detect sensor	Set Motion detect sensor				ON/OFF	OFF		
		Motion detection type				Indirect Wind/Direct Wind	Indirect Wind		
Option	User mode	Language				Differs depending on the language	First value for the language pack		
		Daylight Savings Time	Daylight Savings Time				ON/OFF	OFF	
			Unit				Day/Week	Week	
			Week	Start Month				January to December	Mar
				Start Week				1st to 4th, Final (final week)	F (final week)
				End Month				January to December	Oct
				End Week				1st to 4th, Final (final week)	F (final week)
			Day	Start Month				January to December	Mar
				Start Day				1-31	22
		End Month					January to December	Sep	
		End Day					1-31	22	
		Air Purify Display	PM10				ON/OFF	ON	
			PM2.5				ON/OFF	ON	
PM1.0					ON/OFF	OFF			

Setting Options



















Major	Step1	Step2	Step3	Step4	Step5	Description	Default		
Option	User mode	Lock	All lock			ON/OFF	OFF		
			Partial Lock Fuction	Operation Lock			ON/OFF	OFF	
				Operation mode Lock	All mode Lock			ON/OFF	OFF
					Auto mode Lock			ON/OFF	OFF
					Cool mode Lock			ON/OFF	OFF
					Dry mode Lock			ON/OFF	OFF
					Heat mode Lock			ON/OFF	OFF
					Fan mode Lock			ON/OFF	OFF
				Temperature Lock			ON/OFF	OFF	
				Fan speed Lock			ON/OFF	OFF	
				Additional Mode Lock	Wind-Free Lock			ON/OFF	OFF
			Long Wind Lock				ON/OFF	OFF	
			Quiet Lock				ON/OFF	OFF	
			Sleep Lock				ON/OFF	OFF	
		Schedule Lock			ON/OFF	OFF			
		Wired remote controller	LED				ON/OFF	ON	
			Button Mute				ON/OFF	OFF	
			Wireless remote controller				ON/OFF	OFF	
			Current time	Date			2000 to 2099/1 to 12/1 to 31	2018.01.01.	
				Time			12-Hour/24-hour 12-hour format : 1 to 12, 24-hour format: 0 to 23, minutes: 00 to 59	12:00 PM	
			Reset remote controller				-	-	
			Display setting	Brightness			10 to 100%	100%	
				Screen saver	Timer			10 to 60 seconds	30 sec
					Brightness			0,10, 30, 50, 70%	30%
			Smart Reset					-	
			Reset All User modes					-	

Major	Step1	Step 2	Step 3	Step 4	Step 5	Description	Default	
Option	User mode	Auto changeover	Use of wired remote controller DSP			ON/OFF	OFF	
			Cooling Set temp./Heating Set temp.			18°C to 30°C (Set temp range for auto operation of the indoor unit)	Indoor unit status value	
			Primary			0.5°C to 2°C(or 1°F to 4°F)	Indoor unit status value	
			Secondary			0.5°C to 2°C(or 1°F to 4°F)	Indoor unit status value	
		Temperature limits	Lower Limit			Celsius: 8 to 30°C Fahrenheit: 47 to 86°F	8°C	
			Upper Limit			Celsius: 8 to 30°C Fahrenheit: 47 to 86°F	30°C	
		Easy tuning				-2 to +2	0	
		Indoor lighting				ON/OFF	Indoor unit status value	
		Clean				ON/OFF	Indoor unit status value	
		Delay time	Use of ERV delay time				ON/OFF	OFF
			ERV delay time				30 to 60 minutes	30

NOTE

- When two wired remote controllers are connected, the brightness can be set within 10 to 50%.

Current Time Setting (Example)

- Press the  button.
- Press the   or  button to select **Option**, and then press the **OK** button.
- Press the   or  button to select **User mode**, and then press the **OK** button.
- Press the   or  button to select **Wired remote controller**, and then press the **OK** button.
- Press the   or  button to select **Current time**, and then press the **OK** button.
- Press the   or  button to select **Time**, and then press the **OK** button.
- Press the   or  button to select Time format, Hour, Minute, and AM/PM, and then press the **OK** button.

Memo



SAMSUNG

