

SAMSUNG

SYSTEM AIRCONDITIONER

INDOOR UNIT

AM045/056/071/090/112/128/140NN4DEH/**

AM015/022/028/036/045/056/060NNNDEH/**

AM009/012/018/024/036/048NN4DCH/**

AM005/007/009/012/018/020NNNDCH/**

SERVICE *Manual*

SYSTEM AIRCONDITIONER



CONTENTS

1. Precautions
2. Product Specifications
3. Disassembly and Reassembly
4. Troubleshooting
5. PCB Diagram and Parts List
6. Wiring Diagram
7. Reference Sheet

Contents

1. Precautions	5
1-1 Precautions for the Service.....	5
1-2 Precautions for the Static Electricity and PL.....	5
1-3 Precautions for the Safety	5
1-4 Precautions for Handling Refrigerant for Air Conditioner.....	6
1-5 Precautions for Welding the Air Conditioner Pipe.....	6
1-6 Precautions for Additional Supplement of Air Conditioner Refrigerant	6
1-7 Other Precautions.....	6
2. Product Specifications	7
2-1 Product Specifications	7
2-1-1 Indoor Unit.....	7
2-2 Accessory and Option Specifications	13
2-2-1 Accessories	13
3. Disassembly and Reassembly	16
3-1 Indoor Unit	17
4. Troubleshooting	24
4-1 Check-up Window Description.....	24
4-2 Service Operation	25
4-2-1 Special Operation.....	25
4-2-2 DVM S Models EEPROM Code Table.....	29
4-3 Troubleshooting	30
4-3-1 Setting Option Setup Method	30
4-3-2 Option Items.....	41
4-3-3 What to check before diagnosis.....	42
4-3-4 Number Display Method (Outdoor Unit, MCU, Cable remote control, wall-mount, etc.).....	44
4-4 Appropriate Measures for Different Symptom	50
4-4-1 Outdoor Unit Operation Flow.....	50
4-4-2 Main PCB has no power phenomenon.....	51
4-4-3 Indoor Unit ROOM sensor Error (Open/Short)	52
4-4-4 Indoor unit EVAP IN sensor Error (Open/Short).....	53
4-4-5 Indoor EVAP OUT sensor Error (Open/Short).....	54
4-4-6 Indoor Heat Exchanger's EVAP IN sensor dislocation error.....	55
4-4-7 Indoor Heat Exchanger's EVA OUT sensor dislocation error (Open/Short)	56
4-4-8 simultaneous Indoor Heat Exchanger's EVA IN, OUT sensor dislocation error (Open/Short).....	57
4-4-9 Electronic Expansion Valve opening malfunction (2nd stage) - <i>E 135</i>	58
4-4-10 Breakdown of EEV (2nd)	59
4-4-11 Problem with EEV closure (2nd).....	60
4-4-12 EEV(Electronic Expansion Valve) opening malfunction (2nd stage)	61
4-4-13 <i>E 152</i> : EEV(Electronic Expansion Valve) closure malfunction (2nd stage)	62
4-4-14 <i>E 153</i> : Detection of Floating Switch of Indoor Unit's Drain Pump.....	63
4-4-15 The operational error of Indoor Unit's Fan Motor.....	64
4-4-16 Mixed operation Error (Only applicable to Heat Pump Model/Not to HR model).....	65
4-4-17 EEPROM error	66
4-4-18 Option error of the Remote Controller for an Indoor Unit	67
4-4-19 Error due to confused use of Fahrenheit and Celsius	67
4-4-20 Simultaneous opening of Cooling/heating MCU SOL Valves 1st/2nd	68
4-4-21 Error due to incorrect Indoor Unit Power/Communication Cable Connection.....	69
4-4-22 SPI Feedback Error.....	70
4-4-23 Outdoor Unit Pipe Inspection Error.....	71
4-4-24 Communication Error between Indoor and Outdoor Units during Tracking	72
4-4-25 Communication Error between Indoor and Outdoor Units after Tracking	73
4-4-26 Communication error between main and sub Unit of outdoor unit or between outdoor units.....	74
4-4-27 Communication Error between MCU and Outdoor Unit	75
4-4-28 Internal Communication error of the Outdoor Unit C-Box.....	76
4-4-29 Internal PCB Communication error of the Outdoor Unit C-Box.....	77
4-4-30 Communication Error between MCU and Outdoor Unit after Tracking is Completed	78
4-4-31 MCU branch part setup error – inconsecutive connection with the use of 2 branch parts.....	79
4-4-32 MCU branch part setup error – Repeated setup for the same address over 3 times.....	80
4-4-33 MCU branch part setup error – non-installed address setup.....	81

Contents

4-4-34 Setup Error for MCU Branch part – Setup Error for MCU Quantity Used	82
4-4-35 MCU branch part setup error – Overlapping Indoor unit Address setup	83
4-4-36 MCU branch part setup error – Set as being used without connection to an Indoor unit	84
4-4-37 MCU branch part setup error – Connect an Indoor unit to a branch part not being used	85
4-4-38 MCU branch part setup error – Connect more Indoor units than what is actually set up in MCU	86
4-4-39 Outdoor Temperature Sensor Error	87
4-4-40 Outdoor Temperature dislocation error	88
4-4-41 Cond Out Temperature Sensor Error (Open/Short)	89
4-4-42 Outdoor Cond Out sensor breakaway error	90
4-4-43 Digital Compressor Discharge Temperature Sensor Error (OPEN/SHORT)	91
4-4-44 Constant Rate Compressor Discharge Temperature Sensor Error (OPEN/SHORT)	92
4-4-45 Compressor Discharge or Top 1/2 Temperature sensor error	93
4-4-46 E265 : Dislocation error of Compressor SUMP Temperature (oil temperature) Sensor	94
4-4-47 E269 : Suction Temperature sensor breakaway error	95
4-4-48 SUMP Temperature Sensor Error (OPEN/SHORT)	96
4-4-49 High Pressure sensor error (Open/Short)	97
4-4-50 Low Pressure sensor error (Open/Short)	98
4-4-51 Suction Temperature sensor error (Open/Short)	99
4-4-52 Liquid Pipe Temperature sensor error (Open/Short)	100
4-4-53 EVI In Temperature sensor error (Open/Short)	101
4-4-54 EVI Out Temperature sensor error (Open/Short)	102
4-4-55 Suction-2 Temperature Sensor Error (OPEN/SHORT)	103
4-4-56 E407 : Comp. Down due to High Pressure Protection Control	104
4-4-57 E410 : Comp. Down due to Low Pressure Protection Control	105
4-4-58 Sump Sensor Error Due to Protection Control	106
4-4-59 E416 : Comp. Down due to Compressor Discharge Temperature sensor	107
4-4-60 3-phase Input Wiring error	108
4-4-61 E428 : Comp. Down by Compression Ratio Control	109
4-4-62 EVI EEV Open error	110
4-4-63 Refrigerant Leakage Error	111
4-4-64 E440, E442 : Prohibition of the operation of Compressor due to Outdoor Temperature	112
4-4-65 High Pressure Standard Not Met before Air Conditioning (Inability to Re-operate)	113
4-4-66 CCH Malfunction and Sump Sensor Miswiring Error	114
4-4-67 Fan starting error	115
4-4-68 Fan lock error	116
4-4-69 Momentary Blackout error	117
4-4-70 Outdoor Fan Motor overheating	118
4-4-71 Outdoor Unit Fan Motor RPM Error	119
4-4-72 Fan IPM Overheat error	120
4-4-73 Over-Voltage Error of an Outdoor Fan Motor	121
4-4-74 Counter-Rotation Error of an Outdoor Fan Motor	121
4-4-75 E458 : Compressor Excess Current Error	122
4-4-76 Compressor starting error	123
4-4-77 Inverter Overcurrent error	124
4-4-78 Overvoltage / Low voltage error	125
4-4-79 DC Link voltage sensor error	126
4-4-80 Liquid Compression Prevention Control	127
4-4-81 Fan Motor Overcurrent error	128
4-4-82 Input / Output Current sensor error	129
4-4-83 Outdoor Fan PCB Overvoltage / Low voltage error	130
4-4-84 Hall IC(Fan) error	131
4-4-85 Inverter Overheat error	132
4-4-86 Model mismatching of Indoor unit	133
4-4-87 Breakdown of an EEV(1 st)	134
4-4-87 Breakdown of an EEV closure	135
4-4-88 Electronic expansion valve closing malfunction (2nd stage)	136
4-4-89 Electronic expansion valve opening malfunction (2nd stage)	137
4-4-90 Hydro Unit Water In Temperature Sensor Error (Open/Short)	138
4-4-91 Hydro Unit Water Out Temperature Sensor Error (Open/Short)	139
4-4-92 Hydro Unit Water Tank Temperature Sensor Error (Open/Short)	140
4-4-93 Emergency Error (Check the Water Piping Equipment)	141
4-4-94 Error to prevention from freezing and bursting of Heat Exchanger	142
4-4-95 Breakaway of Water Out temperature sensor	143

Contents

4-4-96 Breakaway of Flow switch	144
4-4-97 Thermostat Wiring Error	145
4-4-98 DC FAN Motor Feedback Error	146
4-4-99 Water Tank Sensor defective	147
5. PCB Diagram and Parts List	148
5-1 Indoor Unit	148
5-1-1 Wind-free 4way cassette type, mini 4way cassette	148
6. Wiring Diagram	151
6-1 Indoor	151
6-1-1 Wind-free 4way cassette type	151
7. Reference Sheet	152
7-1 Index for Model Name	152
7-1-1 Indoor Unit	152
7-1-2 Panel	153
7-2 Pump-down Method	154
7-2-1 Precautions for Pump-down	154
7-2-2 For Single Installation of Outdoor Unit (Only One Outdoor Unit Installed)	154
7-2-3 When Two or More Outdoor Units are Installed	154
7-3 How to Put Refrigerant in Refrigerant Container	155
7-3-1 How to put refrigerant in container before pump-down	155

1. Precautions

1-1 Precautions for the Service

- **Use the correct parts when changing the electric parts.**
 - Please check the labels and notices for the model name, proper voltage, and proper current for the electric parts.
- **Fully repair the connection for the types of harness when repairing the product after breakdown.**
 - A faulty connection can cause irregular noise and problems.
- **When disassembling or assembling, make sure that the product is laid down on a work cloth.**
 - Doing so will prevent scratching to the exterior of the rear side of the product.
- **Completely remove dust or foreign substances on the housing, connection, and inspection parts when performing repairs.**
 - This can prevent fire hazards for tracking, short, etc.
- **Please tighten the service valve of the outdoor unit and the valve cap of the charging valve as securely as possible by using a monkey spanner.**
- **Check whether the parts are properly and securely assembled after performing repairs.**
 - These parts should be in the same condition as before the repair.

1-2 Precautions for the Static Electricity and PL

- **Please carefully handle the PCB power terminal during repair and measurement when it is turned on since it is vulnerable to static electricity.**
 - Please wear insulation gloves before performing PCB repair and measurement.
- **Check if the place of installation is at least 2m away from electronic appliances such as TV, video players, and stereos.**
 - This can cause irregular noise or degrade the picture quality.
- **Please make sure the customer does not directly repair the product.**
 - Arbitrary dismantling may result in electric shock or fire.

1-3 Precautions for the Safety

- **Do not pull or touch the power plug or the subsidiary power switch with wet hands.**
 - This may result in electric shock or fire.
- **If the power line or the power plug is damaged, then it must be changed since this is a hazard.**
- **Do not bend the wire too much or position it so that it can be damaged by a heavy object on top.**
 - This may result in electric shock or fire.
- **The use of multiple electric outlets should be prohibited.**
 - This may result in electric shock or fire.
- **Ground the connection if it is necessary.**
 - The connection must be grounded if there is any risk of electrical short due to water or moisture.
- **Unplug the power or turn off the subsidiary power switch when changing or repairing electrical parts.**
 - Doing so will prevent electric shock.
- **Explain to workers that the battery for the remote control needs to be separated for storage purposes when the product will not be used for a long time.**
 - This can cause a problem for the remote control since battery fluid may trickle out.

1-4 Precautions for Handling Refrigerant for Air Conditioner

Environmental Cautions: Air pollution due to gas release

- **Safety Cautions**

If liquid gas is released, then body parts that come into contact with it may experience frostbite/blister/numbness.

If a large amount of gas is released, then suffocation may occur due to lack of oxygen. If the released gas is heated, then noxious gas may be produced by combustion.

- **Container Handling Cautions**

Do not subject container to physical shock or overheating. (Flowage is possible while moving within the regulated pressure.)

1-5 Precautions for Welding the Air Conditioner Pipe

- **Dangerous or flammable objects around the pipe must be removed before the welding.**

- **If the refrigerant is kept inside the product or the pipe, then remove the refrigerant prior to welding.**

If the welding is carried out while the refrigerant is kept inside, the welding cannot be properly performed. This will also produce noxious gas that is a health hazard. This leakage will also explode with the refrigerant and oil due to an increase in the refrigerant pressure, posing a danger to workers.

- **Please remove the oxide produced inside the pipe during the welding with nitrogen gas.**

Using another gas may cause harm to the product or others.

1-6 Precautions for Additional Supplement of Air Conditioner Refrigerant

- **Precisely calculate the refrigerant by using a scale and S-net, and proceed with the test operation.**

Excessive supplement can cause harm to the product since it can cause an inflow of the liquid refrigerant into the compressor.

- **Do not heat the refrigerant container for a forced injection.**

This may cause harm to the product or others since the refrigerant container may burst.

- **Do not operate the product after removing the product safety pressure switch and sensor.**

If the product is blocked inside, then this may cause harm to the product or others due to the excess pressure increase of the refrigerant gas.

1-7 Other Precautions

- **There should be no leakage of the pipes after installation. When withdrawing the refrigerant, the compressor should be stopped before removing the connecting pipe.**

If the compressor is operating while the refrigerant pipe is not correctly connected and the service valve is opened, then air and other substances can enter the pipe. The interior of the refrigerant cycle may then build up excessive high pressure resulting in explosion and damage.

2. Product Specifications

2-1 Product Specifications

2-1-1 Indoor Unit

Model		Europe	AM045NN4DEH/** AM045NN4DEH/**	AM056NN4DEH/** AM056NN4DEH/**	AM071NN4DEH/** AM071NN4DEH/**	AM090NN4DEH/** AM090NN4DEH/**	AM112NN4DEH/** AM112NN4DEH/**	
Power Supply		φ,V,Hz	1,2,220-240,50	1,2,220-240,50	1,2,220-240,50	1,2,220-240,50	1,2,220-240,50	
Mode*1)		-	HP/HR	HP/HR	HP/HR	HP/HR	HP/HR	
Performance	Capacity	Cooling*2)	kW	4.5	5.6	7.1	9.0	11.2
			Btu/h	15,400	19,100	24,200	30,700	38,200
	Heating*3)	kW	5.0	6.3	8.0	10.0	12.5	
		Btu/h	17,100	21,500	27,300	34,100	42,700	
Power	Input Consumption (Cooling/Heating)	W 110% ↓	32.0	32.0	45.0	62.0	78.0	
	Running Current (Cooling/Heating)	A 110% ↓	0.22	0.22	0.31	0.43	0.55	
Sound Level		Sound Pressure*4)	dB(A) ↓	-	-	-	-	
Fan	Type		-	Turbo Fan	Turbo Fan	Turbo Fan	Turbo Fan	
	Motor	Model	-	FMC6531SSH	FMC6531SSH	FMC6531SSH	FMC6531SSH	
		Type	-	BLDC	BLDC	BLDC	BLDC	
		Output	W	65 *5)	65 *5)	65 *5)	65 *5)	
Air Flow Rate	H/M/L (UL)	CMM	14.5/13.5/12.5	15.0/14.0/13.0	17.0/15.5/14.5	19.5/18.0/16.5	26.0/24.0/22.0	
		l/s	242/225/208	250/233/217	283/258/242	325/300/275	433/400/367	
Refrigerant	Type		-	R410A	R410A	R410A	R410A	
	Control Method		-	EEV	EEV	EEV	EEV	
Temperature Control		-	Micom & Thermistors	Micom & Thermistors	Micom & Thermistors	Micom & Thermistors	Micom & Thermistors	
Safety Devices		-	Fuse	Fuse	Fuse	Fuse	Fuse	
Piping Connections	Liquid (Flare)		Φ,mm	6.35	6.35	9.52	9.52	
	Gas (Flare)		Φ,mm	12.7	12.7	15.88	15.88	
	Drain		Φ,mm	VP25 (OD 32,ID 25)	VP25 (OD 32,ID 25)	VP25 (OD 32,ID 25)	VP25 (OD 32,ID 25)	
Weight	Net Weight		kg	15	15	15	16.5	
	Shipping Weight		kg	18.5	18.5	18.5	20.0	
Dimensions	Net Dimensions (W x H x D)		mm	840 x 204 x 840	840 x 204 x 840	840 x 204 x 840	840 x 246 x 840	
	Shipping Dimensions (W x H x D)		mm	898 x 275 x 898	898 x 275 x 898	898 x 275 x 898	898 x 316 x 898	
Panel Size	Model		-	PC4NUFMAN	PC4NUFMAN	PC4NUFMAN	PC4NUFMAN	
	Net Weight		kg	6.3	6.3	6.3	6.3	
	Shipping Weight		kg	8.7	8.7	8.7	8.7	
	Net Dimensions (W x H x D)		mm	950 x 64 x 950	950 x 64 x 950	950 x 64 x 950	950 x 64 x 950	
Shipping Dimensions (W x H x D)		mm	1,010 x 117 x 1,000	1,010 x 117 x 1,000	1,010 x 117 x 1,000	1,010 x 117 x 1,000		
Functions	Auto Restart		-	○	○	○	○	
	Auto Swing		-	○	○	○	○	
	Group/Individual Control		-	○	○	○	○	
	External Contact Control		-	○	○	○	○	
	Trouble Shooting by LED		-	○	○	○	○	
Standard Accessories	Installation Manual		-	○	○	○	○	
	Operation Manual		-	○	○	○	○	
	Pattern Sheet for Installation		-	○	○	○	○	
	Flexible Drain Hose		-	○	○	○	○	
	Filter / Safety Grille		-	Filter / Safety Grille	Filter / Safety Grille	Filter / Safety Grille	Filter / Safety Grille	
	Drain Pump (Pumping speed, lift)		ℓ/h, mm	24, 750	24, 750	24, 750	24, 750	
Optional Accessories	Wireless Remote Controller		-	AR-DH00	AR-DH00	AR-DH00	AR-DH00	
	Wired Remote Controller		-	MWR-WE10N	MWR-WE10N	MWR-WE10N	MWR-WE10N	
	External Contact Interface Module		-	MIM-B14	MIM-B14	MIM-B14	MIM-B14	



*1) Mode

- HP : Heat Pump, HR : Heat Recovery

*2) Nominal cooling capacities are based on;

- Indoor temperature : 27°C DB, 19°C WB

- Outdoor temperature : 35°C DB, 24°C WB, Equivalent refrigerant piping : 7.5m, Level differences : 0m

*3) Nominal heating capacities are based on;

- Indoor temperature : 20°C DB, 15°C WB

- Outdoor temperature : 7°C DB, 6°C WB, Equivalent refrigerant piping : 7.5m, Level differences : 0m

*4) Sound pressure was acquired in a dead room. This actual noise level may be different depending on the installation conditions.

*5) Specifications may be subject to change without prior notice for product improvement.

Indoor Unit (cont.)

Model			Europe	AM128NN4DEH/** AM128NN4DEH/**	AM140NN4DEH/** AM140NN4DEH/**	AM009NN4DCH/**	AM012NN4DCH/**	AM018NN4DCH/**
Power Supply			φ,V,Hz	1,2,220-240,50	1,2,220-240,50	1,2,208-230,60	1,2,208-230,60	1,2,208-230,60
Mode*1)			-	HP/HR	HP/HR	HP/HR	HP/HR	HP/HR
Performance	Capacity	Cooling*2)	kW	12.8	14.0	2.64	3.52	5.28
			Btu/h	43,700	47,800	9,000	12,000	18,000
		Heating*3)	kW	13.8	16.0	2.93	3.96	5.86
			Btu/h	47,100	54,600	10,000	13,500	20,000
Power	Input Consumption (Cooling/Heating)		W 110% ↓	73.0	89.0	32.00	32.00	32.00
	Running Current (Cooling/Heating)		A 110% ↓	0.51	0.62	0.25	0.25	0.25
Sound Level			Sound Pressure*4)	dB(A) ↓	-	-	-	-
Fan	Type		-	Turbo Fan	Turbo Fan	Turbo Fan	Turbo Fan	Turbo Fan
	Motor	Model	-	FMC9731SSB	FMC9731SSB	FMC6531SSH	FMC6531SSH	FMC6531SSH
		Type	-	BLDC	BLDC	BLDC	BLDC	BLDC
		Output	W	97*5)	97*5)	65*5)	65*5)	65*5)
Air Flow Rate	H/M/L (UL)		CMM	28.0/26.0/23.0	30.0/28.0/26.0	15.50 / 14.00 / 12.00	15.50 / 14.00 / 12.00	15.50 / 14.00 / 12.00
			l/s	467/433/383	500/467/433	258/233/200	258/233/200	258/233/200
Refrigerant	Type		-	R410A	R410A	R410A	R410A	R410A
	Control Method		-	EEV	EEV	EEV	EEV	EEV
Temperature Control			-	Micom & Thermistors	Micom & Thermistors	Micom & Thermistors	Micom & Thermistors	Micom & Thermistors
Safety Devices			-	Fuse	Fuse	Fuse	Fuse	Fuse
Piping Connections	Liquid (Flare)		Φ,mm	9.52	9.52	6.35	6.35	6.35
	Gas (Flare)		Φ,mm	15.88	15.88	12.7	12.7	12.7
	Drain		Φ,mm	VP25 (OD 32,ID 25)	VP25 (OD 32,ID 25)	VP25 (OD 32,ID 25)	VP25 (OD 32,ID 25)	VP25 (OD 32,ID 25)
Weight	Net Weight		kg	18.5	18.5	15	15	15
	Shipping Weight		kg	22.5	22.5	18.5	18.5	18.5
Dimensions	Net Dimensions (W x H x D)		mm	840 x 288 x 840	840 x 288 x 840	840 x 204 x 840	840 x 204 x 840	840 x 204 x 840
	Shipping Dimensions (W x H x D)		mm	898 x 357 x 898	898 x 357 x 898	898 x 275 x 898	898 x 275 x 898	898 x 275 x 898
Panel Size	Model		-	PC4NUFMAN	PC4NUFMAN	PC4NUFMAN	PC4NUFMAN	PC4NUFMAN
	Net Weight		kg	6.3	6.3	6.3	6.3	6.3
	Shipping Weight		kg	8.7	8.7	8.7	8.7	8.7
	Net Dimensions (W x H x D)		mm	950 x 64 x 950	950 x 64 x 950	950 x 64 x 950	950 x 64 x 950	950 x 64 x 950
	Shipping Dimensions (W x H x D)		mm	1,010 x 117 x 1,000	1,010 x 117 x 1,000	1,010 x 117 x 1,000	1,010 x 117 x 1,000	1,010 x 117 x 1,000
Functions	Auto Restart		-	0	0	0	0	0
	Auto Swing		-	0	0	0	0	0
	Group/Individual Control		-	0	0	0	0	0
	External Contact Control		-	0	0	0	0	0
	Trouble Shooting by LED		-	0	0	0	0	0
Standard Accessories	Installation Manual		-	0	0	0	0	0
	Operation Manual		-	0	0	0	0	0
	Pattern Sheet for Installation		-	0	0	0	0	0
	Flexible Drain Hose		-	0	0	0	0	0
	Filter / Safety Grille		-	Filter / Safety Grille	Filter / Safety Grille	Filter / Safety Grille	Filter / Safety Grille	Filter / Safety Grille
	Drain Pump (Pumping speed, lift)		ℓ/h, mm	24, 750	24, 750	24, 750	24, 750	24, 750
Optional Accessories	Wireless Remote Controller		-	AR-DH00	AR-DH00	AR-EH03E	AR-EH03E	AR-EH03E
	Wired Remote Controller		-	MWR-WE10N	MWR-WE10N	MWR-WE13N	MWR-WE13N	MWR-WE13N
	External Contact Interface Module		-	MIM-B14	MIM-B14	MIM-B14	MIM-B14	MIM-B14



- *1) Mode
 - HP : Heat Pump, HR : Heat Recovery
- *2) Nominal cooling capacities are based on;
 - Indoor temperature : 27°C DB, 19°C WB
 - Outdoor temperature : 35°C DB, 24°C WB, Equivalent refrigerant piping : 7.5m, Level differences : 0m
- *3) Nominal heating capacities are based on;
 - Indoor temperature : 20°C DB, 15°C WB
 - Outdoor temperature : 7°C DB, 6°C WB, Equivalent refrigerant piping : 7.5m, Level differences : 0m
- *4) Sound pressure was acquired in a dead room. This actual noise level may be different depending on the installation conditions.
- *5) Specifications may be subject to change without prior notice for product improvement.

Indoor Unit (cont.)

Model			Europe	AM024NN4DCH/**	AM030NN4DCH/**	AM036NN4DCH/**	AM048NN4DCH/**	AM005NNNDCH/**
Power Supply			φ,V,Hz	1,2,208-230,60	1,2,208-230,60	1,2,208-230,60	1,2,208-230,60	1,2,208-230,60
Mode*1)			-	HP/HR	HP/HR	HP/HR	HP/HR	HP/HR
Performance	Capacity	Cooling*2)	kW	7.03	8.79	10.55	14.07	1.47
			Btu/h	24,000	30,000	36,000	48,000	5,000
		Heating*3)	kW	7.91	9.96	11.72	15.83	1.76
			Btu/h	27,000	34,000	40,000	54,000	6,000
Power	Input Consumption (Cooling/Heating)		W 110% ↓	40.00	65.00	75.00	95.00	18
	Running Current (Cooling/Heating)		A 110% ↓	0.30	0.50	0.56	0.75	0.19
Sound Level			Sound Pressure*4)	dB(A) ↓	-	-	-	-
Fan	Type		-	Turbo Fan	Turbo Fan	Turbo Fan	Turbo Fan	Turbo Fan
	Motor	Model	-	FMC6531SSH	FMC9731SSB	FMC9731SSB	FMC9731SSB	FMC6531SSJ
		Type	-	BLDC	BLDC	BLDC	BLDC	BLDC
		Output	W	65 *5)	97 *5)	97 *5)	97 *5)	65 *5)
Air Flow Rate	H/M/L (UL)		CMM	17.50 / 16.00 / 14.00	22.00 / 19.50 / 17.00	24.00 / 22.00 / 20.00	29.00 / 27.00 / 24.00	8.50 / 7.20 / 6.50
			l/s	291/266/233	367/235/283	400/367/333	483/450/400	142/120/108
Refrigerant	Type		-	R410A	R410A	R410A	R410A	R410A
	Control Method		-	EEV	EEV	EEV	EEV	EEV
Temperature Control			-	Micom & Thermistors	Micom & Thermistors	Micom & Thermistors	Micom & Thermistors	Micom & Thermistors
Safety Devices			-	Fuse	Fuse	Fuse	Fuse	Fuse
Piping Connections	Liquid (Flare)		Φ,mm	9.52	9.52	9.52	9.52	6.35
	Gas (Flare)		Φ,mm	15.88	15.88	15.88	15.88	12.7
	Drain		Φ,mm	VP25 (OD 32,ID 25)	VP25 (OD 32,ID 25)	VP25 (OD 32,ID 25)	VP25 (OD 32,ID 25)	VP25 (OD 32,ID 25)
Weight	Net Weight		kg	15	18.5	18.5	18.5	11.7
	Shipping Weight		kg	18.5	23.0	23.0	23.0	13.7
Dimensions	Net Dimensions (W x H x D)		mm	840 x 204 x 840	840 x 288 x 840	840 x 288 x 840	840 x 288 x 840	575 x 250 x 575
	Shipping Dimensions (W x H x D)		mm	898 x 275 x 898	898 x 357 x 898	898 x 357 x 898	898 x 357 x 898	623 x 298 x 653
Panel Size	Model		-	PC4NUFMAN	PC4NUFMAN	PC4NUFMAN	PC4NUFMAN	PC4SUFMAN
	Net Weight		kg	6.3	6.3	6.3	6.3	2.7
	Shipping Weight		kg	8.7	8.7	8.7	8.7	3.9
	Net Dimensions (W x H x D)		mm	950 x 64 x 950	950 x 64 x 950	950 x 64 x 950	950 x 64 x 950	620 x 57 x 620
	Shipping Dimensions (W x H x D)		mm	1,010 x 117 x 1,000	1,010 x 117 x 1,000	1,010 x 117 x 1,000	1,010 x 117 x 1,000	670 x 120 x 655
Functions	Auto Restart		-	0	0	0	0	0
	Auto Swing		-	0	0	0	0	0
	Group/Individual Control		-	0	0	0	0	0
	External Contact Control		-	0	0	0	0	0
	Trouble Shooting by LED		-	0	0	0	0	0
Standard Accessories	Installation Manual		-	0	0	0	0	0
	Operation Manual		-	0	0	0	0	0
	Pattern Sheet for Installation		-	0	0	0	0	0
	Flexible Drain Hose		-	0	0	0	0	0
	Filter / Safety Grille		-	Filter / Safety Grille	Filter / Safety Grille	Filter / Safety Grille	Filter / Safety Grille	Filter / Safety Grille
	Drain Pump (Pumping speed, lift)		ℓ/h, mm	24, 750	24, 750	24, 750	24, 750	24, 750
Optional Accessories	Wireless Remote Controller		-	AR-EH03E	AR-EH03E	AR-EH03E	AR-EH03E	AR-EH03E
	Wired Remote Controller		-	MWR-WE13N	MWR-WE13N	MWR-WE13N	MWR-WE13N	MWR-WE13N
	External Contact Interface Module		-	MIM-B14	MIM-B14	MIM-B14	MIM-B14	MIM-B14



*1) Mode

- HP : Heat Pump, HR : Heat Recovery

*2) Nominal cooling capacities are based on;

- Indoor temperature : 27°C DB, 19°C WB

- Outdoor temperature : 35°C DB, 24°C WB, Equivalent refrigerant piping : 7.5m, Level differences : 0m

*3) Nominal heating capacities are based on;

- Indoor temperature : 20°C DB, 15°C WB

- Outdoor temperature : 7°C DB, 6°C WB, Equivalent refrigerant piping : 7.5m, Level differences : 0m

*4) Sound pressure was acquired in a dead room. This actual noise level may be different depending on the installation conditions.

*5) Specifications may be subject to change without prior notice for product improvement.

Indoor Unit (cont.)

Model		Europe	AM007NNNDCH/**	AM009NNNDCH/**	AM012NNNDCH/**	AM018NNNDCH/**	AM020NNNDCH/**	
Power Supply		φ,V,Hz	1,2,208-230,60	1,2,208-230,60	1,2,208-230,60	1,2,208-230,60	1,2,208-230,60	
Mode*1)		-	HP/HR	HP/HR	HP/HR	HP/HR	HP/HR	
Performance	Capacity	Cooling*2)	kW	2.20	2.78	3.52	5.28	5.86
			Btu/h	7,500	9,500	12,000	18,000	20,000
	Heating*3)	kW	2.55	3.08	3.96	5.86	6.74	
		Btu/h	8,700	10,500	13,500	20,000	23,000	
Power	Input Consumption (Cooling/Heating)		W 110% ↓	20	20	23	28	31
	Running Current (Cooling/Heating)		A 110% ↓	0.19	0.19	0.22	0.27	0.3
Sound Level		Sound Pressure*4)		dB(A) ↓	-	-	-	-
Fan	Type		-	Turbo Fan	Turbo Fan	Turbo Fan	Turbo Fan	Turbo Fan
	Motor	Model	-	FMC6531SSJ	FMC6531SSJ	FMC6531SSJ	FMC6531SSJ	FMC6531SSJ
		Type	-	BLDC	BLDC	BLDC	BLDC	BLDC
		Output	W	65 *5)	65 *5)	65 *5)	65 *5)	65 *5)
Air Flow Rate	H/M/L (UL)		CMM	9.00/7.70/6.50	10.00/8.50/7.50	10.50/9.50/8.00	13.00/11.00/9.50	13.50/12.00/10.20
			l/s	150/128/108	167/142/125	175/158/133	217/183/158	225/200/170
Refrigerant	Type		-	R410A	R410A	R410A	R410A	R410A
	Control Method		-	EEV	EEV	EEV	EEV	EEV
Temperature Control		-	Micom & Thermistors	Micom & Thermistors	Micom & Thermistors	Micom & Thermistors	Micom & Thermistors	
Safety Devices		-	Fuse	Fuse	Fuse	Fuse	Fuse	
Piping Connections	Liquid (Flare)		Φ,mm	6.35	6.35	6.35	6.35	6.35
	Gas (Flare)		Φ,mm	12.7	12.7	12.7	12.7	12.7
	Drain		Φ,mm	VP25 (OD 32,ID 25)	VP25 (OD 32,ID 25)	VP25 (OD 32,ID 25)	VP25 (OD 32,ID 25)	VP25 (OD 32,ID 25)
Weight	Net Weight		kg	12.0	12.0	12.0	12.0	12.0
	Shipping Weight		kg	14.0	14.0	14.0	14.0	14.0
Dimensions	Net Dimensions (W x H x D)		mm	575 x 250 x 575	575 x 250 x 575	575 x 250 x 575	575 x 250 x 575	575 x 250 x 575
	Shipping Dimensions (W x H x D)		mm	623 x 298 x 653	623 x 298 x 653	623 x 298 x 653	623 x 298 x 653	623 x 298 x 653
Panel Size	Model		-	PC4SUFMAN	PC4SUFMAN	PC4SUFMAN	PC4SUFMAN	PC4SUFMAN
	Net Weight		kg	2.7	2.7	2.7	2.7	2.7
	Shipping Weight		kg	3.9	3.9	3.9	3.9	3.9
	Net Dimensions (W x H x D)		mm	620 x 57 x 620	620 x 57 x 620	620 x 57 x 620	620 x 57 x 620	620 x 57 x 620
	Shipping Dimensions (W x H x D)		mm	670 x 120 x 655	670 x 120 x 655	670 x 120 x 655	670 x 120 x 655	670 x 120 x 655
Functions	Auto Restart		-	0	0	0	0	0
	Auto Swing		-	0	0	0	0	0
	Group/Individual Control		-	0	0	0	0	0
	External Contact Control		-	0	0	0	0	0
	Trouble Shooting by LED		-	0	0	0	0	0
Standard Accessories	Installation Manual		-	0	0	0	0	0
	Operation Manual		-	0	0	0	0	0
	Pattern Sheet for Installation		-	0	0	0	0	0
	Flexible Drain Hose		-	0	0	0	0	0
	Filter / Safety Grille		-	Filter / Safety Grille	Filter / Safety Grille	Filter / Safety Grille	Filter / Safety Grille	Filter / Safety Grille
	Drain Pump (Pumping speed, lift)		ℓ/h, mm	24, 750	24, 750	24, 750	24, 750	24, 750
Optional Accessories	Wireless Remote Controller		-	AR-EH03E	AR-EH03E	AR-EH03E	AR-EH03E	AR-EH03E
	Wired Remote Controller		-	MWR-WE13N	MWR-WE13N	MWR-WE13N	MWR-WE13N	MWR-WE13N
	External Contact Interface Module		-	MIM-B14	MIM-B14	MIM-B14	MIM-B14	MIM-B14



- *1) Mode
 - HP : Heat Pump, HR : Heat Recovery
- *2) Nominal cooling capacities are based on;
 - Indoor temperature : 27°C DB, 19°C WB
 - Outdoor temperature : 35°C DB, 24°C WB, Equivalent refrigerant piping : 7.5m, Level differences : 0m
- *3) Nominal heating capacities are based on;
 - Indoor temperature : 20°C DB, 15°C WB
 - Outdoor temperature : 7°C DB, 6°C WB, Equivalent refrigerant piping : 7.5m, Level differences : 0m
- *4) Sound pressure was acquired in a dead room. This actual noise level may be different depending on the installation conditions.
- *5) Specifications may be subject to change without prior notice for product improvement.

Indoor Unit (cont.)

Model		Europe	AM015NNNDEH/** AM015NNNDEH/**	AM022NNNDEH/** AM022NNNDEH/**	AM028NNNDEH/** AM028NNNDEH/**	AM036NNNDEH/** AM036NNNDEH/**	AM045NNNDEH/** AM045NNNDEH/**	
Power Supply		φ,V,Hz	1,2,220-240,50	1,2,220-240,50	1,2,220-240,50	1,2,220-240,50	1,2,220-240,50	
Mode*1)		-	HP/HR	HP/HR	HP/HR	HP/HR	HP/HR	
Performance	Capacity	Cooling*2)	kW	1.5	2.2	2.8	3.6	4.5
			Btu/h	5,100	7,500	9,600	12,300	15,400
	Heating*3)	kW	1.7	2.5	3.2	4.0	5.0	
		Btu/h	8,500	8,500	10,900	13,600	17,100	
Power	Input Consumption (Cooling/Heating)		W 110% ↓	18.0	18.0	18.0	20.0	23.0
	Running Current (Cooling/Heating)		A 110% ↓	0.17	0.17	0.17	0.19	0.22
Sound Level		Sound Pressure*4)	dB(A) ↓	-	-	-	-	-
Fan	Type		-	Turbo Fan	Turbo Fan	Turbo Fan	Turbo Fan	Turbo Fan
	Motor	Model	-	FMC6531SSJ	FMC6531SSJ	FMC6531SSJ	FMC6531SSJ	FMC6531SSJ
		Type	-	BLDC	BLDC	BLDC	BLDC	BLDC
		Output	W	65 *5)	65 *5)	65 *5)	65 *5)	65 *5)
Air Flow Rate	H/M/L (UL)		CMM	8.50/7.20/6.50	9.00/7.70/6.50	10.00/8.50/7.50	10.50/9.00/7.50	11.50/10.20/9.00
			l/s	142/120/108	150/128/108	167/142/125	175/150/125	192/170/150
Refrigerant	Type		-	R410A	R410A	R410A	R410A	R410A
	Control Method		-	EEV	EEV	EEV	EEV	EEV
Temperature Control		-	Micom & Thermistors	Micom & Thermistors	Micom & Thermistors	Micom & Thermistors	Micom & Thermistors	
Safety Devices		-	Fuse	Fuse	Fuse	Fuse	Fuse	
Piping Connections	Liquid (Flare)		Φ,mm	6.35	6.35	6.35	6.35	6.35
	Gas (Flare)		Φ,mm	12.7	12.7	12.7	12.7	12.7
	Drain		Φ,mm	VP25 (OD 32,ID 25)	VP25 (OD 32,ID 25)	VP25 (OD 32,ID 25)	VP25 (OD 32,ID 25)	VP25 (OD 32,ID 25)
Weight	Net Weight		kg	11.7	12.0	12.0	12.0	12.0
	Shipping Weight		kg	13.7	14	14	14	14
Dimensions	Net Dimensions (W x H x D)		mm	575 x 250 x 575	575 x 250 x 575	575 x 250 x 575	575 x 250 x 575	575 x 250 x 575
	Shipping Dimensions (W x H x D)		mm	623 x 298 x 653	623 x 298 x 653	623 x 298 x 653	623 x 298 x 653	623 x 298 x 653
Panel Size	Model		-	PC4SUFMAN	PC4SUFMAN	PC4SUFMAN	PC4SUFMAN	PC4SUFMAN
	Net Weight		kg	2.7	2.7	2.7	2.7	2.7
	Shipping Weight		kg	3.9	3.9	3.9	3.9	3.9
	Net Dimensions (W x H x D)		mm	620 x 57 x 620	620 x 57 x 620	620 x 57 x 620	620 x 57 x 620	620 x 57 x 620
	Shipping Dimensions (W x H x D)		mm	670 x 120 x 655	670 x 120 x 655	670 x 120 x 655	670 x 120 x 655	670 x 120 x 655
Functions	Auto Restart		-	0	0	0	0	0
	Auto Swing		-	0	0	0	0	0
	Group/Individual Control		-	0	0	0	0	0
	External Contact Control		-	0	0	0	0	0
	Trouble Shooting by LED		-	0	0	0	0	0
Standard Accessories	Installation Manual		-	0	0	0	0	0
	Operation Manual		-	0	0	0	0	0
	Pattern Sheet for Installation		-	0	0	0	0	0
	Flexible Drain Hose		-	0	0	0	0	0
	Filter / Safety Grille		-	Filter / Safety Grille	Filter / Safety Grille	Filter / Safety Grille	Filter / Safety Grille	Filter / Safety Grille
	Drain Pump (Pumping speed, lift)		ℓ/h, mm	24, 750	24, 750	24, 750	24, 750	24, 750
	Wireless Remote Controller		-	AR-DH00	AR-DH00	AR-DH00	AR-DH00	AR-DH00
Optional Accessories	Wired Remote Controller		-	MWR-WE10N	MWR-WE10N	MWR-WE10N	MWR-WE10N	MWR-WE10N
	External Contact Interface Module		-	MIM-B14	MIM-B14	MIM-B14	MIM-B14	MIM-B14



*1) Mode

- HP : Heat Pump, HR : Heat Recovery

*2) Nominal cooling capacities are based on;

- Indoor temperature : 27°C DB, 19°C WB

- Outdoor temperature : 35°C DB, 24°C WB, Equivalent refrigerant piping : 7.5m, Level differences : 0m

*3) Nominal heating capacities are based on;

- Indoor temperature : 20°C DB, 15°C WB

- Outdoor temperature : 7°C DB, 6°C WB, Equivalent refrigerant piping : 7.5m, Level differences : 0m

*4) Sound pressure was acquired in a dead room. This actual noise level may be different depending on the installation conditions.

*5) Specifications may be subject to change without prior notice for product improvement.

Indoor Unit (cont.)





















Model		Europe	AM056NNNDEH/** AM056NNNDEH/**	AM060NNNDEH/** AM060NNNDEH/**	
Power Supply		φ,V,Hz	1,2,220-240,50	1,2,220-240,50	
Mode*1)		-	HP/HR	HP/HR	
Performance	Capacity	Cooling*2)	kW	5.6	6.0
			Btu/h	19,100	20,500
	Heating*3)	kW	6.3	6.8	
		Btu/h	21,500	23,200	
Power	Input Consumption (Cooling/Heating)		W 110% ↓	28.0	31.0
	Running Current (Cooling/Heating)		A 110% ↓	0.27	0.30
Sound Level		Sound Pressure*4)	dB(A) ↓	-	-
Fan	Type		-	Turbo Fan	Turbo Fan
	Motor	Model	-	FMC6531SSJ	FMC6531SSJ
		Type	-	BLDC	BLDC
		Output	W	65 *5)	65 *5)
Air Flow Rate	H/M/L (UL)		CMM	13.00/11.00/9.50	13.50/12.00/10.20
			l/s	217/183/158	225/200/170
Refrigerant	Type		-	R410A	R410A
	Control Method		-	EEV	EEV
Temperature Control		-	Micom & Thermistors	Micom & Thermistors	
Safety Devices		-	Fuse	Fuse	
Piping Connections	Liquid (Flare)		Φ,mm	6.35	6.35
	Gas (Flare)		Φ,mm	12.7	12.7
	Drain		Φ,mm	VP25 (OD 32,ID 25)	VP25 (OD 32,ID 25)
Weight	Net Weight		kg	12.0	12.0
	Shipping Weight		kg	14	14
Dimensions	Net Dimensions (W x H x D)		mm	575 x 250 x 575	575 x 250 x 575
	Shipping Dimensions (W x H x D)		mm	623 x 298 x 653	623 x 298 x 653
Panel Size	Model		-	PC4SUFMAN	PC4SUFMAN
	Net Weight		kg	2.7	2.7
	Shipping Weight		kg	3.9	3.9
	Net Dimensions (W x H x D)		mm	620 x 57 x 620	620 x 57 x 620
	Shipping Dimensions (W x H x D)		mm	670 x 120 x 655	670 x 120 x 655
Functions	Auto Restart		-	0	0
	Auto Swing		-	0	0
	Group/Individual Control		-	0	0
	External Contact Control		-	0	0
	Trouble Shooting by LED		-	0	0
Standard Accessories	Installation Manual		-	0	0
	Operation Manual		-	0	0
	Pattern Sheet for Installation		-	0	0
	Flexible Drain Hose		-	0	0
	Filter / Safety Grille		-	Filter / Safety Grille	Filter / Safety Grille
	Drain Pump (Pumping speed, lift)		ℓ/h, mm	24, 750	24, 750
Optional Accessories	Wireless Remote Controller		-	AR-DH00	AR-DH00
	Wired Remote Controller		-	MWR-WE10N	MWR-WE10N
	External Contact Interface Module		-	MIM-B14	MIM-B14











- *1) Mode
 - HP : Heat Pump, HR : Heat Recovery
- *2) Nominal cooling capacities are based on;
 - Indoor temperature : 27°C DB, 19°C WB
 - Outdoor temperature : 35°C DB, 24°C WB, Equivalent refrigerant piping : 7.5m, Level differences : 0m
- *3) Nominal heating capacities are based on;
 - Indoor temperature : 20°C DB, 15°C WB
 - Outdoor temperature : 7°C DB, 6°C WB, Equivalent refrigerant piping : 7.5m, Level differences : 0m
- *4) Sound pressure was acquired in a dead room. This actual noise level may be different depending on the installation conditions.
- *5) Specifications may be subject to change without prior notice for product improvement.

















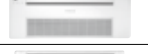

2-2 Accessory and Option Specifications

2-2-1 Accessories

Classification		Product	Model	Image	Application model
Integrated management system	Controller	DMS 2	MIM-D00AN		DVM Series, FJM, CAC, ERV Hydro unit, Hydro unit HT
		S-NET 3	MST-P3P		DVM Series, FJM, CAC, ERV Hydro unit, Hydro unit HT
	Interface Module	SIM MIM-	MIM-B12N		DVM Series, FJM
Centralized control system	Controller	Centralized controller	MCM-A202DN		DVM Series, FJM, CAC, ERV Hydro unit, Hydro unit HT
		Operation mode selection switch	MCM-C200		DVM Series (Except HR models)
		New touch CONTROLLER	MCM-A300N		
Individual control system ControllerController	Controller	Wireless remote controller	MR-DH00		Cassette, Duct (Receiver needed)
			MR-EH00		Cassette, Duct (Receiver needed)
			MR-KH00		360 cassette
			AR-EH03E		All model
		Wired remote controller (Multi function)	MWR-WE10N		Cassette, Wall-mounted, Ceiling, Duct, Console, ERV
			MWR-WE13N		All model
		Wired remote controller (Multi function)	MWR-WW00N		Hydro unit / Hydro unit HT
		Wireless signal receiver	MRK-A10		Duct (For wireless remote controller)
		Remote sensor	MRW-TA		Cassette, Wall-mounted, Ceiling, Duct, Console
		ERV CO2 Sensor	MOS-C1		ERV, ERV PLUS
Building management system	Lonworks interface module	MIM-B18N		DVM Series, FJM, CAC, ERV	
	DMS-Bnet (BACnet)	MIM-B17N		DVM Series, FJM Hydro unit, Hydro unit HT	
Guest room management system	External contact interface module	MIM-B14		Mini DVM(R-410A), DVM PLUS III, FJM	
Power distribution			MIM-B16N		DVM Series, FJM
Converter			MIM-C02N		DVM Series, FJM, CAC
			MIM-N00		
Multi Tenant Function Controller			MCM-C210		







※ DVM Series : DVM mini, DVM PLUS III, DVM PLUS III HR, DVM PLUS IV, DVM PLUS IV HR

Classification	Feature	Model	Description	Relevant unit	Remark	
Y-JOINT		MXJ-YA1509M	15.0 kW and below	DVMS HP / HR	Requisite	
		MXJ-YA2512M	Over 15.0 ~ 40.6 kW and below			
		MXJ-YA2812M	Over 40.6 ~ 46.4 kW and below			
		MXJ-YA2815M	Over 46.4 ~ 69.6 kW and below			
		MXJ-YA3419M	Over 69.6 ~ 98.6 kW and below			
		MXJ-YA4119M	Over 98.6 ~ 139.2 kW and below			
		MXJ-YA4422M	Over 139.2 kW			
Y-joint(High Pressure Gas) for DVM S HR		MXJ-YA1500M	23.2 kW and below	DVMS HR	Requisite	
		MXJ-YA2500M	Over 23.2 ~ 69.6 kW and below			
		MXJ-YA3100M	Over 69.6 ~ 139.2 kW and below			
		MXJ-YA3800M	Over 139.2 kW			
Outdoor joint (Outdoor Connection)		MXJ-TA3819M	Below 48 HP	DVMS HP / HR	Requisite	
		MXJ-TA4422M	Over 50 HP			
Outdoor joint (High Pressure Gas) for DVM S HR		MXJ-TA3100M	Below 48 HP	DVMS HR	Requisite	
		MXJ-TA3800M	Over 50 HP			
Header joint		MXJ-HA2512M	Below 46.4 kW	DVMS HP / HR	Requisite	
		MXJ-HA3115M	Below 69.6 kW			
		MXJ-HA3819M	Over 69.7 kW			
EEV kits		MXD-E13K116A	Below 3.6 kW (1 Room) + 5.6 kW ~9.0 kW (1Room)	Wall-mounted & Ceiling indoor unit (For 2 indoor units)	Option	
		MXD-E13K200A	Below 3.6 kW (2 Rooms)			
		MXD-E16K200A	5.6 kW~9.0 kW (2Rooms)			
		MXD-E22K200A	Over 9.0 kW (2Rooms)			
		MXD-E13K216A	Below 3.6 kW (2 Rooms) + 5.6 kW ~9.0 kW (1Room)	Wall-mounted & Ceiling indoor unit (For 3 indoor units)		
		MXD-E13K300A	Below 3.6 kW (3 Rooms)			
		MXD-E16K213A	Below 3.6 kW (1 Room) + 5.6 kW ~9.0 kW (2Rooms)			
		MXD-E16K300A	5.6 kW ~ 9.0 kW (3Rooms)	Wall-mounted & Ceiling indoor unit (for single unit)		
		MEV-E13SA	Below 3.6 kW (1 Room)			
		MEV-E16SA	5.6 kW ~ 9.0 kW (1Room)			
Drain Pump		MDP-N047SNC1D	HSP Duct 22.0/28.0kW	-	Option	
			MDP-M075SGU1D	MSP Duct (9.0/11.2) kW		-
			MDP-M075SGU2D	MSP Duct (12.8/14.0) kW HSP Duct (11.2/12.8/14.0) kW		
	MDP-M075SGU3D		MSP Duct (5.6/7.1) kW			
		MDP-E075SEE3D	SlimDuct (1.7~14.0) kW	-		
		MDP-G075SQ (Internal installation)	Global Duct GD-S Big Duct	-		
		MDP-G075SP (External installation)		-		

Classification	Feature	Model	Description	Relevant unit	Remark
MCU		MCU-S4NEE1N	Below 4 indoor units	DVMS HR	Requisite (HR Only)
		MCU-S6NEE1N	Below 2 large capacity ducts		
		MCU-S4NEE2N	Below 6 indoor units		
AHU KIT		MXD-K025AN	7.0kW~8.75kW	-	Option
		MXD-K050AN	14.0kW~17.5kW		
		MXD-K075AN	21.0kW~26.25kW		
		MXD-K100AN	28.0kW~35.0kW		
PDM KIT		MXD-A38K2A	8~12HP	DVMS	Option
		MXD-A58K2A	14~22HP		
Humidifier		MVO-VA050100	500CMH	-	Option
		MVO-VA100100	1000CMH		
S-Plasma Ion KIT		MSD-CAN1	4way Cassette	-	Option
		MSD-EAN1	ERV-Plus		
Motion detect sensor		MCR-SMA	4way Cassette	-	Option
Front panel		PC1MWSKAN	Slim 1way cassette	-	Requisite
		PC1NWSMAN	Slim 1way cassette		
		PC1BWSMAN	Slim 1way cassette		
		PC1MWFMAN	Wind-free 1way cassette		
		PC1NWFMAN			
		PC1BWFMAN			
		PC1NUSMAN	Slim 1way cassette		
		PC1NUPMAN	Slim 1way cassette		
		PC2NUSMEN	2 way cassette		
		PC4SUSMAN	Mini 4way cassette		
		PC4SYSMEN	Mini 4way cassette		
		PC4NUSKAN	4 way cassette		
		PC4NUSKEN	4 way cassette		
		PC4NBSKAN	4 way cassette		
	PC4NUDMAN	360 cassette			
	PC4NUNMAN	360 cassette			



3. Disassembly and Reassembly





■ Necessary Tools

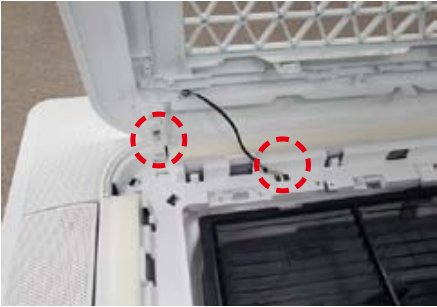
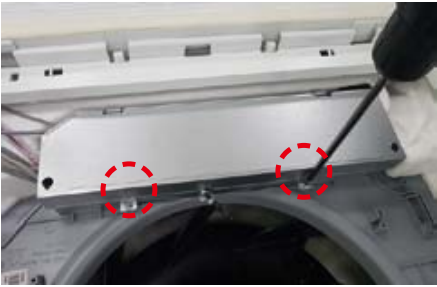
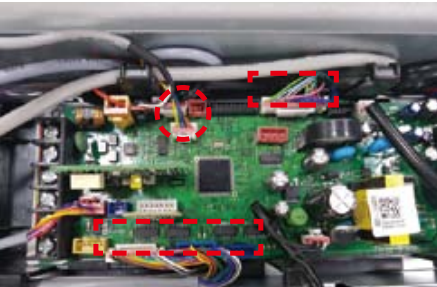

Item	Remark
+Screw Driver	
Monkey Spanner	
-Screw Driver	
Nipper	
Electric Motion Driver	
L-Wrench	

3-1 Indoor Unit

■ AM045/056/071/090/112/128/140NN4DEH/**
AM009/012/018/024/036/048NN4DCH/**

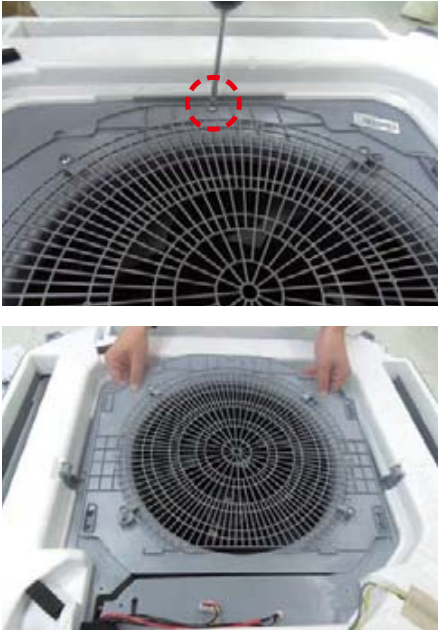

No	Parts	Procedure	Remark
1	Panel	<ol style="list-style-type: none"> 1) Pull two levers below Samsung logo to open the grille. 2) Detach the safety clip and white link from the panel. 3) Remove the 2 fixed screws to remove the Control-Box Cover.(Use +Screw Driver) 4) Remove the 4 connector wires from the PBA. (Remocon-Receiver, Blade motor and Humidity sensor.) 5) Detach the 4 corners of the panel using both hands. 	    

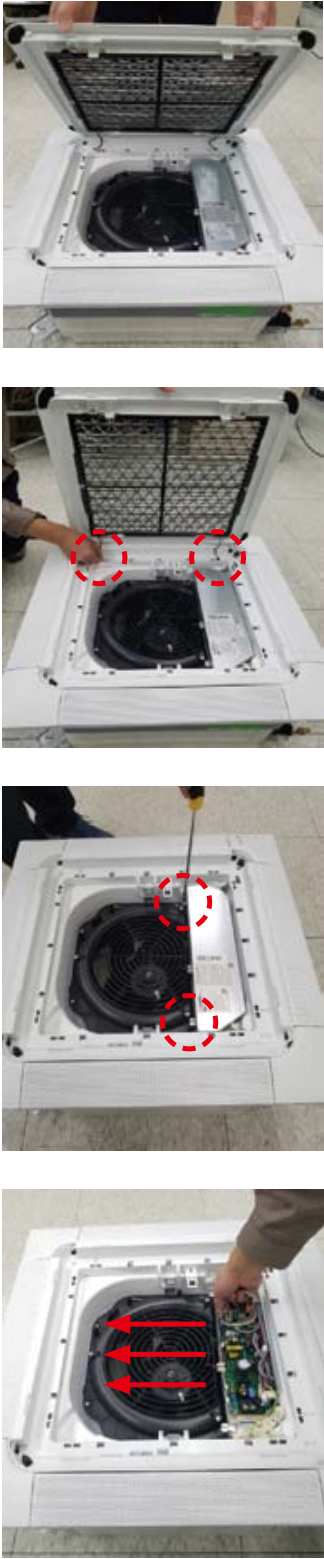

No	Parts	Procedure	Remark
		<p>6) RDisassemble the bolts that are assembled with the indoor unit at the 4 panel corners.</p> <p>7) PPress the Steel Hangers at both sides of the panel inwards, and rotate them 90 degrees to remove it from the indoor unit's Hock. Remove the panel from the indoor unit.</p>	 
2	Control-Box	<p>1) Disconnect the Connector Wire that is connected to the indoor unit's PBA from the PBA.</p> <p>2) Unscrew the 2 fixed screws on both sides of the Control Box, and disassemble the Control Box from the indoor unit. (Use +Screw Driver)</p>	  

No	Parts	Procedure	Remark
3	Bell-Mouth	<p>1) Unscrew the screw fixed on the Bell-Mouth. (Use +Screw Driver)</p> <p>2) Push the Bell-Mouth in the direction opposite to where it's installed on the Control-Box to remove it.</p>	
4	Drain Pan	<p>1) Unscrew the screws on the 4 corners of the indoor unit. (Use +Screw Driver)</p> <p>2) Remove the Drain Pan from the indoor unit.</p>	

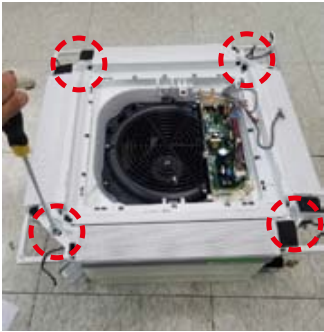
■ AM015/022/028/036/045/056/060NNNDEH/**
AM005/007/009/012/018/020NNNDCH/**

No	Parts	Procedure	Remark
1	Panel	<p>1) Pull both hooks and take the grille downward. Two safety clips are mounted to the front grille to prevent it from dropping.</p> <p>2) Detach the safety clip and take up the grille.</p> <p>3) Remove the 2 fixed screws to remove the Control-Box Cover. (Use +Screw Driver)</p> <p>4) Remove the Remocon-Receiver and Blade Connector Wire from the PBA. (3EA)</p>	 <p>The 'Remark' column contains four sequential photographs illustrating the disassembly process. The first photo shows the top grille being pulled down. The second photo shows two safety clips being detached from the grille, indicated by red dashed circles. The third photo shows a screwdriver being used to remove two screws from the control box cover, also indicated by red dashed circles. The fourth photo shows the removal of three components from the PBA, indicated by three red arrows pointing to the components.</p>

No	Parts	Procedure	Remark
1	Panel	<p>5) Push the 4 panel corners and cover downwards to remove it.</p> <p>6) Disassemble the bolts that are assembled with the indoor unit at the 4 panel corners.</p> <p>7) Press the Hangers at both sides of the panel inwards, to remove it from the indoor unit's hook. Remove the panel from the indoor unit.</p>	  
2	Control-Box	<p>1) Disconnect the Connector Wire that is connected to the indoor unit's PBA.</p>	

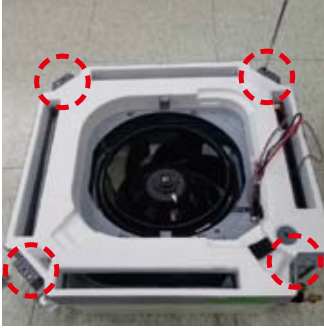
No	Parts	Procedure	Remark
2	Control-Box	2) Unscrew the 2 fixed screws on both sides of the Control Box, and disassemble the Control Box from the indoor unit. (Use +Screw Driver)	
3	Bell-Mouth	<p>1) Unscrew the screw fixed on the Bell-Mouth. (Use +Screw Driver)</p> <p>1) Push the Bell-Mouth in the direction opposite to where it's installed on the Control-Box to remove it.</p>	 
4	Drain Pan	1) Unscrew the screws on the 4 corners of the indoor unit. (Use +Screw Driver)	

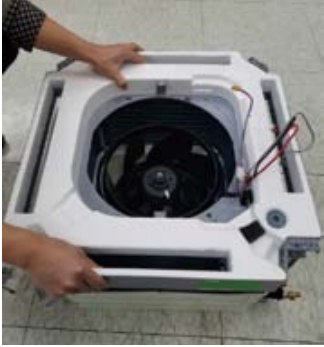
No	Parts	Procedure	Remark
4	Drain Pan	1) Remove the Drain Pan from the indoor unit.	

4. Troubleshooting

4-1 Check-up Window Description

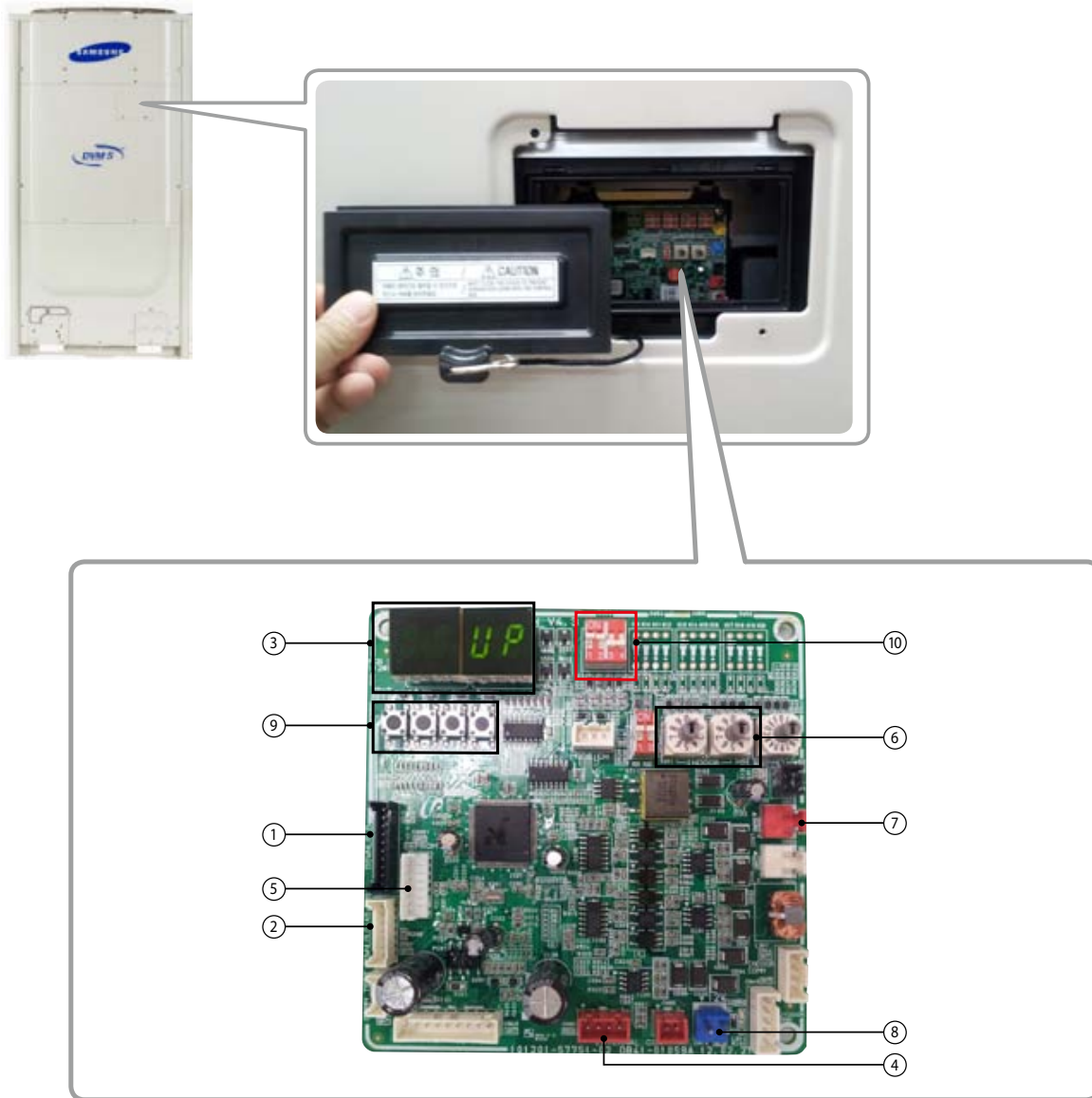

No.	Function	No.	Function
1	CN22 download (PC) (SMW200-10 black)	6	Set up the number of connected outdoor units
2	MICOM. download (AS-PRO) (SMW200-07P white)	7	For checking indoor unit communication (YW396-02P red)
3	ERROR DISPLAY	8	Transmitter 12V (YW396-02P blue)
4	State Check (SMW250-04P red)	9	Outdoor Unit Tact Switch
5	EEPROM SOCKET	10	Outdoor Unit Dip Switch

4-2 Service Operation

4-2-1 Special Operation

- ▶ Key input of the outdoor unit when the service enters the operation mode.

K1 (Number of press)	Key operation	Display on segment
1 time	Refrigerant charging in Heating mode	K, 1, BLANK, BLANK
2 times	Trial operation in Heating mode	K, 2, BLANK, BLANK
3 times	Pump out in Heating mode (Outdoor unit address 1)	K, 3, BLANK, 1
4 times	Pump out in Heating mode (Outdoor unit address 2)	K, 3, BLANK, 2
5 times	Pump out in Heating mode (Outdoor unit address 3)	K, 3, BLANK, 3
6 times	Pump out in Heating mode (Outdoor unit address 4)	K, 3, BLANK, 4
7 times	Vacuimg (Outdoor unit address 1)	K, 4, BLANK, 1
8 times	Vacuimg (Outdoor unit address 2)	K, 4, BLANK, 2
9 times	Vacuimg (Outdoor unit address 3)	K, 4, BLANK, 3
10 times	Vacuimg (Outdoor unit address 4)	K, 4, BLANK, 4
11 times	Vacuimg (All outdoor units)	K, 4, BLANK, A
12 times	End Key operation	-
Press and hold 1 time	Auto trial operation	K, K, BLANK, BLANK

K2 (Number of press)	Key operation	Display on segment
1 time	Refrigerant charging in Cooling mode	K, 5, BLANK, BLANK
2 times	Trial operation in Cooling mode	K, 6, BLANK, BLANK
3 times	Pump down all units in Cooling mode	K, 7, BLANK, BLANK
4 times	H/R: Checking the pipe connection H/P: Automatic setting of operation mode (Cooling/Heating) for trial operation	K, 8, BLANK, BLANK
5 times	Checking the amount of refrigerant	K 9 X X (Display of last two digits may differ depending on the progress)
6 times	Discharge mode of DC link voltage	K, A, BLANK, BLANK
7 times	Forced defrost operation	K, B, BLANK, BLANK
8 times	Forced oil collection	K, C, BLANK, BLANK
9 times	End Key operation	-

- ※ Inv1 & Inv2 voltage during discharge mode are displayed alternately.
- ※ Outdoor Power Off even when the Inverter PCB, Fan PCB is a high DC voltage charging contacts at danger.
- ※ When you run the repair and replacement of the PCB should work after the power is turned off, the DC voltage discharge. (Natural discharge until Please wait for at least 15 minutes.)
- ※ If an error occurs, the discharge mode may not work properly. In particular, E464 & E364 is power devices can be damaged. Therefore, the discharge mode, do not use.

■ Commissioning

- **After initial installation, stable operation for a certain period of time limited to operation conditions.**

	Cooling	Heating
Method of Entry	K2 Tact Switch twice	K2 Tact Switch twice
Compressor	Normal operation, but the maximum frequency limit (differ by model)	
Indoor Unit	Whole operation (The set temperature=3 C)	Whole operation (The set temperature=40 C)
Outdoor fan and valves	Normally control conduct	
Operation time	Min : 60 minutes, Max : 10 hours	
Etc.	<ul style="list-style-type: none"> · Exceed the maximum operating time at stops and waits. · Protection and control, self-diagnosis is performed. 	

■ Refrigerant filling operation

- **Operation to filling the refrigerant compressor was fixed at a certain frequency.**

	Cooling	Heating
Method of Entry	K2 Tact Switch one time	K1 Tact Switch one time
Compressor	Starting frequency (Mild Start frequency) operation	
Indoor Unit	Whole operation (The set temperature=3 C)	Whole operation (The set temperature=40 C)
Outdoor fan and valves	Normally control conduct	
Operation time	60 minutes	
Etc.	During the filling operation does not enter the special operation, such as oil recovery, defrost.	

■ Heating Pump Out

- ▶ Operation for the repair of the Individual outdoor unit, the outdoor unit refrigerant emissions to the indoor part.
- ▶ Liquid pipe service valve and the gas pipe service valve operation, the operator manually need to close.
- ▶ Observe low pressure using View Mode of K4 button if compressor operate.
If low pressure goes down below about 0.2 MPa.g : Immediately lock the gas side service valve, Pump Out operation is shut down.
(Pump out operation shut down : K1 button once more press or K3 button one time press)
- ▶ If operation of low pressure goes down below 0.1 MPa.g : Will be stopped automatically for the protection of the compressor.

How to Initiate	K1 Tact Switch 3 times~6 times
Compressor	60Hz
Indoor Unit	Whole Operation (The set temperature=40°C)
4Way Valve	ON (Heating Mode)
Outdoor Fan	Maximum air flow
Main EEV	Operation side : 700 Step (Stop side : 0 step)
Maximum Operation Time	10 minutes
Protection Control	Conduct the discharge temperature, high pressure control. (Low pressure protection control is not carried out) ※ Low pressure is outside normal limits : Operation is shut down after gas pipe manually closed.
Etc.	Entry after safety start. (Only the corresponding Outdoor Unit operation.) To pump out more than 2 : Except communication between Outdoor Unit of relevant set after working for one, remainder set makes Pump Out add.

■ Cooling Pump Down

- ▶ Recover the refrigerant of Indoor Unit and Piping to outdoor side.
- ▶ Liquid pipe service valve and the gas pipe service valve operation, the operator manually need to close.
- ▶ If the installation of the long pipe : Any refrigerant into the outdoor unit can not be recovered, therefore should use a separate container.
- ▶ Observe low pressure using View Mode of K4 button if compressor operate.
If low pressure goes down below about 0.2 MPa.g : Immediately lock the gas side service valve, Pump Out operation is shut down.
(Pump out operation shut down : K1 button once more press or K3 button one time press)
- ▶ If operation of low pressure goes down below 0.1 MPa.g : Will be stopped automatically for the protection of the compressor.

How to Initiate	K2 Tact Switch 3 times
Compressor	Address No.1 Outdoor Unit - 60Hz (Other Outdoor Unit COMP OFF)
Indoor Unit	Whole Operation (The set temperature=3°C)
4Way Valve	OFF (Cooling Mode)
Outdoor Fan	Maximum air flow
Main EEV	Operation side : 2000 Step , Stop side : 2000 step
Maximum Operation Time	30 minutes
Etc.	Does not conduct the operation of the special operation, and protection control. Pressure and temperature is outside normal limits : Operation is shut down after gas pipe manually closed.

■ Vacuum Operation

- ▶ Operation to facilitate vacuum to open the valve after the Outdoor Unit repair.

How to Initiate	K1 Tact Switch 7 times~11 times
Compressor	OFF
Indoor Unit/Outdoor Fan	OFF
4Way Valve	OFF
Valves	Open all valves maximum
Etc.	If not turn off the vacuum mode, the start of normal operation is prohibited.

■ Piping Inspection Operation

- ▶ Operation mode to check the status of the piping between the MCU and the indoor unit.
- ▶ Heat Pump Model : Outdoor temperature is more than 15°C / Cooling commissioning start
Outdoor temperature is less than 15°C / Heating commissioning start

■ Discharge Mode Operation

- ▶ Outdoor power is turned off, the Inverter PCB and Fan PCB charging a high DC voltage, so dangerous to touch.
 - To replace the PCB, first turn off the power and the begin if DC voltage is discharged.
 - If not use the discharge mode, the discharge time of about 15 minutes takes.
 - If an error occurs, the discharge mode may not properly run. (Wait until natural discharge.)
 - In particular, E 464, E364, power devices may be damaged, therefore do not use the discharge mode.
- ▶ Block the Inverter PCB 3-phase relay after connected the power, and through compressor, DC voltage is discharging.
 - INV1 and INV2 DC voltage during discharge mode are displayed alternately.
 - Discharge mode Display (Rotate the three page display, as shown below.)
'K' 'A' ' ' ' ' → DC Link Volt1 (For example, 120[V] 0 1 2 0 display)
→ DCLinkVolt2 (For example, 120[V] 0 1 2 0 display) → 'K' 'A' ' ' ' ' → DC Link Volt1 ...
- ▶ Discharge is complete, the power of the Inverter PCB and Fan PCB is being blocked, communication function is blocked, E206 will occur.
- ▶ If want operation again after complete discharge mode : Restart after K3 key to Reset or Power Reset.

■ Forced defrost operation

- ▶ **Forced defrost operation : Is operation when Frost Formation occurs in the outdoor. (When carried out the service)**

Method of Entry	K2 Tact Switch 6 times
Start pattern	Heating commissioning pattern
Defrost start	Defrost start : It is after 10 minutes which Safety Start finishes.
Defrost off	General defrost operation conditions are the same as.
Etc.	Defrost shut down and stop the normal pattern of the outdoor unit stop.

■ Forced oil recovery operation

- ▶ **Forced oil recovery operation : Oil recovery in the outdoor unit for the purpose of moving, installation if necessary.**

Method of Entry	K2 Tact Switch 7 times
Start pattern	Outdoor temperature is more than 10°C : Cooling commissioning Outdoor temperature is less than 10°C : Heating commissioning
Oil recovery start	Oil recovery start : It is after 10 minutes which Safety Start finishes.
Etc.	Oil recovery shut down and stop the normal pattern of the outdoor unit stop.

4-2-2 DVM S Models EEPROM Code Table

No.	Model Name	EEP Code
1	AM080FXVAGH/EU	DB82-01358A
2	AM100FXVAGH/EU	DB82-01359A
3	AM120FXVAGH/EU	DB82-01360A
4	AM140FXVAGH/EU	DB82-01361A
5	AM160FXVAGH/EU	DB82-01362A
6	AM180FXVAGH/EU	DB82-01363A
7	AM200FXVAGH/EU	DB82-01364A
8	AM220FXVAGH/EU	DB82-01365A
9	AM080FXVAGR/EU	DB82-01330A
10	AM100FXVAGR/EU	DB82-01331A
11	AM120FXVAGR/EU	DB82-01332A
12	AM140FXVAGR/EU	DB82-01333A
13	AM160FXVAGR/EU	DB82-01334A
14	AM180FXVAGR/EU	DB82-01335A
15	AM200FXVAGR/EU	DB82-01336A
16	AM220FXVAGR/EU	DB82-01337A
17	AM080FXMDGH/EU	DB82-01774A
18	AM090FXMDGH/EU	DB82-01776A

4-3 Troubleshooting

4-3-1 Setting Option Setup Method

4-3-1-1 PCB option code input method

- ▶ Set the indoor unit address and installation option with remote controller option.

Set the each option separately since you cannot set the ADDRESS setting and indoor unit installation setting option at the same time. You need to set twice when setting indoor unit address and installation option.

■ The procedure of setting option

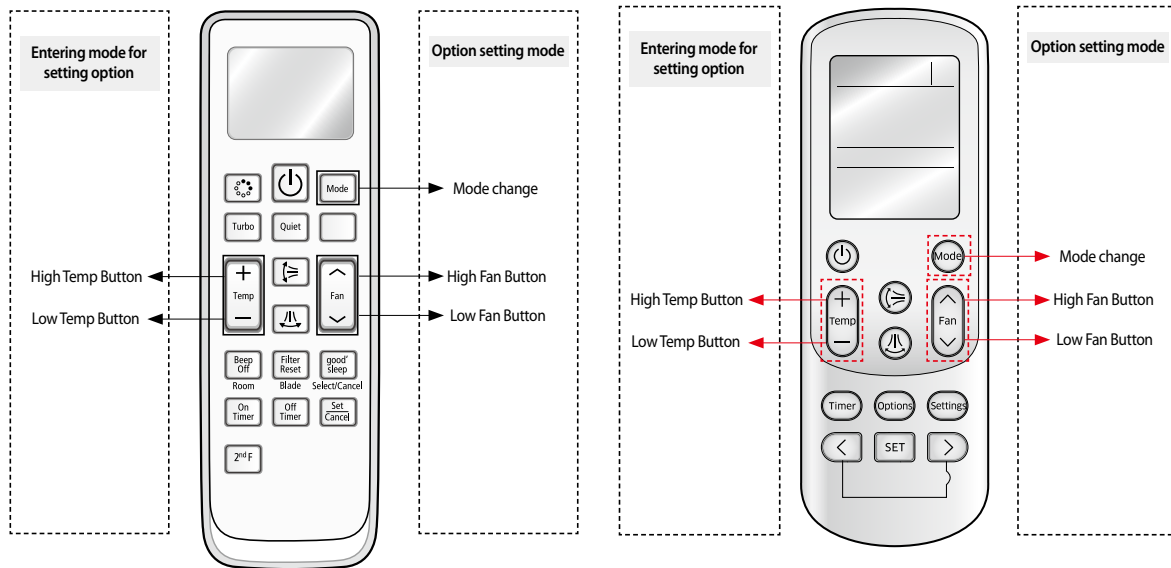

Step 1 Entering mode to set option

1. Remove batteries from the remote controller.
2. Insert batteries and enter the option setting mode while pressing High Temp button and Low Temp button .
3. Check if you have entered the option setting status.

Step 2 The procedure of option setting

After entering the option setting status, select the option as listed below.











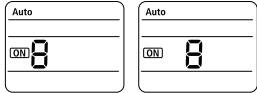

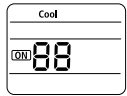
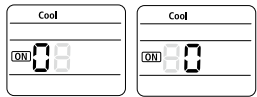
- The total number of available options are 24: SEG1 to SEG24.
- Because SEG1, SEG7, SEG13, and SEG19 are the page options used by the previous remote control models, the modes to set values for these options are skipped automatically.
- Set a 2-digit value for each option pair in the following order: SEG2 and SEG3 → SEG4 and SEG5 → SEG6 and SEG8 → SEG9 and SEG10 → SEG11 and SEG12 → SEG14 and SEG15 → SEG16 and SEG17 → SEG18 and SEG20 → SEG21 and SEG22 → SEG23 and SEG24.

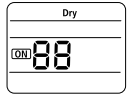
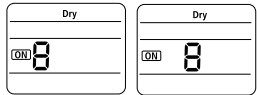

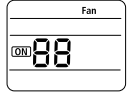
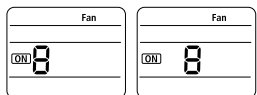
SEG1	SEG2	SEG3	SEG4	SEG5	SEG6	SEG7	SEG8	SEG9	SEG10	SEG11	SEG12
0	X	X	X	X	X	1	X	X	X	X	X
SEG13	SEG14	SEG15	SEG16	SEG17	SEG18	SEG19	SEG20	SEG21	SEG22	SEG23	SEG24
2	X	X	X	X	X	3	X	X	X	X	X

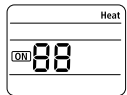
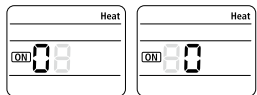
On(SEG1~12)	Off(SEG13~24)
Auto 00	Auto 00
00	00

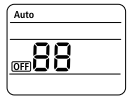
■ The procedure of setting option

Option setting	Status
<p>1. Setting SEG2, SEG3 option Press Low Fan button(∨) to enter SEG2 value. Press High Fan button(∧) to enter SEG3 value. Each time you press the button, $\bar{0} \rightarrow \bar{1} \rightarrow \dots \bar{E} \rightarrow \bar{F}$ will be selected in rotation.</p>	 <p style="text-align: center;">SEG2 SEG3</p>
<p>2. Setting Cool mode  Press Mode button to be changed to Cool mode in the ON status.</p>	
<p>3. Setting SEG4, SEG5 option Press Low Fan button(∨) to enter SEG4 value. Press High Fan button(∧) to enter SEG5 value. Each time you press the button, $\bar{0} \rightarrow \bar{1} \rightarrow \dots \bar{E} \rightarrow \bar{F}$ will be selected in rotation.</p>	 <p style="text-align: center;">SEG4 SEG5</p>
<p>4. Setting Dry mode  Press Mode button to be changed to DRY mode in the ON status.</p>	
<p>5. Setting SEG6, SEG8 option Press Low Fan button(∨) to enter SEG6 value. Press High Fan button(∧) to enter SEG8 value. Each time you press the button, $\bar{0} \rightarrow \bar{1} \rightarrow \dots \bar{E} \rightarrow \bar{F}$ will be selected in rotation.</p>	 <p style="text-align: center;">SEG6 SEG8</p>
<p>6. Setting Fan mode  Press Mode button to be changed to FAN mode in the ON status.</p>	
<p>7. Setting SEG9, SEG10 option Press Low Fan button(∨) to enter SEG9 value. Press High Fan button(∧) to enter SEG10 value. Each time you press the button, $\bar{0} \rightarrow \bar{1} \rightarrow \dots \bar{E} \rightarrow \bar{F}$ will be selected in rotation.</p>	 <p style="text-align: center;">SEG9 SEG10</p>
<p>8. Setting Heat mode  Press Mode button to be changed to HEAT mode in the ON status.</p>	
<p>9. Setting SEG11, SEG12 option Press Low Fan button(∨) to enter SEG11 value. Press High Fan button(∧) to enter SEG12 value. Each time you press the button, $\bar{0} \rightarrow \bar{1} \rightarrow \dots \bar{E} \rightarrow \bar{F}$ will be selected in rotation.</p>	 <p style="text-align: center;">SEG11 SEG12</p>
<p>10. Setting Auto mode  Press Mode button to be changed to AUTO mode in the OFF status.</p>	

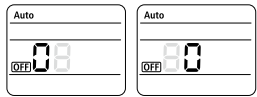
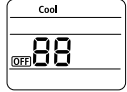
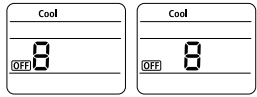
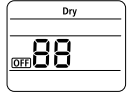
■ The procedure of setting option (cont.)

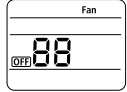
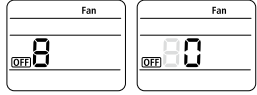
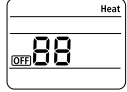
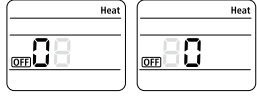
Option setting	Status
<p>11. Setting SEG14, SEG15 option Press Low Fan button(V) to enter SEG14 value. Press High Fan button(^) to enter SEG15 value. Each time you press the button, 0 → 1 → ... 9 → F will be selected in rotation.</p>	 <p style="text-align: center;">SEG14 SEG15</p>
<p>12. Setting Cool mode <input type="button" value="Mode"/> Press Mode button to be change to Cool mode in the OFF status.</p>	
<p>13. Setting SEG16, SEG17 option Press Low Fan button(V) to enter SEG16 value. Press High Fan button(^) to enter SEG17 value. Each time you press the button, 0 → 1 → ... 9 → F will be selected in rotation.</p>	 <p style="text-align: center;">SEG16 SEG17</p>
<p>14. Setting Dry mode <input type="button" value="Mode"/> Press Mode button to be change to Dry mode in the OFF status.</p>	
<p>15. Setting SEG18, SEG20 option Press Low Fan button(V) to enter SEG18 value. Press High Fan button(^) to enter SEG20 value. Each time you press the button, 0 → 1 → ... 9 → F will be selected in rotation.</p>	 <p style="text-align: center;">SEG18 SEG20</p>
<p>16. Setting Fan mode <input type="button" value="Mode"/> Press Mode button to be change to Fan mode in the OFF status.</p>	
<p>17. Setting SEG21, SEG22 option Press Low Fan button(V) to enter SEG21 value. Press High Fan button(^) to enter SEG22 value. Each time you press the button, 0 → 1 → ... 9 → F will be selected in rotation.</p>	 <p style="text-align: center;">SEG21 SEG22</p>
<p>18. Setting Heat mode <input type="button" value="Mode"/> Press Mode button to be change to HEAT mode in the OFF status.</p>	
<p>19. Setting SEG23, SEG24 mode Press Low Fan button(V) to enter SEG23 value. Press High Fan button(^) to enter SEG24 value. Each time you press the button, 0 → 1 → ... 9 → F will be selected in rotation.</p>	

Step 3 Check the option you have set

After setting option, press  button to check whether the option code you input is correct or not.

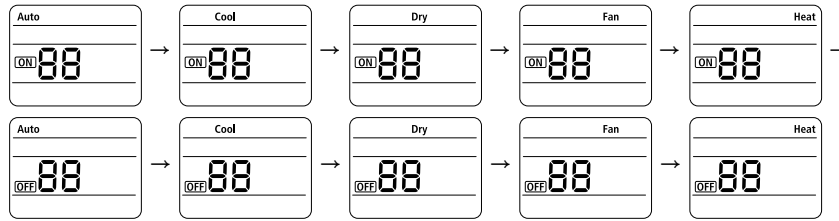

Step 4 Input option

Press operation button  with the direction of remote control for set. For the correct option setting, you must input the option twice.

Step 5 Check operation

1. Reset the indoor unit by pressing the RESET button of indoor unit or outdoor unit.
2. Take the batteries out of the remote controller and insert them again and then press the operation button.

- Setting an indoor unit address and installation option

■ Setting an indoor unit installation option (suitable for the condition of each installation location)

1. Check whether power is supplied or not.
 - When the indoor unit is not plugged in, there should be additional power supply in the indoor unit.

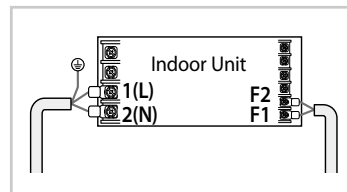

2. The panel(display) should be connected to an indoor unit to receive option.
3. Set the installation option according to the installation condition of an air conditioner.
 - The default setting of an indoor unit installation option is 020010-100000-200000-300000.
 - Individual control of a remote controller(SEG20) is the function that controls an indoor unit individually when there is more than one indoor unit.

4. Set the indoor unit option by wireless remote controller.

SEG1	SEG2	SEG3	SEG4	SEG5	SEG6
0	2	RESERVED	Exterior temperature sensor	Central control	FAN RPM compensation
SEG7	SEG8	SEG9	SEG10	SEG11	SEG12
1	Drain pump	Hot water heater	Electronic heater	Opening the electronic expansion valve	Master / Slave
SEG13	SEG14	SEG15	SEG16	SEG17	SEG18
2	External control	External control output	S-Plasma ion	Buzzer	Number of hours using filter
SEG19	SEG20	SEG21	SEG22	SEG23	SEG24
3	Individual control of a remote controller	Heating setting compensation	EEV opening of an indoor unit stopped during oil return or Defrost operation.	-	Human sensor

- ▶ 1WAY/2WAY/4WAY MODEL : Drain pump(SEG8) will be set to 'USE + 3minute delay' even if the drain pump is set to 0.
- ▶ 1 WAY/2WAY/4WAY,DUCT MODEL : Number of hours using filter(SEG18) will be set to '1000hour' even if the SEG18 is set to except for 2 or 6.
- ▶ If you input a number other than 0~4 of the individual control of the indoor unit(SEG20), the indoor is set as indoor 1.
- ▶ SEG5 central control option is basically set as 1 (Use), so you don't need to set the central control option additionally. However, if the central control is not connected but it doesn't indicate an error message, you need to set the central control option as 0 (Disuse) to exclude the indoor unit from the central control.

Option No. : 02XXXX-1XXXX-2XXXX-3XXXX

Option	SEG1		SEG2		SEG3		SEG4		SEG5		SEG6	
Explanation	PAGE		MODE		Use of robot cleaning		Use of external temperature sensor		Use of central control		FAN RPM compensation	
Remote Controller Display												
Indication and Details	Indication	Details	Indication	Details	Indication	Details	Indication	Details	Indication	Details	Indication	Details
	0	2	0	Disuse	0	Disuse	0	Disuse	0	Disuse	0	Disuse
			1	Use	1	Use	1	Use	1	Use	1	RPM compensation
2	High ceiling KIT											
Option	SEG7		SEG8		SEG9		SEG10		SEG11		SEG12	
Explanation	PAGE		Use of drain pump		Use of hot water heater		Use of electronic heater		Opening the electronic expansion valve of an indoor unit when heating operation stops.		Master / Slave	
Remote Controller Display												
Indication and Details	Indication	Details	Indication	Details	Indication	Details	Indication	Details	Indication	Details	Indication	Details
	1		0	Disuse	0	Disuse	0	Disuse	0	0	0	slave
			1	Use	1	Use	1	Use	1	80	1	master
2			Use + 3minute delay									
Option	SEG13		SEG14		SEG15		SEG16		SEG17		SEG18	
Explanation	PAGE		Use of external control		Setting the output of external control		S-Plasma ion		Buzzer control		Number of hours using filter	
Remote Controller Display												
Indication and Details	Indication	Details	Indication	Details	Indication	Details	Indication	Details	Indication	Details	Indication	Details
	2		0	Disuse	0	Thermo on	0	Disuse	0	Mixed operation control1/Use buzzer	2	1000 Hour
			1	ON/OFF Control	1	Operation on	1	Use	1	Mixed operation control1/ Disuse of buzzer	6	2000 Hour
			2	OFF Control					2	Mixed operation control2/Use buzzer		
3	Mixed operation control2/ Disuse of buzzer											
Option	SEG19		SEG20		SEG21		SEG22		SEG23		SEG24	
Explanation	PAGE		Individual control of a remote controller		Heating setting compensation		EEV opening of an indoor unit stopped during oil return or defrost operation.		-		Human sensor	
Remote Controller Display												
Indication and Details	Indication	Details	Indication	Details	Indication	Details	Indication	Details	Indication	Details	Indication	Details
	3		0 or 1	channel 1	0	Disuse	0	150 step			8	Disuse
			2	channel 2	1	2°C	1	0 step			9	Use
			3	channel 3	2	5°C						
4			channel 4									

Installation options for the O2 series

SEG1	SEG2	SEG3	SEG4	SEG5	SEG6
0	2	-	Use of external temperature sensor / Minimizing fan operation when thermostat is off	Use of central control	Compensation of the fan RPM
SEG7	SEG8	SEG9	SEG10	SEG11	SEG12
1	Use of drain pump	Use of hot water heater	-	EEV step when heating stops	-
SEG13	SEG14	SEG15	SEG16	SEG17	SEG18
2	Use of external control	Setting the output of external control / External heater On or Off signal	-	Buzzer control	Maximum filter usage time
SEG19	SEG20	SEG21	SEG22	SEG23	SEG24
3	Individual control with remote control	Heating setting compensation offset / Removing condensated water in the Heat mode	EEV step of stopped unit during the oil return or the defrost mode	Motion detection sensor	Cycle time of Swing

- Even if you set the Use of drain pump (SEG8) option to 0, it is automatically set to 2 (the drain pump is used with 3 minute delay).
- If you set the Maximum filter usage time (SEG18) option to a value other than 2 and 6, it is automatically set to 2 (1000 hours).
- If you set an option to a value that is out of range specified above, the option is automatically set to 0 by default.
- The SEG5 option (Use of central control) is set to 1 (Use) by default. Therefore, you don't need to set the SEG5 option additionally. Note that even if the central control system is not connected, no errors occur. If you want a specific indoor unit not to be controlled by the central control system, set the SEG option of that indoor unit to 0 (Disuse).
- The external output of SEG15 is generated via MIM-B14 connection. (Refer to the manual of MIM-B14.)
- If you set the Individual control with remote control (SEG20) option to a value other than 0 to 4, it is automatically set to 0 (Indoor 1).

Installation options for the O2 series (detailed)

Option No. for an indoor unit address: 02XXXX-1XXXXX-2XXXXX-3XXXXX

Option	SEG1		SEG2		SEG3		SEG4			SEG5		SEG6	
Function	Page		Mode		-		Use of external temperature sensor / Minimizing fan operation when thermostat is off			Use of central control		Compensation of the fan RPM	
Indication and details	Indication	Details	Indication	Details	-		Indication	Details		Indication	Details	Indication	Details
	0		2		-			Use of external temperature sensor	Minimizing fan operation when thermostat is off				
							0	Disuse	(Cooling, Heating) Disuse	1	Use	4	Disuse (exposed installation)
							1	Use	(Cooling, Heating) Disuse				
							2	Disuse	(Heating) Use (*2)				
							3	Use	(Heating) Use (*2)				
							4	Disuse	(Cooling) Use				
							5	Use	(Cooling) Use				
							6	Disuse	(Cooling, Heating) Use (*2)				
7	Use	(Cooling, Heating) Use (*2)	5	High-ceiling mode (exposed installation)									
Option	SEG7		SEG8		SEG9		SEG10			SEG11		SEG12	
Function	Page		Use of drain pump		Use of hot water heater		-			EEV step when heating stops		-	
Indication and detail	Indication	Details	Indication	Details	Indication	Details	-			Indication	Details	-	
	1		0	Disuse	0	Disuse				0	Default		
			1	Use	1	Use (*3)				1	Noise decreasing setting		
			2	Use with 3 minute delay	2	-							
		3	Use (*3)										

Option	SEG13		SEG14		SEG15			SEG16		SEG17		SEG18	
Function	Page		Use of external control		Setting the output of external control / External heater On or Off signal			S-Plasma ion		Buzzer control		Maximum filter usage time	
Indication and details	Indication	Details	Indication	Details	Indication	Details		Indication	Details	Indication	Details	Indication	Details
						Setting the output of external control	External heater On or Off signal						
	2		0	Disuse	0	Thermo On	-	0	Disuse	0	Use of buzzer	2	1000 hours
			1	ON or OFF control	1	Operation On	-	1	Use	1	Disuse of buzzer	6	2000 hours
			2	OFF control	2	-	Use (*4)						
3	Window ON or OFF control	3	-	Use (*4)									
Option	SEG19		SEG20		SEG21			SEG22		SEG23		SEG24	
Function	Page		Individual control with remote control		Heating setting compensation offset / Removing condensated water in the Heat mode			EEV step of stopped unit during the oil return or the defrost mode		Motion detection sensor		Cycle time of Swing	
Indication and details	Indication	Details	Indication	Details	Indication	Details		Indication	Details	Indication	Details	Indication	Details
						Heating setting compensation offset	Removing condensated water in the Heat mode						
	3		0 or 1	Indoor 1	0	Default (*5)	Disuse	0	Default	0	Disuse	0	34 seconds (default)
					1	2 °C	Disuse	1	Oil return or Noise decreasing in defrost mode	1	Turn out in 30 min. without motion	1	30 seconds
2			Indoor 2	2	5 °C	Disuse	2			Turn out in 60 min. without motion	2	38 seconds	

Indication and details	3	3	Indoor 3	3	Default (*5)	Use (*6)	1	Oil return or Noise decreasing in defrost mode	2	Turn out in 60 min. without motion	2	38 seconds
		4	Indoor 4	4	2 °C	Use (*6)			3	Turn out in 120 min. without motion		
				5	5 °C	Use (*6)			5	Turn out in 180 min. without motion		
		6	Turn out in 60 min. without motion or advanced function (*1)									
		7	Turn out in 120 min. without motion or advanced function (*1)									
		8	Turn out in 180 min. without motion or advanced function (*1)									

- (*1) Advanced function: Either controlling the cooling or heating current or power saving with motion detection.
- (*2) Minimizing fan operation when thermostat is off :
The fan operates for 20 seconds at an interval of 5 minutes in the Heat mode.
- (*3) 1: The fan is turned on continually when the hot water heater is turned on,
3: The fan is turned off when the hot water heater is turned on with cooling only indoor unit.
(Cooling only indoor unit: To use this option, install the Mode Select switch (MCM-C200) on the outdoor unit and fix it to the Cool mode.)
- (*4) When the following 2 or 3 is used as external heater On or Off signal, the signal for monitoring external contact control will not be output.
2: The fan is turned on continually when the external heater is turned on,
3: The fan is turned off when the external heater is turned on with cooling only indoor unit
(Cooling only indoor unit: To use this option, install the Mode Select switch (MCM-C200) on the outdoor unit and fix it to the Cool mode.)
- (*5) Default setting value: 5 °C
- (*6) If the air conditioner operates in the Heat mode immediately after finishing the cooling operation, the condensed water in the drain pan becomes water steam by the heat of the indoor unit heat exchanger. Since the water steam might be condensed on the indoor unit, which may fall into a living space, use this function to remove the water steam out of the indoor unit by operating the fan (for maximum 20 minutes) although the indoor unit is turned off after the Cool mode is turned to the Heat mode.

Installation options for the 05 series

SEG1	SEG2	SEG3	SEG4	SEG5	SEG6
0	5	Use of the HR-specific auto changeover function in the Auto mode	(When setting SEG3) Offset for the heating reference temperature	(When setting SEG3) Offset for the cooling reference temperature	(When setting SEG3) Reference for change from Heat mode to Cool mode
SEG7	SEG8	SEG9	SEG10	SEG11	SEG12
1	(When setting SEG3) Reference for change from Cool mode to Heat mode	(When setting SEG3) Time required for mode change	Compensation option for a long pipe and the height difference between indoor units	-	-
SEG13	SEG14	SEG15	SEG16	SEG17	SEG18
2	-	-	-	-	Control variables when the hot water heater or an external heater is used
SEG19	SEG20	SEG21	SEG22	SEG23	SEG24
3	-	-	-	-	-

4-3-2 Option Items

Item	Model	SEG																								Static Pressure
		1	2	3	4	5	6	7	8	9	10	11	12	13	14	15	16	17	18	19	20	21	22	23	24	
WIND FREE 4Way	AM045NN4DEH/** AM045NN4DEH/**	0	1	4	0	4	F	1	9	5	0	9	7	2	0	2	D	2	D	3	3	0	0	0	0	
	AM056NN4DEH/** AM056NN4DEH/**	0	1	4	0	4	F	1	9	5	0	A	7	2	0	3	8	3	8	3	3	0	0	0	0	
	AM071NN4DEH/** AM056NN4DEH/**	0	1	4	0	4	F	1	9	4	0	B	8	2	0	4	7	4	7	3	3	0	0	0	0	
	AM090NN4DEH/** AM090NN4DEH/**	0	1	4	0	4	F	1	9	5	0	F	9	2	0	5	A	5	A	3	3	0	0	0	0	
	AM112NN4DEH/** AM112NN4DEH/**	0	1	4	0	4	F	1	9	5	4	1	A	2	0	7	0	7	0	3	3	0	0	1	0	
	AM128NN4DEH/** AM128NN4DEH/**	0	1	4	0	4	F	1	9	5	4	2	C	2	0	8	0	8	0	3	3	0	0	2	1	
	AM140NN4DEH/** AM140NN4DEH/**	0	1	4	0	4	F	1	9	5	4	4	C	2	0	8	C	8	C	3	3	0	0	2	0	
	WIND FREE Mini 4Way	AM015NNNDEH/** AM015NNNDEH/**	0	1	5	0	4	F	1	9	7	0	B	8	2	0	0	F	0	F	3	3	0	0	0	0
AM022NNNDEH/** AM022NNNDEH/**		0	1	5	0	4	F	1	9	7	0	E	8	2	0	1	6	1	6	3	3	0	0	0	0	
AM028NNNDEH/** AM028NNNDEH/**		0	1	5	0	4	F	1	9	5	4	0	A	2	0	1	C	1	C	3	3	0	0	0	0	
AM036NNNDEH/** AM036NNNDEH/**		0	1	5	0	4	F	1	9	3	4	2	A	2	0	2	4	2	4	3	3	0	0	0	0	
AM045NNNDEH/** AM045NN4DEH/**		0	1	5	0	4	F	1	9	5	4	4	E	2	0	2	D	2	D	3	3	0	0	0	0	
AM056NNNDEH/** AM056NNNDEH/**		0	1	5	0	4	F	1	9	5	4	7	F	2	0	3	8	3	8	3	3	0	0	0	1	
AM060NNNDEH/** AM0660NNNDEH/**		0	1	5	0	4	F	1	9	5	5	9	1	2	0	3	C	3	C	3	3	0	0	0	3	
WIND FREE 4Way		AM009NN4DCH/**	0	1	4	0	4	F	1	9	5	0	9	7	2	0	1	A	1	A	3	3	0	0	0	0
	AM012NN4DCH/**	0	1	4	0	4	F	1	9	5	0	9	7	2	0	2	3	2	3	3	3	0	0	0	0	
	AM018NN4DCH/**	0	1	4	0	4	F	1	9	5	0	9	7	2	0	3	4	3	4	3	3	0	0	0	0	
	AM024NN4DCH/**	0	1	4	0	4	F	1	9	5	0	C	7	2	0	4	8	4	8	3	3	0	0	0	0	
	AM030NN4DCH/**	0	1	4	0	4	F	1	9	5	4	0	9	2	0	5	A	5	A	3	3	0	0	2	0	
	AM036NN4DCH/**	0	1	4	0	4	F	1	9	5	4	1	B	2	0	6	E	6	E	3	3	0	0	2	0	
	AM048NN4DCH/**	0	1	4	0	4	F	1	9	5	4	4	F	2	0	9	1	9	1	3	3	0	0	2	3	
WIND FREE Mini 4Way	AM005NNNDCH/**	0	1	5	0	4	F	1	9	7	0	B	8	2	0	0	F	0	F	3	3	0	0	0	0	
	AM007NNNDCH/**	0	1	5	0	4	F	1	9	7	0	E	8	2	0	1	6	1	6	3	3	0	0	0	0	
	AM009NNNDCH/**	0	1	5	0	4	F	1	9	5	4	0	A	2	0	1	C	1	C	3	3	0	0	0	0	
	AM012NNNDCH/**	0	1	5	0	4	F	1	9	3	4	2	C	2	0	2	3	2	3	3	3	0	0	0	2	
	AM018NNNDCH/**	0	1	5	0	4	F	1	9	5	4	7	F	2	0	3	8	3	8	3	3	0	0	0	1	
	AM020NNNDCH/**	0	1	5	0	4	F	1	9	5	5	9	1	2	0	3	C	3	C	3	3	0	0	0	3	

4-3-3 What to check before diagnosis

4-3-3-1 Lamp combination expression method display (cassette type indoor unit)

- Global 4way cassette type

■ Error detection and restart













- When error occurs during operation, indicate a problem with LED flashes, and no other operations but LED stops.
- When restarting operation with remote controller or switch, it will determine the appropriate error mode after normal operation.

■ LED lamp display with error detection

Abnormal condition	Error code	LED Display			
		Operation	Defrost	Timer	Filter
					
Error on indoor temperature sensor (Short or Open)	E121	×		×	×
1. Error on Eva-in sensor (Short or Open) 2. Error on Eva-out sensor (Short or Open) 3. Discharge sensor error (Short or Open)	E122 E123 E126			×	×
Indoor fan error	E154	×	×		×
1. Error on outdoor temperature sensor (Short or Open) 2. Error on cond sensor 3. Error on discharge sensor Other outdoor unit sensor error that is not on the above list	E221 E237 E251		×		×
1. When there is no communication between the indoor-outdoor units for 2 minutes 2. Communication error received from the outdoor unit 3. 3 minute tracking error on outdoor unit 4. Communication error after tracking due to unmatching number of installed units 5. Error due to repeated communication address 6. Communication address not confirmed Other outdoor unit communication error that is not on the above list	E101 E102 E202 E201 E108 E109	×			×
Self diagnosis error display 1. Error due to opened EEV (2nd detection) 2. Error due to closed EEV (2nd detection) 3. Eva in sensor is detached 4. Eva out sensor is detached 5. Thermal fuse error (Open)	E151 E152 E128 E129 E198	×			
1. COND mid sensor is detached. 2. Refrigerant leakage (2nd detection) 3. Abnormally high temperature on Cond (2nd detection) 4. Low pressure s/w (2nd detection) 5. Abnormally high temperature on discharged air on outdoor unit (2nd detection) 6. Indoor operation stop due to unconfirmed error on outdoor unit 7. Error due to reverse phase detection 8. Comp stop due to freeze detection (6th detection) 9. High pressure sensor is detached 10. Low pressure sensor is detached 11. Outdoor unit copression ration error 12. Outdoor sump down_1 prevetion control 13. Compressor down due to low pressure sensor prevention control_1 14. Simultaneous opening of cooling/heating MCU SOL valve (1st detection) 15. Simultaneous opening of cooling/heating MCU SOL valve (2nd detection) Other outdoor unit self-diagnosis error that is not on the above list	E241 E554 E450 E451 E416 E559 E425 E403 E301 E306 E428 E413 E410 E180 E181	×			
Flowating s/w (2nd detection)	E153	×	×		
EEPROM error	E162				

- Global 4way cassette type

■ LED lamp display with error detection (cont.)

Abnormal condition	Error code	LED Display			
		Operation	Defrost	Timer	Filter
					
EEPROM option error	E163				
Error due to incompatible indoor unit	E164				

● : On ○ : Flickering × : Off

- If you turn off the air conditioner when the LED is flickering, the LED is also turned off.
 - If you re-operate the air conditioner, it operates normally at first, then detect an error again.
 - When E108 error occurs, change the address and reset the system.
- Ex.) When address of the indoor unit #1 and #2 are set as 5, address of the indoor unit #1 will become 5 and indoor unit #2 will display E108, A002.

4-3-4 Number Display Method (Outdoor Unit, MCU, Cable remote control, wall-mount, etc.)

■ How to Display Integrated Error Code

▶ Meanings of First Alphabetical Character / Number of Error Code

Displayed alphabet	Explanation	
<i>E</i>	When displaying Error 101~700	
<i>P</i>	When displaying Error 701~800	
<i>C</i>	When E206 occurs	Displays address of subordinate within the set C001 : HUB, C002: FAN, C003: INV1, C004: INV2
	When MCU error occurs	Displays address of MCU Ex) C100: MCU address 0, C101: MCU address 1, C102: MCU address 2
<i>U</i>	When displaying outdoor unit address Ex) U200: Outdoor unit 1, U201: Outdoor unit 2, U202: Outdoor unit 3, U203: Indoor unit 4	
<i>A</i>	When displaying indoor unit address Ex) A000: Indoor unit address 0, A001: Indoor unit address 1, A002: Indoor unit address 2	

▶ Order of Error Display

Classification	Error display method	Display Example
Display method for error that occurred in indoor unit	Error Number → Indoor unit address → Error Number, repeat display	E471 → A002 → E471 → A002
Display method for error that occurred in outdoor unit and other methods of error display	Error Number → Outdoor unit address → Error Number, repeat display	E471 → U200 → E471 → U200 E206 → C001 → E206 → C002

■ **Diagnosis and Adjustment (Error Code)**

► **Error code related indoor unit**

CODE	Explanation
E-101	Indoor unit communication error. Indoor unit can not receive any data from outdoor unit.
E-102	Communication error between indoor unit and outdoor unit. Displayed in indoor unit
E-108	Error due to repeated address setting (When 2 or more devices has same address within the network)
E-109	Communication address not confirmed other outdoor unit communication error that is not on the above list
E-110	Communication error between Hydro unit HT(Main PBA) and Control kit PBA(Detection from the Control kit)
E-121	Error on indoor temperature sensor of indoor unit (Short or Open)
E-122	Error on EVA IN sensor of indoor unit (Short or Open)
E-123	Error on EVA OUT sensor of indoor unit (Short or Open)
E-128	EVA IN temperature sensor of indoor unit is detached from EVA IN pipe
E-129	EVA OUT temperature sensor of indoor unit is detached from EVA OUT pipe
E-130	Heat exchanger in/out sensors of indoor unit are detached
E-135	RPM feedback error of indoor unit's cleaning fan
E-151	Error due to opened EEV of indoor unit (2nd detection)
E-152	Error due to closed EEV of indoor unit (2nd detection)
E-153	Error on floating switch of indoor unit (2nd detection)
E-154	RPM feedback error of indoor unit
E-161	Mixed operation mode error of indoor unit; When outdoor unit is getting ready to operate in cooling (or heating) and some of the indoor unit is trying to operate in heating (or cooling) mode
E-162	EEPROM error of MICOM (Physical problem of parts/circuit)
E-163	Indoor unit's remote controller option input is Incorrect or missing. Outdo or unit EEPROM data error
E-180	Simultaneous opening of cooling/heating MCU SOL V/V (1st detection)
E-181	Simultaneous opening of cooling/heating MCU SOL V/V (2nd detection)
E-185	Cross wiring error between communication and power cable of indoor unit
E-186	Connection error or problem on SPI
E-190	No temperature changes in EVA IN during pipe inspection or changes in temperature is seen in indoor unit with wrong address
E-191	No temperature changes in EVA OUT during pipe inspection or changes in temperature is seen in indoor unit with wrong address
E-198	Error due to disconnected thermal fuse of indoor unit
E-201	Communication error between indoor and outdoor units (installation number setting error, repeated indoor unit address, indoor unit communication cable error)
E-202	Communication error between indoor and outdoor units (Communication error on all indoor unit, outdoor unit communication cable error)
E-203	Communication error between main and sub outdoor units
E-205	Communication error on all PBA within the outdoor unit C-Box, communication cable error
E-206	E206-C001: HUB PBA communication error / E206-C002: FAN PBA communication error E206-C003: INV1 PBA communication error / E206-C004: INV2 PBA communication error

■ Diagnosis and Adjustment (Error Code)

► Error code related to the Communications / Settings / HW (cont.)

CODE	Explanation
E-211	When single indoor unit uses 2 MCU ports that are not in series
E-212	If the rotary switch (on the MCU) for address setting of the indoor unit has 3 or more of the same address
E-213	When total number of indoor units assigned to MCU is same as actual number of installed indoor units but there is indoor unit that is not installed even though it is assigned on MCU
E-214	When number of MCU is not set correctly on the outdoor unit or when two or more MCU was installed some of them have the same address
E-215	When two different MCU's have same address value on the rotary switch
E-216	When indoor unit is not installed to a MCU port but the switch on the port is set to On
E-217	When indoor unit is connected to a MCU port but indoor unit is assigned to a MCU and the switch on the port is set to Off
E-218	When there's at least one or more actual number of indoor unit connection compared to number of indoor units assigned to MCU
E-219	Error on temperature sensor located on MCU intercooler inlet (Short or Open)
E-220	Error on temperature sensor located on MCU intercooler outlet (Short or Open)
E-221	Error on outdoor temperature sensor of outdoor unit (Short or open)
E-231	Error on COND OUT temperature sensor of main outdoor unit (Short or Open)
E-241	COND OUT sensor is detached
E-251	Error on discharge temperature sensor of compressor 1 (Short or Open)
E-257	Error on discharge temperature sensor of compressor 2 (Short or Open)
E-262	Discharge temperature sensor of compressor 1 is detached from the sensor holder on the pipe
E-263	Discharge temperature sensor of compressor 2 is detached from the sensor holder on the pipe
E-266	Top sensor of compressor 1 is detached
E-267	Top sensor of compressor 2 is detached
E-269	Suction temperature sensor is detached from the sensor holder on the pipe
E-276	Error on top sensor of compressor 1 (Short or Open)
E-277	Error on top sensor of compressor 2 (Short or Open)
E-291	Refrigerant leakage or error on high pressure sensor (Short or Open)
E-296	Refrigerant leakage or error on low pressure sensor (Short or Open)
E-308	Error on suction temperature sensor (Short or Open)

■ Diagnosis and Adjustment (Error Code)

► Error code related to the Communications / Settings / HW (cont.)

CODE	Explanation
E-311	Error on temperature sensor of double layer pipe/liquid pipe(sub heat exchanger) (Short or Open)
E-321	Error on EVI (ESC) IN temperature sensor (Short or Open)
E-322	Error on EVI (ESC) OUT temperature sensor (Short or Open)
E-323	Error on suction sensor 2 (Short or Open)
E-346	Error due to operation failure of Fan2
E-347	Motor wire of Fan2 is not connected
E-348	Lock error on Fan2 of outdoor unit
E-353	Error due to overheated motor of outdoor unit's Fan2
E-355	Error due to overheated IPM of Fan2
E-361	Error due to operation failure of inverter compressor 2
E-364	Error due to over-current of inverter compressor 2
E-365	V-limit error of inverter compressor 2
E-366	Error due to over voltage /low voltage of inverter PBA2
E-367	Error due to unconnected wire of compressor 2
E-368	Output current sensor error of inverter PBA2
E-369	DC voltage sensor error of inverter PBA2
E-374	Heat sink temperature sensor error of inverter PBA2
E-378	Error due to overcurrent of Fan2
E-385	Error due to input current of inverter 2
E-386	Over-voltage/low-voltage error of Fan2
E-387	Hall IC connection error of Fan2
E-389	V-limit error on Fan2 of compressor
E-393	Output current sensor error of Fan2
E-396	DC voltage sensor error of Fan2
E-399	Heat sink temperature sensor error of Fan2
E-400	Error due to overheat caused by contact failure on IPM of Inverter PBA2
E-407	Compressor operation stop due to high pressure protection control
E-410	Compressor operation stop due to low pressure protection control or refrigerant leakage
E-416	Compressor operation stop due to discharge temperature protection control
E-425	Phase reversal or phase failure (3Ø outdoor unit wiring, R-S-T-N), connection error on 3 phase input
E-428	Compressor operation stop due abnormal compression ratio
E-438	EVI (ESC) EEV leakage or internal leakage of intercooler or incorrect connector insertion of EVI (ESC) EEV
E-439	Error due to refrigerant leakage
E-440	Heating mode restriction due to high air temperature
E-441	Cooling mode restriction due to low air temperature
E-442	Refrigerant charging restriction in heating mode when air temperature is over 15 °C
E-443	Operation prohibited due to the pressure drop
E-445	CCH is deatched
E-446	Error due to operation failure of Fan1

■ Diagnosis and Adjustment (Error Code)

► Error code related to the Communications / Settings / HW (cont.)

CODE	Explanation
E-447	Motor wire of Fan1 is not connected
E-448	Lock error on Fan1
E-452	Error due to ZPC detection circuit problem or power failure
E-453	Error due to overheated motor of outdoor unit's Fan1
E-455	Error due to overheated IPM of Fan1
E-461	Error due to operation failure of inverter compressor 1
E-462	Compressor stop due to full current control or error due to low current on CT2
E-464	Error due to over-current of inverter compressor 1
E-465	V-limit error of inverter compressor 1
E-466	Error due to over voltage /low voltage of inveter PBA1
E-467	Error due to unconnected wire of compressor 1
E-468	Output current sensor error of inverter PBA1
E-469	DC voltage sensor error of inver PBA1
E-474	Heat sink temperature sensor error of inverter PBA1
E-478	Error due to overcurrent of Fan1
E-485	Error due to input current of inverter 1
E-486	Error due to over voltage/low voltage of Fan
E-487	Hall IC error of Fan1
E-489	V-limit error on Fan1 of compressor
E-493	Output current sensor error of Fan1
E-496	DC voltage sensor error of Fan1
E-499	Heat sink temperature sensor error of Fan1
E-500	Error due to overheat caused by contact failure on IPM of Inverter PBA1
E-503	Error due to alert the user to check if the service valve is closed
E-504	Error due to self diagnosis of compressor operation
E-505	Error due to self diagnosis of high pressure sensor
E-506	Error due to self diagnosis of low pressure sensor
E-560	Outdoor unit's option switch setting error (when inappropriate option switch is on)
E-563	Error due to module installation of indoor unit with old version (Micom version needs to be checked)
E-573	Error due to using single type outdoor unit in a module installation
E-601	Communication error between remote controller and the DVM Hydro unit / Hydro unit HT
E-602	Communication error between master and slave remote controller
E-604	Tracking error between remote controller and the DVM Hydro unit / Hydro unit HT
E-618	Error due to exceeding maximum numbers of Hydro unit installation (16 units)
E-627	Error due to exceeding maximum numbers of wired remote controller installation (2 units)
E-633	Error caused by installing mixed models
E-653	Remote controller's temperature sensor is disconnected or has problem
E-654	Data error on remote controller (Memory read/write error)

■ Diagnosis and Adjustment (Error Code)

▶ Error code related to the Communications / Settings / HW (cont.)

CODE	Explanation
E-702	Error due to closed EEV of indoor unit (1st detection)
E-703	Error due to opened EEV of indoor unit (1st detection)
E-901	Error on the sensor of water inlet pipe (Short or Open)
E-902	Error on the sensor of water outlet pipe (Short or Open)
E-904	Error on water tank (Short or open)
E-907	Error due to pipe rupture protection
E-908	Error due to freeze prevention(Re-operation is possible)
E-909	Error due to freeze prevention(Re-operation is impossible)
E-910	Water temperature sensor on water outlet pipe is detached
E-911	Flow switch off error, When the switch is turned off within 10 seconds after a pump starts its operation(Re-operation is possible)
E-913	Six times detection for Flow Switch Error(Re-operation is not possible)
E-914	Error due to incorrect thermostat connection
E-915	Error on DC fan(Non-operating)
E-917	Water Tank Sensor Configuration Error
UP	Trial operation incompleted (UnPrepared) - It will be cleared when trial operation was executed for 1 hour or when automatic inspection is completed

4-4 Appropriate Measures for Different Symptom

4-4-1 Outdoor Unit Operation Flow

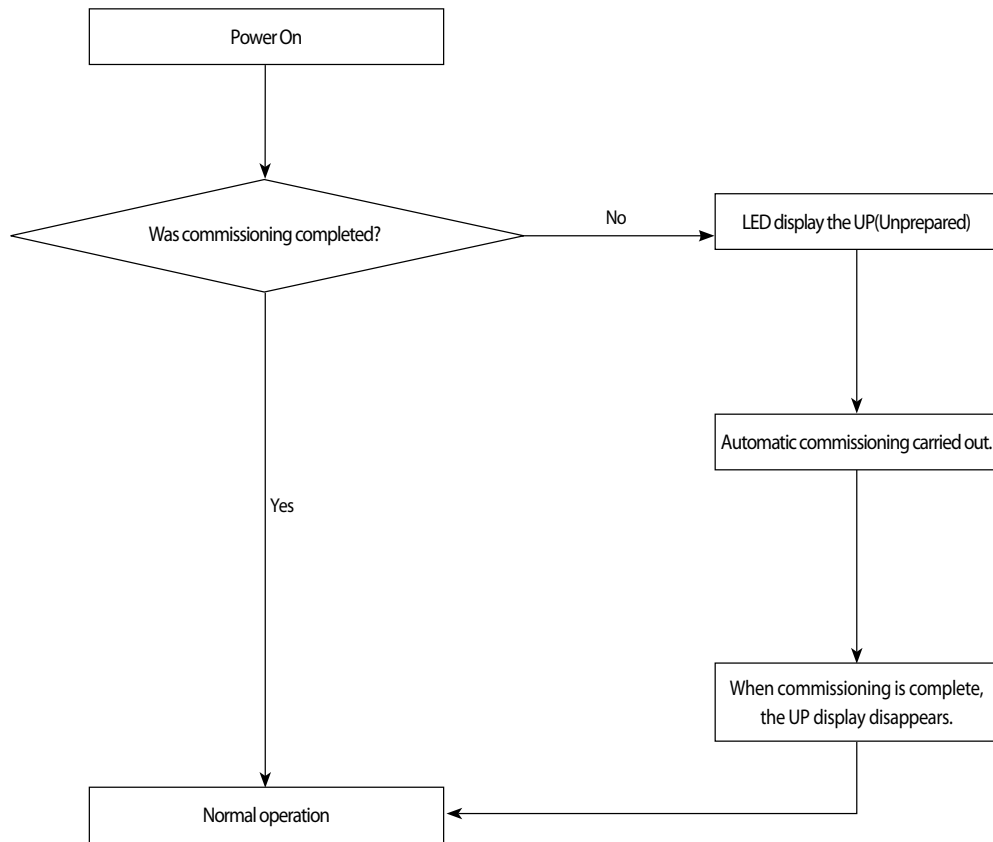

Commissioning if it is not running - UP is displayed

Prior to starting the air conditioning operation after the initial installation and automatic commissioning is carried out. This process, the stable operation to protect the system and verify the defect of the product.

1. Tracking is complete and after the initial installation, if you do not have a history of commissioning is completed, UP will be displayed.
2. Execute the automatic commissioning by Tact Switch.
3. UP display disappears after commissioning is complete, normal operation is possible.
4. Automatic commissioning is completed, if there is a history, normal operation execution immediately.

4-4-2 Main PCB has no power phenomenon

Outdoor unit display	Main PCB has no power phenomenon (7-seg does not blink)
Judgment Method	Hub PCB power and connection wire to detect.
Cause of problem	<ul style="list-style-type: none"> · HUB PCB connector wire defects and the connection is not. · Main PCB defective. · Hub PCB defective. · High pressure switch operation

1. Cause of problem

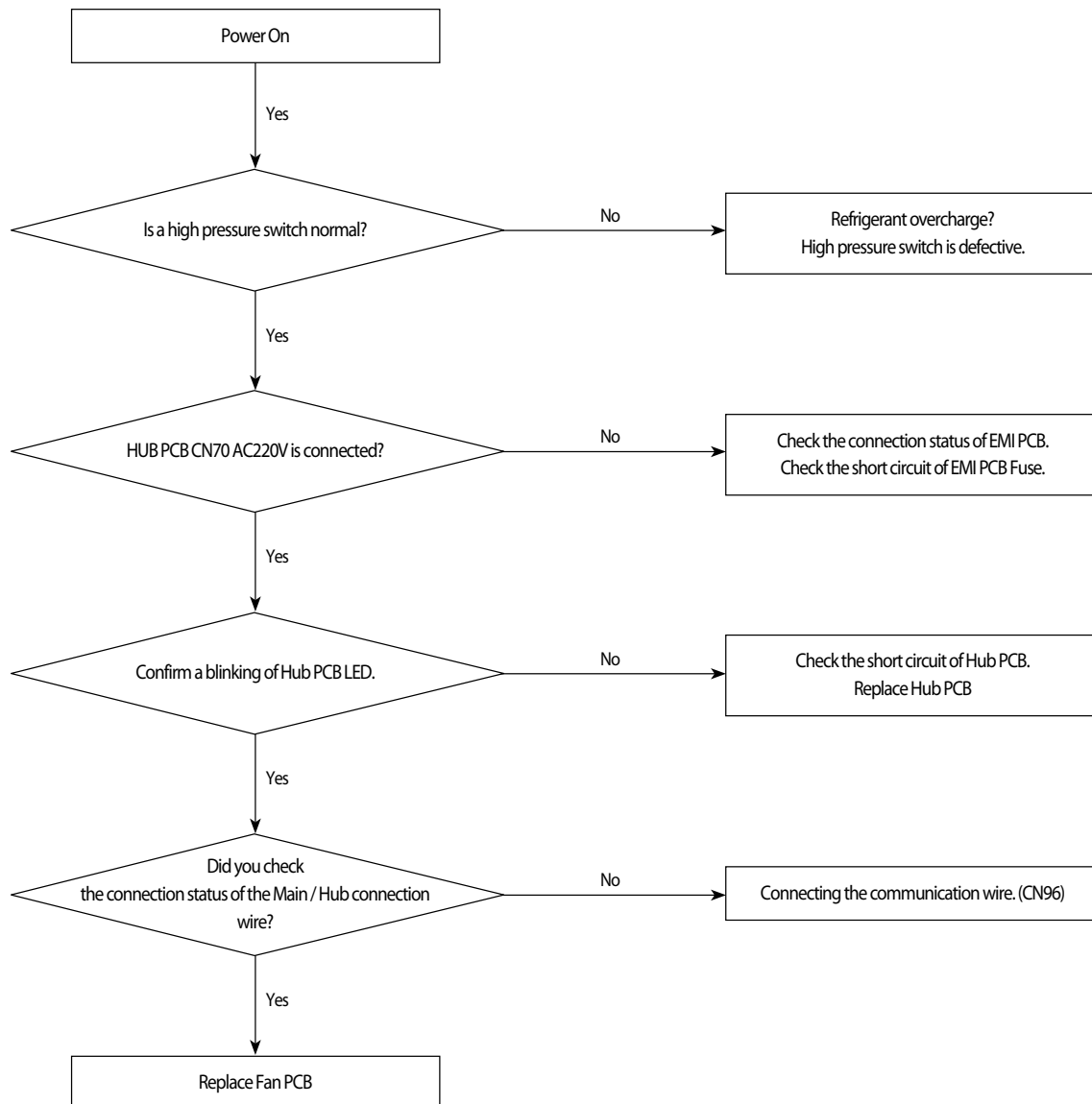

4-4-3 Indoor Unit ROOM sensor Error (Open/Short)

Outdoor unit display	E 121 → A xxx (xxx : The address of the error occurred indoor unit)																
Indoor unit display	Duct, Cassette (1 way / 2 way / Mini-4 way)				4 Way Cassette Type				Wall mounted Type				Circular Cassette Type				
	Display LED																
	1 way Blue Yellow-Green		or or	or or	Operation	Defroster	Timer	Filter	18 °C	21 °C	Reser- vation	24 °C	27 °C	Sky- Blue	Yellow- Green	Blue	Red
	2 way Green Red				⏻	⏻	⏻	⏻	⏻	⏻	⏻	⏻	⏻	⏻	⏻	⏻	⏻
x x		●	x	x	x	●	x	x	x	x	x	x	x	x	x	x	●

Criteria • Refer to how to determine below

Cause of problem • The room temperature sensor of No. XXX indoor unit has defective OPEN/SHORT

1. How to check

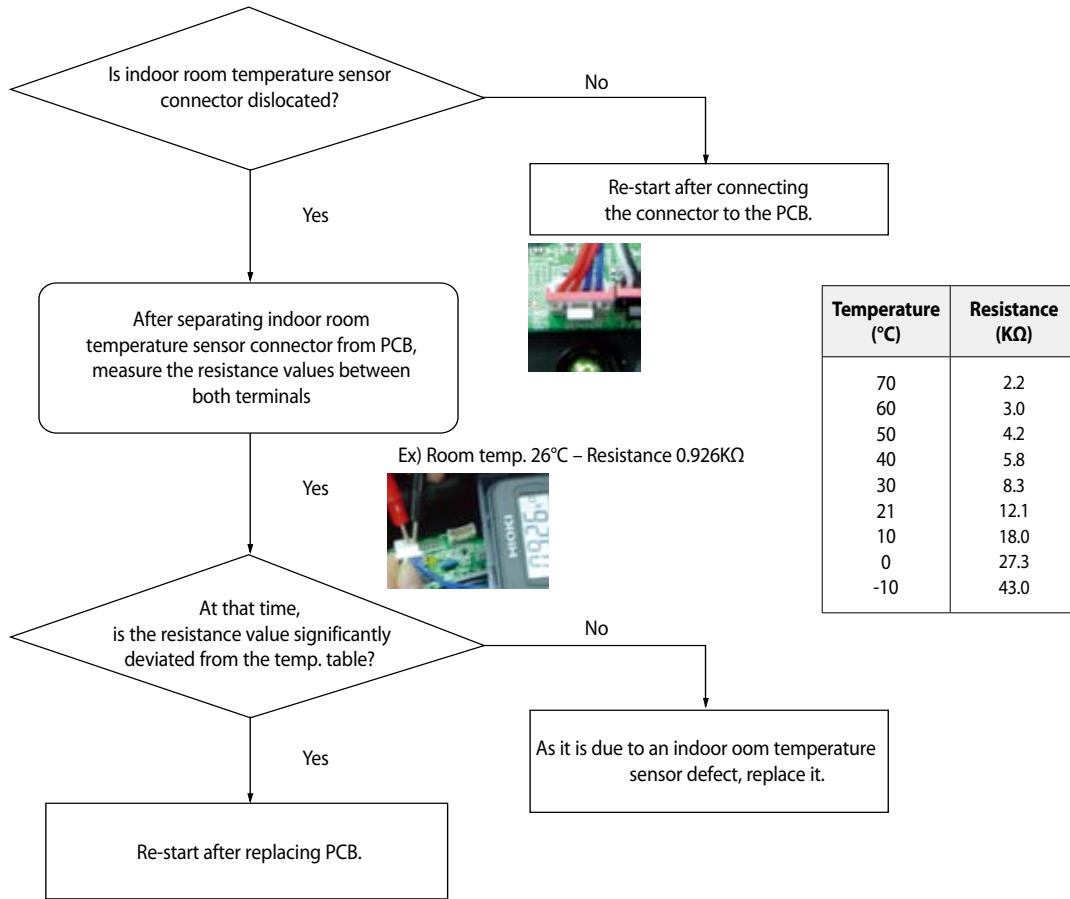

4-4-4 Indoor unit EVAP IN sensor Error (Open/Short)

Outdoor unit display	E 122 ↔ A xxx (xxx : The address of the error occurred indoor unit)																
Indoor unit display	Duct, Cassette (1 way / 2 way / Mini-4 way)				4 Way Cassette Type				Wall mounted Type				Circular Cassette Type				
	Display LED																
	1 way Blue Yellow-Green		or or	or or	Operation	Defroster	Timer	Filter	18 °C	21 °C	Reser- -vation	24 °C	27 °C	Sky- Blue	Yellow- Green	Blue	Red
	2 way Green Red				⏻	⏻	⏻	⏻	⏻	⏻	⏻	⏻	⏻	⏻	⏻	⏻	⏻
●	×	●	×	×	●	●	×	×	●	×	●	×	×	×	●	×	●
Criteria	• Refer to how to determine below																
Cause of problem	• The EVAP IN sensor of No. XXX indoor unit has defective OPEN/SHORT																

1. How to check

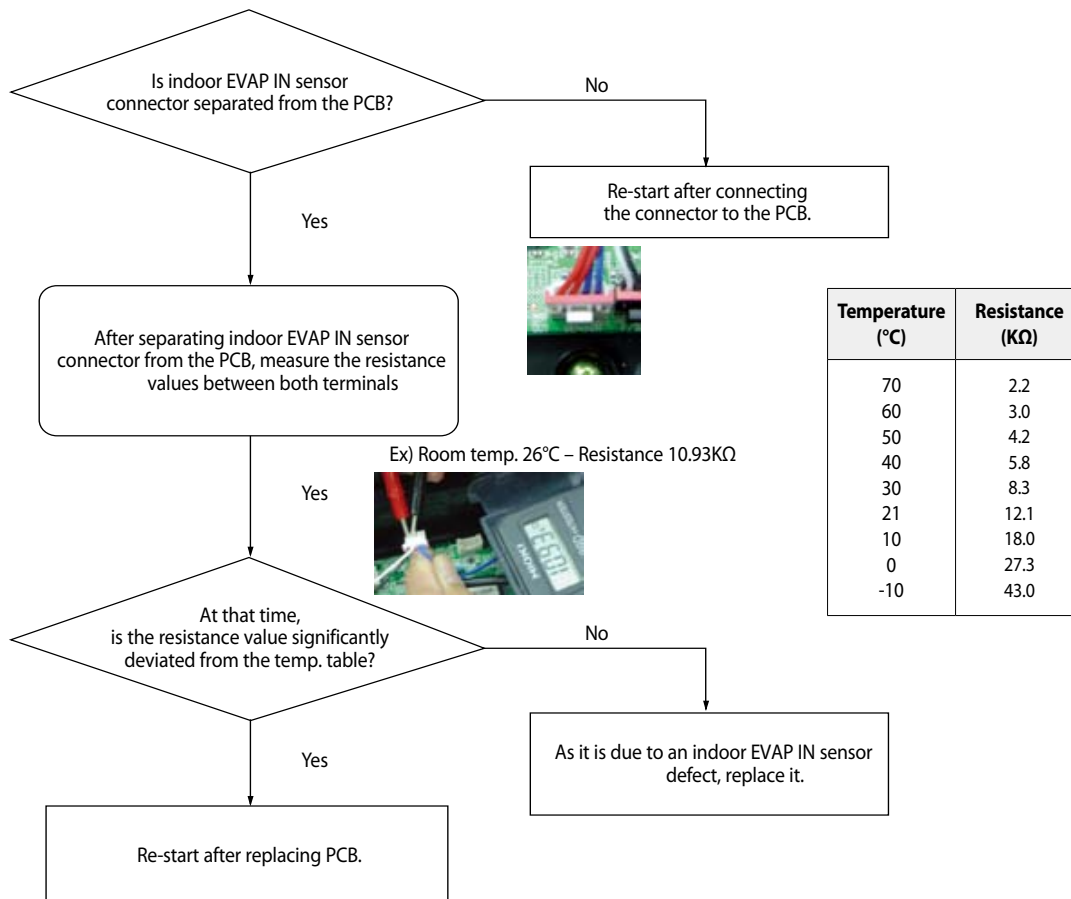

4-4-5 Indoor EVAP OUT sensor Error (Open/Short)

Outdoor unit display	E 123 ← A x x x (x x x : The address of the error occurred indoor unit)																			
Indoor unit display	Duct, Cassette (1 way / 2 way / Mini-4 way)				4 Way Cassette Type				Wall mounted Type				Circular Cassette Type							
	Display LED																			
	1 way	Blue	Yellow-Green	Green	Red	or	or	Operation	Defroster	Timer	Filter	18 °C	21 °C	Reser- vation	24 °C	27 °C	Sky- Blue	Yellow- Green	Blue	Red
2 way	Green	Red	or	or	or	or	or	or	or	or	or	or	or	or	or	or	or	or	or	or
	●	×	●	×	×	●	●	×	×	●	×	●	×	×	×	×	●	×	●	
Criteria	• Refer to how to determine below																			
Cause of problem	• The EVAP out sensor of No. XXX indoor unit has defective OPEN/SHORT																			

1. How to check

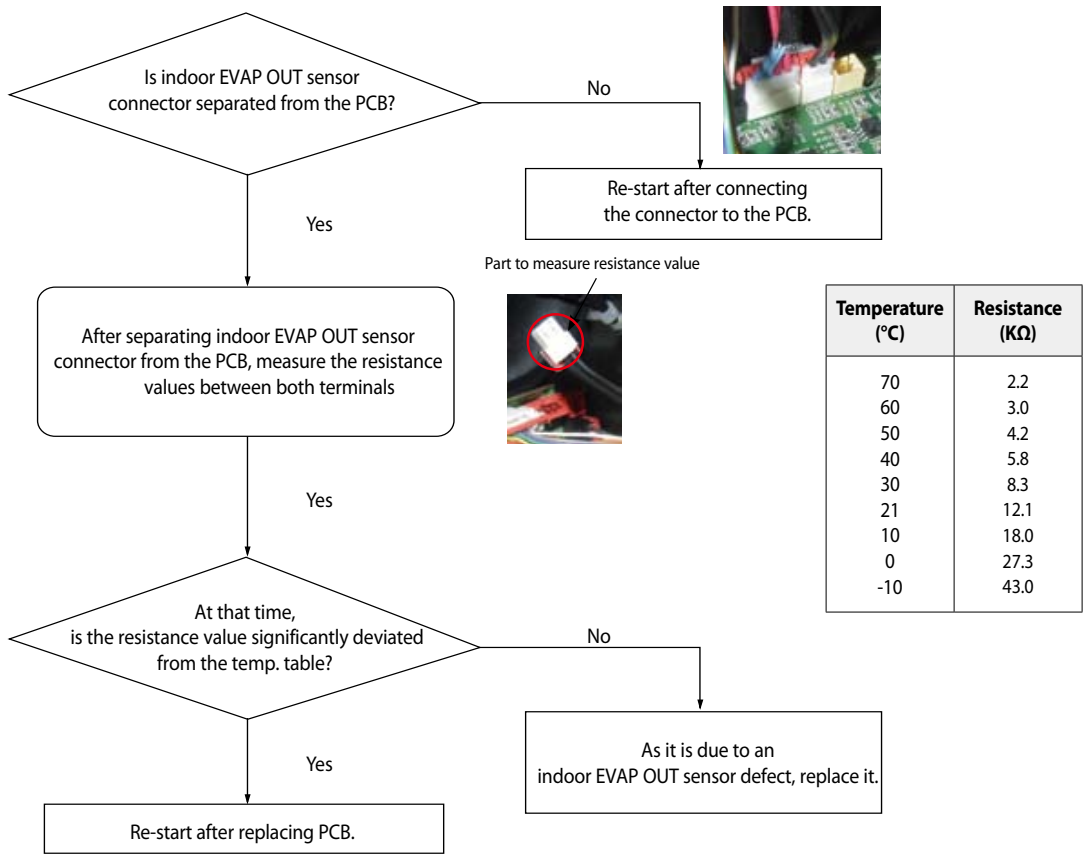

4-4-6 Indoor Heat Exchanger's EVAP IN sensor dislocation error

Outdoor unit display	E 128 ↔ A x x x (x x x : The address of the error occurred indoor unit)																
Indoor unit display	Duct, Cassette (1 way / 2 way / Mini-4 way)			4 Way Cassette Type				Wall mounted Type			Circular Cassette Type						
	Display LED																
	1 way Blue Yellow-Green		or	or	Operation	Defroster	Timer	Filter	18 °C	21 °C	Reser- -vation	24 °C	27 °C	Sky- -Blue	Yellow- -Green	Blue	Red
	2 way Green Red				or	or	or	or	or	or	or	or	or	or	or	or	or
x	x	●	●	●	x	●	●	●	x	x	●	●	●	x	x	●	x
Criteria	• Refer to how to determine below																
Cause of problem	• Indoor heat exchanger's EVAP IN piping sensor has been dislocated																

1. How to diagnose

1) During Cooling Operation

Tcond, out - Tair, out > 3°C	OK
Tair, in - Teva, out > 4°C	NO
Tair, in - Teva, out > 4°C	OK
Compressor in operation & Indoor Unit operation & Thermo On	OK
Error details	Breakaway Error of Indoor Heat Exchanger EVA Out sensor

* Hydro Unit : Before and after the Compressor operation, EVA Out temperature difference is less than 3°C.

2) During Heating operation

Average high pressure > 25kg/cm ²	OK
Average low pressure > 8.5kg/cm ²	OK
Tcond, out - Tair, out ≥ 3°C	OK
Tair, in - Teva, out ≥ 2°C	NO
Tcond, out - Tair, out < -2°C	OK
Compressor in operation & Indoor Unit operation & Thermo On	OK
Error details	Breakaway Error of Indoor Heat Exchanger EVA Out sensor

2. How to check

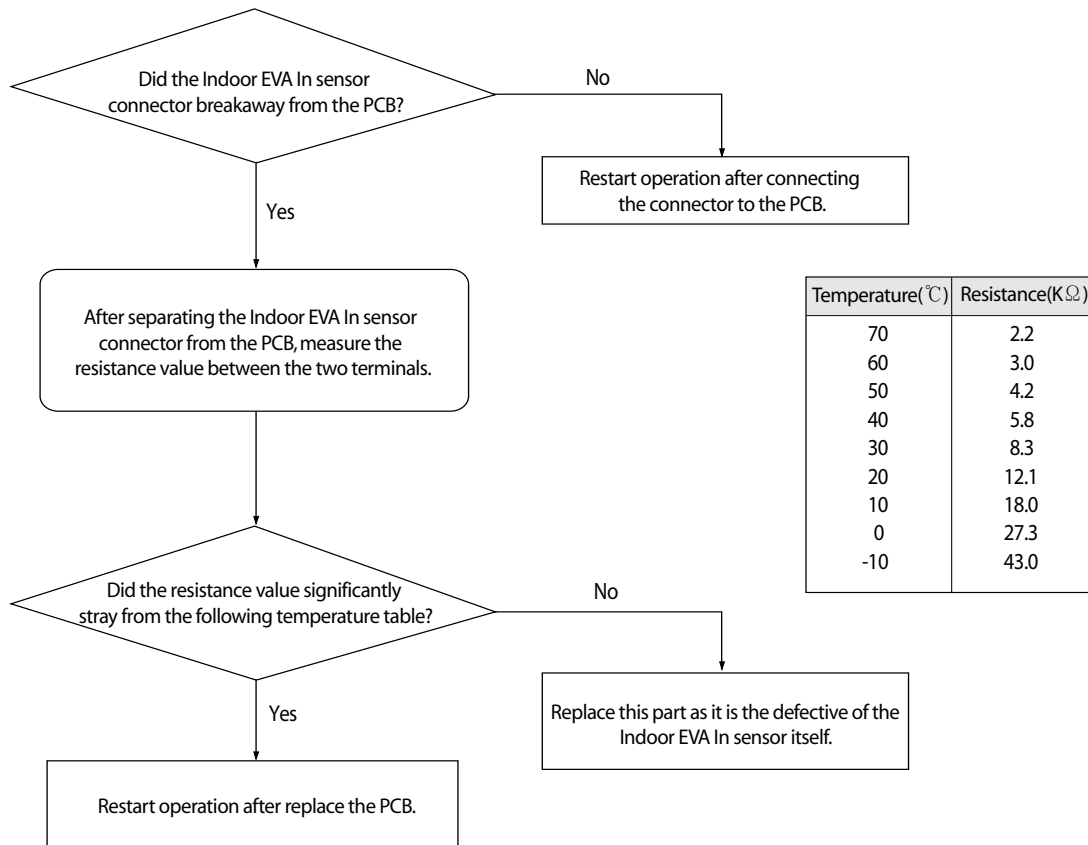

4-4-7 Indoor Heat Exchanger's EVA OUT sensor dislocation error (Open/Short)

Outdoor unit display	E 129 → A ××× (×××: The address of the error occurred indoor unit)																
Indoor unit display	Duct, Cassette (1 way / 2 way / Mini-4 way)				4 Way Cassette Type				Wall mounted Type				Circular Cassette Type				
	Display LED																
	1 way		or	or	Operation	Defroster	Timer	Filter	18 °C	21 °C	Reser- -vation	24 °C	27 °C	Sky- -Blue	Yellow- -Green	Blue	Red
	Blue	Yellow- -Green			or	or	or	or	or	or	or	or	or	or	or	or	or
2 way		or	or	Operation	Defroster	Timer	Filter	18 °C	21 °C	Reser- -vation	24 °C	27 °C	Sky- -Blue	Yellow- -Green	Blue	Red	
Green	Red			or	or	or	or	or	or	or	or	or	or	or	or	or	or
Criteria	• Refer to the judgment method below.																
Cause of problem	• Breakaway of Indoor Heat Exchanger EVA Out sensor																

1. How to diagnose

1) During Cooling Operation

Tcond, out - Tair, out > 3°C	OK
Tair, in - Teva, out > 4°C	NO
Tair, in - Teva, out > 4°C	OK
Compressor in operation & Indoor Unit operation & Thermo On	OK
Error details	Breakaway Error of Indoor Heat Exchanger EVA Out sensor

* Hydro Unit : Before and after the Compressor operation, EVA Out temperature difference is less than 3°C.

2) During Heating operation

Average high pressure > 25kg/cm ²	OK
Average low pressure > 8.5kg/cm ²	OK
Tcond, out - Tair, out ≥ 3°C	OK
Tair, in - Teva, out ≥ 2°C	NO
Tcond, out - Tair, out < -2°C	OK
Compressor in operation & Indoor Unit operation & Thermo On	OK
Error details	Breakaway Error of Indoor Heat Exchanger EVA Out sensor

2. How to check

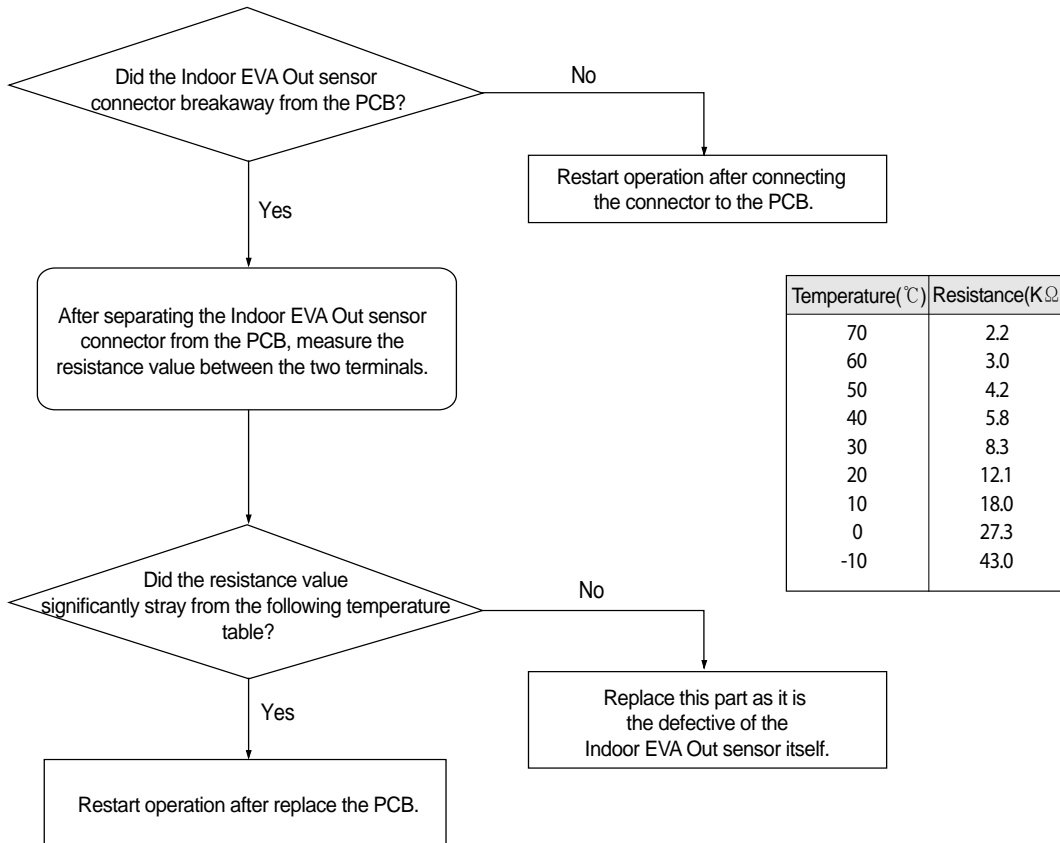

4-4-8 imultaneous Indoor Heat Exchanger's EVA IN, OUT sensor dislocation error (Open/Short)

1. How to diagnose

1) During Cooling Operation

Tcond, out - Tair, out > 3°C	OK
Tair, in - Teva, out > 4°C	NO
Tair, in - Teva, out > 4°C	NO
Compressor in operation & Indoor unit operation & Thermo On	OK
Error details	Simultaneous indoor heat exchanger's EVA IN, OUT sensor dislocation error

2) During Heating operation

Average high pressure > 25kg/cm ²	OK
Average low pressure > 8.2kg/cm ²	OK
Teva, out - Tair, out ≥ 3°C	NO
Tair, in - Teva, out ≥ 2°C	NO
Tcond, out - Tair, out < -2°C	OK
Compressor in operation & Indoor unit operation & Thermo On	OK
Error details	Simultaneous Indoor heat exchanger's EVA IN, OUT sensor dislocation error

2. How to check

Check if an Indoor heat exchanger's EVA IN, OUT sensor has been dislocated then is correct after assembling.

4-4-9 Electronic Expansion Valve opening malfunction (2nd stage) - E 135

Outdoor unit display	1st detection : P703 (Outdoor Unit display only) 2nd detection : E 135 ↔ A ××× (××× : The address of the error occurred indoor unit)
Indoor unit display	×(Operation) ×(Timer) ●(Fan) ×(Filter) ×(Defrost)
Criteria	• Refer to the judgment method below.
Cause of problem	• Faulty Indoor Unit EEV action. (Refrigerant will leak into the stopped Indoor Unit.)

1. How to diagnose

- During Cooling operation, the temperature of the inlet or outlet of stopped Heat Exchanger is kept lower than 0°C for more than 20 minutes without cessation.
- Hydro Unit : During the defrost operation, detection from stop-side Indoor Unit. (Temperature of the inlet of Heat Exchanger is kept lower than 0°C for more than 20 minutes without cessation.)

2. How to check

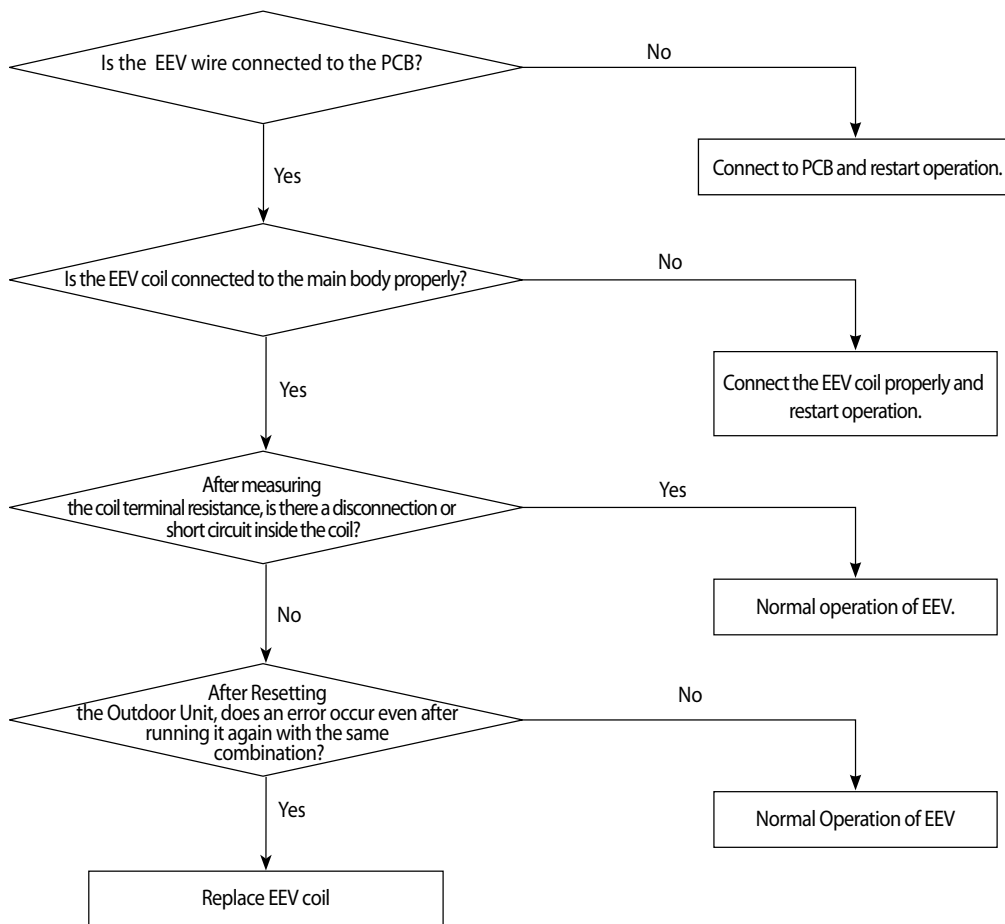

*** How to turn off the Hydro Unit E151**

- Hydro Unit PCB k1, k2 switch : At the same time push for more than 4 seconds.
- After resolving the cause of the error, restart operation.
- (Excessive reset operation, can cause damage to the Heat Exchanger.)

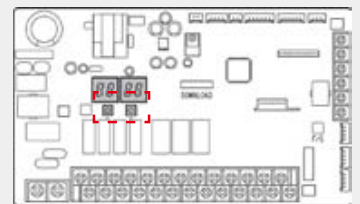

4-4-10 Breakdown of EEV (2nd)

1. How to diagnose
Detect only on cooling operation. (No detection during heating operation.)
During cooling operation, the temperature of the inlet or outlet ducts of heat exchanger is kept below 0°C for more than 20 minutes without cessation
2. How to check
 - 1) Check if the wire of electronic expansion valve is correctly connected to the PCB of indoor unit.
 - 2) Check if the coil of an electronic expansion valve is correctly plugged into the main body.
 - 3) Check if there is any rust on the surface of the electronic expansion valve with naked eyes then check the resistance between each terminal to find any wire breaking or short circuit.
 - 4) Press the RESET KEY (K3) of the outdoor unit then see if the same error occurs.
 - In case of closure problem, operate the indoor unit in which the error has occurred.
 - In case of opening problem, please do not operate the indoor unit in which the error has occurred.
 - 5) If there is no problem with the above checkup items, replace the electronic expansion valve of the troubled indoor unit.
 - As an electronic expansion valve replacement is tricky work that requires collecting refrigerants in all systems, please check the above items before replacement.

4-4-11 Problem with EEV closure (2nd)

1. How to diagnose

1) During Cooling operation(Each of the below conditions have to be met for at least 20 minutes.)

Tcond, out - Tair, out > 3°C	OK
Tair, in - Teva, out > 4°C	NO
Tair, in - Teva, out > 4°C	NO
Compressor in operation & Indoor unit operation & Thermo On	OK
Error details	Electrically operated valve closure breakdown

2) During heating operation (must satisfy all conditions below)

- When more than 2 indoor units are on Thermo On heating operation.
- When average high pressure is over 18kg/cm²
- 5 minutes after finishing Safety Start
- Keep Indoor units' T(Eva_In)<T(Room) +3°C and T(Eva_Out)<T(Room) +3°C condition for more than 5 minutes

2. How to check

- 1) Check if the wire of electronic expansion valve is correctly connected to the PCB of indoor unit.
- 2) Check if the coil of electronic expansion valve is correctly plugged into the main body.
- 3) Check if there is any rust on the surface of the electronic expansion valve with naked eye then check the resistance between each terminal to find any wire breaking or short circuit.
- 4) Press the RESET KEY (K3) of the outdoor unit then see if the same error occurs.
 - In case of closure problem, operate the indoor unit in which the error has occurred.
 - In case of opening problem, please do not operate the indoor unit in which the error has occurred.
- 5) If there is no problem with the above checkup items, replace the electronic expansion valve of the troubled indoor unit.
 - As electronic expansion valve replacement is tricky work that requires collecting refrigerants in all systems, please check the above items before replacement.

4-4-12 EEV(Electronic Expansion Valve) opening malfunction (2nd stage)

Outdoor unit display	1st detection : P703 (Outdoor Unit display only) 2nd detection : <i>E 15 1</i> ↔ <i>A</i> ^{x x x} (x x x : The address of the error occurred indoor unit)																
Indoor unit display	Duct, Cassette (1 way / 2 way / Mini-4 way)				4 Way Cassette Type				Wall mounted Type				Circular Cassette Type				
	Display LED																
	1 way Blue Yellow-Green	2 way Green Red	or or	or or	Operation	Defroster	Timer	Filter	18 °C	21 °C	Reser- -vation	24 °C	27 °C	Sky- -Blue	Yellow- -Green	Blue	Red
×	×	●	●	●	×	●	●	●	×	×	●	●	●	×	×	●	×
Criteria	• Refer to the judgment method below.																
Cause of problem	• Faulty Indoor Unit EEV action. (Refrigerant will leak into the stopped Indoor Unit.)																

- How to diagnose
Detect only on cooling operation. (No detection during heating operation.)
During Cooling operation, the temperature of the inlet or outlet of stopped Heat Exchanger is kept lower than 0°C for more than 20 minutes without cessation.
- How to check

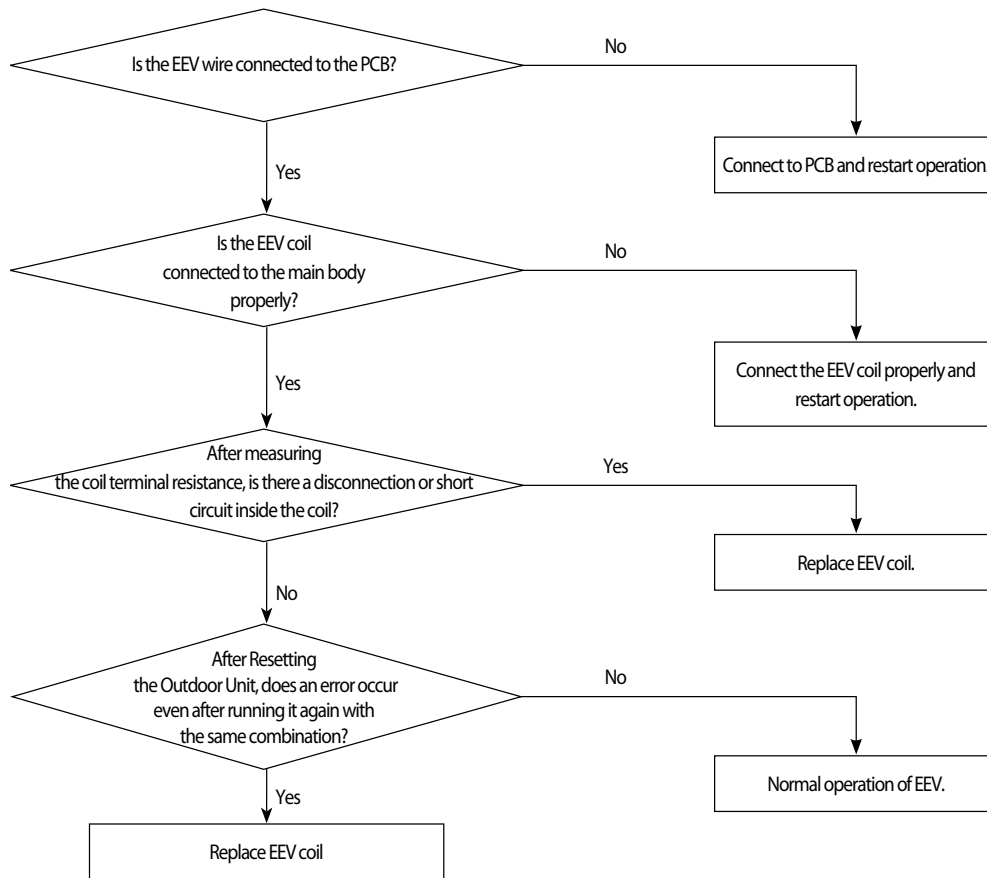

- How to turn off the Hydro Unit E151
 - Hydro Unit PCB k1, k2 switch : At the same time push for more than 4 seconds.
 - After resolving the cause of the error, restart operation. (Excessive reset operation, can cause damage to the Heat Exchanger.)

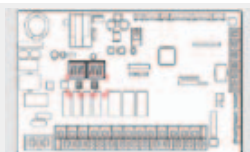

4-4-13 E 152 : EEV(Electronic Expansion Valve) closure malfunction (2nd stage)

Outdoor unit display	1st detection : P702 (Outdoor Unit display only) 2nd detection : E 152 ↔ A × × × (× × × : The address of the error occurred indoor unit)																		
Indoor unit display	Duct, Cassette (1 way / 2 way / Mini-4 way)				4 Way Cassette Type				Wall mounted Type				Circular Cassette Type						
	Display LED																		
	1 way	Blue	Yellow-Green	2 way	Green	Red	Start /Stop	Defroster	Reser- -vation	Filter -clean	18 °C	21 °C	Reser- -vation	24 °C	27 °C	Sky- -Blue	Yellow- -Green	Blue	Red
×	×																		
Criteria	• Refer to the judgment method below.																		
Cause of problem	• Faulty Indoor Unit EEV action. (EEV does not open.)																		

1. How to diagnose

1) During Cooling operation. (Each of the below conditions have to be met for at least 20 minutes.)

Tcond,out - Tair,out > 3°C	OK
Tair,in - Teva,in > 4°C	NO
Tair,in - Teva,out > 4°C	NO
Compressor in operation & Indoor unit operation & Thermo ON	OK
Error details	Indoor Unit EEV closure breakdown

2) During heating operation (must satisfy all conditions below)

- When more than 2 indoor units are on Thermo ON heating operation.
- When average high pressure is over 18kg/cm² 5 minutes after finishing Safety Start .
- Keep Indoor Unit T(Eva_In) < T(Room) + 3°C and T(Eva_Out)<T(Room) + 3°C condition for more than 5 minutes.

2. How to check

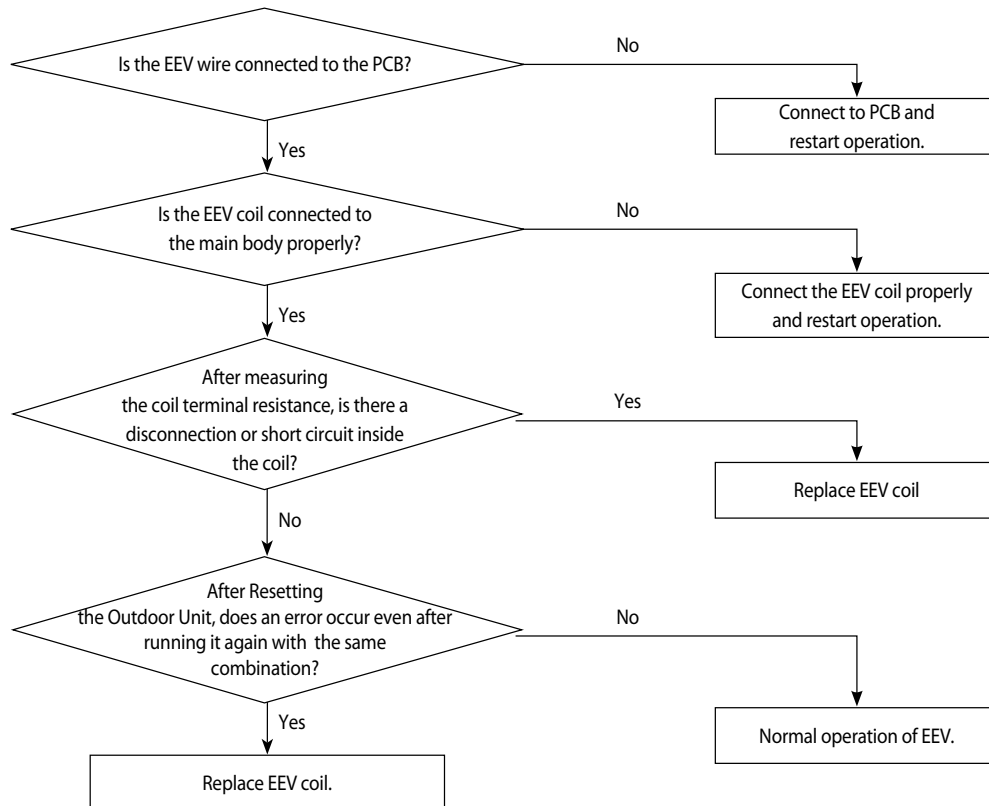

4-4-14 E 153 : Detection of Floating Switch of Indoor Unit's Drain Pump

Outdoor unit display	E 153 ↔ A ××X(x x x : The address of the error occurred indoor unit)												
Indoor unit display	Duct, Cassette (1 way / 2 way / Mini-4 way)				4 Way Cassette Type				Circular Cassette Type				
	Display LED												
	1 way Blue	Yellow-Green	or ⌚	or ⌚	or ⌚	Operation	Defroster	Timer	Filter	Sky-Blue	Yellow-Green	Blue	Red
	2 way Green	Red				⌚	⌚	⌚	⌚				
×	×	×	○	○	×	×	○	○	×	○	○	×	
Criteria													
Cause of problem													

* To release E153 error, you must reset the power of the indoor unit.

1. How to check

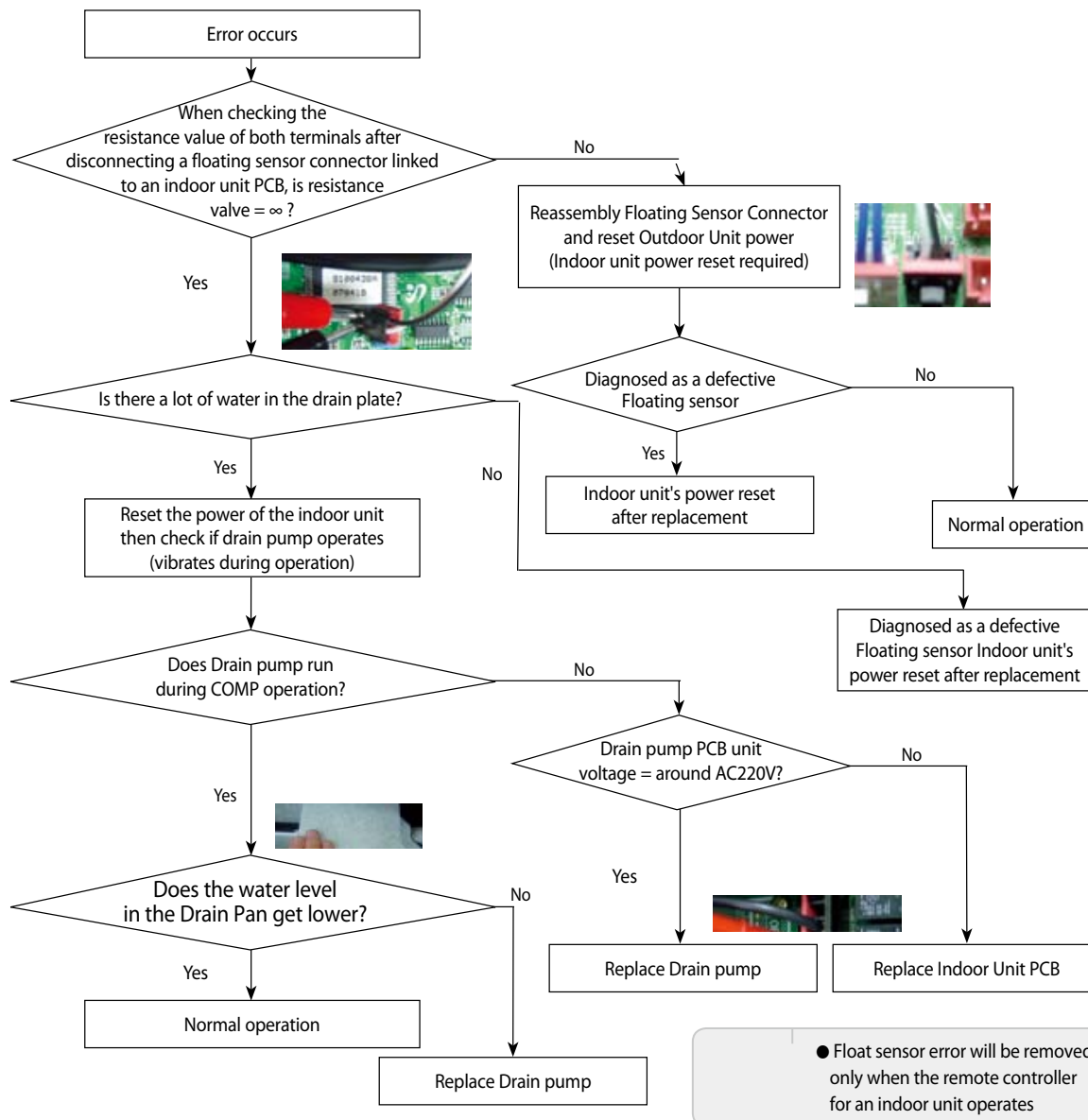

4-4-15 The operational error of Indoor Unit's Fan Motor

Outdoor unit display	E 154 ↔ A x x x (x x x : The address of the error occurred indoor unit)																	
Indoor unit display	Duct, Cassette (1 way / 2 way / Mini-4 way)				4 Way Cassette Type				Wall mounted Type				Circular Cassette Type					
	Display LED																	
	1 way Blue Yellow-Green		⌚	or ⌚	or ⌚	Operation	Defroster	Timer	Filter	18 °C	21 °C	Reser- vation	24 °C	27 °C	Sky- Blue	Yellow- Green	Blue	Red
	2 way Green Red					⌚	⌚	⌚	⌚	⌚	⌚	⌚	⌚	⌚	⌚	⌚	⌚	⌚
x	x	x	x	⌚	x	x	⌚	x	x	x	x	x	x	x	x	⌚	⌚	
Criteria	• Refer to the judgment method below.																	
Cause of problem	• The operational error of the fan motor of No. XXX indoor unit																	

1. How to diagnose
 - 1) Occurs when RPM valve fails to feedback to MICOM at a PID control-type fan motor

2. How to check
 - 1) Check HALL IC connector that carries out feedback of RPM value.
 - 2) If a fan motor operation capacitor is a PCB separating type, check the connection terminal.
 - 3) Check the operational status of the fan motor.
 - 4) If there is no problem with the above checkup items, replace the PCB.

4-4-16 Mixed operation Error (Only applicable to Heat Pump Model/Not to HR model)

- Mixed operation error is applicable only to Heat Pump Model and not to HR model.
- Mixed operation error is not due to a product problem but is displayed when the operational mode input in an indoor unit is different from current operational status (other indoor unit's operational mode).
- Check the operational mode of outdoor unit or other indoor unit then re-enter or stop the operational mode of the relevant unit.
- If it is necessary to apply a different operational mode to an indoor unit from others, please stop other indoor units then operate the indoor unit.

4-4-17 EEPROM error

Outdoor unit display	<i>E 162</i>																
Indoor unit display	Duct, Cassette (1 way / 2 way / Mini-4 way)				4 Way Cassette Type				Wall mounted Type				Circular Cassette Type				
	Display LED																
	1 way		or	or	Operation	Defroster	Timer	Filter	18 °C	21 °C	Reser- vation	24 °C	27 °C	Sky- Blue	Yellow- Green	Blue	Red
	Blue	Yellow- Green			Operation	Defroster	Timer	Filter	18 °C	21 °C	Reser- vation	24 °C	27 °C	Sky- Blue	Yellow- Green	Blue	Red
2 way		or	or	Operation	Defroster	Timer	Filter	18 °C	21 °C	Reser- vation	24 °C	27 °C	Sky- Blue	Yellow- Green	Blue	Red	
Green	Red			Operation	Defroster	Timer	Filter	18 °C	21 °C	Reser- vation	24 °C	27 °C	Sky- Blue	Yellow- Green	Blue	Red	
Criteria	• Communication failure between EEPROM and MICOM																
Cause of problem	• PCB replacement due to defective EEPROM																

1. How to check

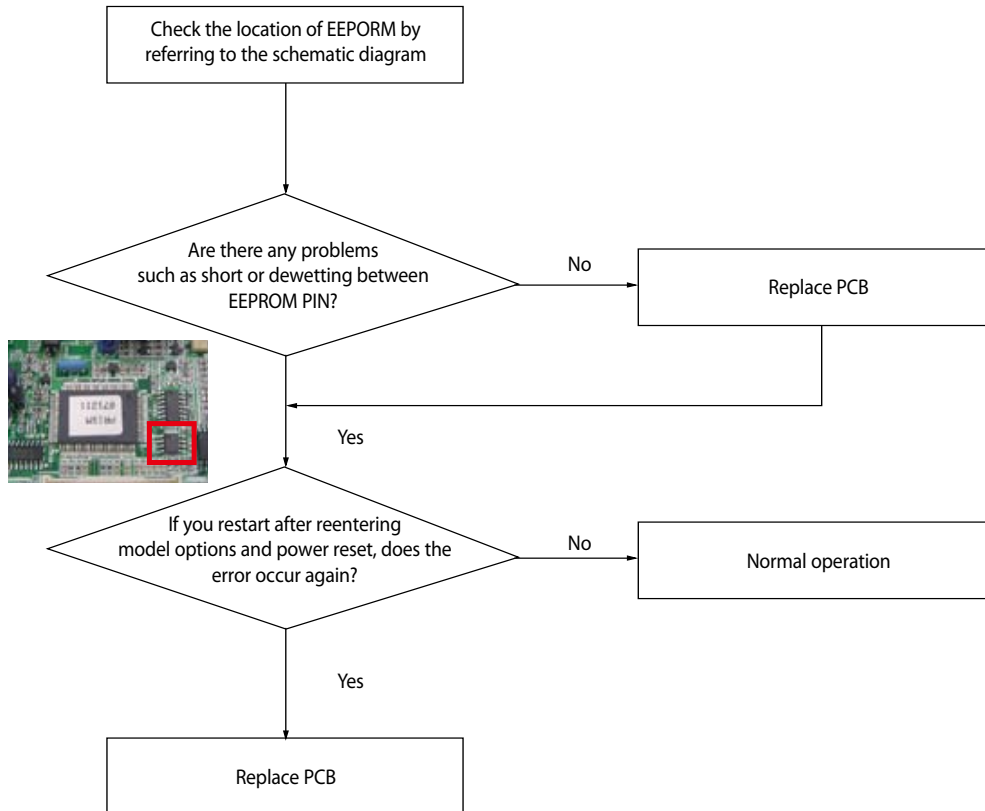

4-4-18 Option error of the Remote Controller for an Indoor Unit

Outdoor unit display	<i>E 163</i>																
Indoor unit display	Duct, Cassette (1 way / 2 way / Mini-4 way)				4 Way Cassette Type				Wall mounted Type				Circular Cassette Type				
	Display LED																
	1 way Blue Yellow-Green		or or	Operation		Defroster	Timer	Filter	18 °C	21 °C	Reser- vation	24 °C	27 °C	Sky- Blue	Yellow- Green	Blue	Red
	2 way Green Red			or	or	or	or	or	or	or	or	or	or	or	or	or	or
Criteria	• Display number type of indoor unit – E163 occurs, Lamp type – all lamps flash																
Cause of problem	• Missed or erroneous input of remote controller options																

- Check relevant remote controller options for each model then enter correct options

4-4-19 Error due to confused use of Fahrenheit and Celsius

Outdoor unit display	<i>E 170</i>															
Indoor unit display	×(Operation) ●(Timer) ●(Fan) ●(Filter) ×(Defrost)															
Criteria	<ul style="list-style-type: none"> • Display number type of indoor unit – E170 occurs, Lamp type – all lamps flash • Occurs in an indoor unit with Celsius setting 															
Cause of problem	• Missed input of remote controller options															

- Check relevant remote controller options for each model then enter correct options
- As this happens only in a Celsius setting model, it is necessary to reenter option codes for error-free models in a region where Celsius is used.

4-4-20 Simultaneous opening of Cooling/heating MCU SOL Valves 1st/2nd

- During the first detection, as the system restarts after making an automatic stop to check a problem with the system
- During the second detection, please refer to the following check-up methods.

1. How to check

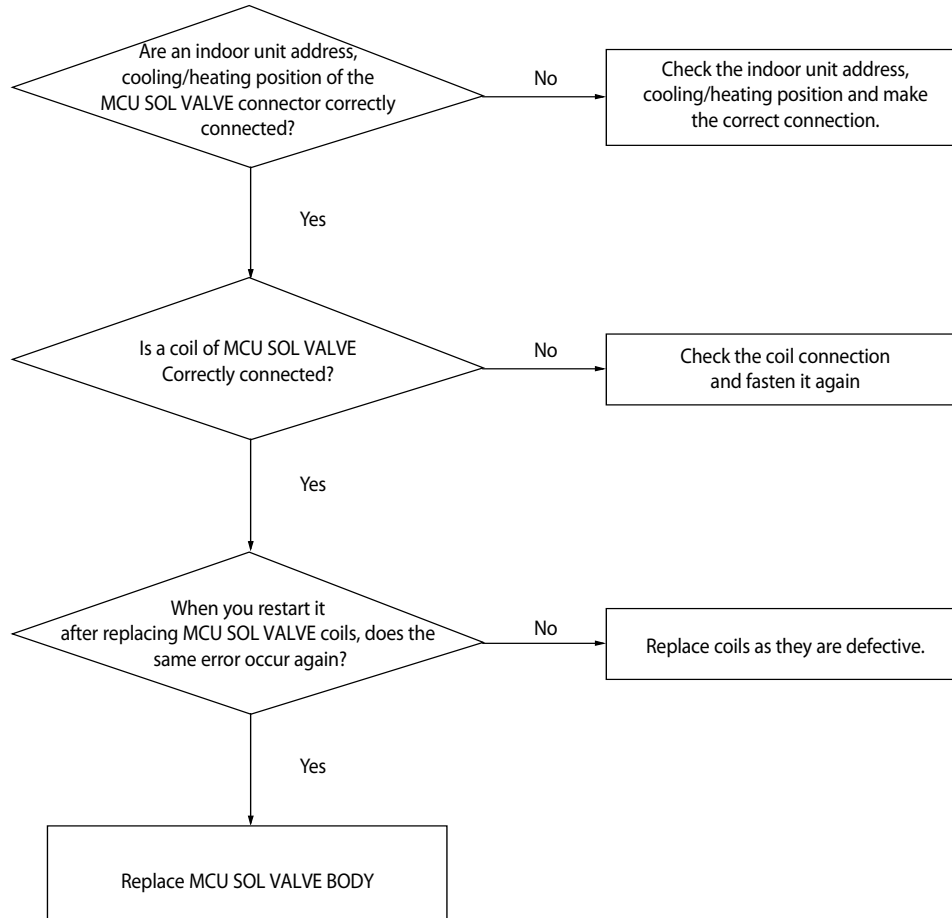

4-4-21 Error due to incorrect Indoor Unit Power/Communication Cable Connection

Outdoor unit display	<i>E 185</i>				
Indoor unit display	Wall mount				
	LED Displays				
	18 °C	21 °C	Reservation	24 °C	27 °C
	×	×	●	●	×
Criteria	• Check for Power input(220V) for the Terminal block(F1/F2).				
Cause of problem	• Apply power (220V) to the terminal of the indoor unit communication block (F1/F2)				

- Check for disconnected line after turning off the Main power.

4-4-22 SPI Feedback Error

Outdoor unit display	<i>E 186</i>
Indoor unit display	●(Operation) ●(Timer) ×(Fan) ●(Filter) ×(Defrost)
Criteria	• Check if the output of SPI Feedback is 12V
Cause of problem	• SPI defect

1. How to check

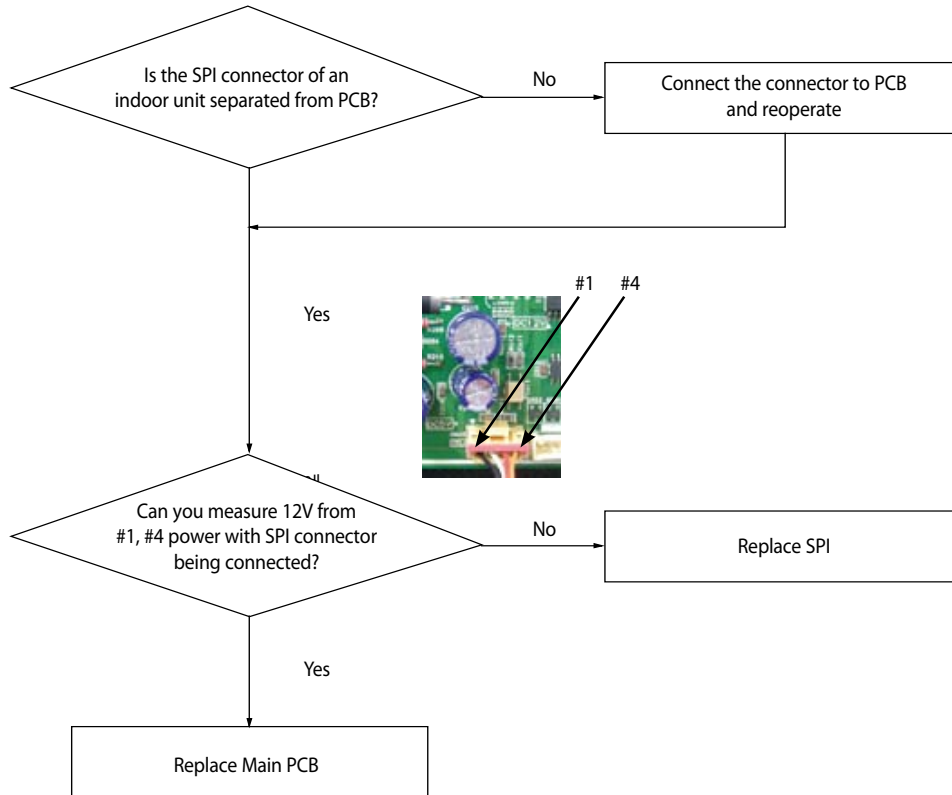

4-4-23 Outdoor Unit Pipe Inspection Error

Outdoor unit display	<i>E 190</i> : No change of EVA IN or wrong EVAN IN change during pipe inspection. <i>E 191</i> : No change of EVA OUT or wrong EVA OUT change during pipe inspection.
Indoor unit display	-
Criteria	• Refer to the judgment method below
Cause of problem	• The liquid pipe/gas pipe of the indoor unit is not correctly connected to the port set in MCU.

1. Judgment Method

- Check if the indoor address settings are the same for the address of the indoor units connected to each port of the MCU and the address of the indoor units of the relevant MCU ports.
- Check if the indoor unit usage setup switch is turned on for the MCU port connected to the indoor unit.

4-4-24 Communication Error between Indoor and Outdoor Units during Tracking

Outdoor unit display	E201																
Indoor unit display	Duct, Cassette (1 way / 2 way / Mini-4 way)				4 Way Cassette Type				Wall mounted Type				Circular Cassette Type				
	Display LED																
	1 way Blue Yellow-Green		or or	or or	Operation	Defroster	Timer	Filter	18 °C	21 °C	Reser- vation	24 °C	27 °C	Sky- Blue	Yellow- Green	Blue	Red
	2 way Green Red				⏻	⏻	⏻	⏻	⏻	⏻	⏻	⏻	⏻	⏻	⏻	⏻	⏻
X	X	●	●	X	X	●	●	X	X	●	●	X	X	●	X	X	
Criteria	· Communication error between indoor and outdoor units.																
Cause of problem	· Refer to the judgment method below.																

1. Cause of problem

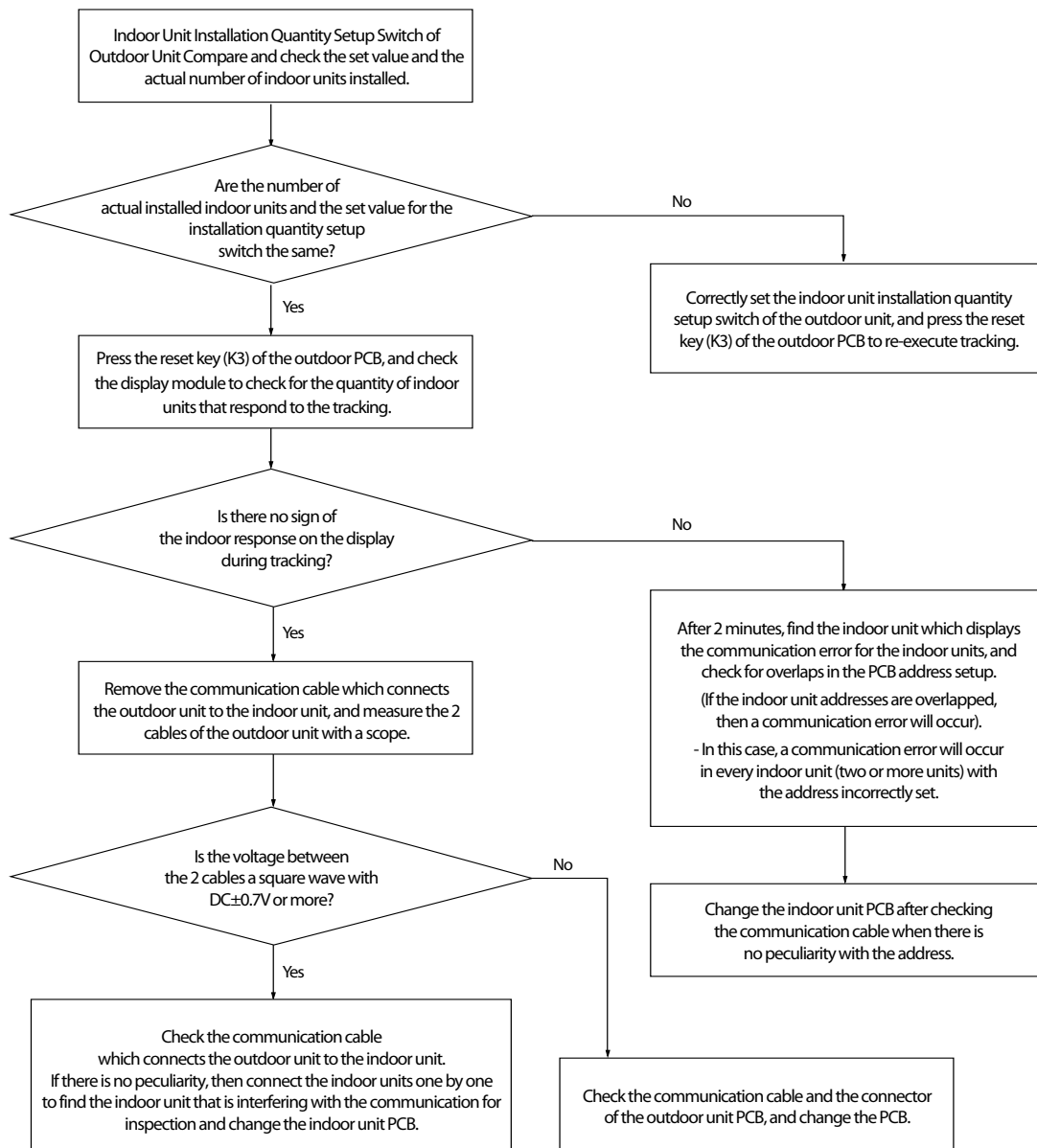

4-4-25 Communication Error between Indoor and Outdoor Units after Tracking

Outdoor unit display	E202																				
Indoor unit display	Duct, Cassette (1 way / 2 way / Mini-4 way)				4 Way Cassette Type				Wall mounted Type				Circular Cassette Type								
	Display LED																				
	1 way	Blue	Yellow-Green	2 way	Green	Red	or	or	Operation	Defroster	Timer	Filter	18 °C	21 °C	Reser- -vation	24 °C	27 °C	Sky- -Blue	Yellow- -Green	Blue	Red
	X	X	●	●	X	X	●	●	X	X	X	X	X	X	●	●	X	X	●	X	X
Criteria	· Outdoor unit is unable to communicate for two minutes during operation. (no reception of relocation)																				
Cause of problem	· Communication error between indoor and outdoor units and setup error of indoor unit installation quantity setup switch.																				

1. Cause of problem

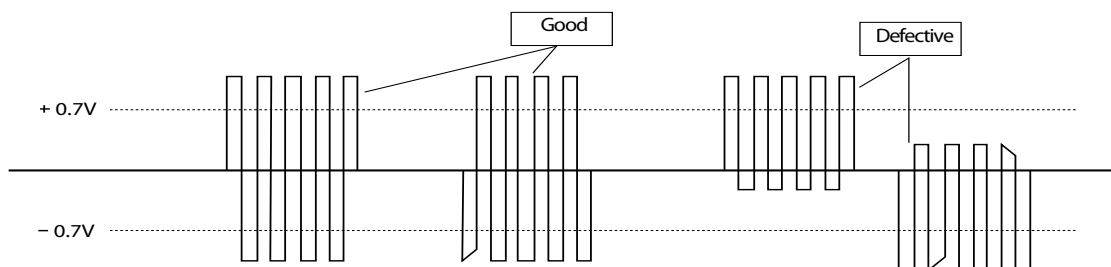
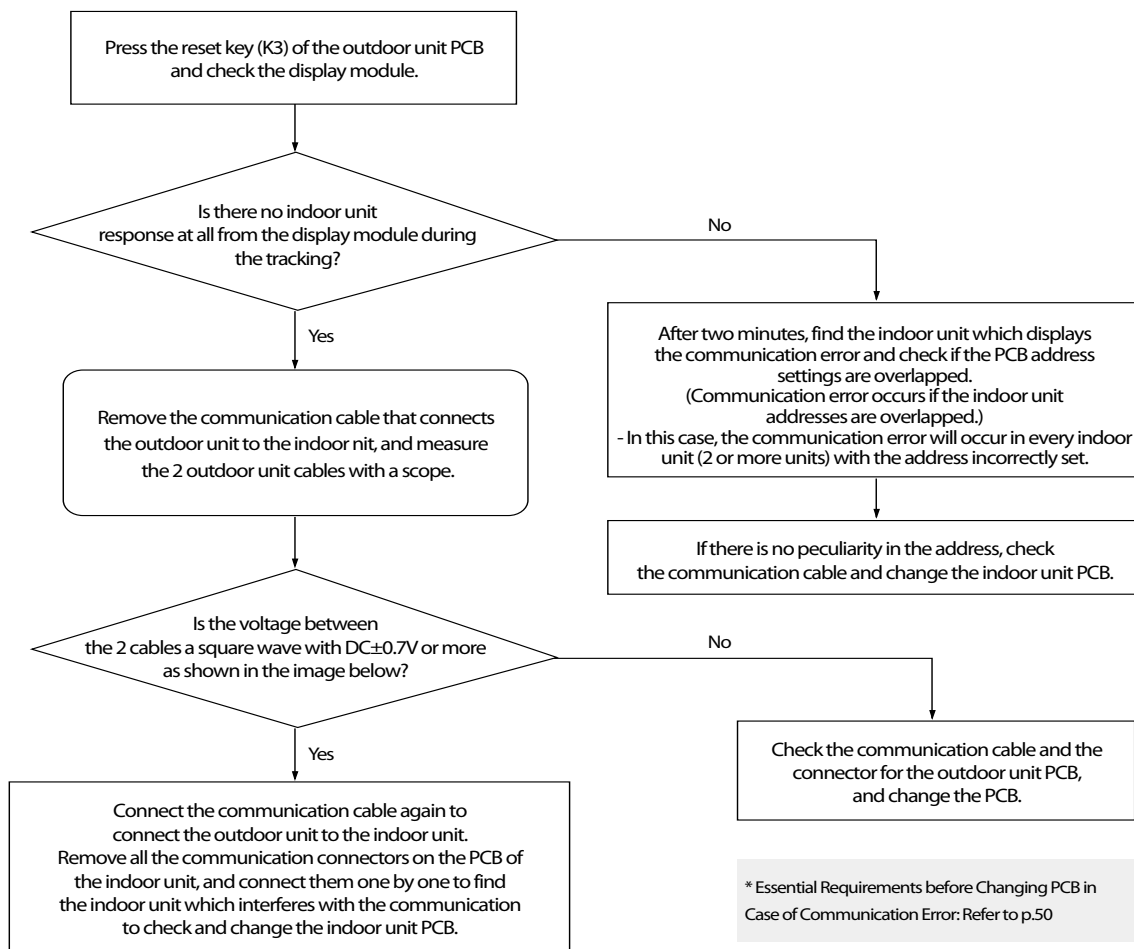

4-4-26 Communication error between main and sub Unit of outdoor unit or between outdoor units

Outdoor unit display	E203																
Indoor unit display	Duct, Cassette (1 way / 2 way / Mini-4 way)				4 Way Cassette Type				Wall mounted Type				Circular Cassette Type				
	Display LED																
	1 way Blue Yellow-Green		or or	or or	Operation	Defroster	Timer	Filter	18 °C	21 °C	Reser- vation	24 °C	27 °C	Sky -Blue	Yellow -Green	Blue	Red
	2 way Green Red				⏻	⏻	⏻	⏻	⏻	⏻	⏻	⏻	⏻	⏻	⏻	⏻	⏻
×	×	●	●	×	×	●	●	×	×	●	●	×	×	●	×	×	

Criteria · Refer to the judgment method below.

Cause of problem · Communication error between outdoor units.

1. Cause of problem

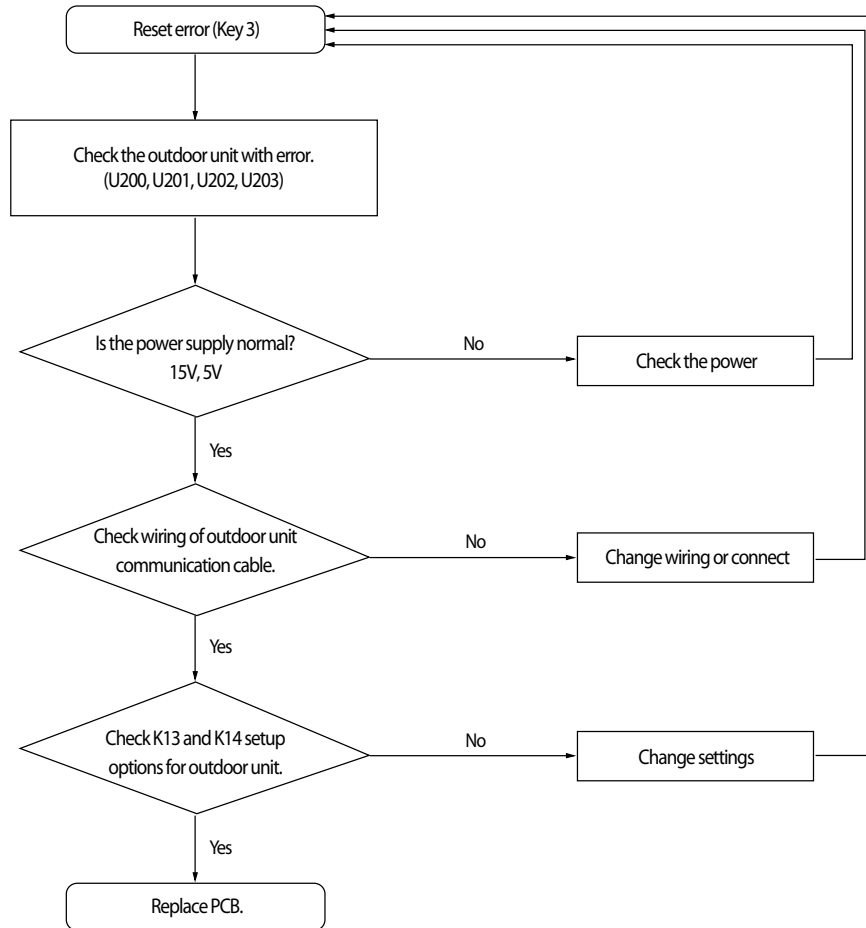

Essential Requirements before Changing PCB in Case of Communication Error: Refer to p.59

4-4-27 Communication Error between MCU and Outdoor Unit

Outdoor unit display	E204
Indoor unit display	
Criteria	• Communication Error between MCU and outdoor unit
Cause of problem	• Reference below

1. Inspection Method

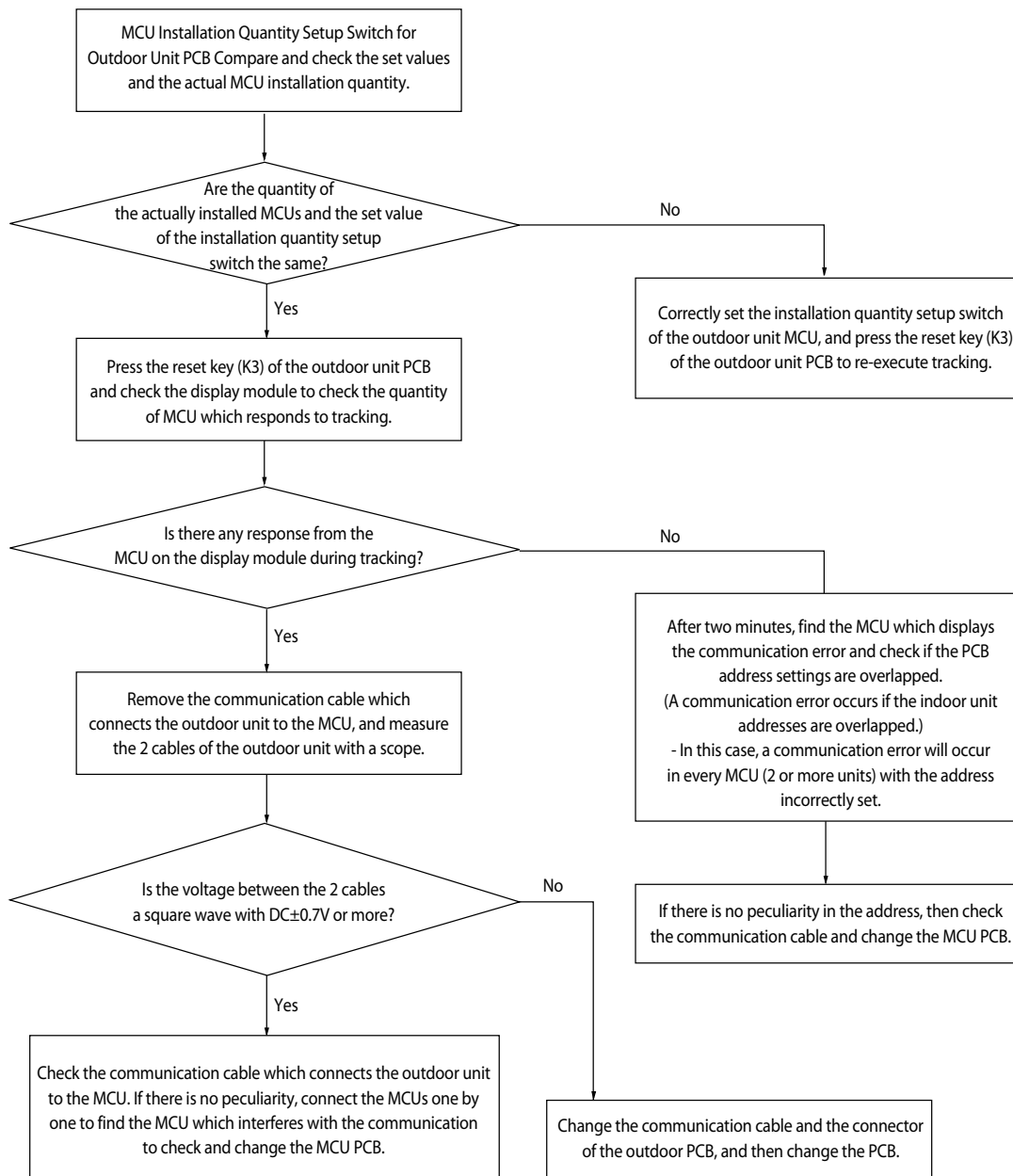

※ Essential Requirements before Changing PCB in Case of Communication Error: Refer to p.4-80

4-4-28 Internal Communication error of the Outdoor Unit C-Box

Outdoor unit display	E205																				
Indoor unit display	Duct, Cassette (1 way / 2 way / Mini-4 way)				4 Way Cassette Type				Wall mounted Type				Circular Cassette Type								
	Display LED																				
	1 way	Blue	Yellow-Green	2 way	Green	Red	or	or	Operation	Defroster	Timer	Filter	18 °C	21 °C	Reser- vation	24 °C	27 °C	Sky- Blue	Yellow- Green	Blue	Red
	×	×	●	●	×	×	●	●	×	×	×	×	×	×	●	●	×	×	●	×	×
Criteria	· Communication error between the C-Box PCB																				
Cause of problem	· Communication wire inside the C-Box is unconnected · Main PCB defective																				

1. Cause of problem

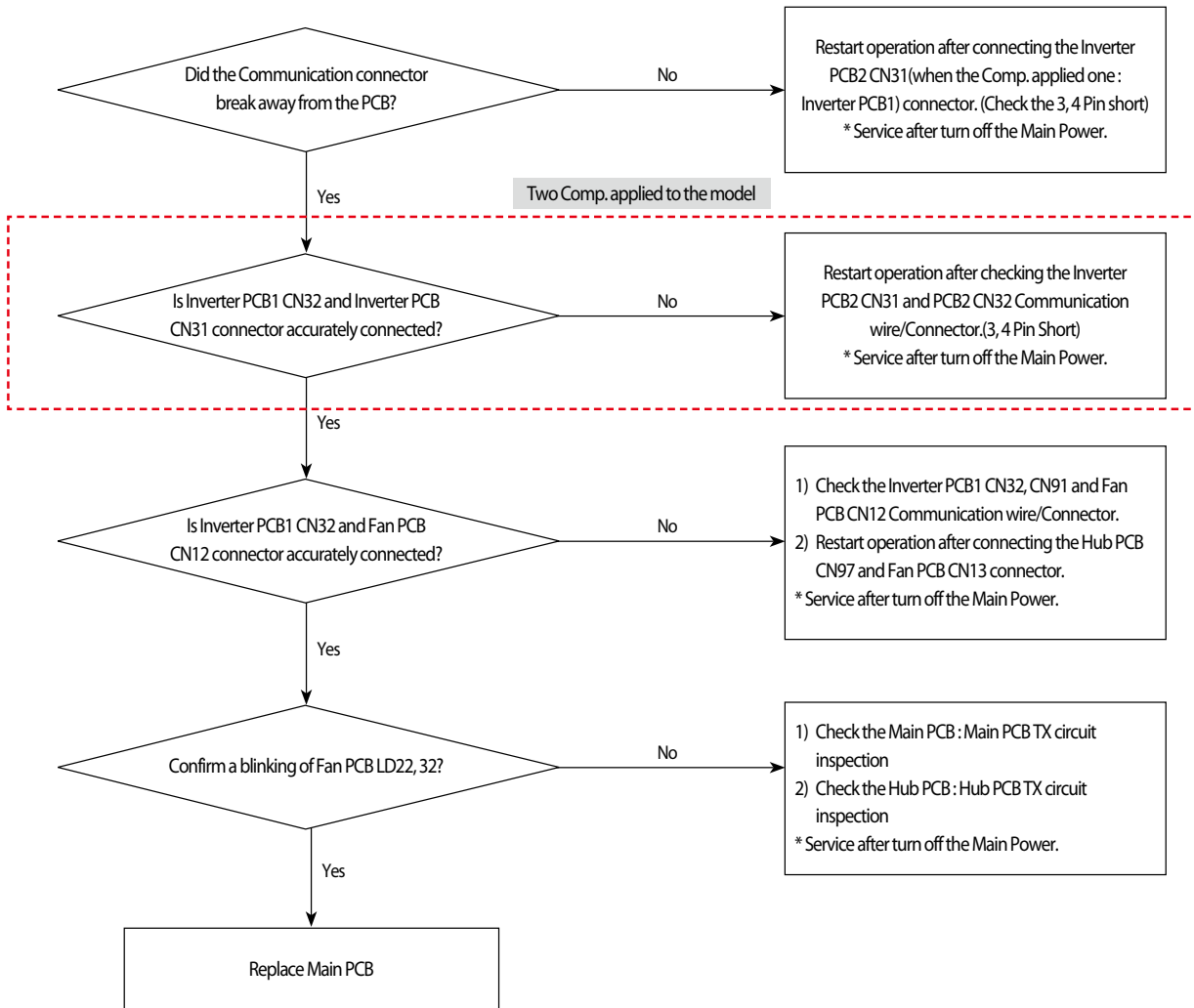

4-4-29 Internal PCB Communication error of the Outdoor Unit C-Box

Outdoor unit display	E206																
Indoor unit display	Duct, Cassette (1 way / 2 way / Mini-4 way)				4 Way Cassette Type				Wall mounted Type				Circular Cassette Type				
	Display LED																
	1 way Blue Yellow-Green		or or	or or	Operation	Defroster	Timer	Filter	18 °C	21 °C	Reser- vation	24 °C	27 °C	Sky- Blue	Yellow- Green	Blue	Red
	2 way Green Red				⏻	⏻	⏻	⏻	⏻	⏻	⏻	⏻	⏻	⏻	⏻	⏻	⏻
X	X	●	●	X	X	●	●	X	X	●	●	X	X	●	X	X	
Criteria	· PCB does not respond to the invoked Main PCB																
Cause of problem	· C-Box internal Inverter PCB, Fan PCB, Hub PCB defective																

1. Cause of problem

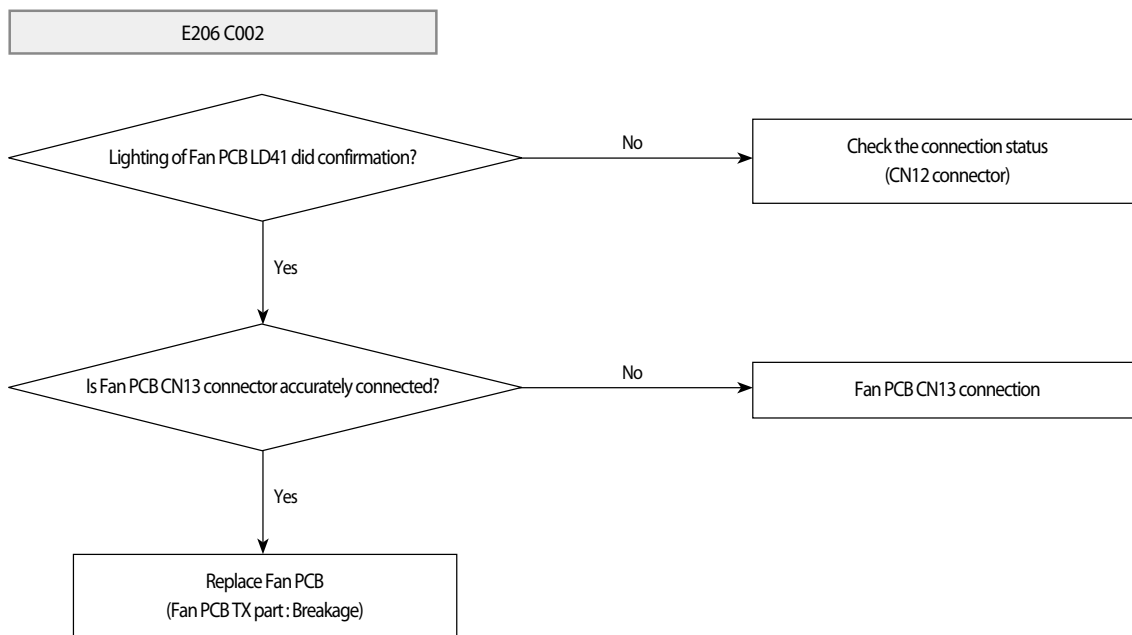
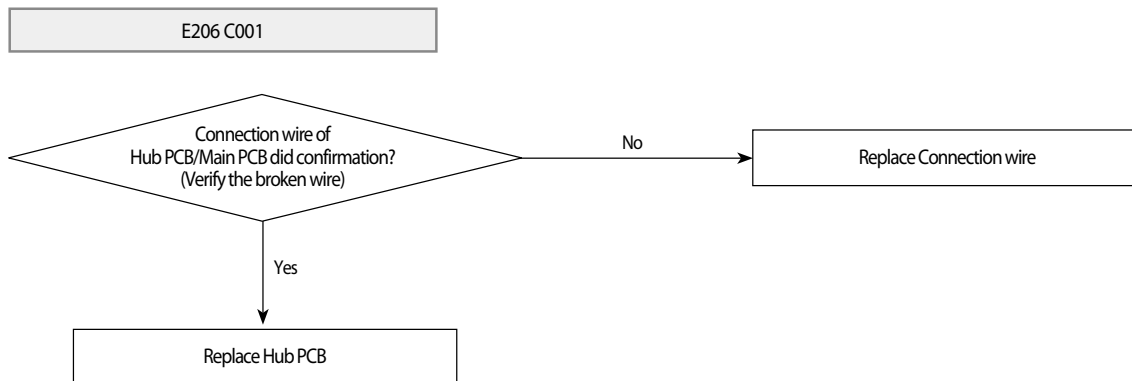

4-4-30 Communication Error between MCU and Outdoor Unit after Tracking is Completed

Outdoor unit display	<i>E2 10</i>
Indoor unit display	
Criteria	• Outdoor unit is unable to communicate for two or more minutes during operation (no reception of relocation)
Cause of problem	• Communication error between indoor and outdoor units and setup error of indoor unit installation quantity setup switch

1. Inspection Method

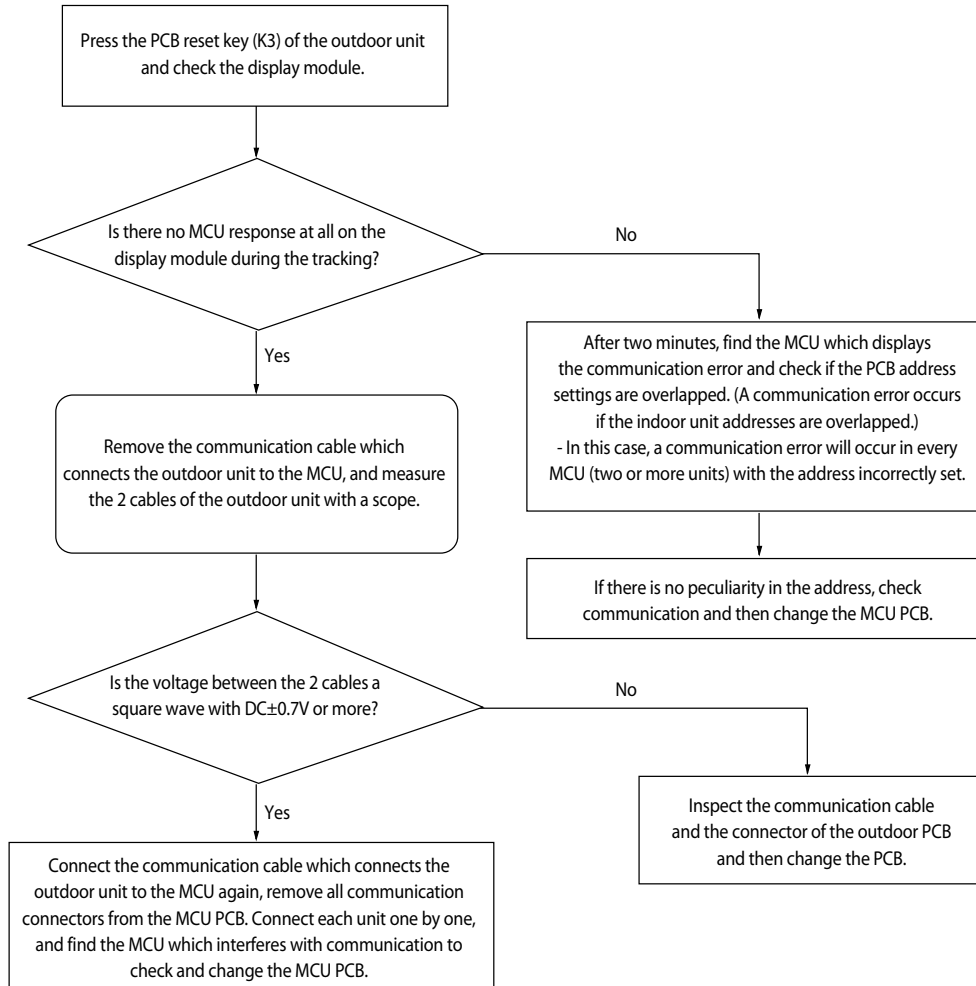

* Essential Requirements before Changing PCB in Case of Communication Error: Refer to p.4-80

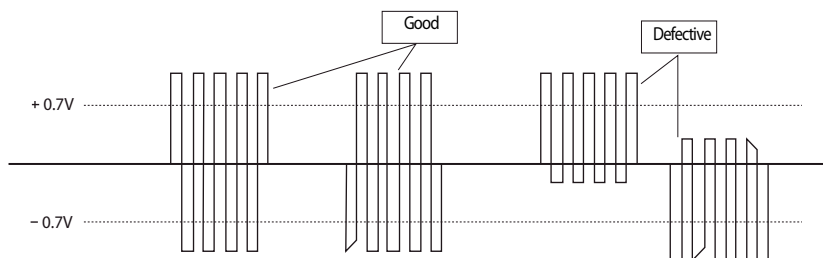

4-4-31 MCU branch part setup error – inconsecutive connection with the use of 2 branch parts

Outdoor unit display	E211																
Indoor unit display	Duct, Cassette (1 way / 2 way / Mini-4 way)				4 Way Cassette Type				Wall mounted Type				Circular Cassette Type				
	Display LED																
	1 way Blue Yellow-Green		or or	or or	Operation	Defroster	Timer	Filter	18 °C	21 °C	Reser- -vation	24 °C	27 °C	Sky- -Blue	Yellow- -Green	Blue	Red
	2 way Green Red				●	●	×	×	●	●	×	×	●	●	×	×	●
Criteria		• When 2 branch parts are used for one indoor unit without connecting them consecutively.															
Cause of problem		• Branch part assembly error															

1. How to check

Find an MCU that is composed as the following picture to carry out assembly of branch part again. After completing the re-setting, press K3 button on the button to reset or turn it off to restart.

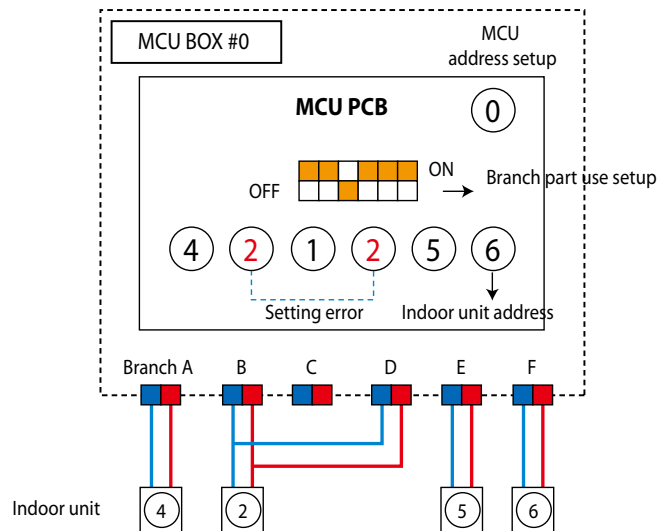

4-4-32 MCU branch part setup error – Repeated setup for the same address over 3 times

Outdoor unit display	E2 12															
Indoor unit display	Duct, Cassette (1 way / 2 way / Mini-4 way)				4 Way Cassette Type				Wall mounted Type				Circular Cassette Type			
	Display LED															
	1 way Blue Yellow-Green		or or	Operation	Defroster	Timer	Filter	18 °C	21 °C	Reser- vation	24 °C	27 °C	Sky- Blue	Yellow- Green	Blue	Red
	2 way Green Red			⏻	⏻	⏻	⏻	⏻	⏻	⏻	⏻	⏻	⏻	⏻	⏻	⏻
×	×	●	●	×	×	●	●	×	×	×	●	●	×	×	×	
Criteria	• The same indoor unit address was setup more than 3 times in MCU.															
Cause of problem	• MCU indoor unit address setting error.															

1. How to check

Find an MCU that is composed as the following picture to carry out assembly of branch part again. After completing the re-setting, press K3 button on the button to reset or turn it off to restart.

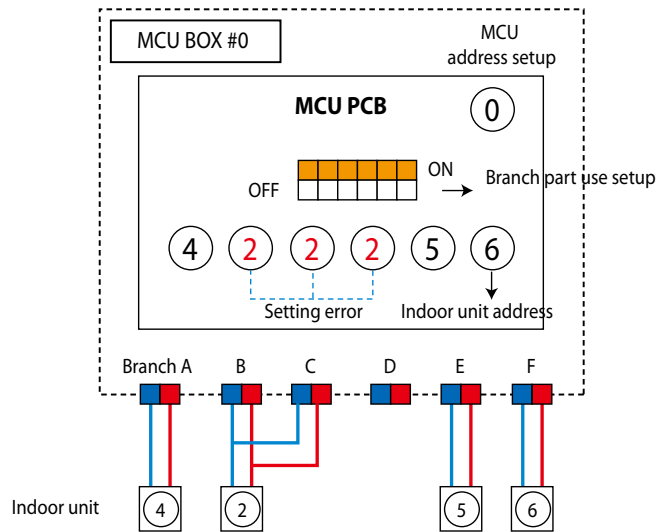

4-4-33 MCU branch part setup error – non-installed address setup

Outdoor unit display	E213																			
Indoor unit display	Duct, Cassette (1 way / 2 way / Mini-4 way)				4 Way Cassette Type				Wall mounted Type				Circular Cassette Type							
	Display LED																			
	1 way	Blue	Yellow-Green	2 way	Green	Red	or	or	Operation	Defroster	Timer	Filter	18 °C	21 °C	Reser- vation	24 °C	27 °C	Sky- Blue	Yellow- Green	Blue
×	×	○	○	×	×	○	○	×	×	○	○	×	×	○	○	×	×	○	×	×
Criteria	• If there is an indoor unit that is not installed among MCU registered indoor units																			
Cause of problem	• Indoor unit, with the assigned address on MCU, not installed.																			

1. How to check

Find an MCU that is composed as the following picture to carry out assembly of branch part again. After completing the re-setting, press K3 button on the button to reset or turn it off to restart.

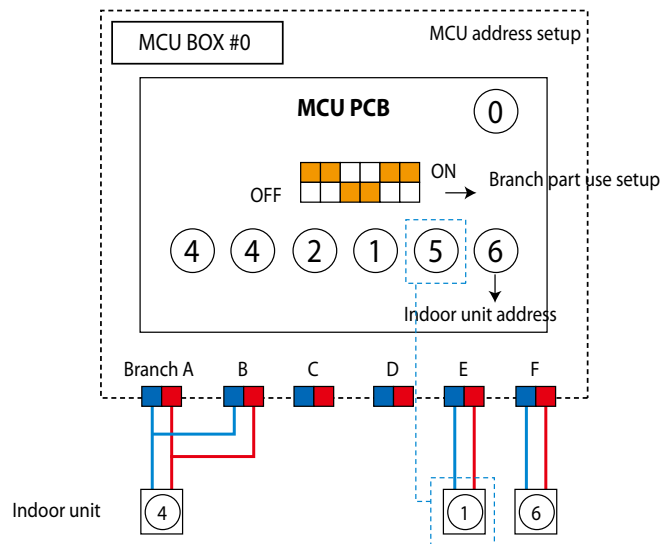

4-4-34 Setup Error for MCU Branch part – Setup Error for MCU Quantity Used

Outdoor unit display	E2 14																			
Indoor unit display	Duct, Cassette (1 way / 2 way / Mini-4 way)				4 Way Cassette Type				Wall mounted Type				Circular Cassette Type							
	Display LED																			
	1 way	Blue	Yellow-Green	Green	Red	or	or	Operation	Defroster	Timer	Filter	18 °C	21 °C	Reser- vation	24 °C	27 °C	Sky- Blue	Yellow- Green	Blue	Red
2 way	Green	Red																		
	X	X	●	●	X	X	●	●	X	X	X	X	●	●	X	X	●	X	X	X
Criteria	<ul style="list-style-type: none"> Occurs when the quantity of MCU is incorrectly set by the outdoor unit. Occurs when same addresses are found when two or more MCU are connected. 																			
Cause of problem	Outdoor unit MCU setup and same address errors when connecting two or more MCUs .																			

1. Inspection Method : Re-check the MCU quantity setup switch from the outdoor unit.

Check for overlaps in each MCU address setup switch.

To use, reset by pressing the K3 button of the outdoor unit after the reset is completed, or reset after turning off the power and then turn it on again.

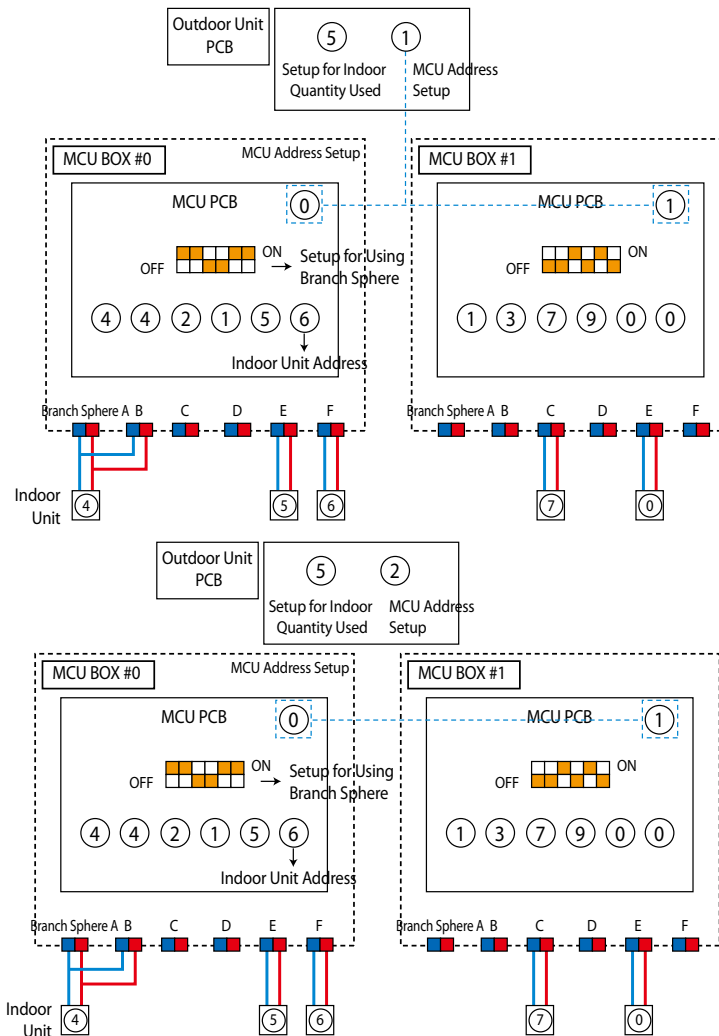

4-4-35 MCU branch part setup error – Overlapping Indoor unit Address setup

Outdoor unit display	E2 15																			
Indoor unit display	Duct, Cassette (1 way / 2 way / Mini-4 way)				4 Way Cassette Type				Wall mounted Type				Circular Cassette Type							
	Display LED																			
	1 way	Blue	Yellow-Green	Green	Red	or	or	Operation	Defroster	Timer	Filter	18 °C	21 °C	Reser- vation	24 °C	27 °C	Sky- Blue	Yellow- Green	Blue	Red
2 way	Green	Red																		
	X	X	●	●	X	X	●	●	X	X	X	X	●	●	X	X	●	X	X	X
Criteria	• Occurs when an indoor unit address setup switch in MCU has been overlapped																			
Cause of problem	• Repeated indoor unit address																			

1. How to check

Check the setup switch for the number of indoor units in MCU

After completing resetting, press the outdoor unit's K3 button to reset or turn off to restart.

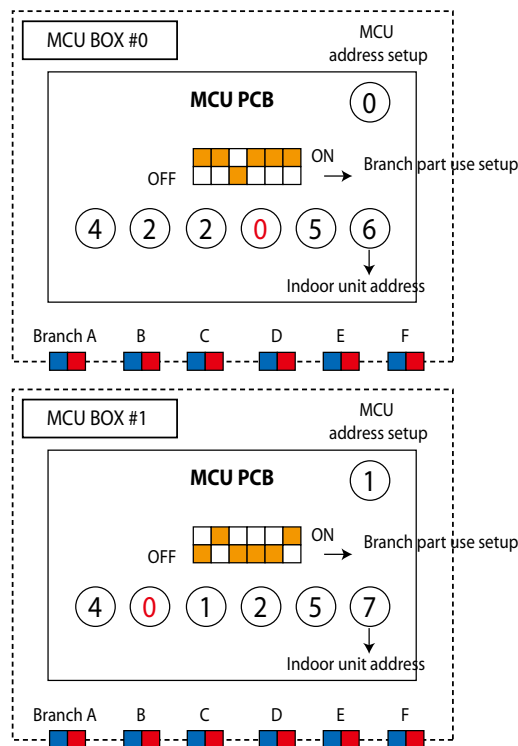

4-4-36 MCU branch part setup error – Set as being used without connection to an Indoor unit

Outdoor unit display	E2 16																
Indoor unit display	Duct, Cassette (1 way / 2 way / Mini-4 way)				4 Way Cassette Type				Wall mounted Type				Circular Cassette Type				
	Display LED																
	1 way		or	or	Operation	Defroster	Timer	Filter	18 °C	21 °C	Reser- vation	24 °C	27 °C	Sky- Blue	Yellow- Green	Blue	Red
	Blue	Yellow- Green			⏻	⏻	⏻	⏻	⏻	⏻	⏻	⏻	⏻	⏻	⏻	⏻	⏻
2 way		or	or	⏻	⏻	⏻	⏻	⏻	⏻	⏻	⏻	⏻	⏻	⏻	⏻	⏻	
Green	Red			⏻	⏻	⏻	⏻	⏻	⏻	⏻	⏻	⏻	⏻	⏻	⏻	⏻	⏻
Criteria	• Occurs when MCU PIPE is set as being used, yet not connected to an indoor unit																
Cause of problem	• Pipe is not installed to the indoor unit with assigned address on MCU																

1. How to check

Adjust the Dip switch that sets up the use of MCU branch part to 'Not-Used'. After completing resetting, press the outdoor unit's K3 button to reset or turn off to restart.

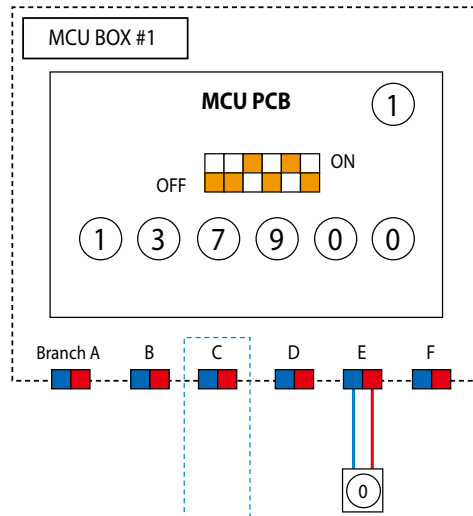

4-4-37 MCU branch part setup error – Connect an Indoor unit to a branch part not being used

Outdoor unit display	E2 17																
Indoor unit display	Duct, Cassette (1 way / 2 way / Mini-4 way)				4 Way Cassette Type				Wall mounted Type				Circular Cassette Type				
	Display LED																
	1 way Blue	Yellow-Green	or	or	Operation	Defroster	Timer	Filter	18 °C	21 °C	Reser- -vation	24 °C	27 °C	Sky- -Blue	Yellow- -Green	Blue	Red
	2 way Green	Red															
	X	X	●	●	X	X	●	●	X	X	●	●	X	X	●	X	X
Criteria	• Occurs when MCU PIPE is set as being used, yet not connected to an indoor unit																
Cause of problem	• Pipe is not installed to the indoor unit with assigned address on MCU																

1. How to check

Check the actual use of the branch part. If it is used, turn on the Dip switch for branch part setup. After completing resetting, press the outdoor unit's K3 button to reset or turn off to restart.

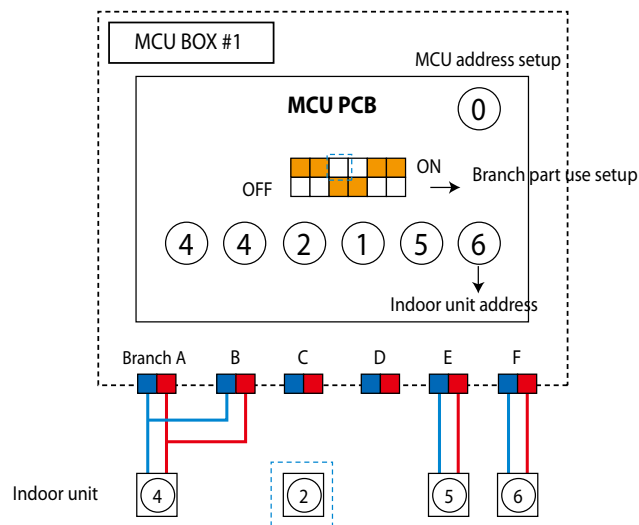

4-4-38 MCU branch part setup error – Connect more Indoor units than what is actually set up in MCU

Outdoor unit display	E2 18																				
Indoor unit display	Duct, Cassette (1 way / 2 way / Mini-4 way)				4 Way Cassette Type				Wall mounted Type				Circular Cassette Type								
	Display LED																				
	1 way	Blue	Yellow-Green	2 way	Green	Red	or	or	Operation	Defroster	Timer	Filter	18 °C	21 °C	Reser- vation	24 °C	27 °C	Sky- Blue	Yellow- Green	Blue	Red
	○	○	○	○	○	○	○	○	○	○	○	○	○	○	○	○	○	○	○	○	○
Criteria	• Occurs when the number of indoor units installed exceeds that registered in MCU																				
Cause of problem	• Number of indoor units exceeds number of indoor units entered on MCU setting.																				

1. How to check

Check the number of indoor units connected to MCU then readjust the switch for the number of units

After completing resetting, press the outdoor unit's K3 button to reset or turn off to restart.

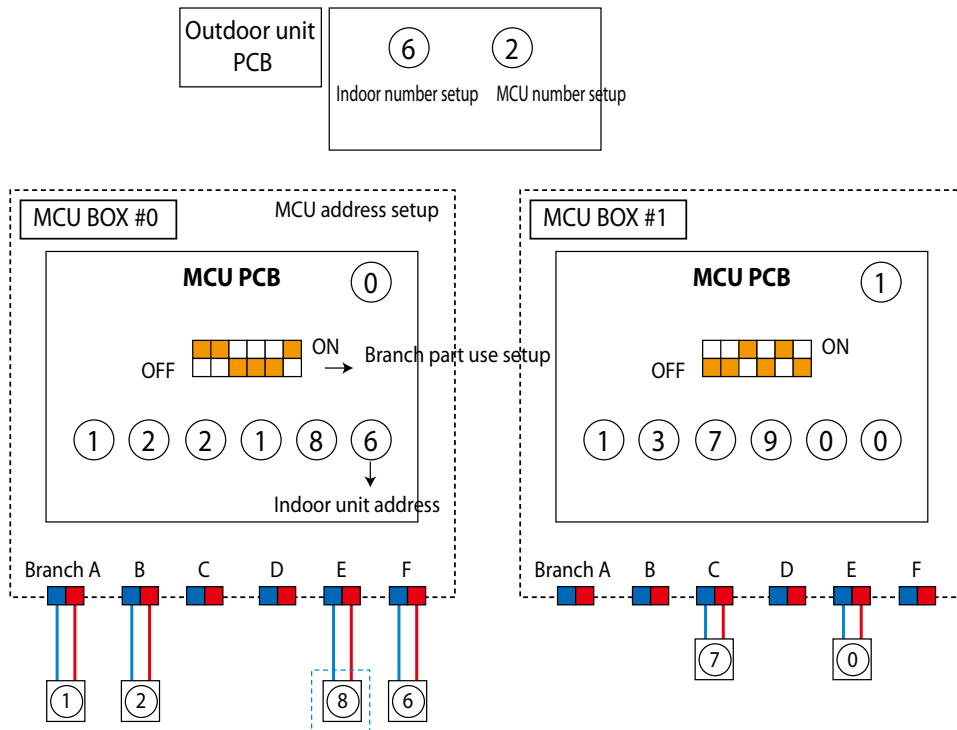

4-4-39 Outdoor Temperature Sensor Error

Outdoor unit display	E221																
Indoor unit display	Duct, Cassette (1 way / 2 way / Mini-4 way)				4 Way Cassette Type				Wall mounted Type				Circular Cassette Type				
	Display LED																
	1 way Blue Yellow-Green		or or	Operation		Defroster	Timer	Filter	18 °C	21 °C	Reser- -vation	24 °C	27 °C	Sky- -Blue	Yellow- -Green	Blue	Red
	2 way Green Red			or	or	or	or	or	or	or	or	or	or	or	or	or	or
● ×		×	●	×	●	×	●	×	●	×	●	×	●	×	●	×	

Criteria · Refer to the judgment method below.
Cause of problem · Outdoor temperature sensor Open/Short is defective.

1. Cause of problem

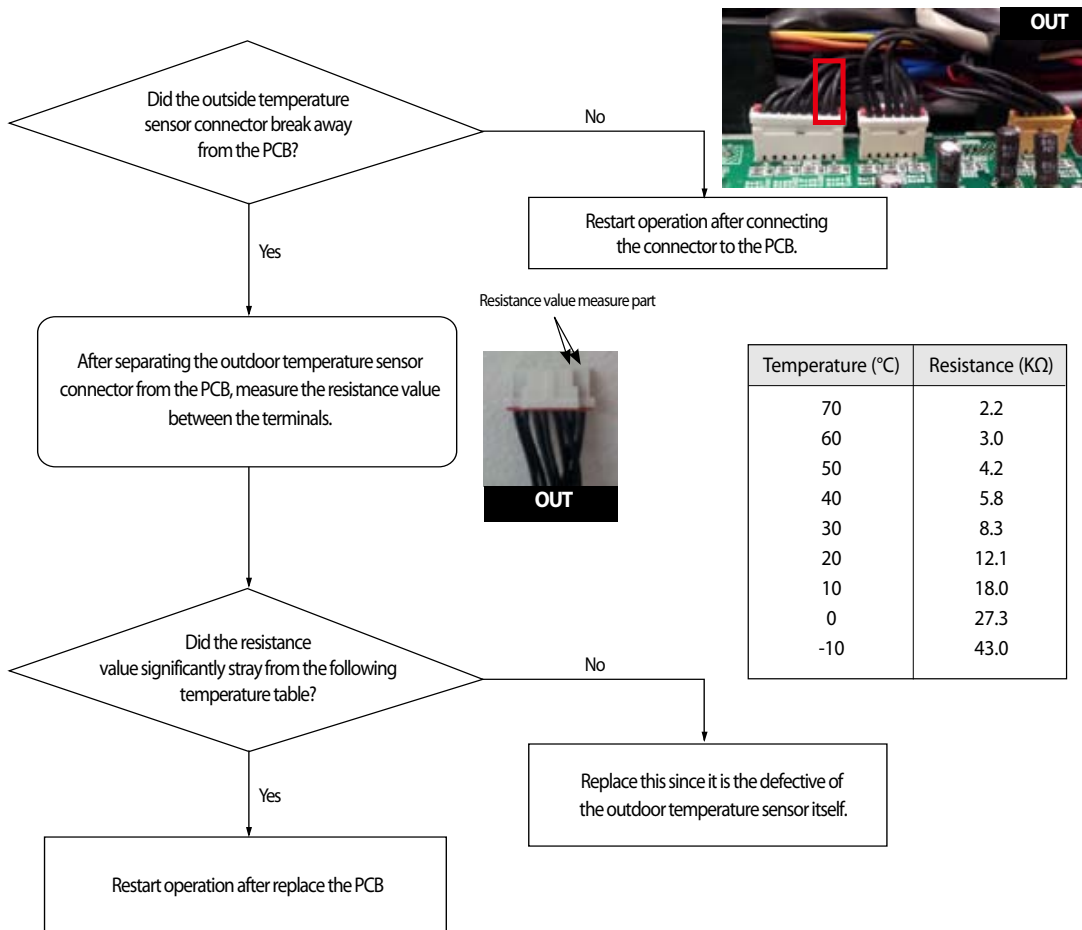

4-4-40 Outdoor Temperature dislocation error

1. How to check

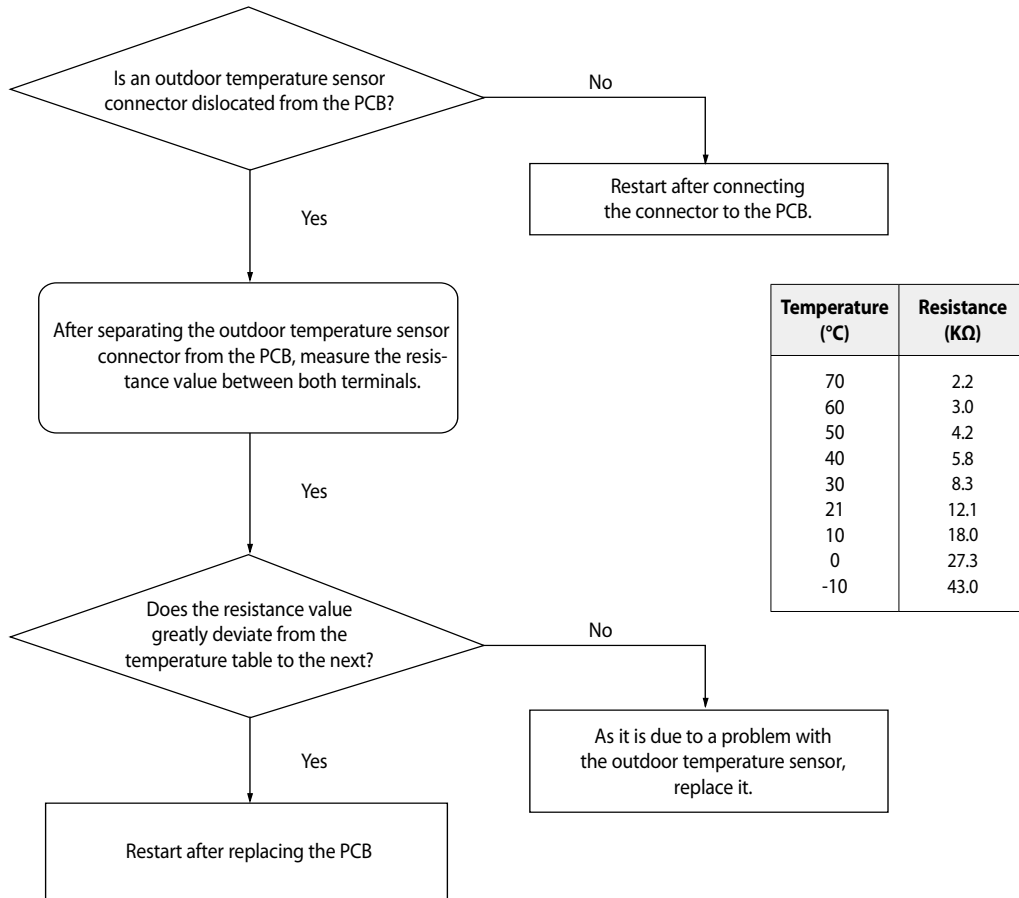

4-4-41 Cond Out Temperature Sensor Error (Open/Short)

Outdoor unit display	E231																				
Indoor unit display	Duct, Cassette (1 way / 2 way / Mini-4 way)				4 Way Cassette Type				Wall mounted Type				Circular Cassette Type								
	Display LED																				
	1 way	Blue	Yellow-Green	2 way	Green	Red	or	or	Operation	Defroster	Timer	Filter	18 °C	21 °C	Reser- -vation	24 °C	27 °C	Sky- -Blue	Yellow- -Green	Blue	Red
	○	×	×	○	×	×	○	×	○	×	○	×	○	×	×	○	×	×	○	×	×
Criteria	· Refer to the judgment method below.																				
Cause of problem	· Disconnection or breakdown of relevant sensor.																				

1. Cause of problem

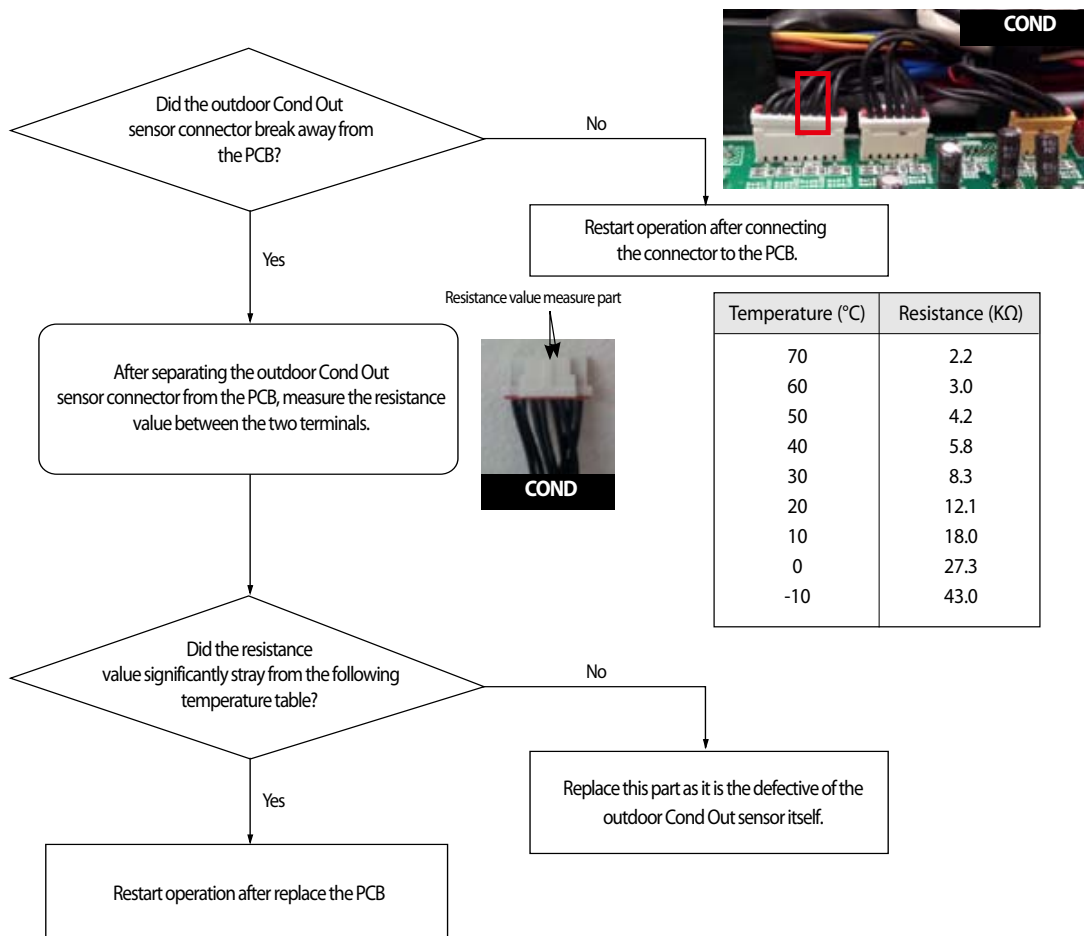

4-4-42 Outdoor Cond Out sensor breakaway error

Outdoor unit display	E241																		
Indoor unit display	Duct, Cassette (1 way / 2 way / Mini-4 way)				4 Way Cassette Type				Wall mounted Type				Circular Cassette Type						
	Display LED																		
	1 way		Blue	Yellow-Green	or	or	Operation	Defroster	Timer	Filter	18 °C	21 °C	Reser- vation	24 °C	27 °C	Sky- Blue	Yellow- Green	Blue	Red
	2 way						Green	Red	or	or	or	or	or	or	or	or	or	or	or
X	X	●	●	●	X	●	●	●	●	X	X	●	●	●	X	X	●	X	

Criteria · Refer to the judgment method below.

Cause of problem · Outdoor Cond Out sensor breakaway/defective/ relevant path blocked.

1. Judgment Method

- 1) No inspection for Cooling operation.
- 2) For heating operation (Each of the conditions below needs to be satisfied for more than 20 minutes.)

High pressure average > 25kg/cm ²	OK
Low pressure average < 8.5kg/cm ²	OK
Teva, out - Tair, in ≥ 3°C	OK
Teva, in - Tair, in ≥ 2°C	OK
Tcond, out - Tair, out ≤ 0°C	NO
Every compressor is in operation & indoor unit operation and Thermo On	OK
Error Content	Outdoor Cond Out sensor breakaway error

2. Cause of problem

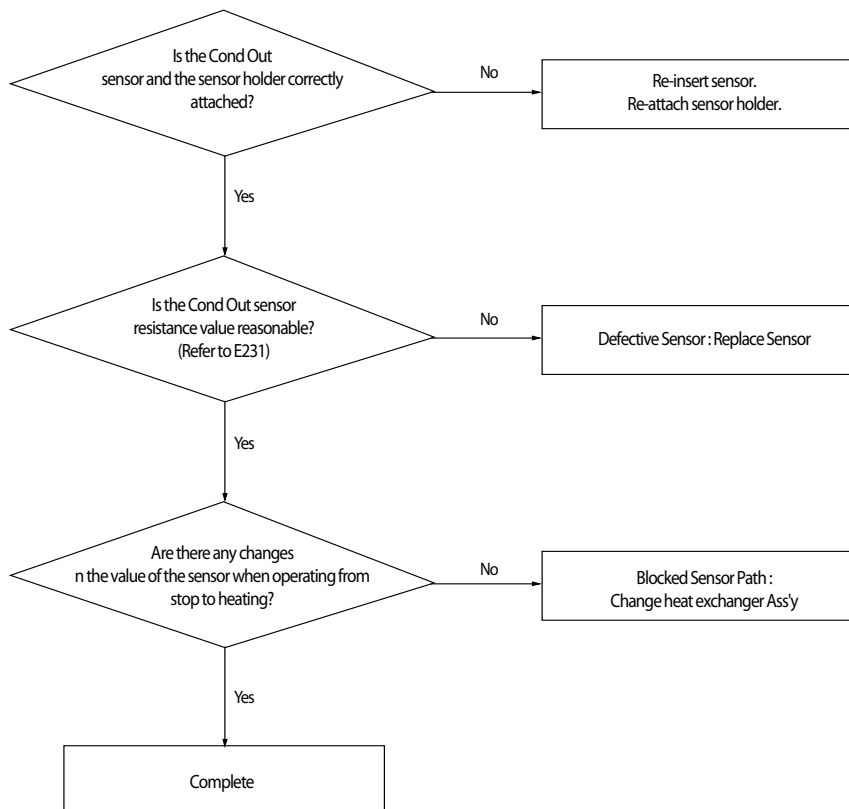

4-4-43 Digital Compressor Discharge Temperature Sensor Error (OPEN/SHORT)

Outdoor unit display	E251																	
Indoor unit display	Duct, Cassette (1 way / 2 way / Mini-4 way)				4 Way Cassette Type				Wall mounted Type				Circular Cassette Type					
	Display LED																	
	1 way Blue Yellow-Green		or	or		Operation	Defroster	Timer	Filter	18 °C	21 °C	Reser- -vation	24 °C	27 °C	Sky- -Blue	Yellow- -Green	Blue	Red
	2 way Green Red			or	or	or	or	or	or	or	or	or	or	or	or	or	or	or
●	×	×	●	×	●	×	●	×	●	×	×	●	×	×	×	●	×	

Criteria • Refer to the inspection method below,
Cause of problem • Digital compressor discharge temperature sensor OPEN/SHORT problem

1. Inspection Method

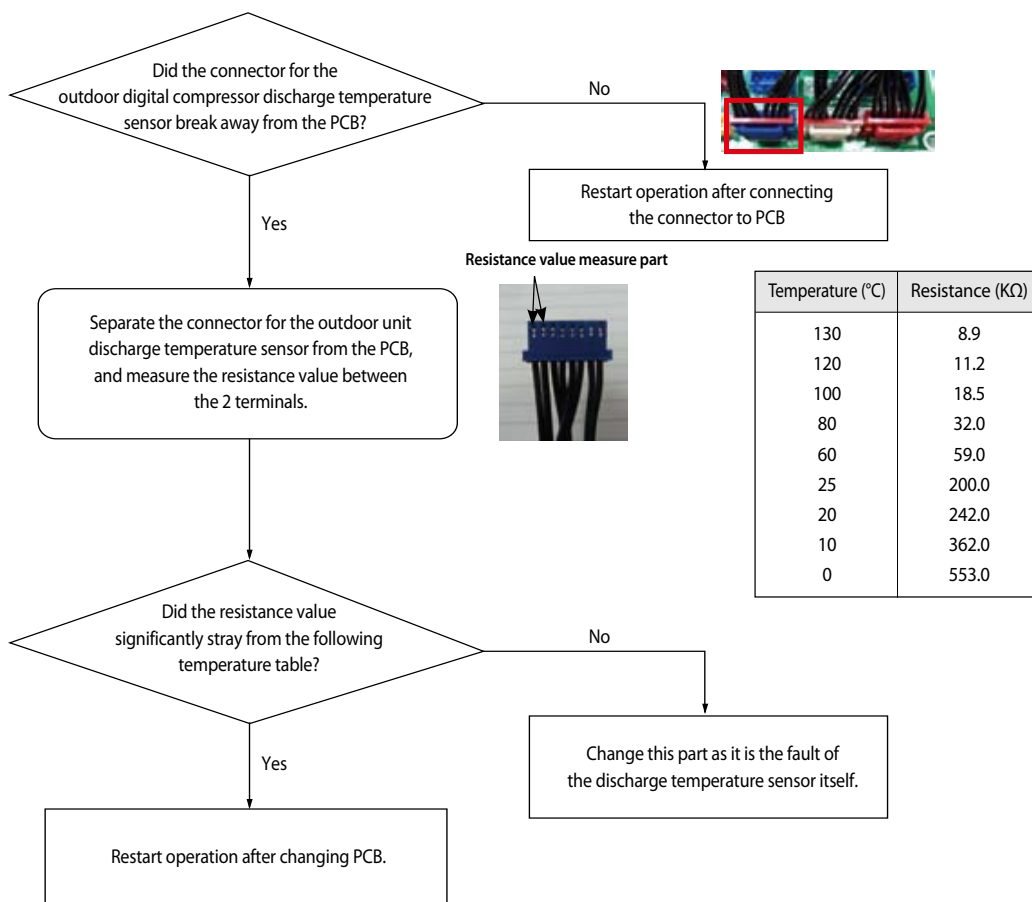

4-4-44 Constant Rate Compressor Discharge Temperature Sensor Error (OPEN/SHORT)

Outdoor unit display	<i>E257, E258</i> (Compressor 2, Compressor 3)																
Indoor unit display	Duct, Cassette (1 way / 2 way / Mini-4 way)				4 Way Cassette Type				Wall mounted Type				Circular Cassette Type				
	Display LED																
	1 way Blue Yellow-Green		or or	Operation		Defroster	Timer	Filter	18 °C	21 °C	Reser- vation	24 °C	27 °C	Sky- Blue	Yellow- Green	Blue	Red
	2 way Green Red			or	or	or	or	or	or	or	or	or	or	or	or	or	or
●	×	×	●	×	●	×	●	×	●	×	●	×	×	×	●	×	

Criteria • Refer to the inspection method below.

Cause of problem • Constant rate compressor discharge temperature sensor OPEN/SHORT problem

1. Inspection Method

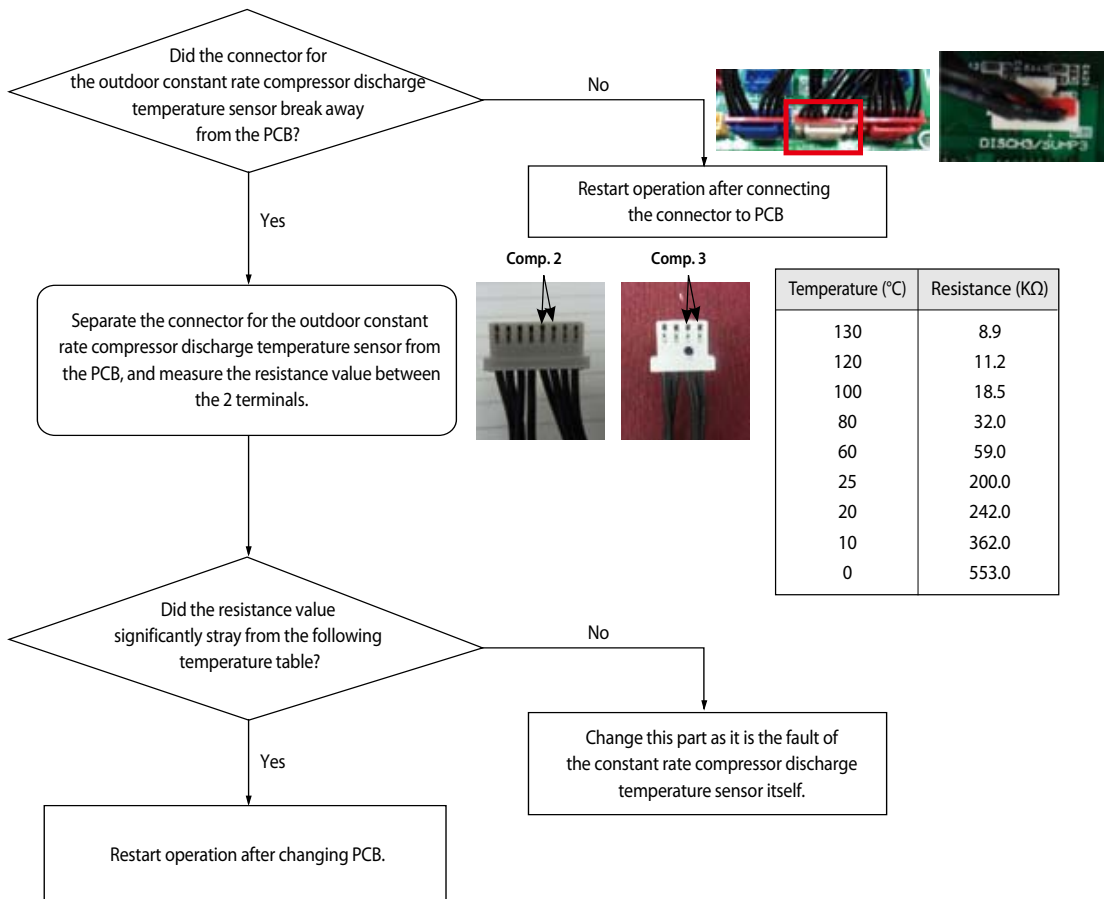

4-4-45 Compressor Discharge or Top 1/2 Temperature sensor error

Outdoor unit display	E262 (Compressor 1 Discharge) E263 (Compressor 2 Discharge)													
	E266 (Compressor 1 Top) E267 (Compressor 2 Top)													
Indoor unit display	Duct, Cassette (1 way / 2 way / Mini-4 way)	4 Way Cassette Type	Wall mounted Type	Circular Cassette Type										
	Display LED													
	1 way Blue Yellow-Green	2 way Green Red	Operation or Defroster	Timer	Filter	18 °C	21 °C	Reser- -vation	24 °C	27 °C	Sky- -Blue	Yellow- -Green	Blue	Red
	X	X	X	●	●	●	X	●	●	●	X	●	●	X
Criteria	· Refer to the judgment method below.													
Cause of problem	· Compressor Discharge or Top Temperature sensor defective. (Open/Short)													

1. Cause of problem

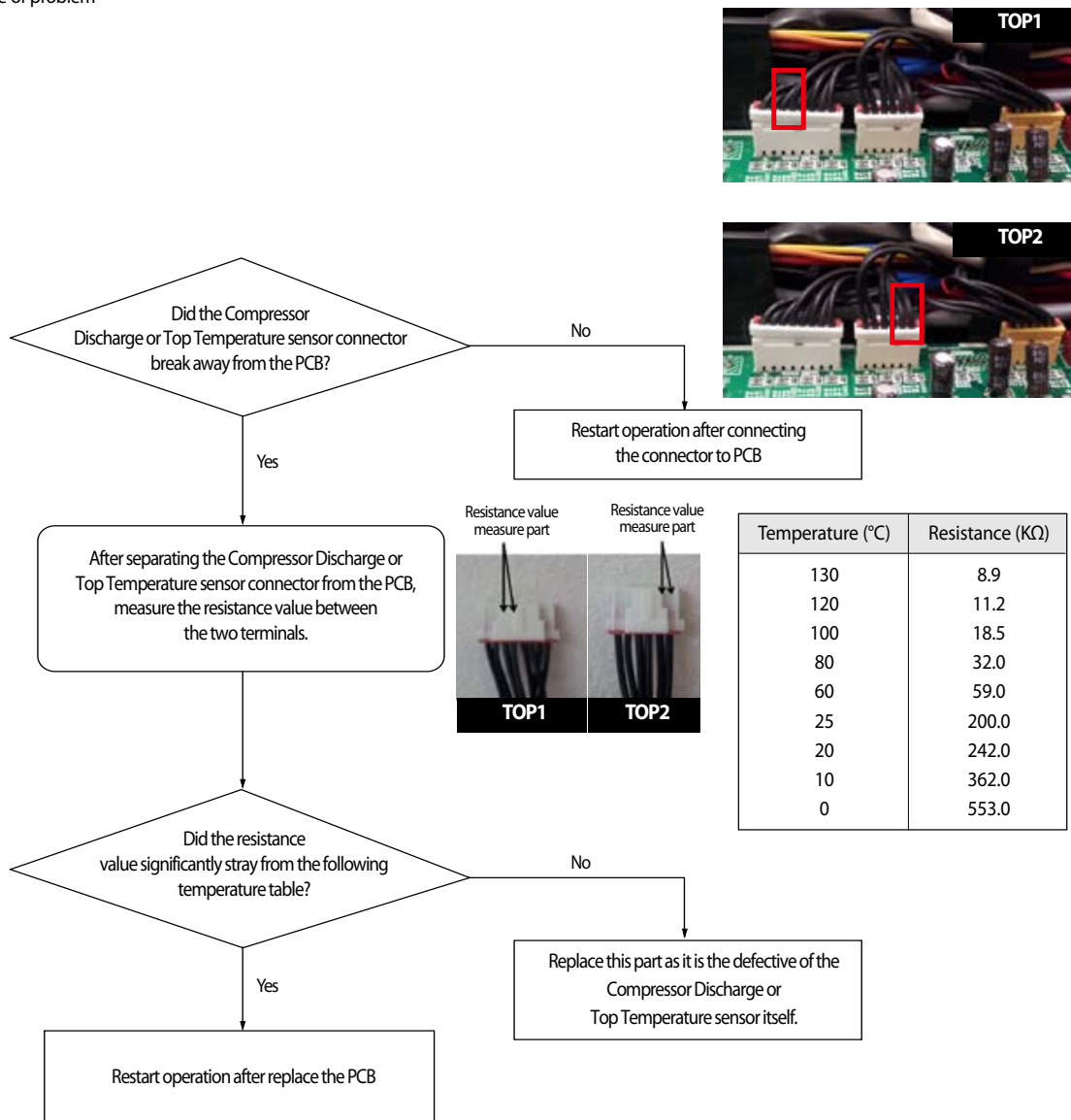

4-4-46 **E265** : Dislocation error of Compressor SUMP Temperature (oil temperature) Sensor

Outdoor unit display	E265 (digital compressor or fixed compressor 1)
Indoor unit display	x(Operation) ●(Timer) ●(Fan) ●(Filter) x(Defrost)
Criteria	• Refer to how to determine below
Cause of problem	• Sump (oil) temperature sensor dislocation error

1. How to diagnose

- 1) If the Sump temperature right before the start of compressor = $T_{\text{sump.ini}}$, current compressor's SUMP temp = $T_{\text{sump.real}}$,
 When the difference between $T_{\text{sump.ini}}$ and $T_{\text{sump.real}}$ is an absolute value so that it cannot be more than 2°C,
 In other words, the condition of $T_{\text{sump.real}} - T_{\text{sump.ini}} < 2^{\circ}\text{C}$ has been satisfied for 60 minutes since a compressor started, it is diagnosed as an error.
 After 60 minutes of compressor operation, there will be no Sump sensor dislocation detection.

2. How to check

- 1) Check if a sensor of the relevant compressor has been dislocated in accordance with error code, assemble and correct the error.

4-4-47 E269 : Suction Temperature sensor breakaway error

Outdoor unit display	E269																				
Indoor unit display	Duct, Cassette (1 way / 2 way / Mini-4 way)				4 Way Cassette Type				Wall mounted Type				Circular Cassette Type								
	Display LED																				
	1 way	Blue	Yellow-Green	2 way	Green	Red	or	or	Operation	Defroster	Timer	Filter	18 °C	21 °C	Reser- vation	24 °C	27 °C	Sky- Blue	Yellow- Green	Blue	Red
	1 way								Operation	Defroster	Timer	Filter	18 °C	21 °C	Reser- vation	24 °C	27 °C	Sky- Blue	Yellow- Green	Blue	Red
x	x	●	●	●	x	●	●	●	x	x	●	●	●	x	x	●	x				
Criteria · If the suction temperature right before operating the Comp, when the operating order is highest, is set at $T_{suc, ini}$, and the suction temperature of the current Comp is set at $T_{suc, real}$, it is considered to have an error if the condition of $T_{suc, real} < T_{suc, ini} < 2^{\circ}C$ is maintained for 30 minutes.																					
Cause of problem · Suction temperature sensor breakaway/defective.																					

1. Cause of problem

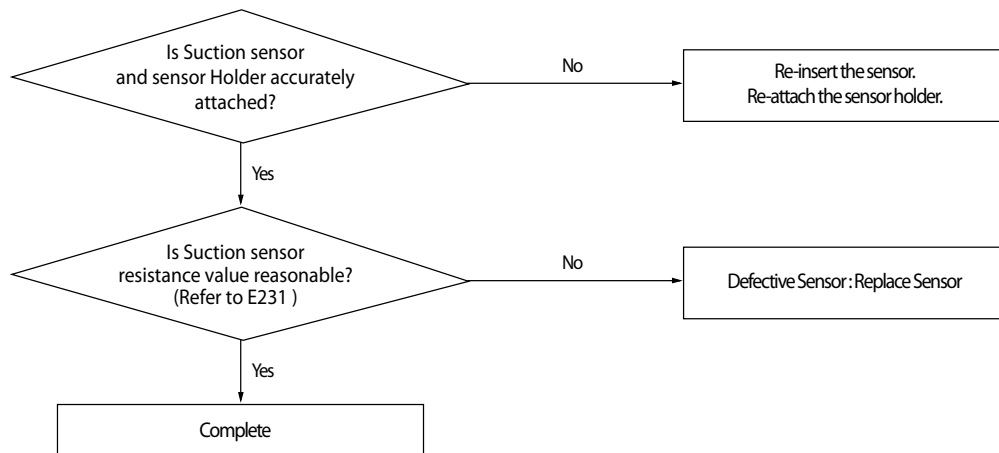

4-4-48 SUMP Temperature Sensor Error (OPEN/SHORT)

Outdoor unit display	E271
Indoor unit display	●(Operation) ×(Reservation) ●(Blast) ×(Filter) ×(Defrost)
Criteria	• Refer to the judgment method below.
Cause of problem	• Disconnection or breakdown of relevant sensor

1. Inspection Method

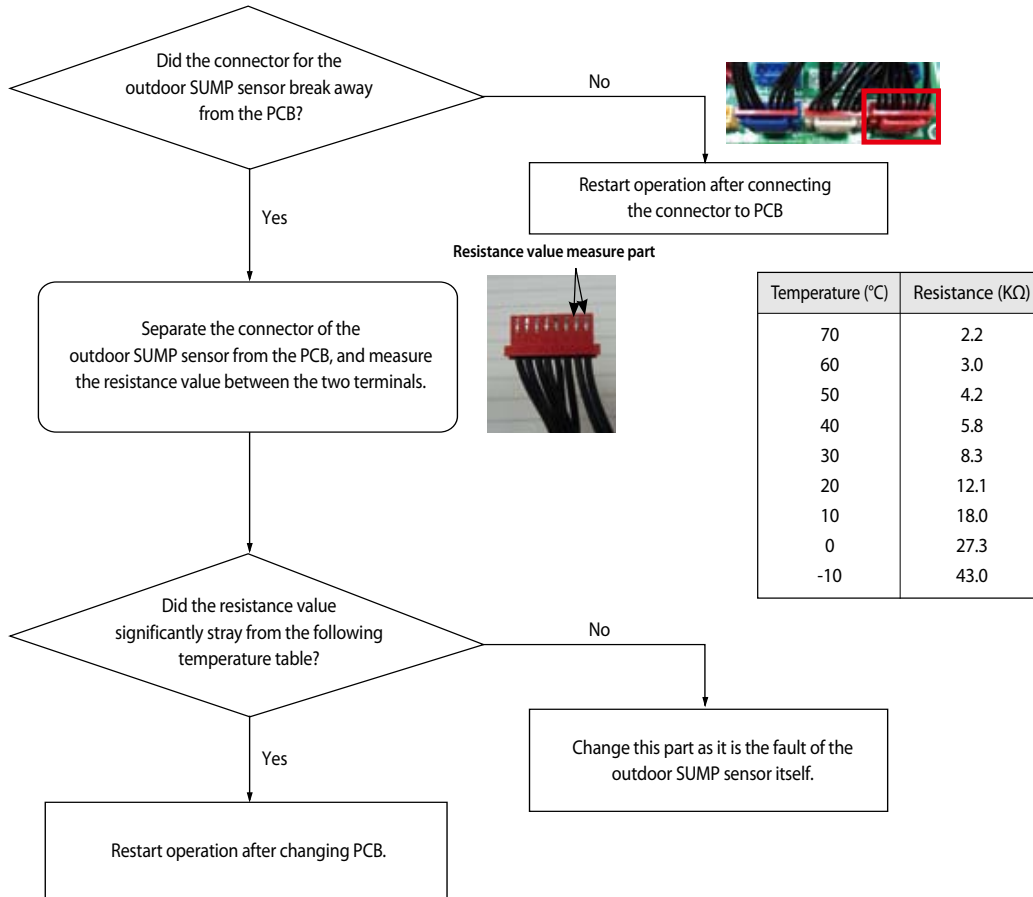

4-4-49 High Pressure sensor error (Open/Short)

Outdoor unit display	E291															
Indoor unit display	Duct, Cassette (1 way / 2 way / Mini-4 way)				4 Way Cassette Type				Wall mounted Type				Circular Cassette Type			
	Display LED															
	1 way Blue Yellow-Green		or or	Operation Defroster		Timer Filter		18 °C	21 °C	Reser- -vation	24 °C	27 °C	Sky- -Blue	Yellow- -Green	Blue	Red
	2 way Green Red			or	or	or	or	or	or	or	or	or	or	or	or	or
●	×	×	●	×	●	×	●	×	●	×	×	●	×	×	●	×
Criteria	· Refer to the judgment method below.															
Cause of problem	· Disconnection or breakdown of relevant sensor.															

- High Pressure sensor Open/Short error determination method
 - Identifies from when power is supplied or 2 minutes after RESET, and only when set is stopped.
 - An Open/Short error will occur if the input voltage standard range of 0.5V ~ 4.95V is exceeded.

2. Inspection Method

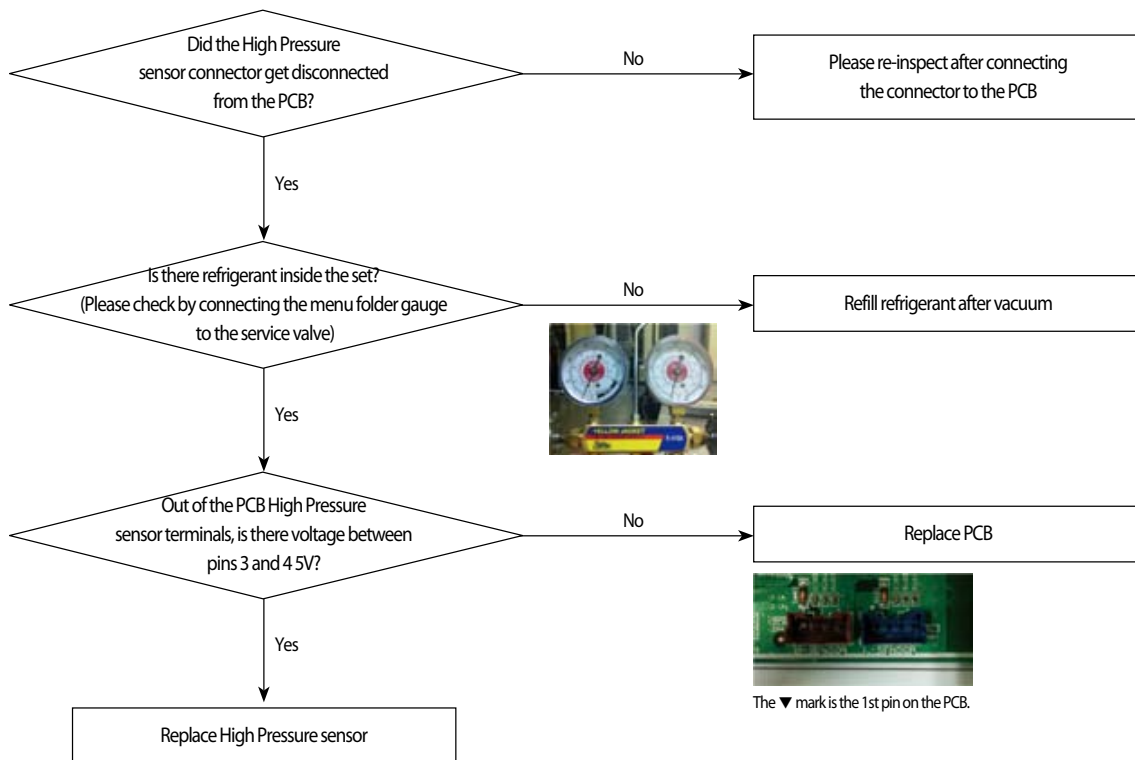

4-4-50 Low Pressure sensor error (Open/Short)

Outdoor unit display	E296																				
Indoor unit display	Duct, Cassette (1 way / 2 way / Mini-4 way)				4 Way Cassette Type				Wall mounted Type				Circular Cassette Type								
	Display LED																				
	1 way	Blue	Yellow-Green	2 way	Green	Red	or	or	Operation	Defroster	Timer	Filter	18 °C	21 °C	Reser- -vation	24 °C	27 °C	Sky- -Blue	Yellow- -Green	Blue	Red
	1 way																				
1 way	×	×	×	○	×	○	×	○	×	○	×	○	×	○	×	○	×	○	×	○	×
2 way	×	×	×	○	×	○	×	○	×	○	×	○	×	○	×	○	×	○	×	○	×
Criteria	· Refer to the judgment method below.																				
Cause of problem	· Disconnection or breakdown of relevant sensor.																				

1. Low Pressure sensor Open/Short error determination method
 - 1) Identifies from when power is supplied or 2 minutes after RESET, and only when set is stopped.
 - 2) An Open/Short error will occur if the input voltage standard range of 0.5V ~ 4.95V is exceeded.

2. Inspection Method

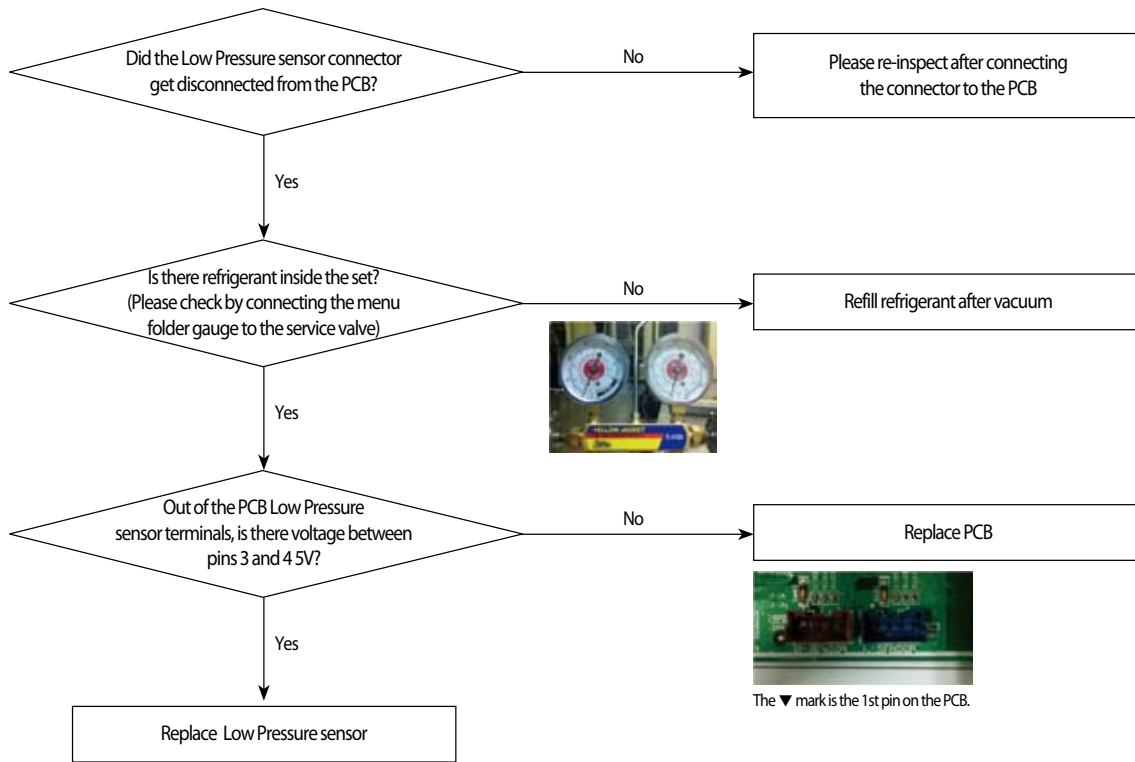

4-4-51 Suction Temperature sensor error (Open/Short)

Outdoor unit display	E308																	
Indoor unit display	Duct, Cassette (1 way / 2 way / Mini-4 way)				4 Way Cassette Type				Wall mounted Type				Circular Cassette Type					
	Display LED																	
	1 way	Blue	Yellow-Green	or	or	Operation	Defroster	Timer	Filter	18 °C	21 °C	Reser- vation	24 °C	27 °C	Sky- Blue	Yellow- Green	Blue	Red
	2 way	Green	Red	or	or	or	or	or	or	or	or	or	or	or	or	or	or	or
	●	×	×	●	×	●	×	●	×	●	×	×	●	×	×	●	×	
Criteria	· Refer to the judgment method below.																	
Cause of problem	· Disconnection or breakdown of relevant sensor.																	

1. Cause of problem

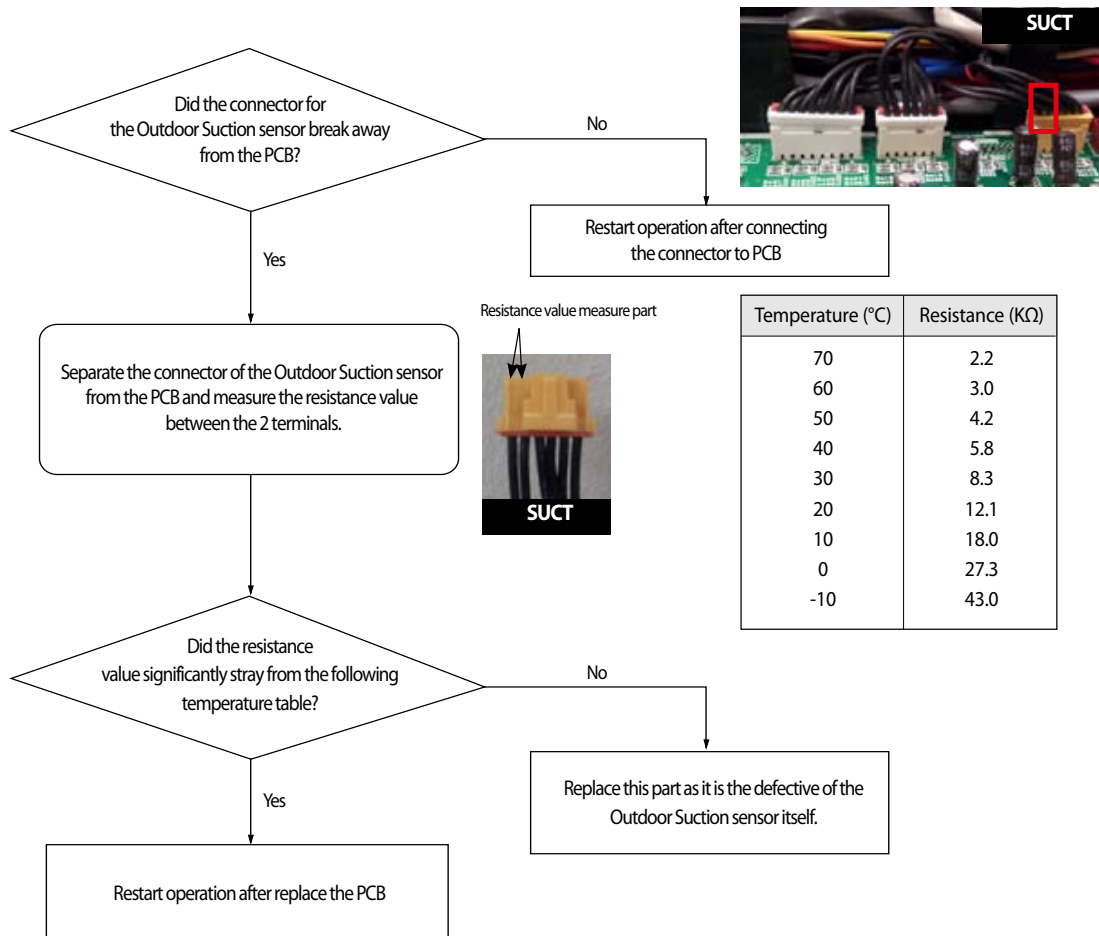

4-4-52 Liquid Pipe Temperature sensor error (Open/Short)

Outdoor unit display	E311																
Indoor unit display	Duct, Cassette (1 way / 2 way / Mini-4 way)				4 Way Cassette Type				Wall mounted Type				Circular Cassette Type				
	Display LED																
	1 way		or	or	Operation	Defroster	Timer	Filter	18 °C	21 °C	Reser- vation	24 °C	27 °C	Sky- Blue	Yellow- Green	Blue	Red
	Blue	Yellow- Green			or	or	or	or	or	or	or	or	or	or	or	or	or
2 way		or	or	or	or	or	or	or	or	or	or	or	or	or	or	or	
Green	Red			or	or	or	or	or	or	or	or	or	or	or	or	or	or
Criteria	· Refer to the judgment method below.																
Cause of problem	· Disconnection or breakdown of relevant sensor.																

1. Cause of problem

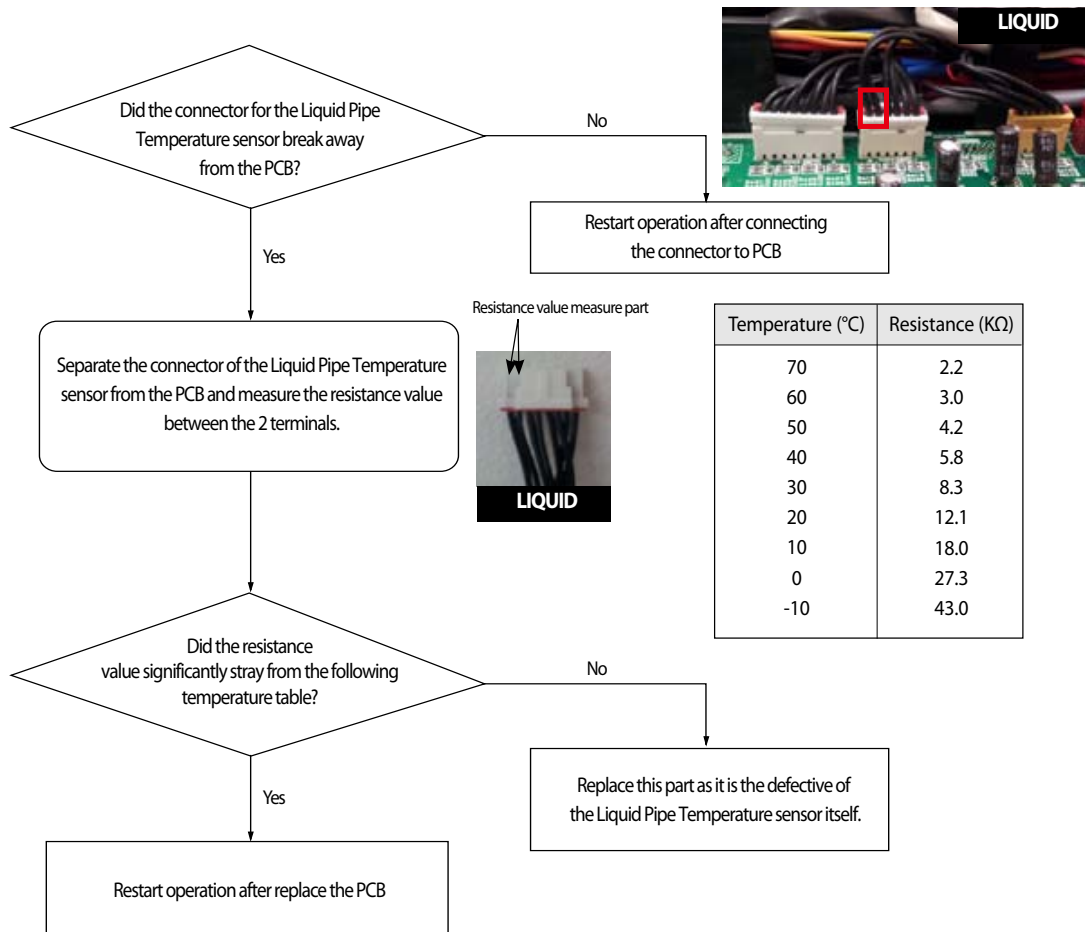

4-4-53 EVI In Temperature sensor error (Open/Short)

Outdoor unit display	E321																	
Indoor unit display	Duct, Cassette (1 way / 2 way / Mini-4 way)				4 Way Cassette Type				Wall mounted Type				Circular Cassette Type					
	Display LED																	
	1 way	Blue	Yellow-Green	or	or	Operation	Defroster	Timer	Filter	18 °C	21 °C	Reser- vation	24 °C	27 °C	Sky- Blue	Yellow- Green	Blue	Red
	2 way					Green	Red	or	or	or	or	or	or	or	or	or	or	or
●	×	×	○	×	●	×	○	×	●	×	×	○	×	×	×	○	×	
Criteria	· Refer to the judgment method below.																	
Cause of problem	· Disconnection or breakdown of relevant sensor.																	

1. Cause of problem

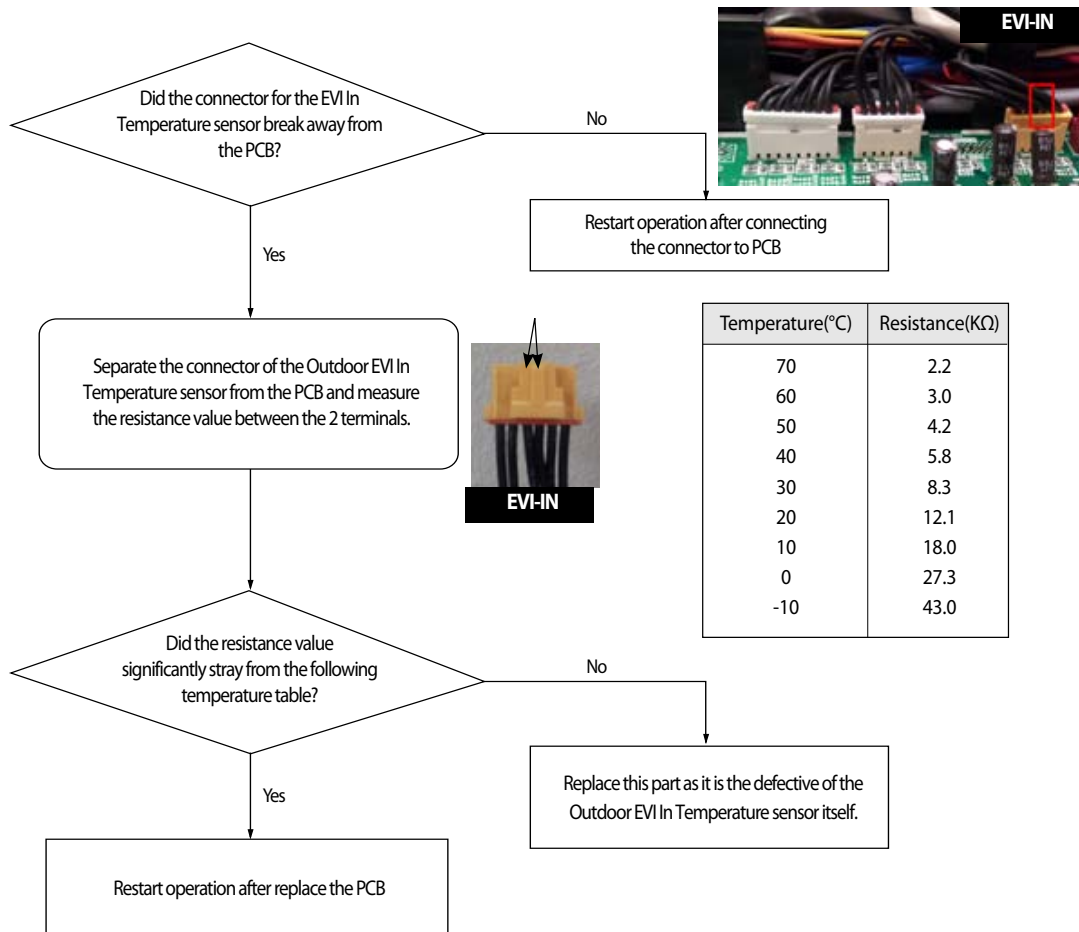

4-4-54 EVI Out Temperature sensor error (Open/Short)

Outdoor unit display	E322															
Indoor unit display	Duct, Cassette (1 way / 2 way / Mini-4 way)				4 Way Cassette Type				Wall mounted Type				Circular Cassette Type			
	Display LED															
	1 way Blue Yellow-Green		or or	Operation Defroster		Timer Filter		18 °C	21 °C	Reser- vation	24 °C	27 °C	Sky- Blue	Yellow- Green	Blue	Red
	2 way Green Red			or or		or or		or or		or or		or or		or or		or or
●	×	×	●	×	●	×	●	×	●	×	●	×	●	×	●	×
Criteria	· Refer to the judgment method below.															
Cause of problem	· Disconnection or breakdown of relevant sensor.															

1. Cause of problem

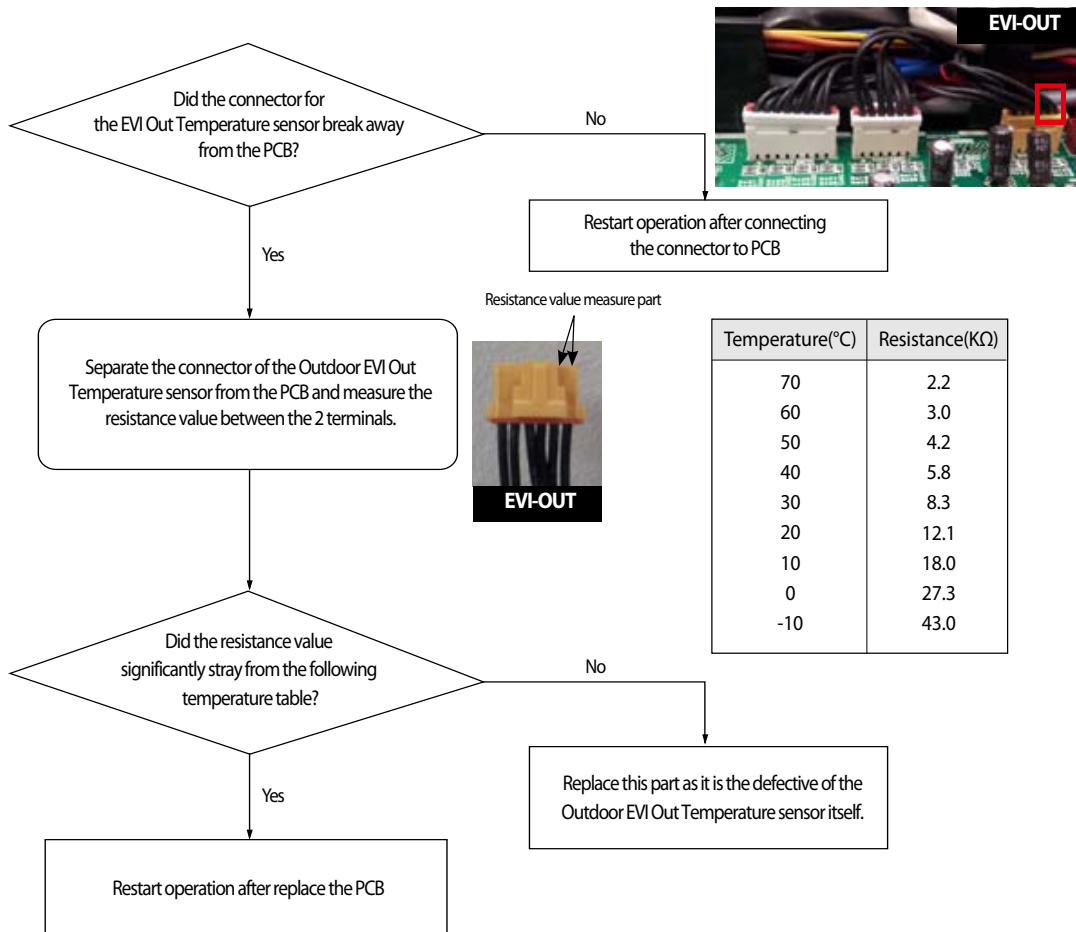

4-4-55 Suction-2 Temperature Sensor Error (OPEN/SHORT)

Outdoor unit display	E323																
Indoor unit display	Duct, Cassette (1 way / 2 way / Mini-4 way)				4 Way Cassette Type				Wall mounted Type				Circular Cassette Type				
	Display LED																
	1 way Blue Yellow-Green		or or	or or	Operation	Defroster	Timer	Filter	18 °C	21 °C	Reser- -vation	24 °C	27 °C	Sky- -Blue	Yellow- -Green	Blue	Red
	2 way Green Red				⏻	⏻	⏻	⏻	⏻	⏻	⏻	⏻	⏻	⏻	⏻	⏻	⏻
●	×	×	●	×	●	×	●	×	●	×	×	●	×	×	●	×	
Criteria	• Refer to the judgment method below.																
Cause of problem	• Disconnection or breakdown of relevant sensor																

1. Inspection Method

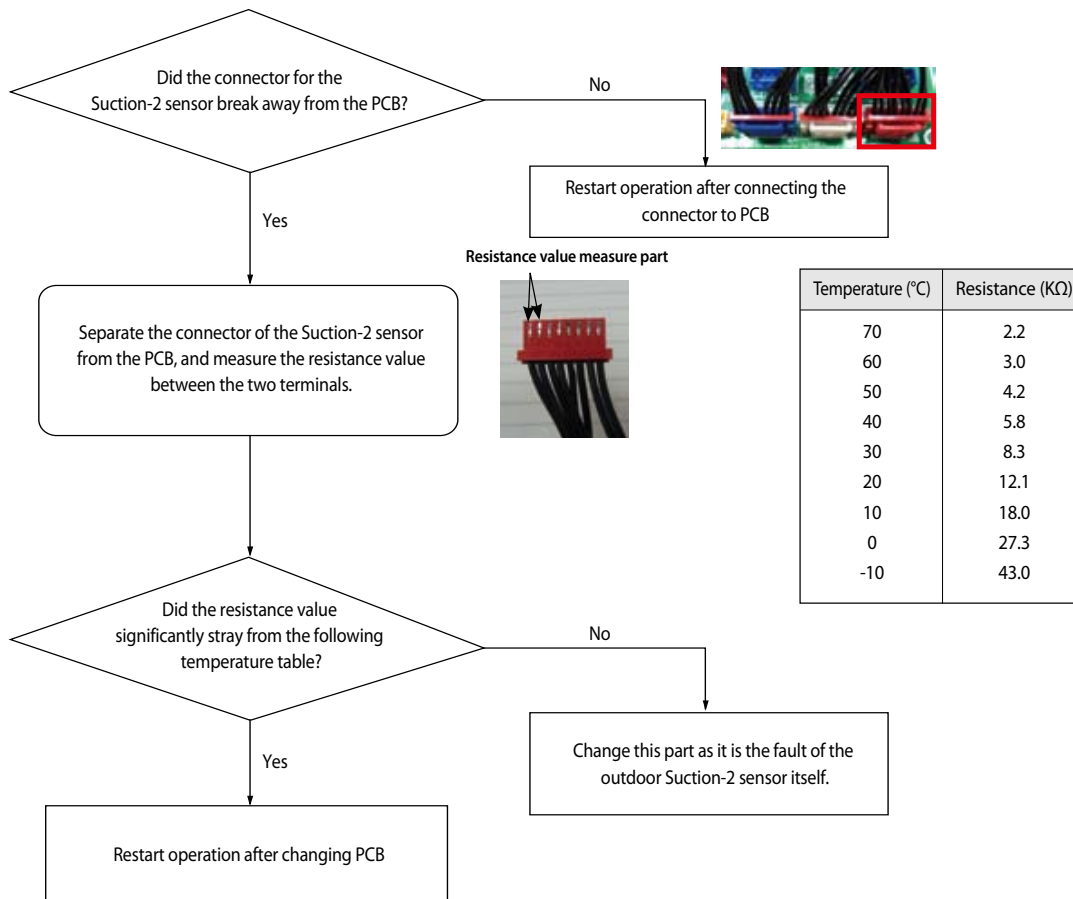

4-4-56 E407 : Comp. Down due to High Pressure Protection Control

Outdoor unit display	E407																	
Indoor unit display	Duct, Cassette (1 way / 2 way / Mini-4 way)				4 Way Cassette Type				Wall mounted Type				Circular Cassette Type					
	Display LED																	
	1 way	Blue	Yellow-Green	or	or	Operation	Defroster	Timer	Filter	18 °C	21 °C	Reser- vation	24 °C	27 °C	Sky- Blue	Yellow- Green	Blue	Red
	2 way					Green	Red	or	or	or	or	or	or	or	or	or	or	or
X	X	●	●	●	X	●	●	●	X	X	●	●	●	X	X	●	X	

Criteria · Value of the high pressure sensor is detected at 40kg/cm² or more .

- Cause of problem
- <Cooling Operation>**
 - Outdoor unit fan motor problem (constrained, defective)
 - Motor driver defective or wire is cut
 - Outdoor heat exchanger is contaminated.
 - Service valve locked/Fill refrigerant
 - <Heating Operation>**
 - Outdoor unit fan motor problem (constrained, defective)
 - Motor driver defective or wire is cut
 - Service valve locked/Excessive refrigerant

1. Cause of problem

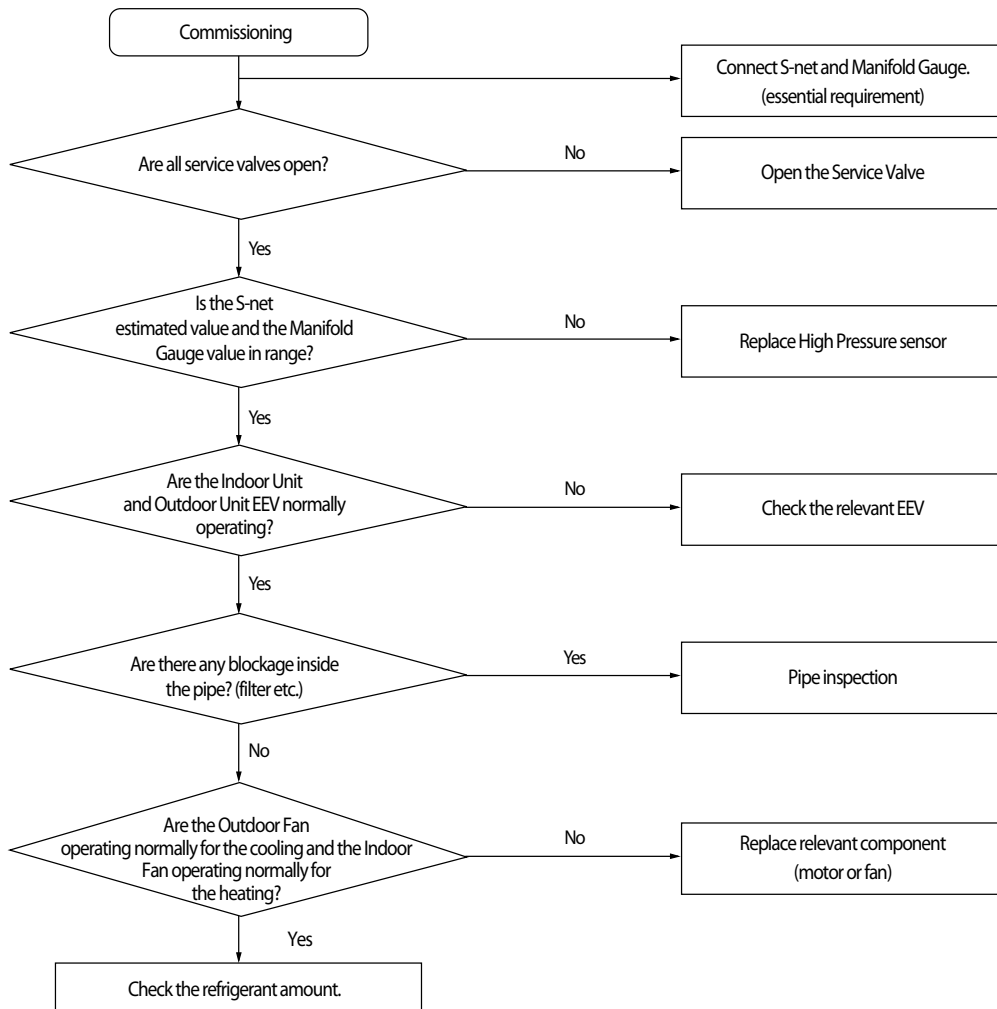

4-4-57 E4 10 : Comp. Down due to Low Pressure Protection Control

Outdoor unit display	E4 10																
Indoor unit display	Duct, Cassette (1 way / 2 way / Mini-4 way)				4 Way Cassette Type				Wall mounted Type				Circular Cassette Type				
	Display LED																
	1 way		or	or	Operation	Defroster	Timer	Filter	18 °C	21 °C	Reser- vation	24 °C	27 °C	Sky- Blue	Yellow- Green	Blue	Red
	Blue	Yellow- Green			or	or	or	or	or	or	or	or	or	or	or	or	or
2 way		or	or	Operation	Defroster	Timer	Filter	18 °C	21 °C	Reser- vation	24 °C	27 °C	Sky- Blue	Yellow- Green	Blue	Red	
Green	Red			or	or	or	or	or	or	or	or	or	or	or	or	or	or
X		X		●	●	●	●	X	X	●	●	●	X	X	●	X	

Criteria · Inspection when the value of low pressure sensor is 0.8kg/cm², or less for air conditioning and 0.6kg/cm² for heating.

Cause of problem

- Refrigerant shortage
- Electronic expansion valve blocked
- Service valve blocked
- Low pressure sensor defective
- Leakage of compressor discharge check valve of not-go-end outdoor unit
- Error may be found when used in temperature range outside the conditions of use (Operating outside temperature at -20°C or less for heating and operating outside temperature at -5°C or less for Cooling)

1. Cause of problem

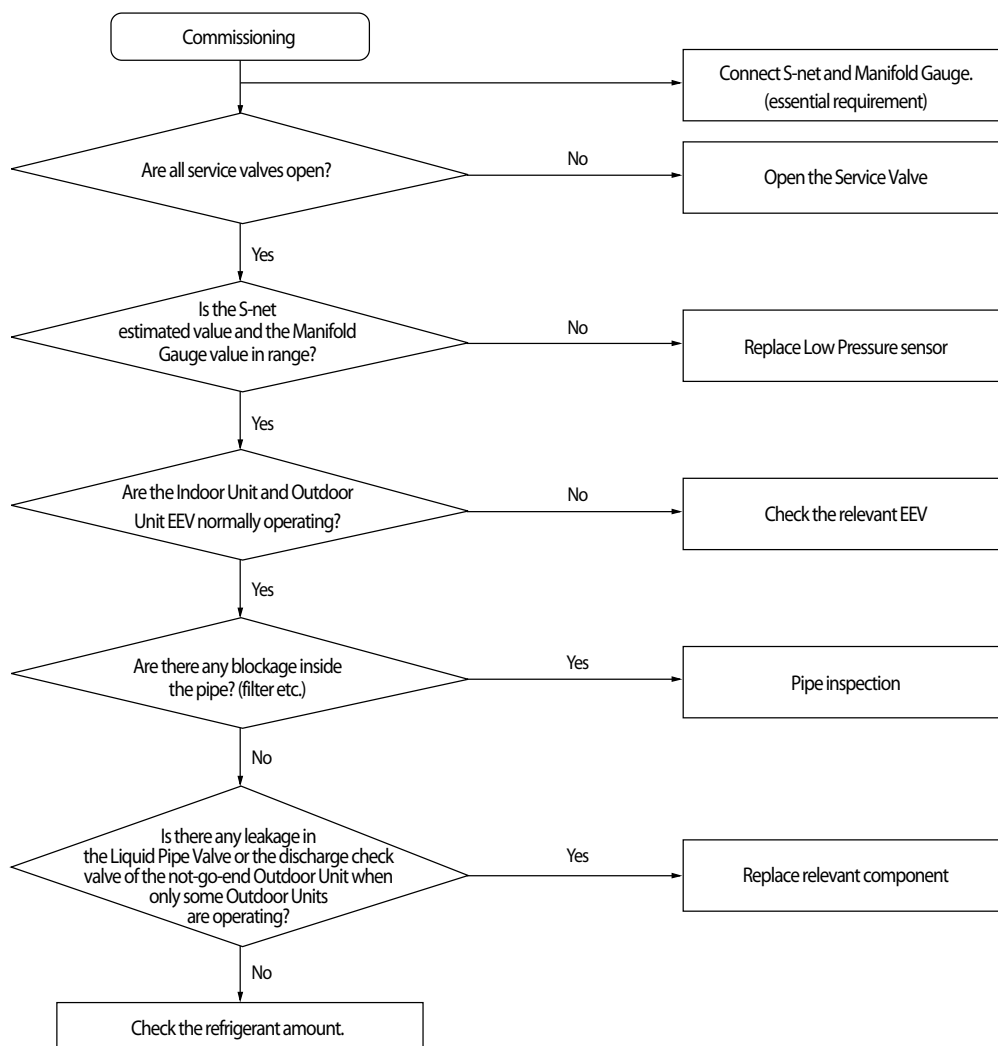

4-4-58 Sump Sensor Error Due to Protection Control

Outdoor unit display	E413
Indoor unit display	×(Operation) ●(Reservation) ●(Blast) ●(Filter) ×(Defrost)
Criteria	• Maintain sump temperature of 95°C or more for five minutes
Cause of problem	• Compressor loading faulty/sump temperature sensor faulty

1. Inspection Method

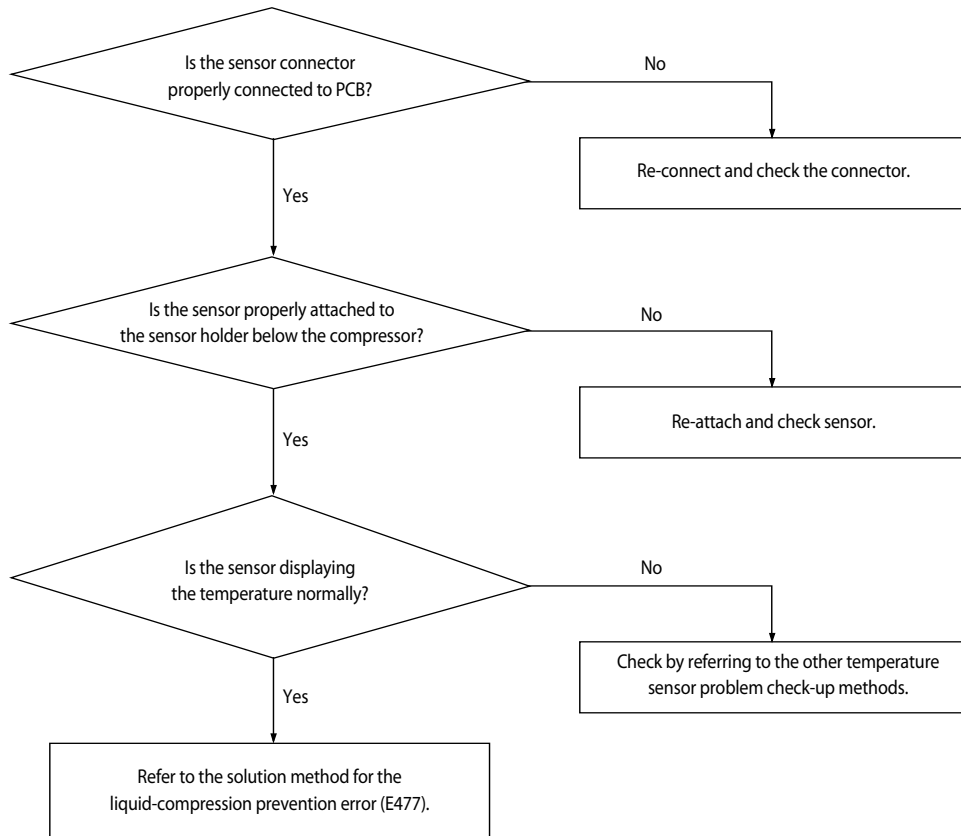

4-4-59 E4 16 : Comp. Down due to Compressor Discharge Temperature sensor

Outdoor unit display	E4 16																		
Indoor unit display	Duct, Cassette (1 way / 2 way / Mini-4 way)				4 Way Cassette Type				Wall mounted Type				Circular Cassette Type						
	Display LED																		
	1 way		Blue	Yellow-Green	or	or	Operation	Defroster	Timer	Filter	18 °C	21 °C	Reser- vation	24 °C	27 °C	Sky- Blue	Yellow- Green	Blue	Red
	2 way						Green	Red	or	or	or	or	or	or	or	or	or	or	or
×	×	○	○	○	×	○	○	○	○	×	×	○	○	○	×	×	○	×	

Criteria · When value of compressor discharge temperature sensor is checked at 120°C or more

- Cause of problem
- Refrigerant shortage
 - Electronic expansion valve is blocked.
 - Service valve blocked
 - Defective discharge temperature sensor
 - Blocked pipe and defective
 - Leakage of compressor discharge check valve of not-go-end outdoor unit

1. Cause of problem

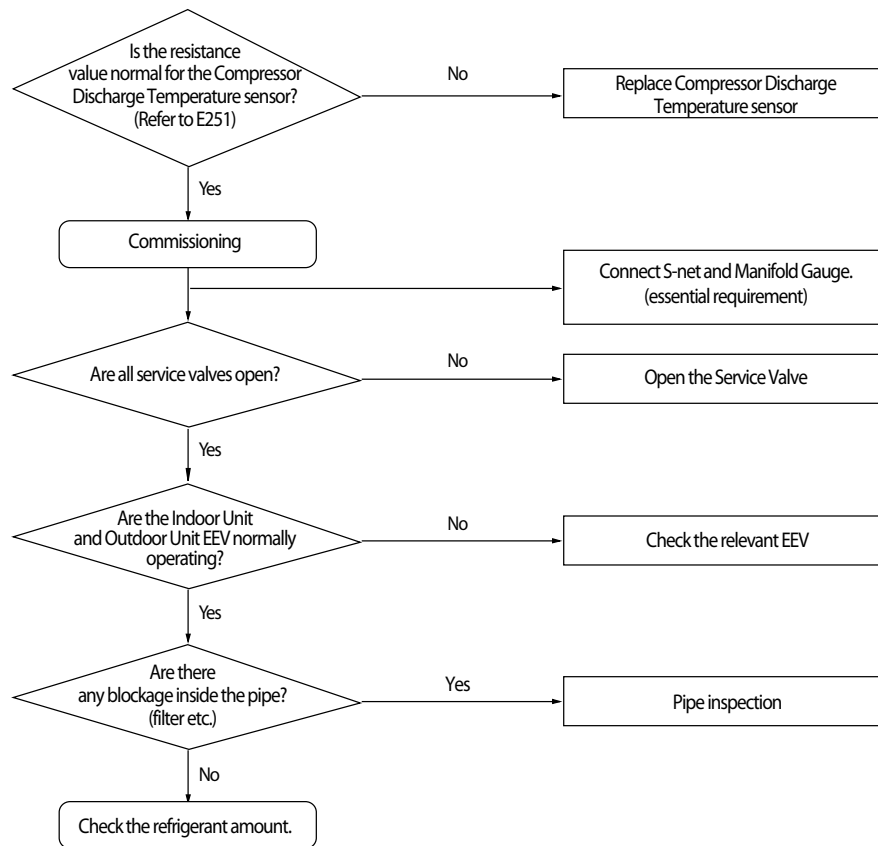

4-4-60 3-phase Input Wiring error

Outdoor unit display	E425																		
Indoor unit display	Duct, Cassette (1 way / 2 way / Mini-4 way)				4 Way Cassette Type				Wall mounted Type				Circular Cassette Type						
	Display LED																		
	1 way		Blue	Yellow-Green	or	or	Operation	Defroster	Timer	Filter	18 °C	21 °C	Reser- vation	24 °C	27 °C	Sky- Blue	Yellow- Green	Blue	Red
	2 way						Green	Red	⏻	⏻	⏻	⏻	⏻	⏻	⏻	⏻	⏻	⏻	⏻
		×	×	○	○	○	×	○	○	○	○	○	○	○	×	×	○	×	
		×	×	○	○	○	×	○	○	○	○	○	○	○	×	×	○	×	
Criteria	<p>· When turn on the power and check the status of the power from the inverter. If the phase does not connect the power(no phase) : E425 or E466 (E366) is displayed (Air conditioner to maintain the normal state.) However) N-phase must be properly connected.</p>																		
Cause of problem	<p>· Check the input wiring · EMI Fuse short</p>																		

1. Cause of problem

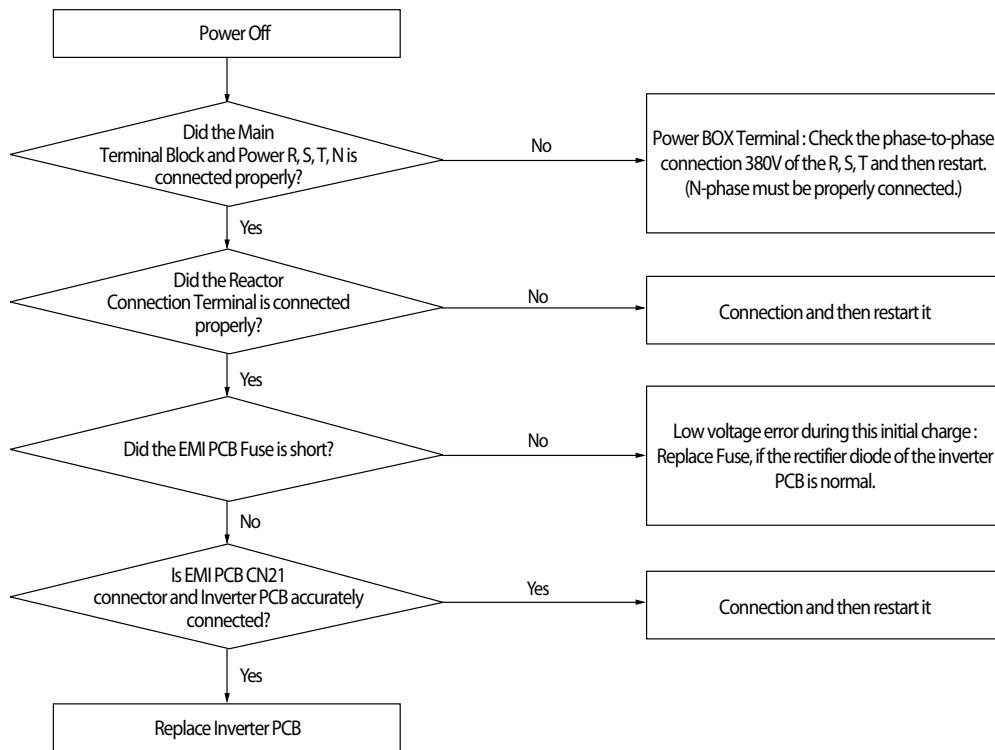

4-4-61 E428 : Comp. Down by Compression Ratio Control

Outdoor unit display	E428																
Indoor unit display	Duct, Cassette (1 way / 2 way / Mini-4 way)				4 Way Cassette Type				Wall mounted Type				Circular Cassette Type				
	Display LED																
	1 way Blue Yellow-Green		or	or	Operation	Defroster	Timer	Filter	18 °C	21 °C	Reser- vation	24 °C	27 °C	Sky- Blue	Yellow- Green	Blue	Red
	2 way Green Red				or	or	or	or	or	or	or	or	or	or	or	or	or
x	x	●	●	●	x	●	●	●	x	x	●	●	●	x	x	●	x

- Criteria**
- When compression ratio (high pressure+1)/(low pressure+1) less than 1.5 and lasts for 10 minutes or more
 - Differential pressure (high pressure - low pressure) less than 0.4 MPa.g and lasts for 10 minutes or more

- Cause of problem**
- Indoor and Outdoor EEV breakdown
 - 4Way Valve breakdown
 - High and Low pressure sensor defective
 - Refrigerant shortage

1. Cause of problem

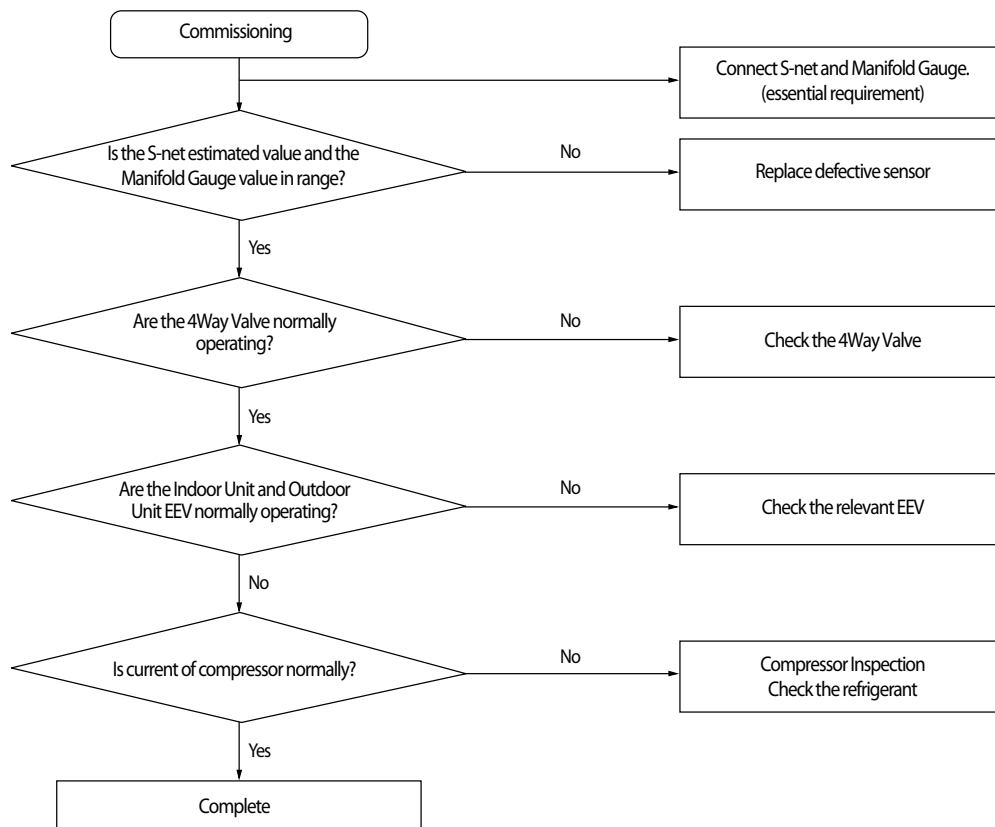

4-4-62 EVI EEV Open error

Outdoor unit display	E438
Indoor unit display	-
Criteria	. DSH <10 °C, EVI Out-in <= 0°C & frequency> 65Hz 40 minutes maintaining
Cause of problem	. EVI EEV and Intercooler leakage, excessive refrigerant amount, Outdoor Check Valve inserted opposite. . Indoor Unit EEV leakage, direct connection between Indoor Liquid Pipe and the Gas Pipe.

※ Indoor EEV leakage can be easily checked during the operation of cooling operation and during the not-go-end blast operation.
(In case it is normal, the EVA In and Out temperatures for the blast may rise.)

※ If cooling operation is operated for low temperature with excessive refrigerant amount, then the DSH may descend.

1. Cause of problem

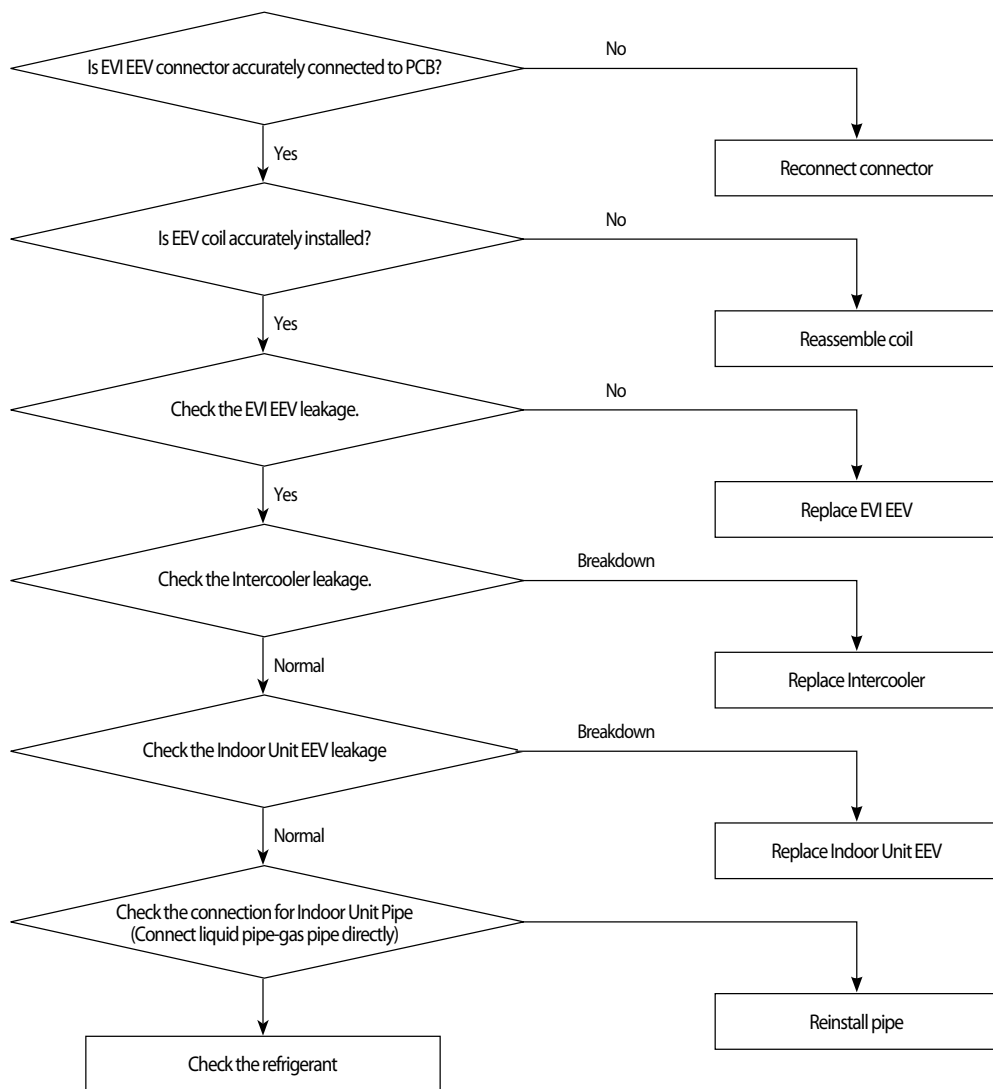

4-4-63 Refrigerant Leakage Error

Outdoor unit display	E439
Indoor unit display	-
Criteria	• Refer to the judgment method below
Cause of problem	• Leakage of refrigerant, simultaneous malfunction of pressure sensor

■ Low-pressure sensor OPEN/SHORT error determination method

1. Identifies from when power is supplied or 2 minutes after RESET, and only when set is stopped.
2. An E439 error will occur if the input voltage standard ranges of 0.5V ~ 4.95V of both the high- and low-pressure sensors are exceeded.
3. Will occur if the measured value of both high- and low-pressure sensors is 1kgf/cm²G

1. Inspection method

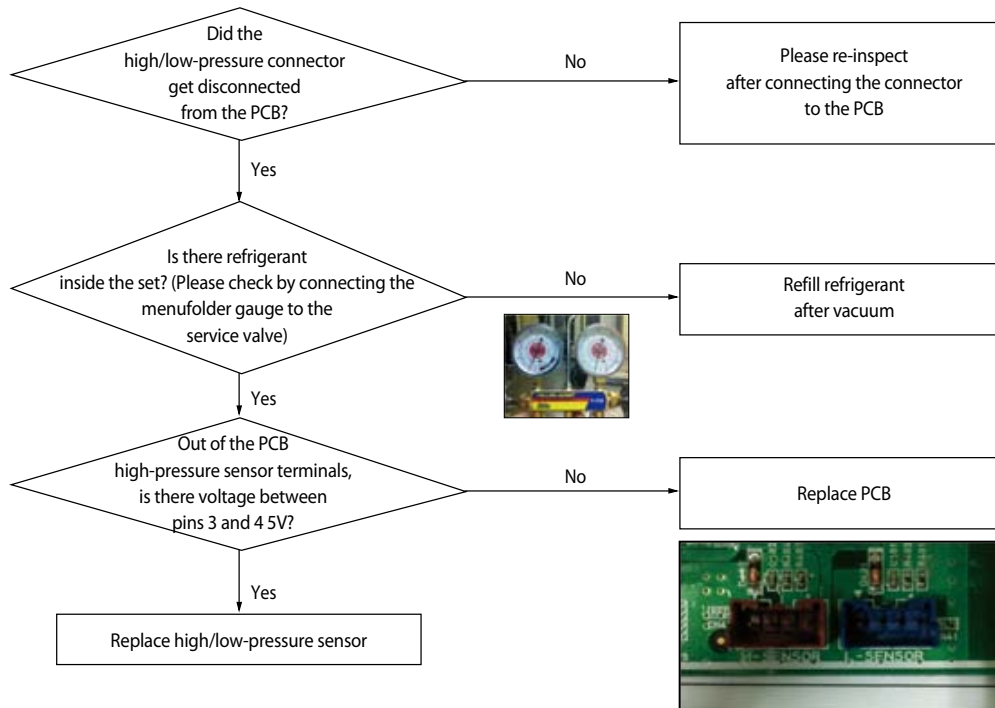

The ▼ mark is the 1st pin on the PCB.

4-4-64 E440, E442 : Prohibition of the operation of Compressor due to Outdoor Temperature

Outdoor unit display	E440 (prohibit heating operation in outdoor temperature over 30°C) E442 (prohibit heat filling operation in outdoor temperature over 15°C)
Indoor unit display	No sign
Criteria	E440 : Right before an outdoor unit starts heating operation by On signal of an indoor Remocon, the error occurs and prohibits the operation in outdoor temperature over 30°C E442 : Right before operating heat refrigerant filling mode by the K1 switch of an outdoor PCB, the error occurs and prohibits the operation in outdoor temperature over 15°C
Cause of problem	• Operation Prohibition mode by the indoor temperature limit

1. How to check

The above error code is not caused by a product's problem but a function to protect the product by limiting the available temperature range so please refer to the usable temperature range in the product manual.

If the error code is displayed despite a condition that does not belong to any of the above diagnosis methods, read the temperature sensor value of the outdoor inlet air with View Mode or S-net, and if the actual outdoor temperature is different, please replace the temperature sensor.

4-4-65 High Pressure Standard Not Met before Air Conditioning (Inability to Re-operate)

Outdoor unit display	E443
Indoorunit display	×(Operation) ● (Reservation) ● (Blast) ● (Filter) ×(Defrost)
Judgment Method	. Operation should be forbidden if High Pressure sensor value of the Main Unit before the pump down is started at 2.2kg/cm ² g or below for air-conditioning and 1.0kg/cm ² G or less for heating for three consecutive seconds. (Restarting operation is not possible, and an error displayed on the indoor unit.)
Cause of problem	. Refrigerant leakage/fault in High Pressure sensor .

1. Cause of problem

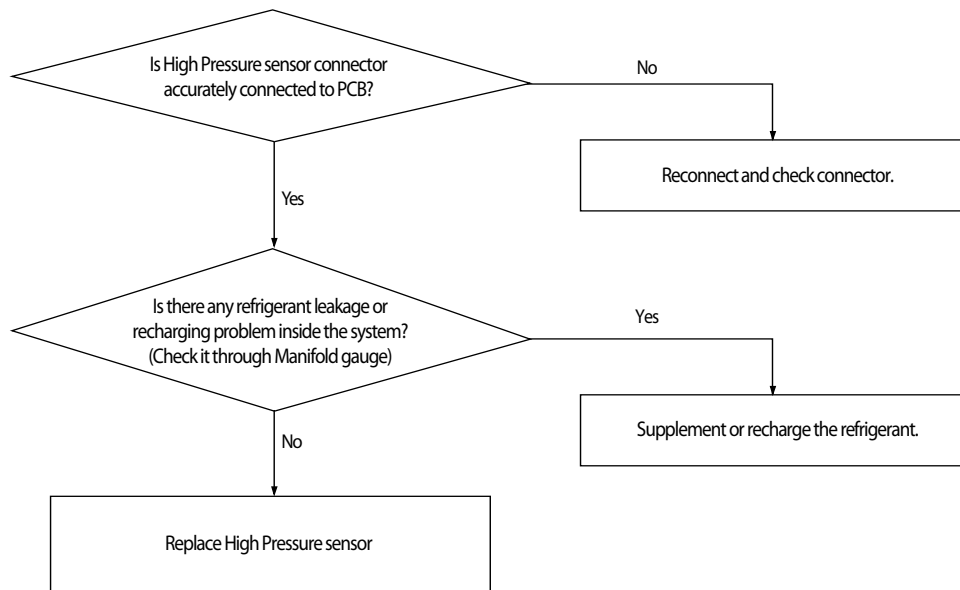

4-4-66 CCH Malfunction and Sump Sensor Miswiring Error

Outdoor Unit Display	E445
Indoor Unit Display	-
Judgment Method	• Refer to the judgment method below
Special Cause	• CCH Connector PCB is not connected / Sump sensor compressor separated / Own problem of CCH

1. Judgment Method

Tini = Sump temperature when entering the CH operation delay condition

Tlast= Sump temperature when maintaining CH operation delay for two hours

Outside Air Temperature Sensor Value: Outside air temperature when maintaining CH operation delay for two hours

① Tlast – Tini < 2°C

② Tlast < Outside Air Temperature Sensor Value + 2°C

③ Outside Air Temperature Sensor Value < 30°C

If ① , ② and ③ are satisfied at the same time, then display E445.

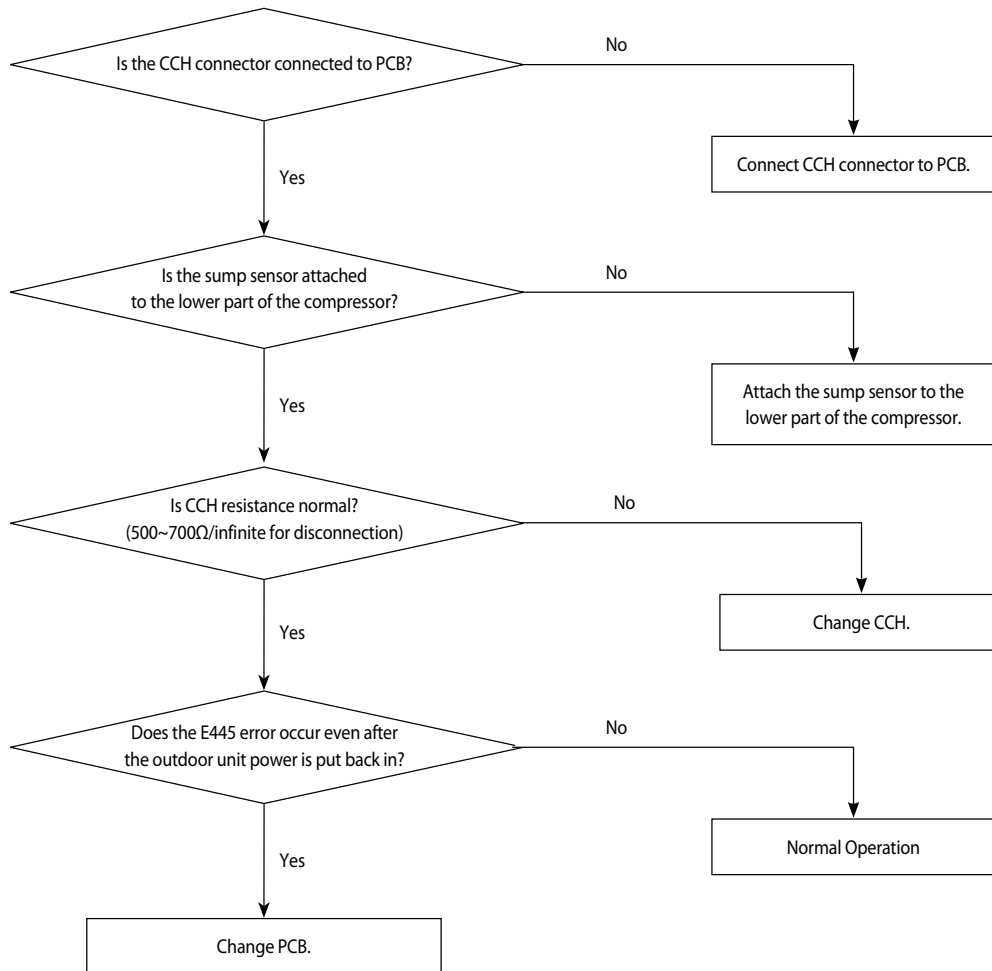

4-4-67 Fan starting error

Outdoor unit display	E446 (FAN PCB(FAN1)) E346 (FAN PCB(FAN2))
Judgment Method	<ul style="list-style-type: none"> · Startup, and then if the speed increase is not normally. · Detected by H/W or S/W
Cause of problem	<ul style="list-style-type: none"> · Compressor connection error · Defective Compressor · Defective PCB

1. Cause of problem

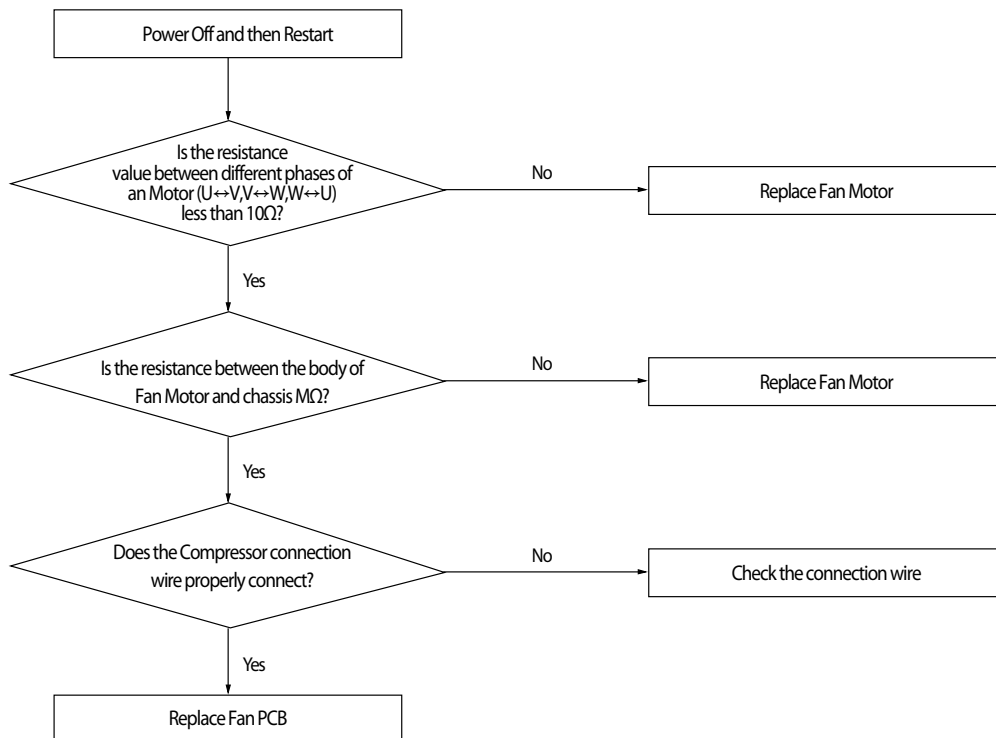

4-4-68 Fan lock error

Outdoor unit display	E448 (FAN PCB(FAN1)) E348 (FAN PCB(FAN2))
Indoor unit display	-
Criteria	· Is checked symptoms by phase current of Fan Motor.
Cause of problem	· Fan Motor connection error. · Defective Fan · Defective PCB

1. Cause of problem

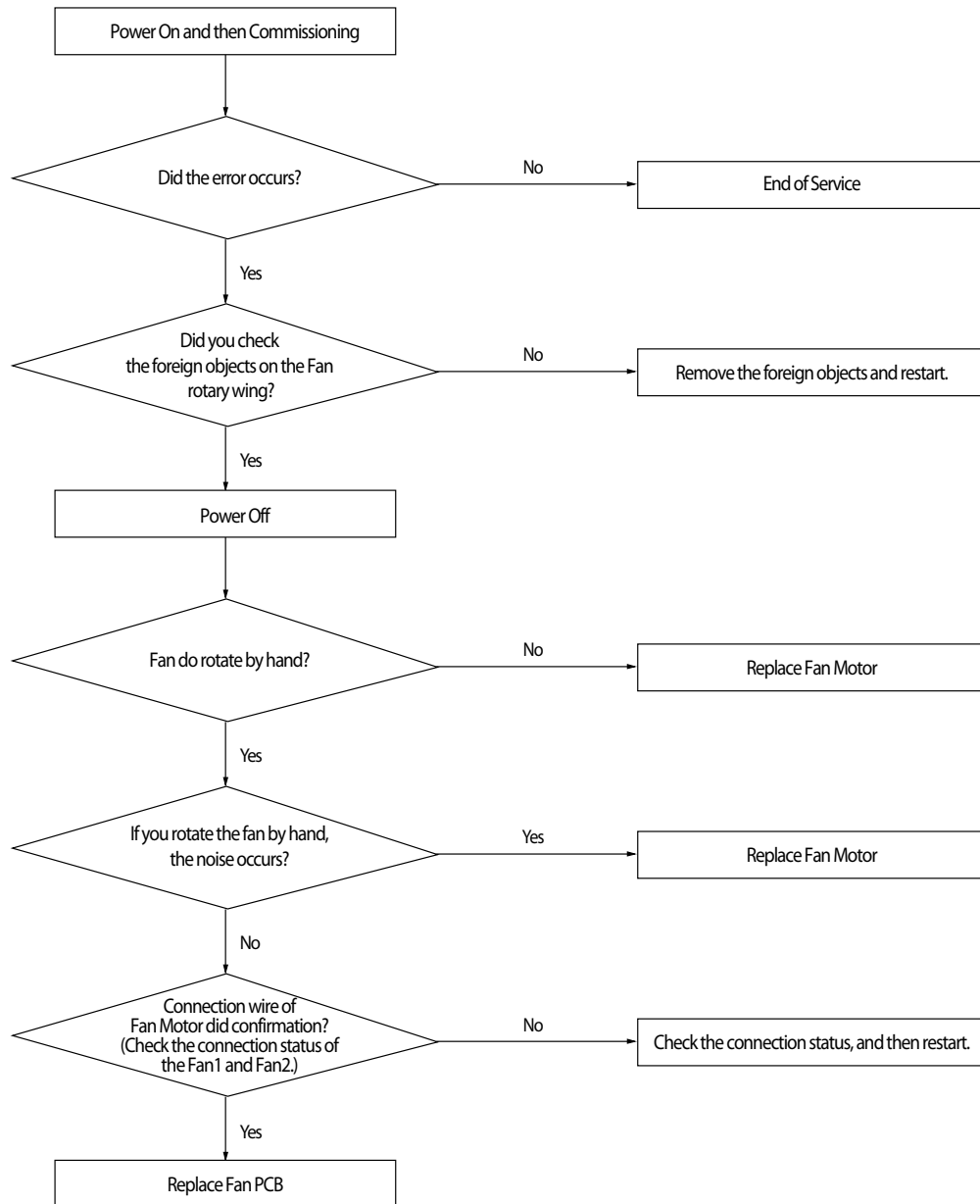

4-4-69 Momentary Blackout error

Outdoor unit display	E452																	
Indoor unit display	Duct, Cassette (1 way / 2 way / Mini-4 way)				4 Way Cassette Type				Wall mounted Type				Circular Cassette Type					
	Display LED																	
	1 way		or	or	Operation	Defroster	Timer	Filter	18 °C	21 °C	Reser- vation	24 °C	27 °C	Sky- Blue	Yellow- Green	Blue	Red	
	Blue	Yellow- Green			Power	Defroster	Timer	Filter										
2 way		or	or	Operation	Defroster	Timer	Filter	18 °C	21 °C	Reser- vation	24 °C	27 °C	Sky- Blue	Yellow- Green	Blue	Red		
Green	Red			Power	Defroster	Timer	Filter											
	X	X	●	●	●	X	●	●	●	X	X	●	●	●	X	X	●	X
Criteria	· Momentary stop of compressor due to momentary blackout.																	
Cause of problem	· Momentary stop of compressor due to momentary blackout.																	

1. Precautions : Replace Hub PCB or Main Hub Connection wire.

4-4-70 Outdoor Fan Motor overheating

Outdoor unit display	<i>E453</i> (FAN PCB(FAN1)) <i>E353</i> (FAN PCB(FAN2))
Indoor unit display	· Overheating due to the internal sensor of the Fan Motor.
Criteria	· Defective connection wire · Defective Fan Motor · Defective PCB · Defective installation conditions
Cause of problem	· Fan Motor connection error. · Defective Fan · Defective PCB

1. Cause of problem

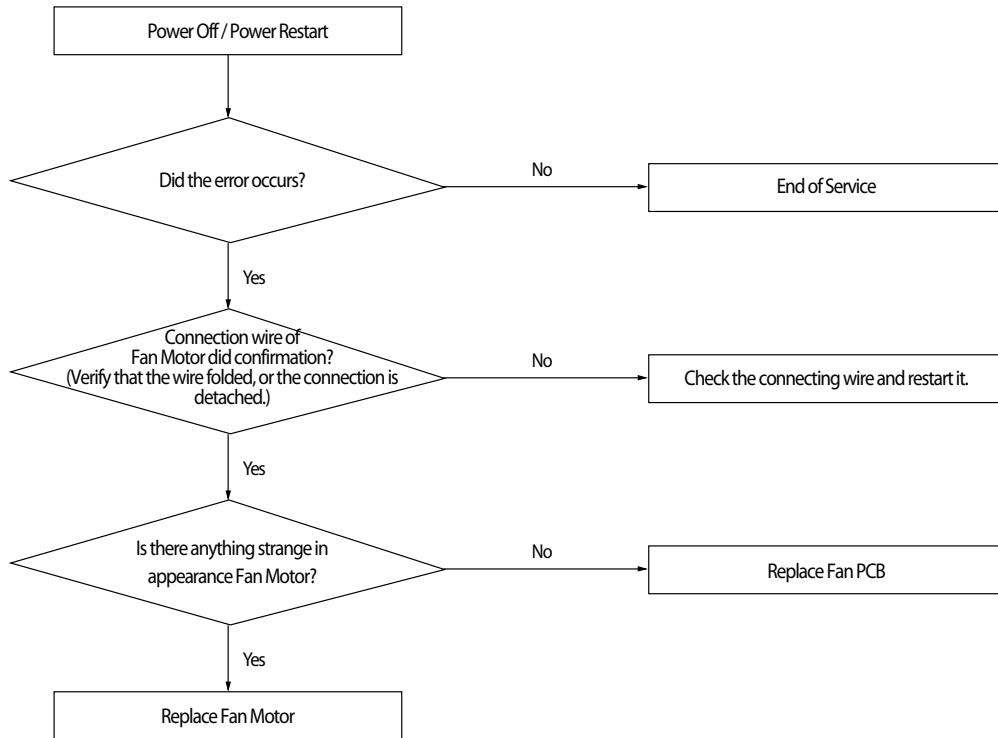

4-4-71 Outdoor Unit Fan Motor RPM Error

Outdoor unit display	E454
Indoor unit display	-
Criteria	• In case the number of the revolutions of the outdoor unit fan motor in motion is different by 100 rpm or more compared to the instructed value.
Cause of problem	• Outdoor unit fan motor constrained or faulty of operation

1. Inspection Method

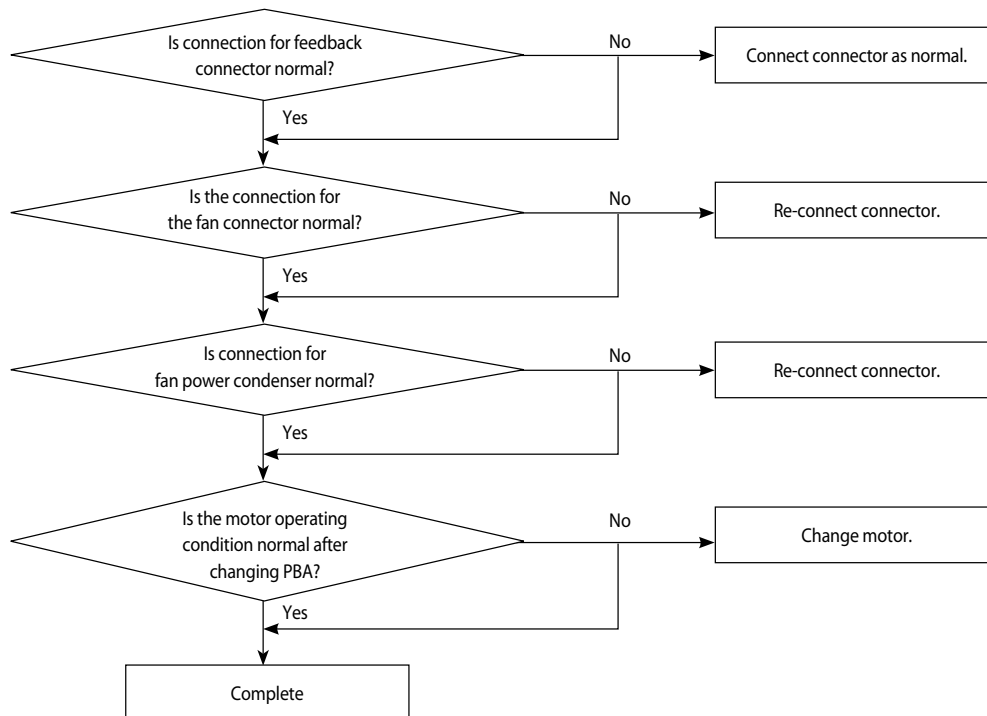

4-4-72 Fan IPM Overheat error

Outdoor unit display	<i>E455</i> (FAN1 PCB) <i>E355</i> (FAN2 PCB)
Criteria	· IPM internal temperature more than 85°C (E455, E355)
Cause of problem	· Heat sink and IPM assembly defective. · Defective heat sink cooling

1. Cause of problem

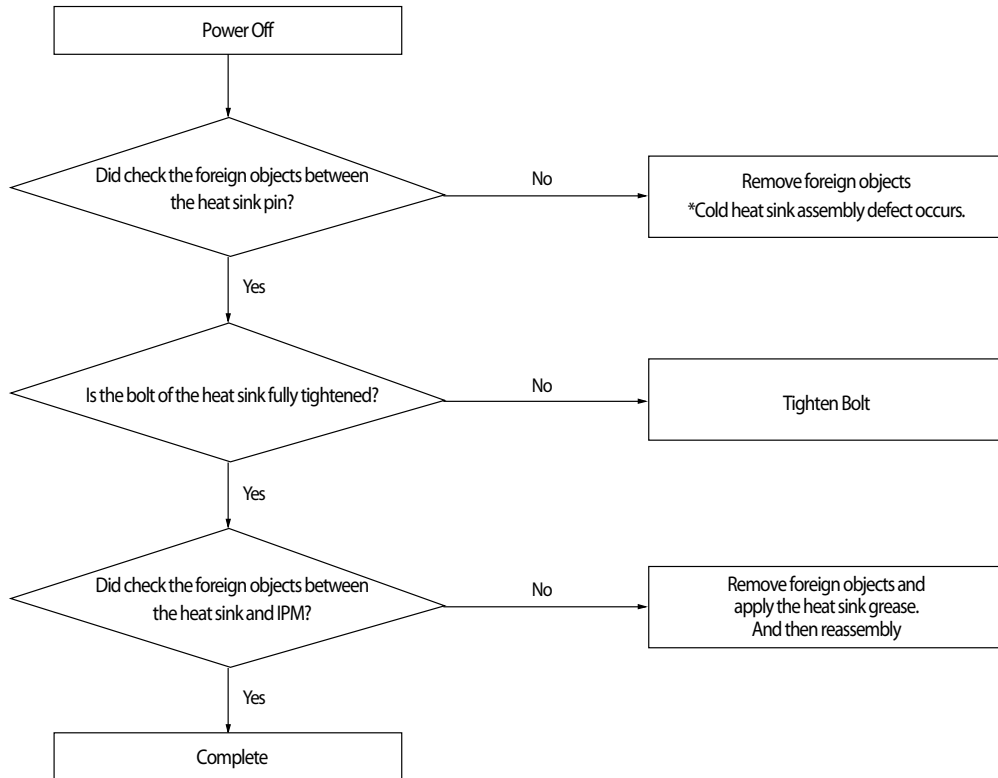

4-4-73 Over-Voltage Error of an Outdoor Fan Motor

Outdoor unit display	E456
Indoor unit display	-
Criteria	• When the current of an operating outdoor fan motor is more than 7A for 1 minute
Cause of problem	• Outdoor fan motor lock or defect • Occurs by abrupt start or overload

1. How to check
 - 1) Check if outdoor fan motor rotates or is locked
 - 2) If it is not locked, the above error occurs due to overload and signals by abnormal operation, and it indicates the overload status. Thus, it is not breakdown.
 - 3) Need to check if there is a problem with fan load status

4-4-74 Counter-Rotation Error of an Outdoor Fan Motor

Outdoor unit display	E457
Indoor unit display	-
Criteria	• When the rotational direction of an outdoor fan motor is counter-clockwise before operating
Cause of problem	• Due to wind that can run the fan counter-wise

1. How to diagnose
 - 1) Check if the start instruction of outdoor unit's fan is counter-clockwise
2. How to check
 - 1) It is a signal to protect a motor by checking the operational condition of the outdoor unit's fan motor without power so as not to operate it in counter-clockwise condition.
 - 2) Check if there is wind strong enough to force a fan to rotate counter-clockwise where the outdoor unit is installed.

4-4-75 E45B : Compressor Excess Current Error

Outdoor Unit Display	E45B
Indoor Unit Display	×(Operation) ●(Reservation) ●(Blast) ●(Filter) ×(Defrost)
Judgment Method	• Error displayed if the CT sensor value of the relevant compressor is 20A or more and is maintained for more than 3 seconds.
Special Cause	• Breakdown of compressor/Faulty CT sensor

1. Cause of problem

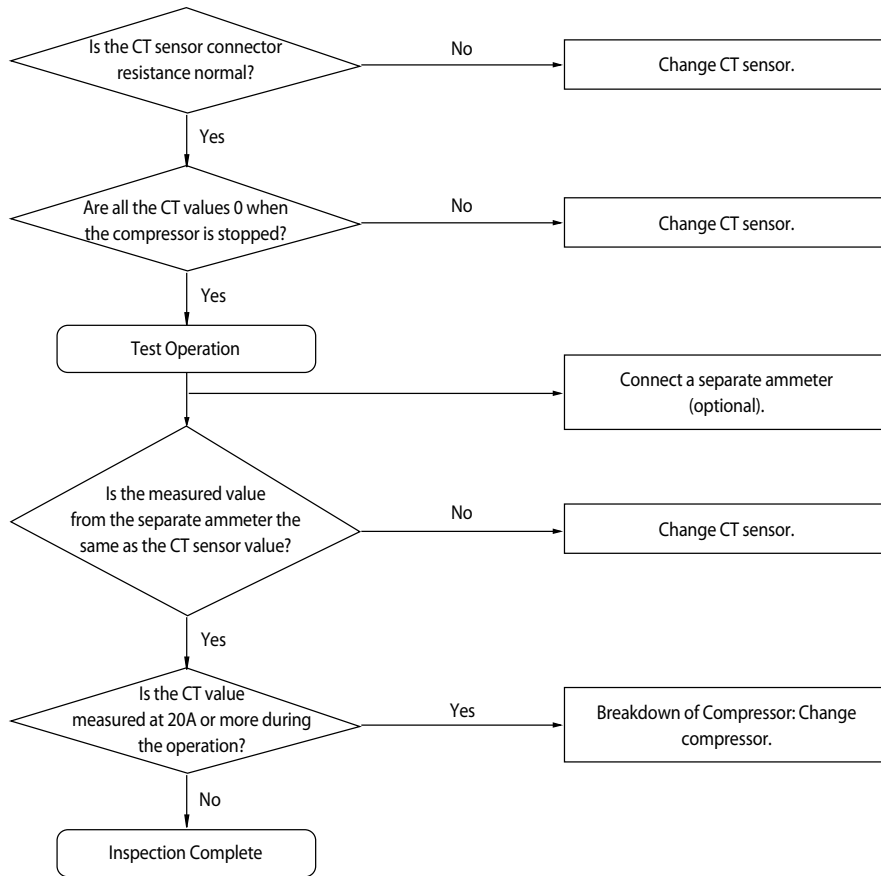

4-4-76 Compressor starting error

Outdoor unit display	E46 1 (INVERTER1 PCB) E36 1 (INVERTER2 PCB)
Judgment Method	<ul style="list-style-type: none"> · Startup, and then if the speed increase is not normally. · Detected by H/W or S/W.
Cause of problem	<ul style="list-style-type: none"> · Compressor connection error · Defective Compressor · Defective PCB

1. Cause of problem

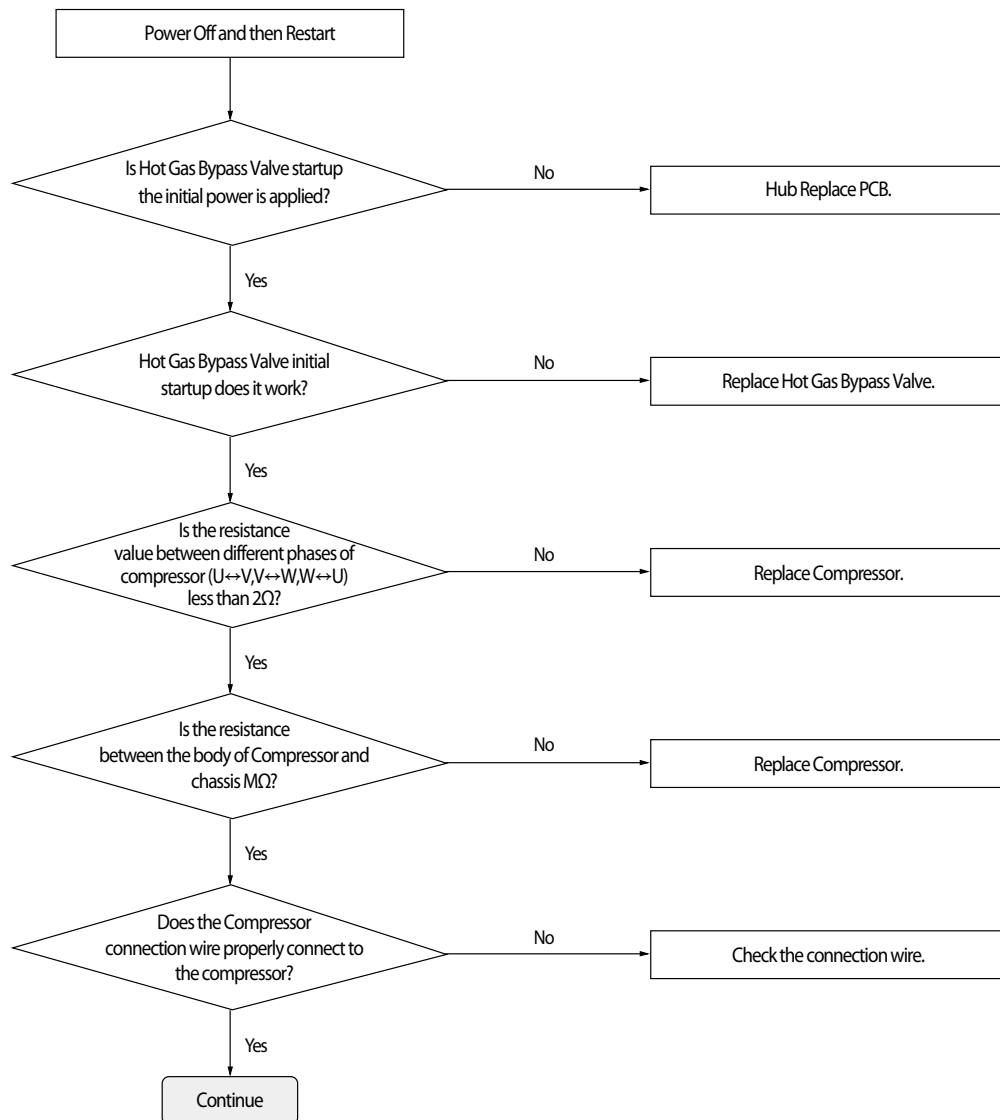

4-4-77 Inverter Overcurrent error

Outdoor unit display	<i>E464/E465</i> (INVERTER1 PCB) <i>E364/E365</i> (INVERTER2 PCB)	
Judgment Method	<ul style="list-style-type: none"> · Will occur if the overcurrent flowing in the IPM. · Detected by H/W or S/W 	
Cause of problem	<ul style="list-style-type: none"> · Installation defective · Comp. defective · PCB defective 	<ul style="list-style-type: none"> · Connection wire error · Motor defective

1. Cause of problem

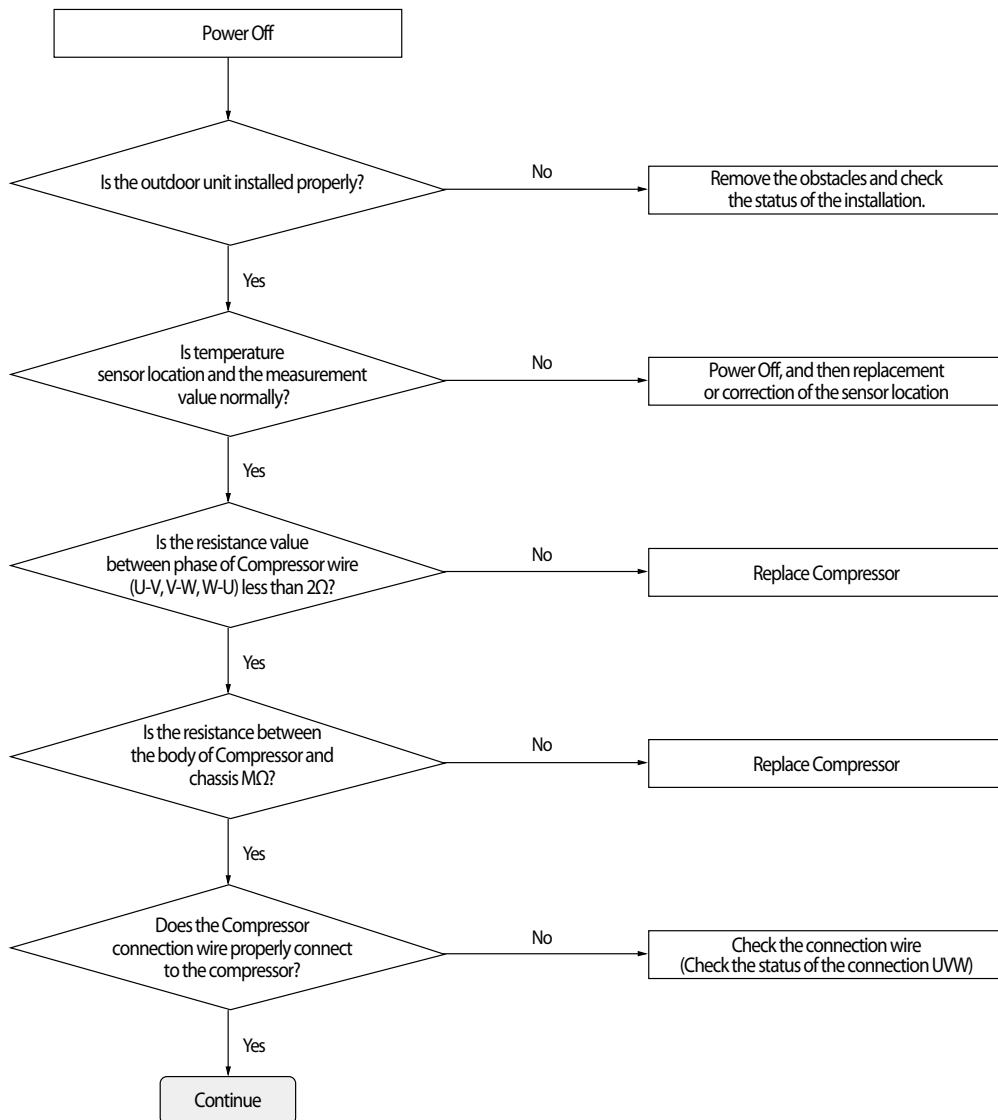

4-4-78 Overvoltage / Low voltage error

Outdoor unit display	<i>E466</i> (INVERTER1 PCB) <i>E366</i> (INVERTER2 PCB)
Judgment Method	<ul style="list-style-type: none"> · N-phase wiring error and EMI Fuse short. · DC-Link Overvoltage / Low voltage occurs.
Cause of problem	<ul style="list-style-type: none"> · Check the input wiring · EMI Fuse short

1. Cause of problem

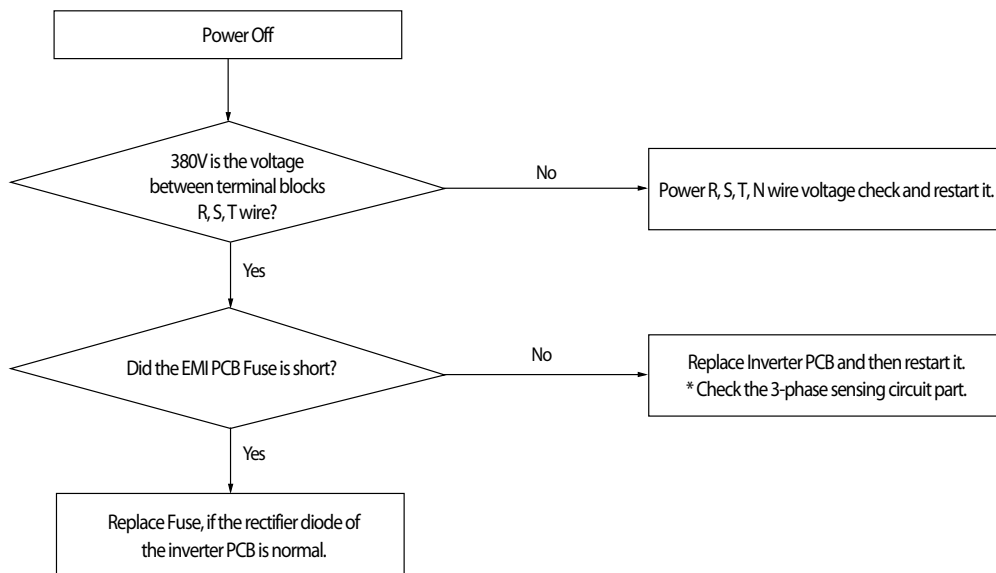

4-4-79 DC Link voltage sensor error

Outdoor unit display	<i>E469</i> (INVERTER1 PCB) <i>E369</i> (INVERTER2 PCB) <i>E496</i> (OUTDOOR FAN 1 PCB) <i>E396</i> (OUTDOOR FAN 2 PCB)
Judgment Method	· DC voltage detection : Judged as an error if the detected value is more than 2.8V or 0.2V less than
Cause of problem	· Input voltage defective · AC Power wiring error · Momentary Overvoltage / Low voltage occurs · PCB voltage sensing circuit defective

1. Cause of problem

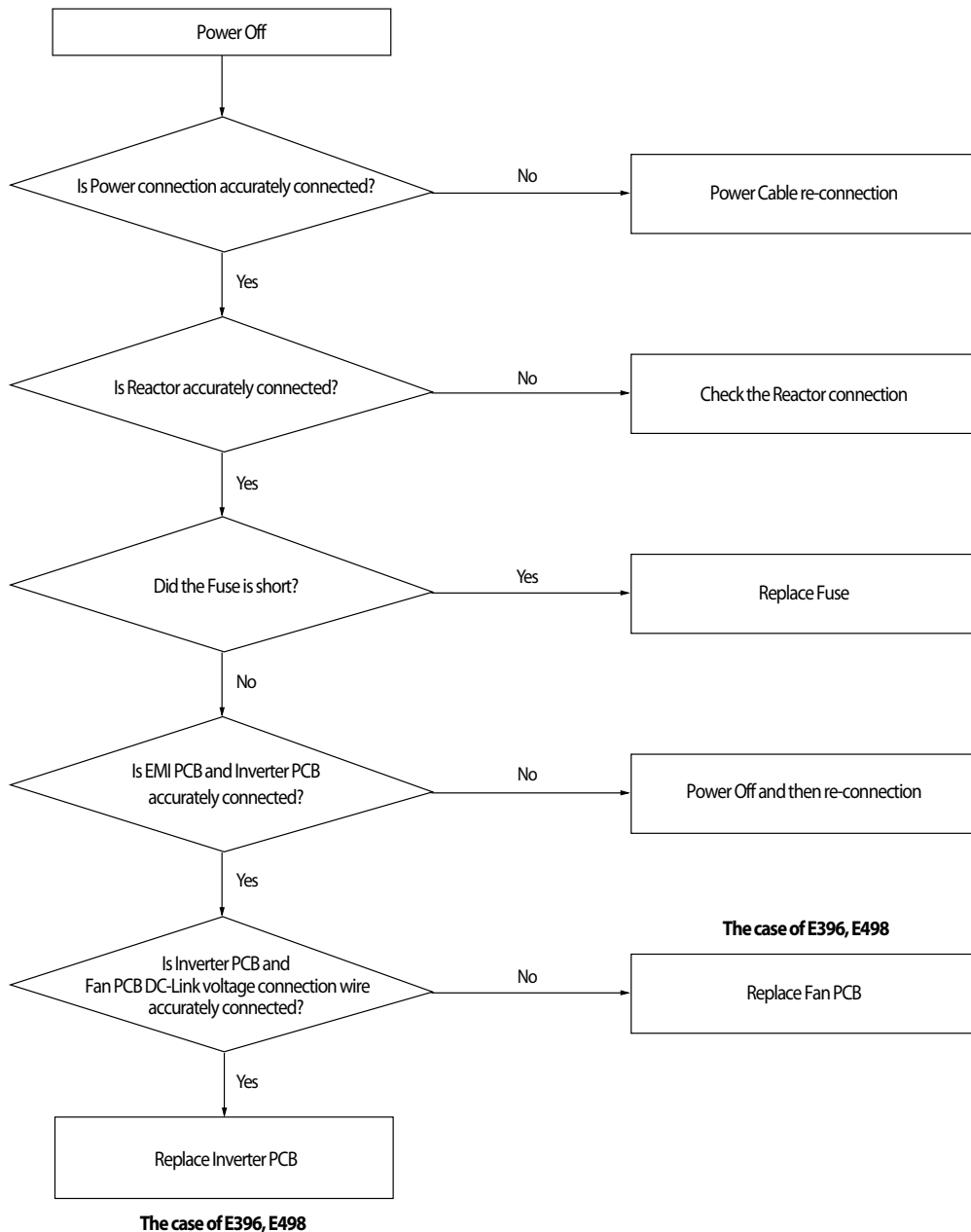

4-4-80 Liquid Compression Prevention Control

Outdoor Unit Display	E477
Indoor Unit Display	-
Judgment Method	• SUMP temperature decrease & DSH < 5°C 25 min.
Special Cause	• EVI EEV and super cooler, liquid bypass valve leakage, refrigerant overcharge, indoor unit EEV leakage, direct connection between indoor liquid pipe-gas pipe, faulty main EEV, and failure to operate compressor

1. Inspection Method

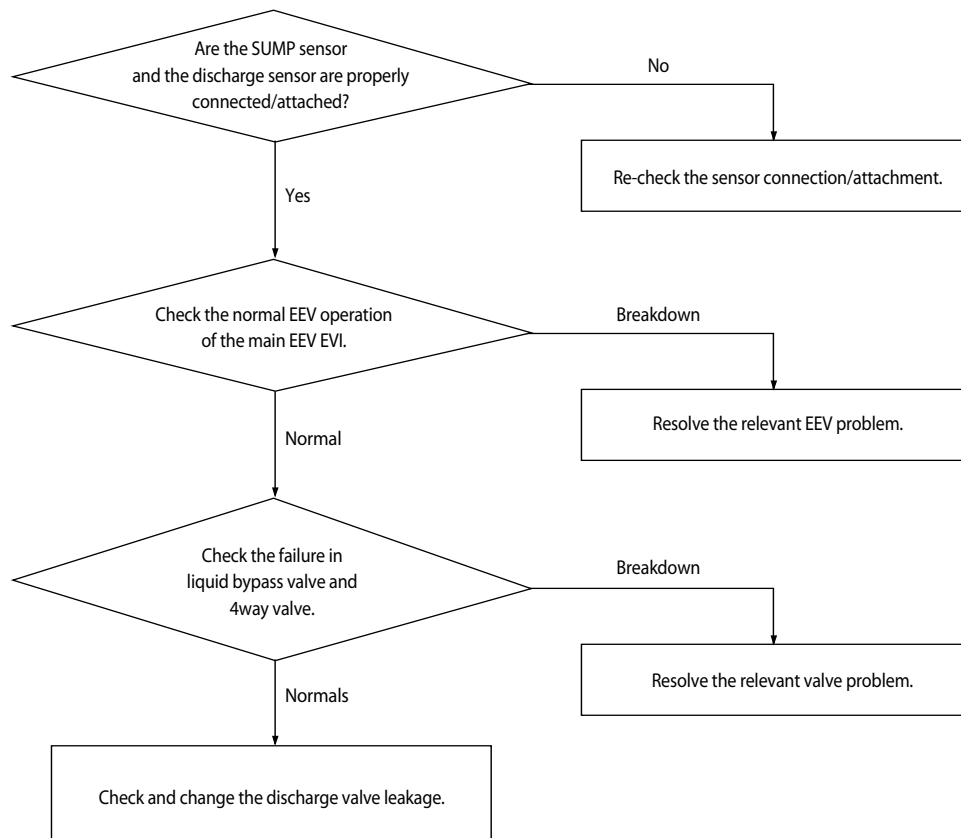

4-4-81 Fan Motor Overcurrent error

Outdoor unit display	<i>E478/E489</i> (FAN PCB(FAN1)) <i>E378/E389</i> (FAN PCB(FAN2))	
Judgment Method	<ul style="list-style-type: none"> · Occurs when overcurrent flows in the IPM. · Detected by H/W or S/W 	
Cause of problem	<ul style="list-style-type: none"> · Installation error · Defective Comp · Defective PCB 	<ul style="list-style-type: none"> · Connector error · Defective Motor

1. Cause of problem

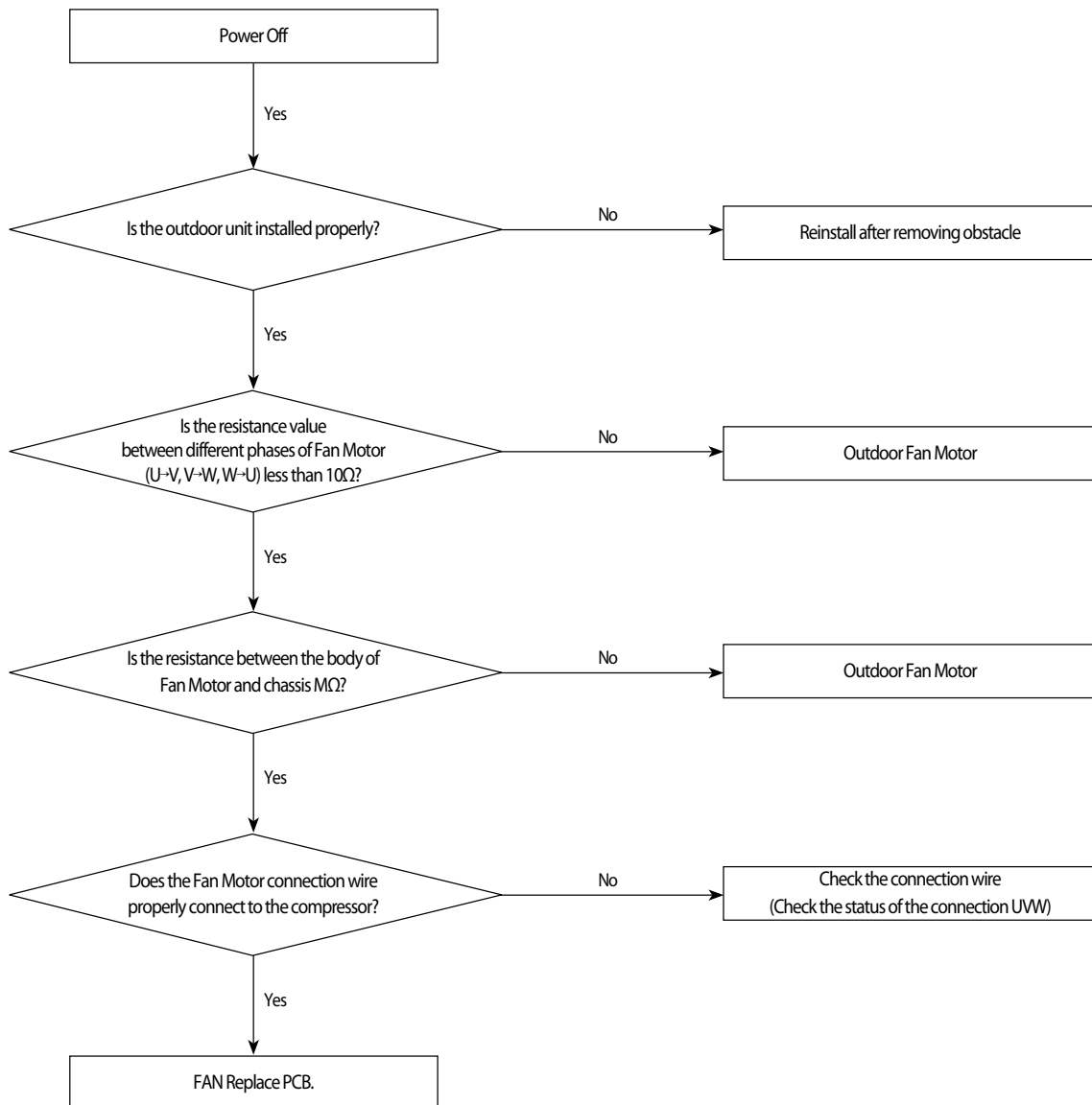

4-4-82 Input / Output Current sensor error

Outdoor unit display	<i>E485</i> INVERTER1 PCB(Input Current sensor) <i>E385</i> INVERTER2 PCB(Input Current sensor) <i>E468</i> INVERTER1 PCB(Output Current sensor) <i>E368</i> INVERTER 2 PCB(Output Current sensor) <i>E493</i> OUTDOOR FAN PCB (FAN1 Output Current sensor) <i>E393</i> OUTDOOR FAN PCB (FAN2 Output Current sensor)
Judgment Method	· Sensor Output detection : Judged as an error if the detected value is more than 2.8V or 0.2V less than
Cause of problem	· Input voltage defective · PCB voltage sensing circuit defective

1. Cause of problem

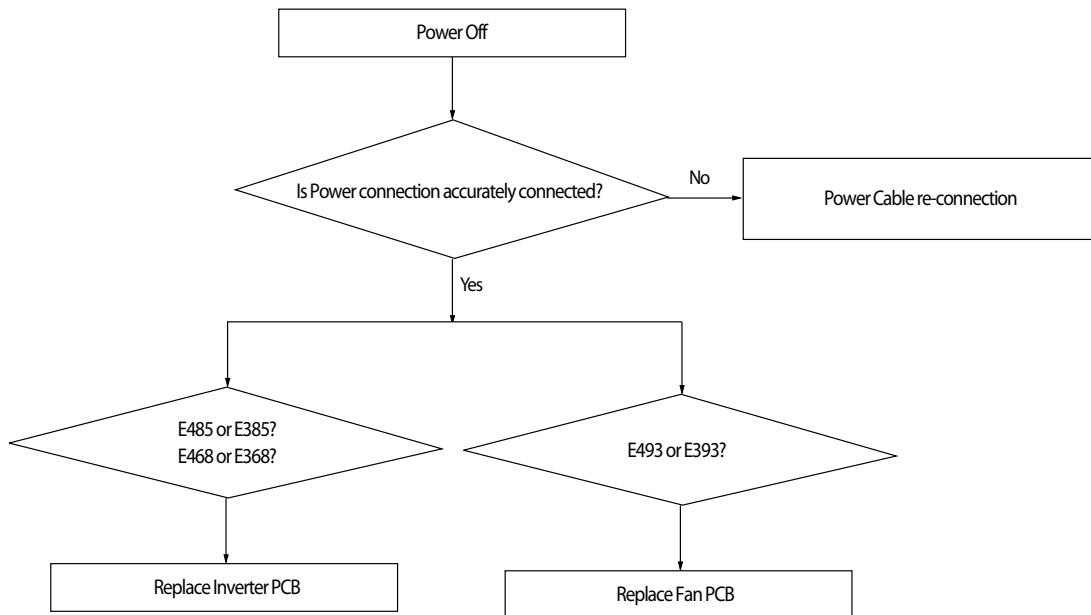

4-4-83 Outdoor Fan PCB Overvoltage / Low voltage error

Outdoor unit display	<i>E486</i>
Judgment Method	<ul style="list-style-type: none"> · N-phase wiring error and EMI Fuse short. · DC-Link Overvoltage / Low voltage occurs.
Cause of problem	<ul style="list-style-type: none"> · Check the input wiring · EMI Fuse short

1. Cause of problem

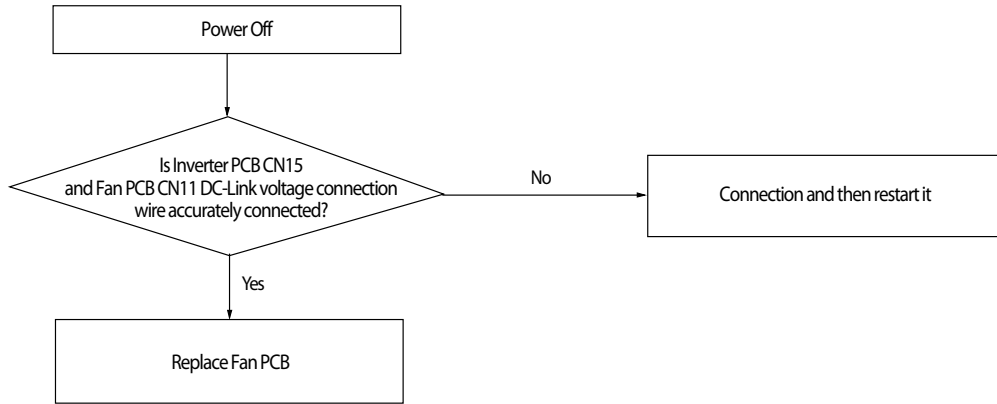

4-4-84 Hall IC(Fan) error

Outdoor Unit Display	E487 (FAN PCB(FAN1)) E387 (FAN PCB(FAN2))
Indoor Unit Display	-
Judgment Method	<ul style="list-style-type: none"> · Connection status error. · Hall IC wire disconnection. · Defective circuit parts and defective manufacturing. · Fan Motor defective.
Special Cause	<ul style="list-style-type: none"> · EVI EEV and super cooler, liquid bypass valve leakage, refrigerant overcharge, indoor unit EEV leakage, direct connection between indoor liquid pipe-gas pipe, faulty main EEV, and failure to operate compressor

1. Cause of problem

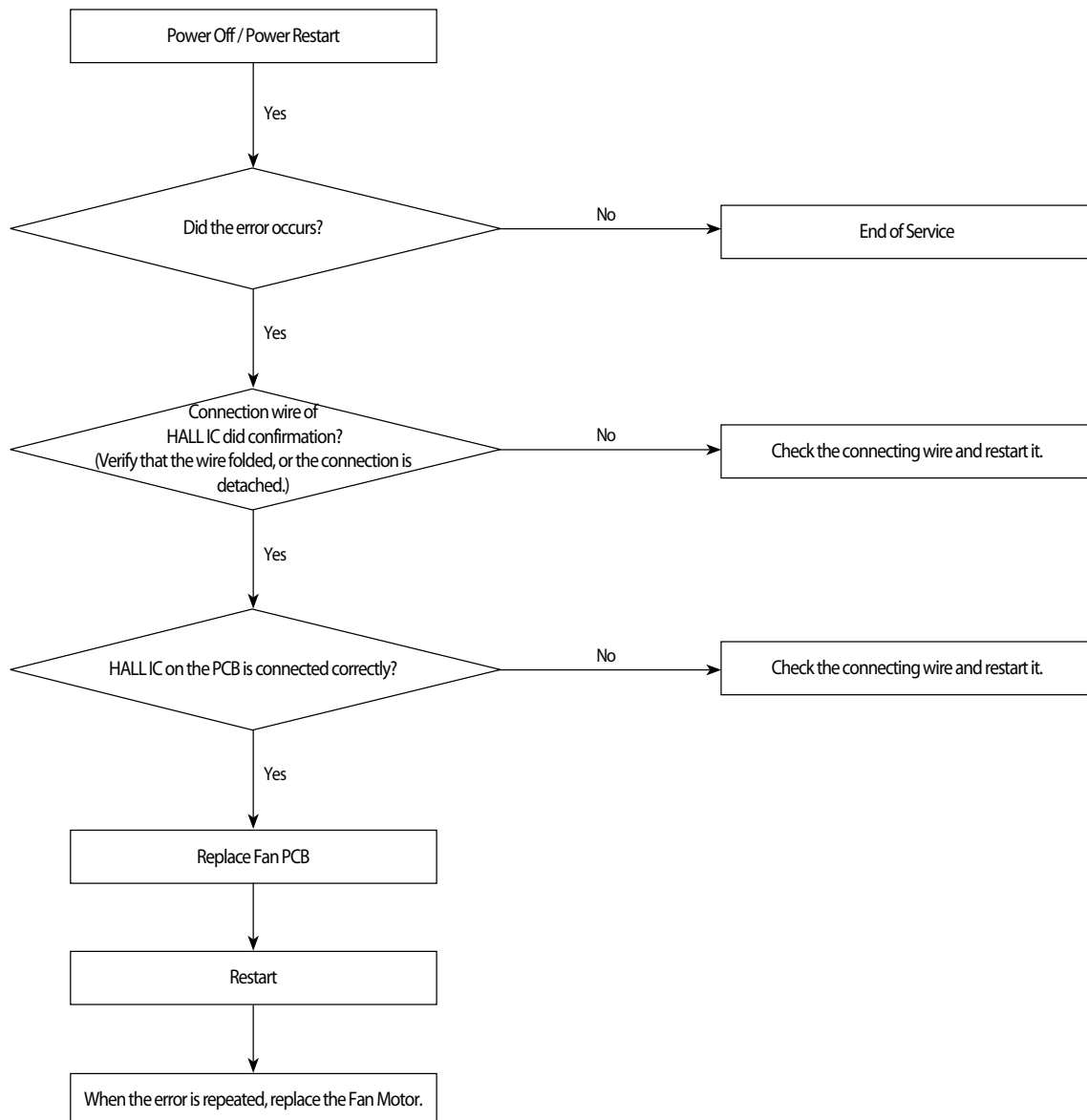

4-4-85 Inverter Overheat error

Outdoor unit display	E500 (INVERTER1 PCB) E400 (INVERTER2 PCB)
Judgment Method	· IGBT module internal temperature : 105°C more than (E500, E400)
Cause of problem	· Cooling Pin and the IGBT junction part assembly defective. · Refrigerant cooling heat sink and refrigerant piping assembly defective. · Assembled bolt defective.

Both end resistance values of IGBT module pin(8, 9 pin)

Temperature [°C]	NTC [ohm]	AD [V]	Temperature [°C]	NTC [ohm]	AD [V]
10	9000	2.58	100	500	0.55
20	6000	2.33	105	450	0.51
30	4000	2.03	110	380	0.44
40	3000	1.80	120	300	0.35
50	2000	1.47	130	250	0.30
60	1600	1.29	140	200	0.25
70	1200	1.07			
80	750	0.76			
90	650	0.68			

1. Cause of problem

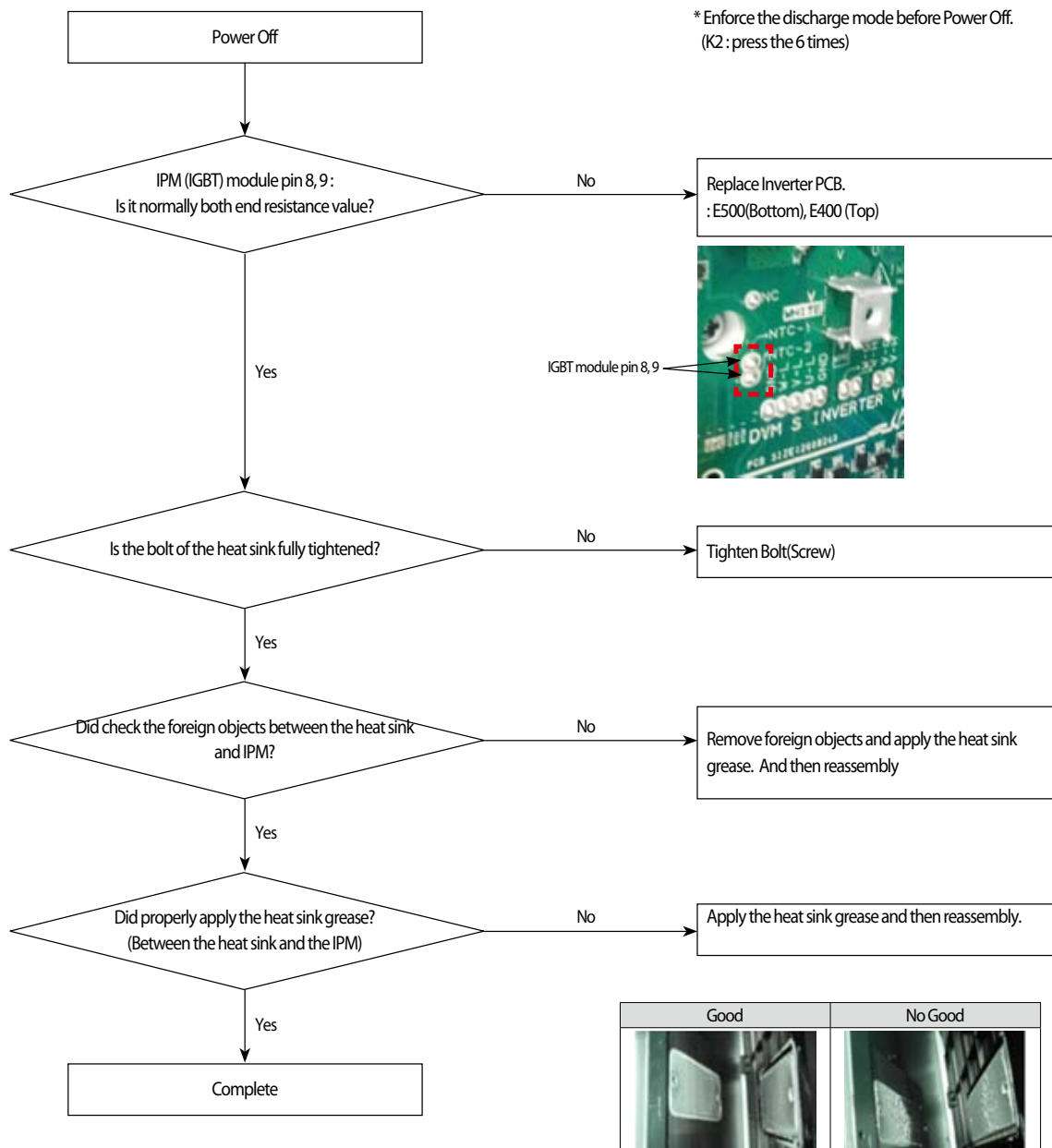

4-4-86 Model mismatching of Indoor unit.

Outdoor unit display	<i>E563</i>
Judgment Method	<ul style="list-style-type: none"> · Prior to July 2011, if the software version of the indoor unit. · Prior to July 2011, if the software version of the indoor unit.
Cause of problem	<ul style="list-style-type: none"> · Check the software version of the indoor unit. · Check whether the support of the indoor unit.

1. Cause of problem

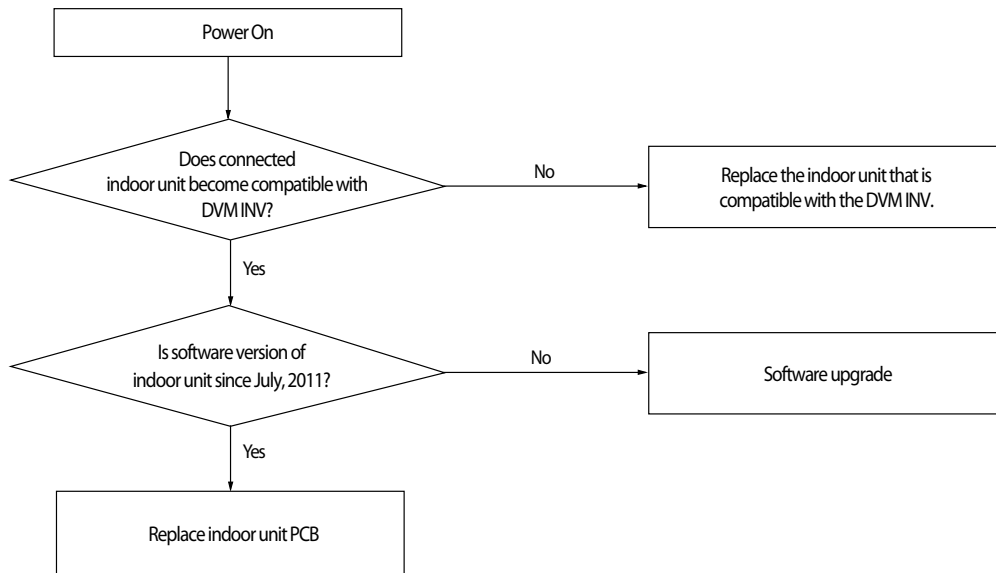

4-4-87 Breakdown of an EEV(1st)

1. How to diagnose

Detect only on cooling operation. (No detection during heating operation.)

During cooling operation, the temperature of the inlet or outlet ducts of heat exchanger is kept lower than 0°C for more than 20 minutes without cessation

2. How to check

1) Check if the wire of an electronic expansion valve is correctly connected to the PCB of indoor unit.

2) Check if the coil of an electronic expansion valve is correctly plugged into the main body.

3) Check if there is any rust on the surface of the coil of an electronic expansion valve with the naked eye, and then check the resistance between each terminal to find any wire breaking or short circuit.

4) Press the RESET KEY (K3) of the outdoor unit then see if the same error occurs.

- In case of closure problem, operate the indoor unit in which the error has occurred.

- In case of opening problem, please do not operate the indoor unit in which the error has occurred.

5) If there is no problem with the above checkup items, replace the electronic expansion valve of the troubled indoor unit.

- As an electronic expansion valve replacement is tricky work that requires collecting refrigerants in all systems, please make sure to check the above items before replacement.

4-4-87 Breakdown of an EEV closure

1. How to diagnose

1) During cooling operation (It must satisfy each of the following conditions for over 20minutes.)

Tair in - Teva in in $\geq 4^{\circ}\text{C}$	OK
Tair in - Teva out in $\geq 4^{\circ}\text{C}$	OK
Tcond, out - Tair, out $> 3^{\circ}\text{C}$	NO
Compressor in operation & Indoor unit operation & Thermo On	OK
Error details	EEV closure breakdown

2) During heating operation (It must satisfy each of the following conditions for over 20minutes.)

- When more than 2 indoor units are on Thermo On heating operating.
- When average high pressure is over 25 kg/cm²G
- 5 minutes after finishing Safety Start.
- Keep indoor units' T(Eva_IN)<T(Room)+3°C and T(Eva_Out)<T(Room)+3°C condition for more than five minutes.

2. How to check

- 1) Check if the wire of an electronic expansion valve is correctly connected to the PCB of indoor unit.
- 2) Check if the coil of an electronic expansion valve is correctly plugged into the main body.
- 3) Check if there is any rust on the surface of the coil of an electronic expansion valve with the naked eye, and then check the resistance between each terminal to find any wire breaking or short circuit.
- 4) Press the RESET KEY (K3) of the outdoor unit then see if the same error occurs.
 - In case of closure problem, operate the indoor unit in which the error has occurred.
 - In case of opening problem, please do not operate the indoor unit in which the error has occurred.
- 5) If there is no problem with the above checkup items, replace the electronic expansion valve of the troubled indoor unit.
 - As an electronic expansion valve replacement is tricky work that requires collecting refrigerant in all systems, please make sure to check the above items before replacement.

4-4-88 Electronic expansion valve closing malfunction (2nd stage)

Outdoor unit display	1 st stage inspection: <i>P702</i> (only displays on outdoor unit) 2 nd stage inspection: <i>E 152</i> ↔ <i>A^{x x x}</i> (x x x: error occurred)
Indoor unit display	×(Operation) ●(Reservation) ●(Blast) ●(Filter) ×(Defrost)
Criteria	• Please refer to determining method below
Cause of problem	• Faulty indoor unit electronic expansion valve action (valve will not open) • Address setup error in indoor unit (RAC) using EEV KIT

1. Inspection Method

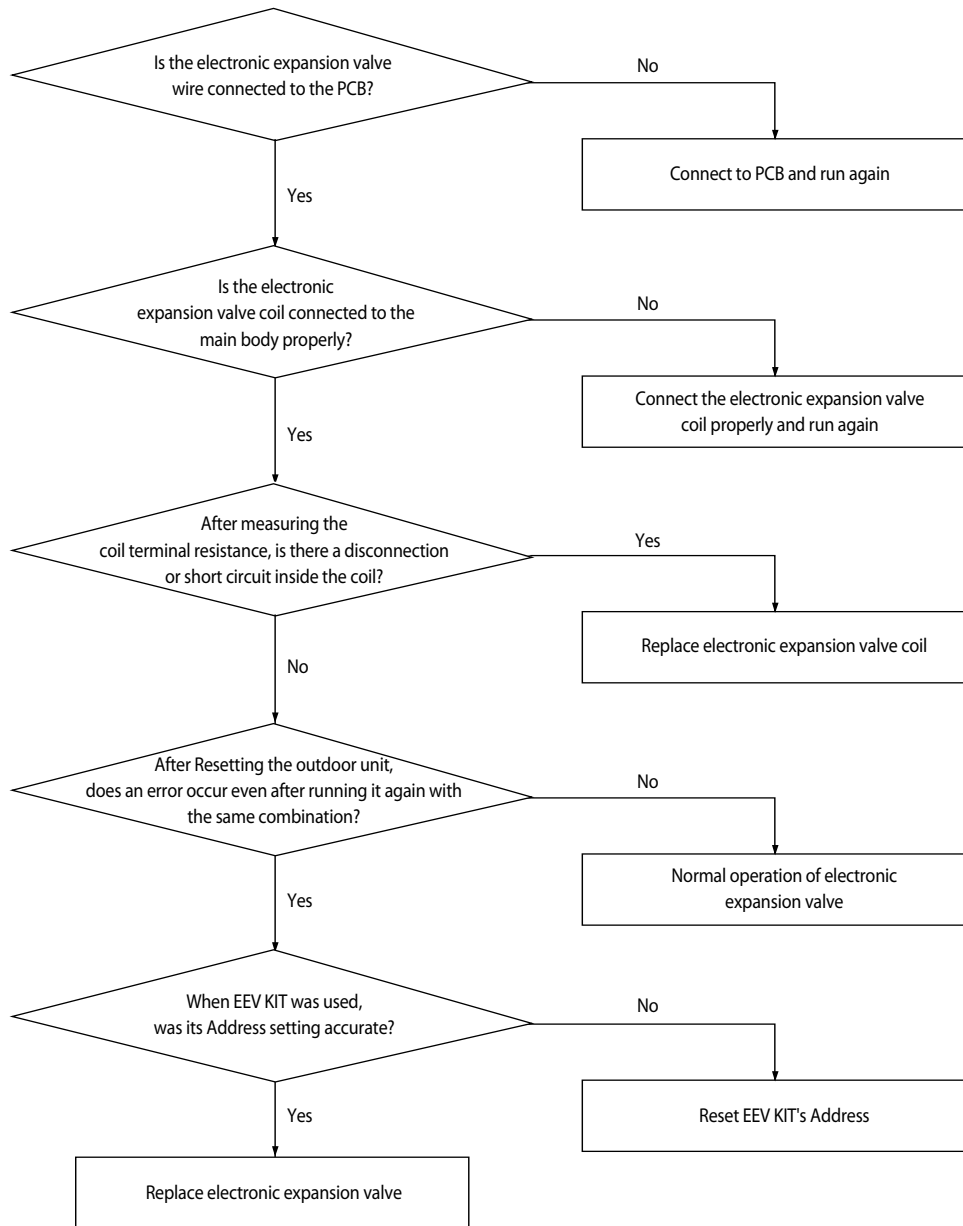

4-4-89 Electronic expansion valve opening malfunction (2nd stage)

Outdoor unit display	1 st stage inspection: <i>P703</i> (only displays on outdoor unit) 2 nd stage inspection: <i>E151</i> ↔ <i>A^{x x x}</i> (x x x: indoor unit address of where error occurred)
Indoor unit display	×(Operation) ●(Reservation) ●(Blast) ●(Filter) ×(Defrost)
Criteria	• Please refer to determining method below
Cause of problem	• Faulty indoor unit electronic expansion valve action (refrigerant will leak into the stopped indoor unit) • Address setup error in indoor unit (RAC) using EEV KIT

1. Inspection Method

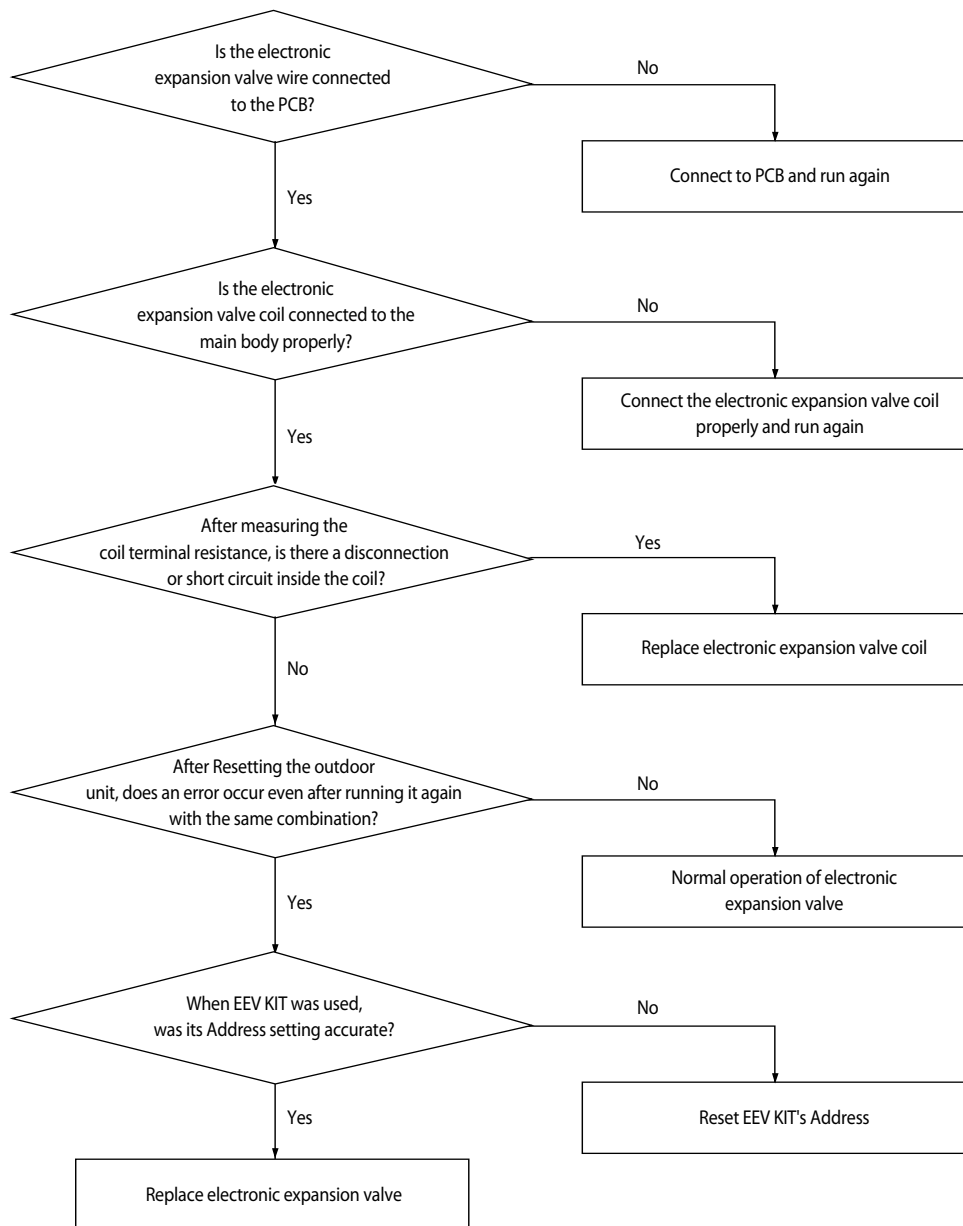

4-4-90 Hydro Unit Water In Temperature Sensor Error (Open/Short)

Outdoor unit display	<i>E901</i> → <i>A</i> XXX (xxx : Address of Indoor Unit that error occurred)
Indoor unit display	<i>E901</i>
Criteria	• Refer to the judgment method below.
Cause of problem	• Hydro Unit Water In Temperature Sensor Open/Short error of xxx

1. Inspection Method

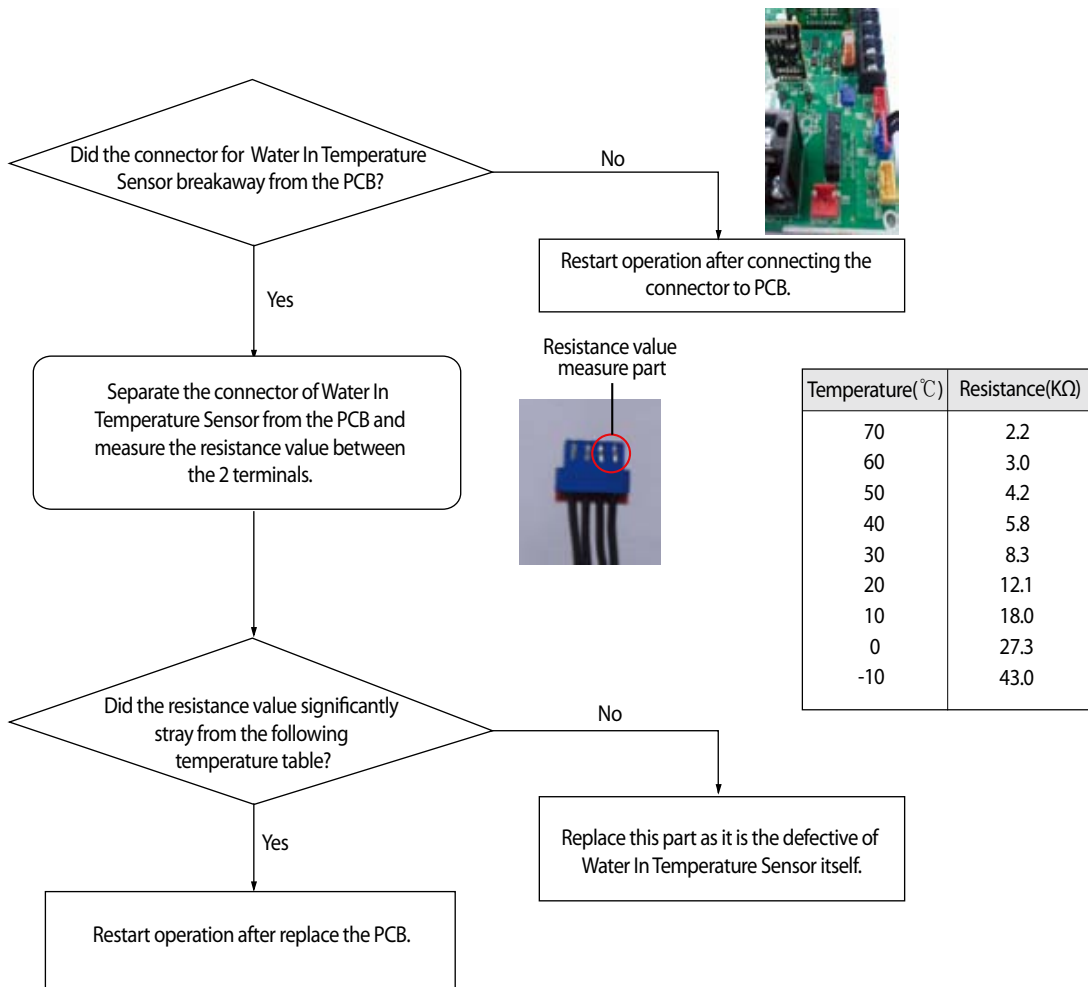

4-4-91 Hydro Unit Water Out Temperature Sensor Error (Open/Short)

Outdoor unit display	<i>E902</i> → <i>A</i> XXX (xxx : Address of Indoor Unit that error occurred)
Indoor unit display	<i>E902</i>
Criteria	• Refer to the judgment method below.
Cause of problem	• Hydro Unit Water Out Temperature Sensor Open/Short error of xxx

1. Inspection Method

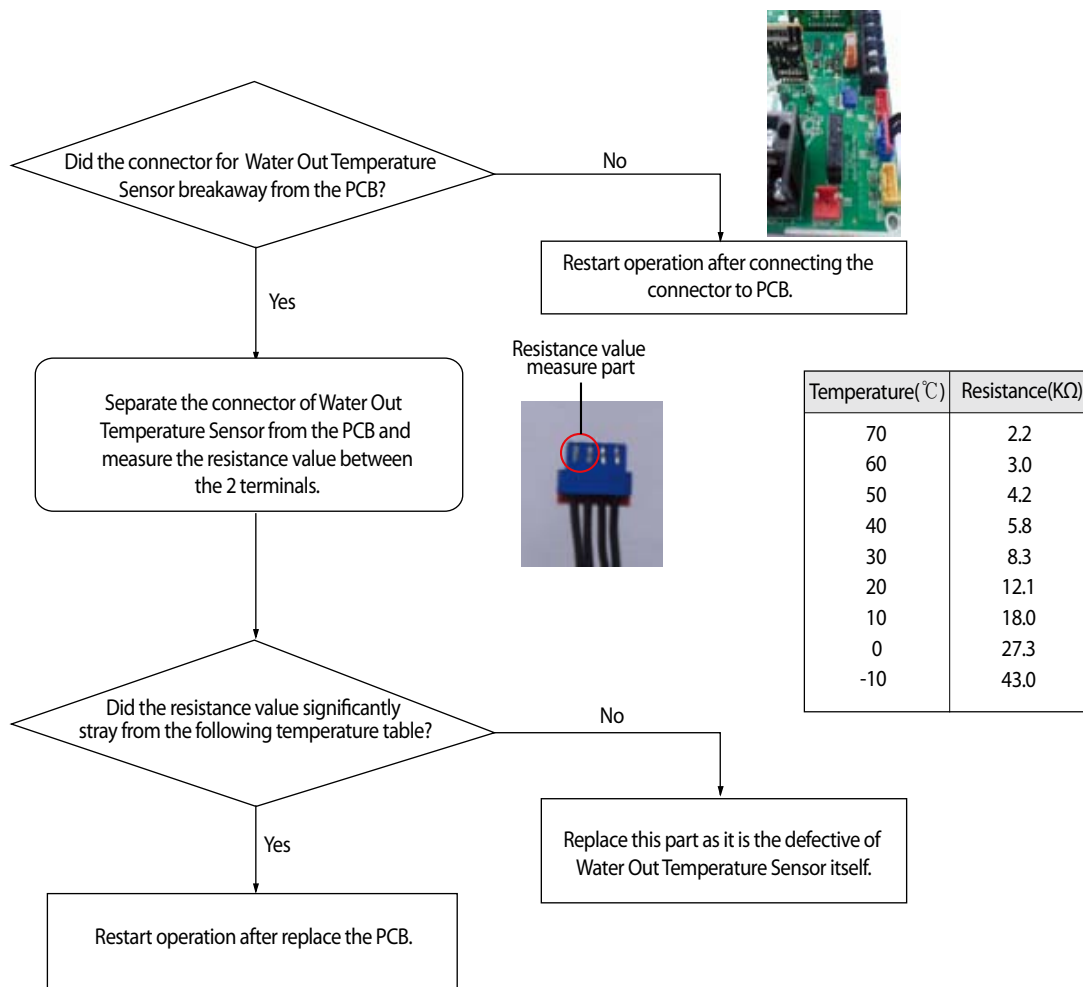

4-4-92 Hydro Unit Water Tank Temperature Sensor Error (Open/Short)

Outdoor unit display	E904 → A XXX (xxx : Address of Indoor Unit that error occurred)
Indoor unit display	E904
Criteria	• Refer to the judgment method below.
Cause of problem	• Hydro Unit Water Tank Temperature Sensor Open/Short error of xxx

1. Inspection Method

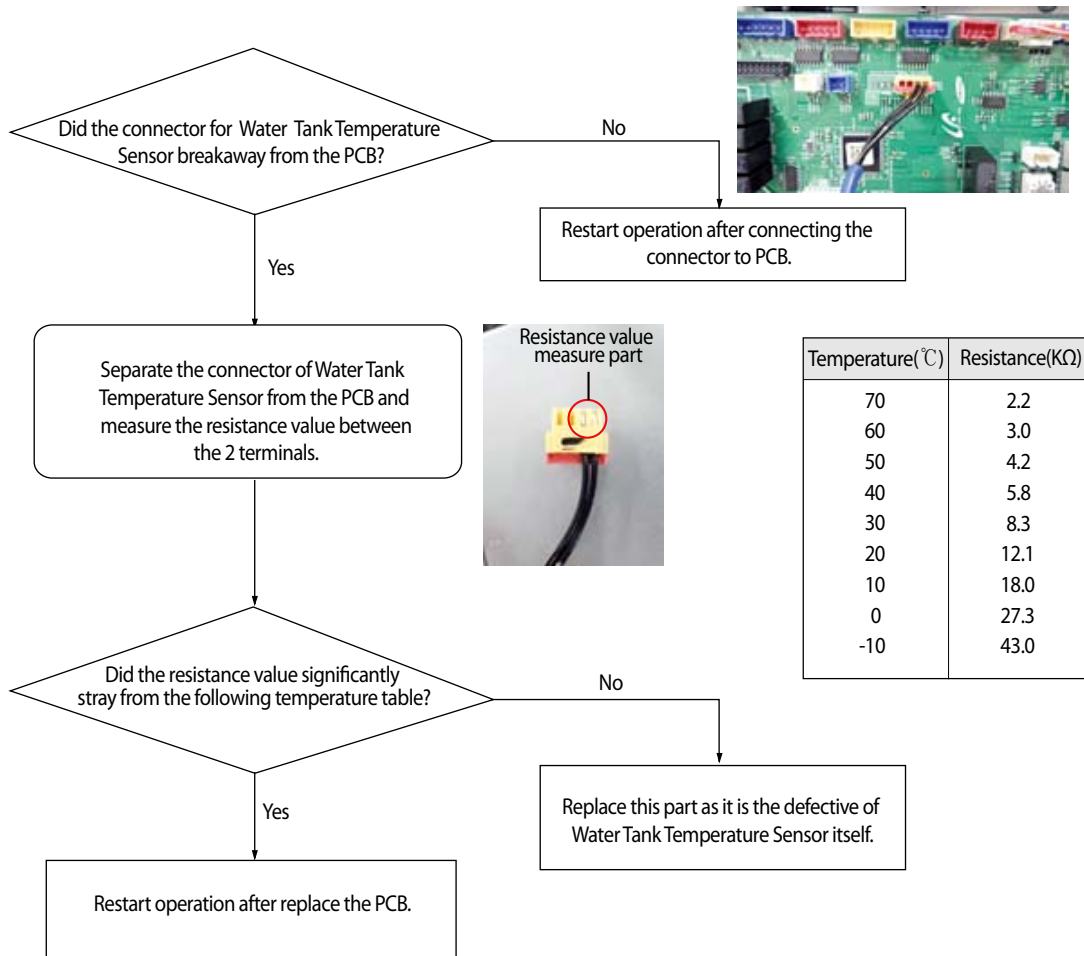

4-4-93 Emergency Error (Check the Water Piping Equipment)

Outdoor unit display	<i>E907</i> → <i>A</i> XXX (xxx : Address of Indoor Unit that error occurred)
Indoor unit display	<i>E907</i>
Criteria	• More than 2 hours Heating / Hot water operation : Water In temperature does not change more than 5°C .
Cause of problem	• Heating / Hot water operation of xxx Hydro Unit : There is no change in the water temperature.

1. Inspection Method

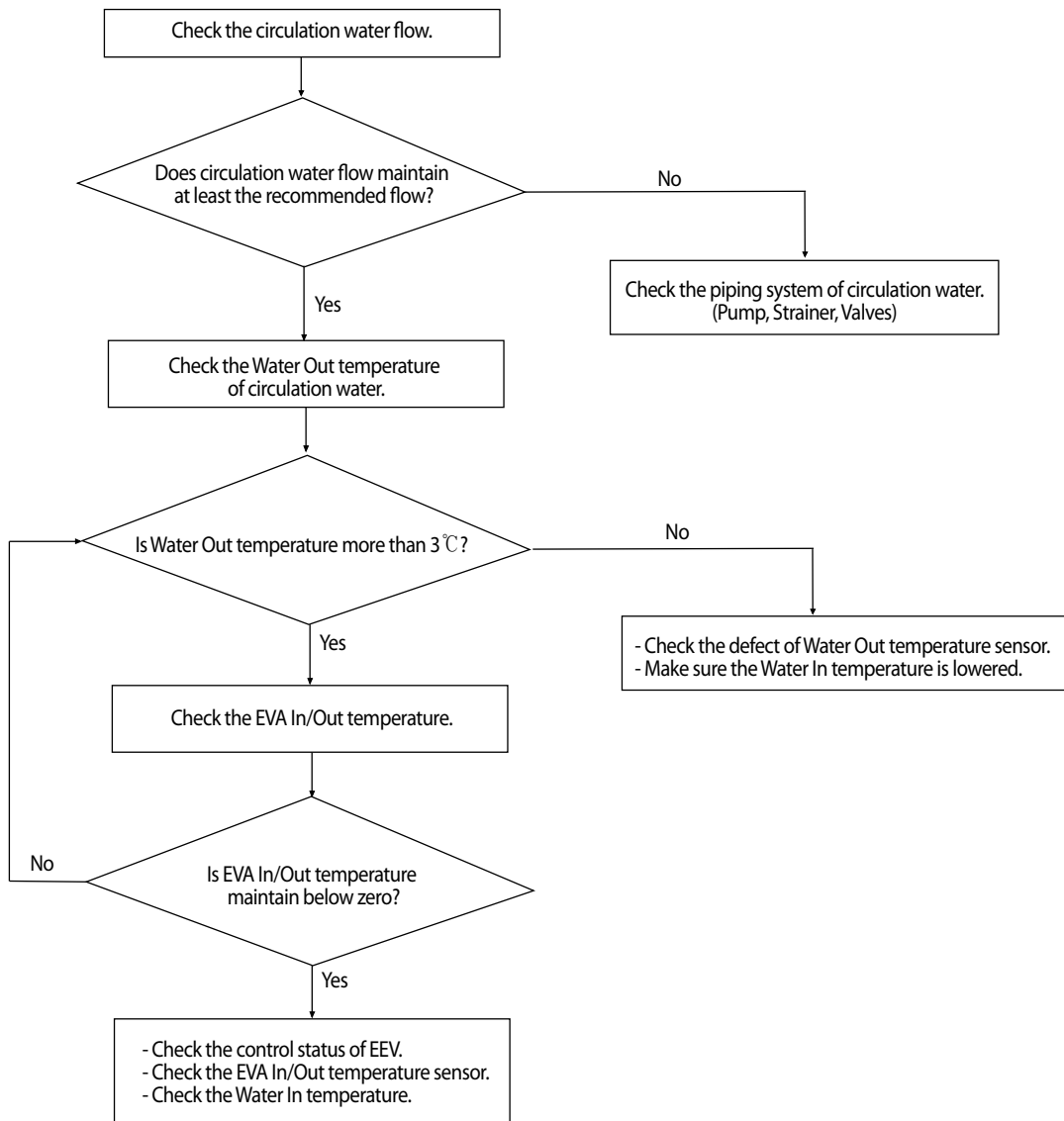

4-4-94 Error to prevention from freezing and bursting of Heat Exchanger

Outdoor unit display	<i>E908/E909</i> → A XXX (xxx : Address of Indoor Unit that error occurred)
Indoor unit display	<i>E908/E909</i> (Repeats six times)
Criteria	<ul style="list-style-type: none"> . Water Out temperature is less than 3°C . . EVA In/Out maintains the temperature below zero. (* During the cooling operation, can be detected)
Cause of problem	<ul style="list-style-type: none"> • Low Heat Exchanger internal temperature of xxx Hydro Unit. (Low flow / Low water temperature)

1. Inspection Method

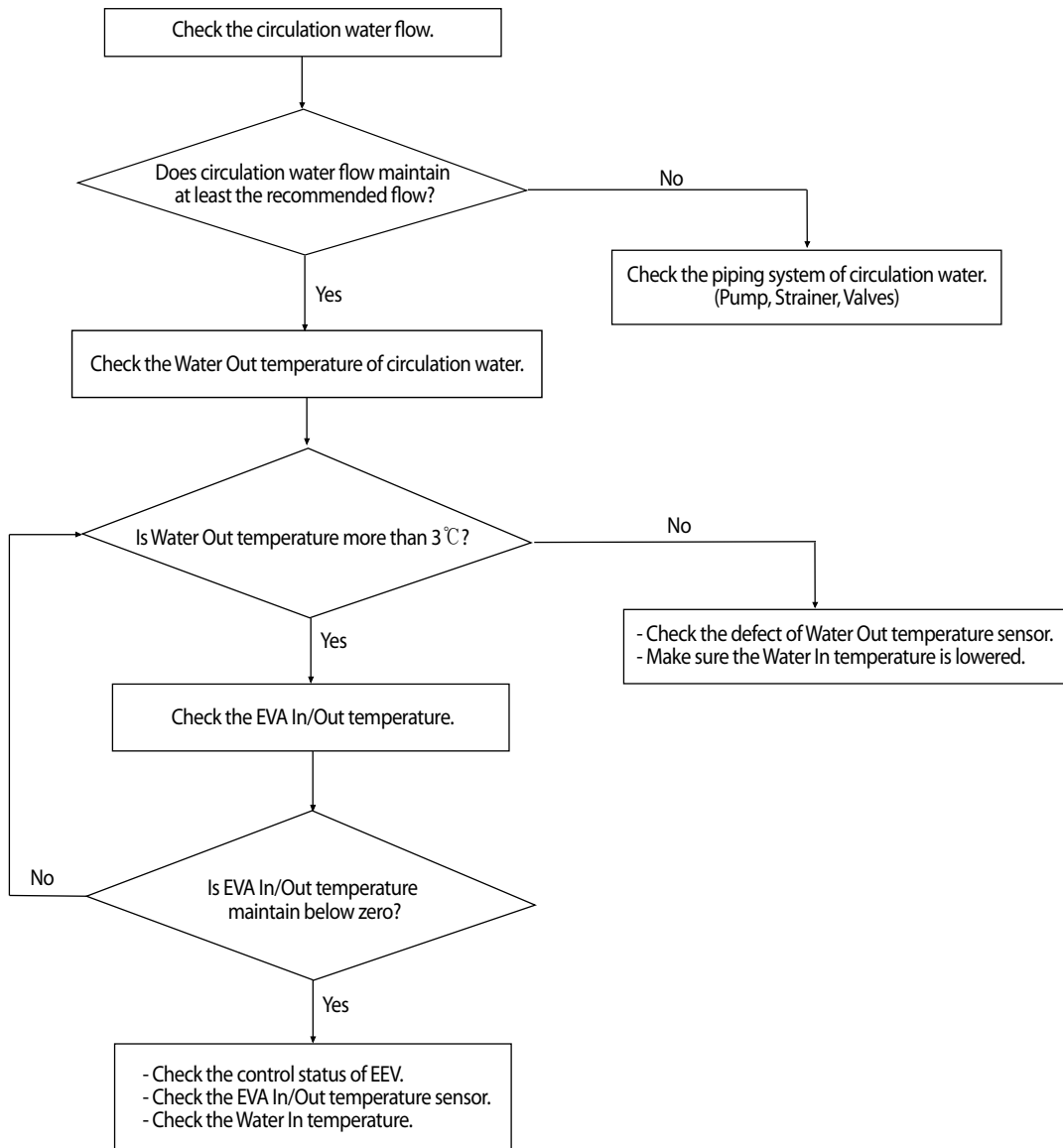

4-4-95 Breakaway of Water Out temperature sensor

Outdoor unit display	<i>E9 10</i> → <i>A</i> XXX (xxx : Address of Indoor Unit that error occurred)
Indoor unit display	<i>E9 10</i>
Criteria	. Water Out temperature before and after the operation : Temperature difference is less than 2°C .
Cause of problem	• Water Out temperature sensor breakaway of xxx Hydro Unit.

1. Inspection Method

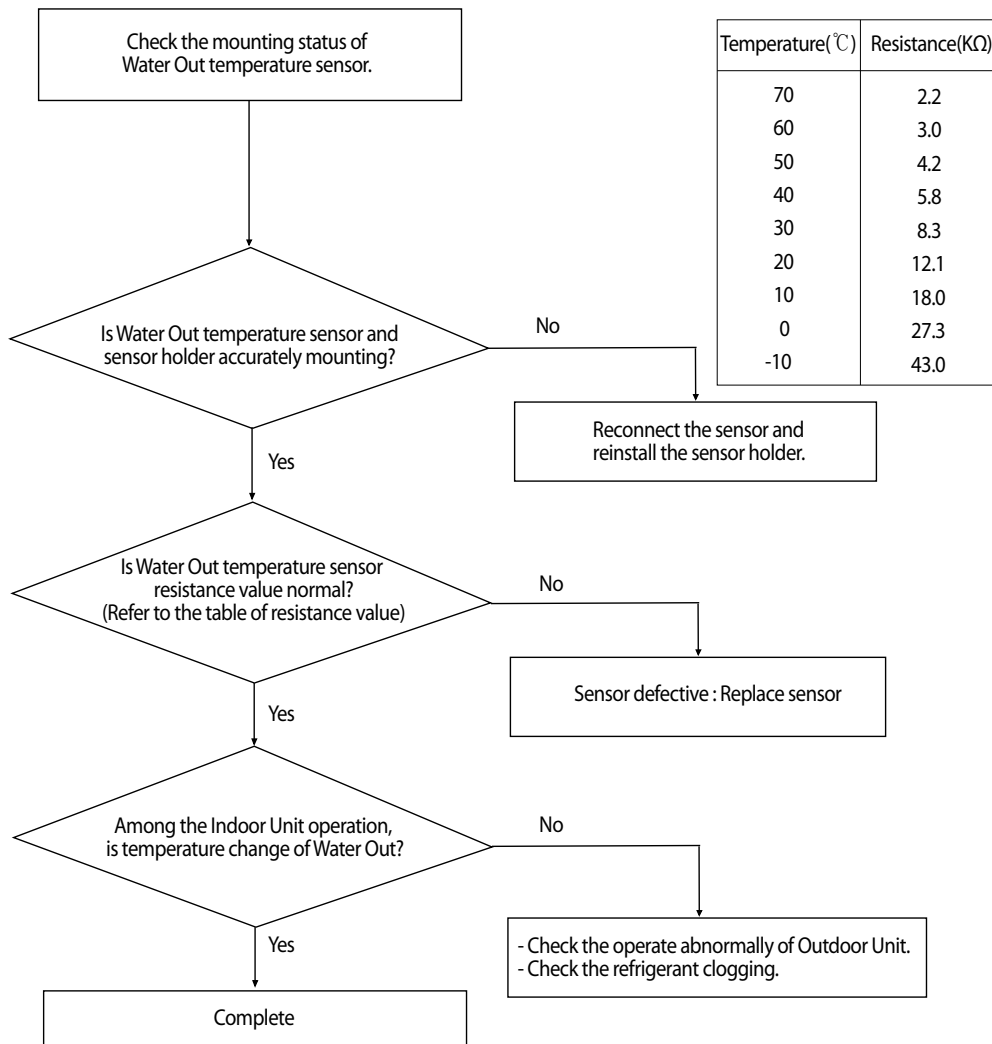

4-4-96 Breakaway of Flow switch

Outdoor unit display	<i>E911/E913</i> → <i>A</i> XXX (xxx : Address of Indoor Unit that error occurred)
Indoor unit display	<i>E911/E913</i> (Repeats six times)
Criteria	. Output status from Pump signal : Does not detect the signal of Flow Switch, more than 5 seconds.
Cause of problem	• Does not detect the signal of xxx Hydro Unit Flow Switch. (Flow shortage of Water piping system)

1. Inspection Method

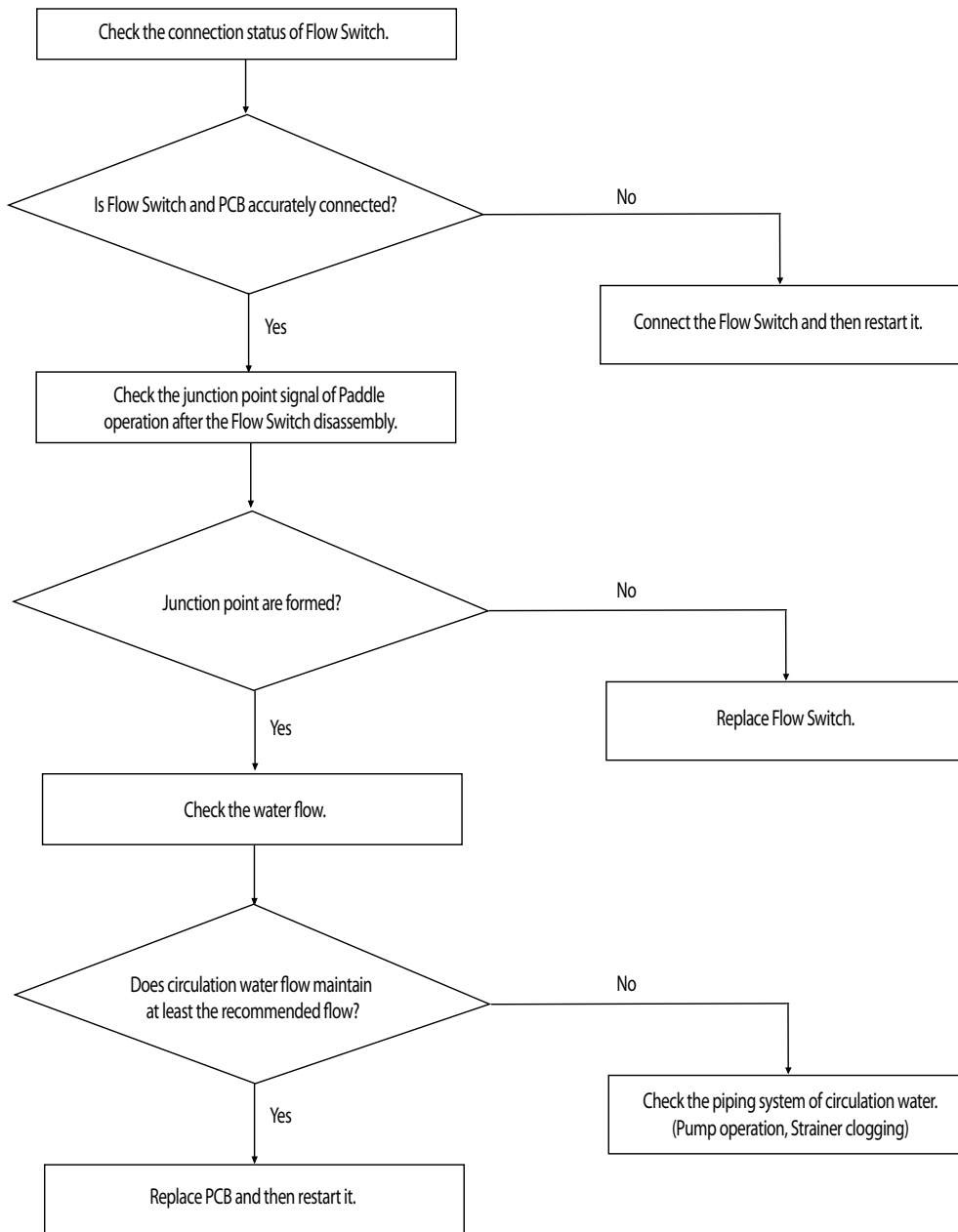

4-4-97 Thermostat Wiring Error

Outdoor unit display	<i>E9 14</i> → <i>A</i> XXX (xxx : Address of Indoor Unit that error occurred)
Indoor unit display	<i>E9 14</i>
Criteria	• Heating / Cooling signal of Thermostat at the same time input.
Cause of problem	• Thermostat wiring error of xxx Hydro Unit.

1. Inspection Method

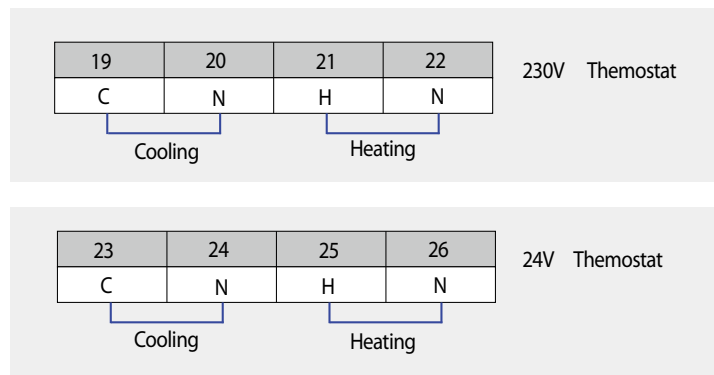
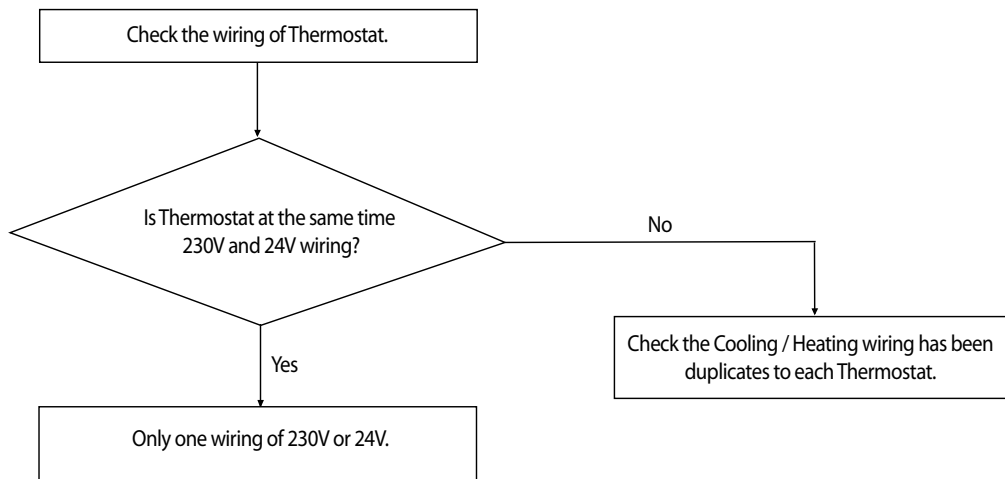

4-4-98 DC FAN Motor Feedback Error

Outdoor unit display	<i>E9 15</i> → <i>A</i> XXX (xxx : Address of Indoor Unit that error occurred)
Indoor unit display	<i>E9 15</i>
Criteria	<ul style="list-style-type: none"> Refer to the judgment method below.
Cause of problem	<ul style="list-style-type: none"> DC FAN connector defects and connection is not DC FAN motor defective. Control kit PBA defective.

1. Inspection Method

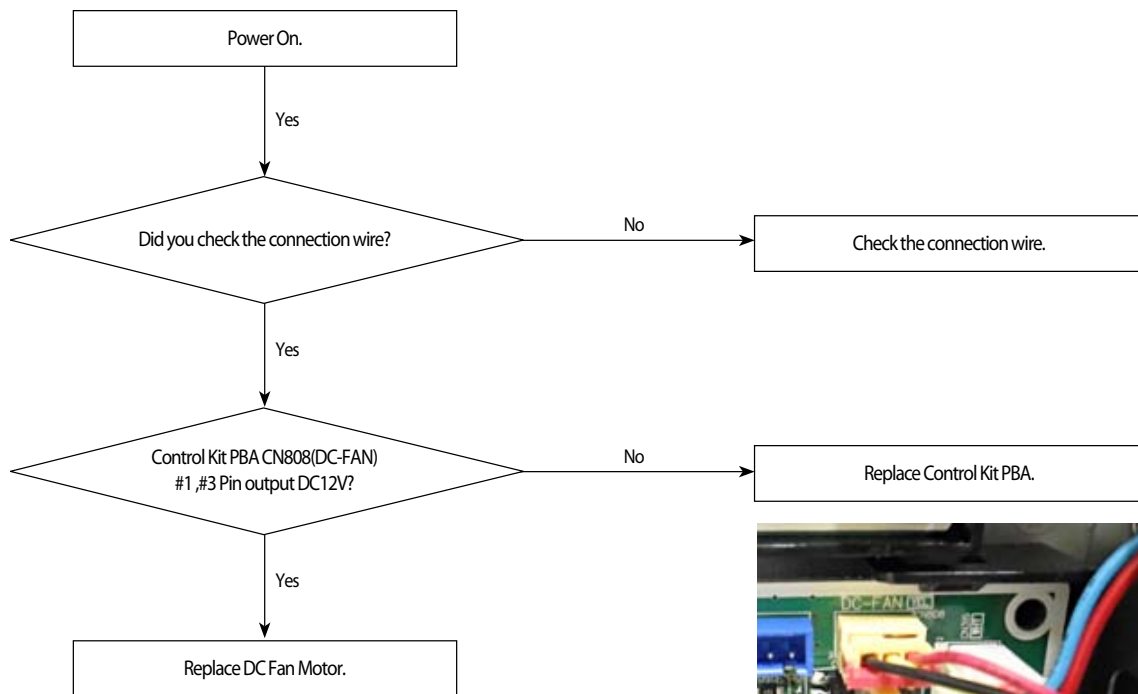

4-4-99 Water Tank Sensor defective

Outdoor unit display	<i>E9 17</i> → <i>A</i> XXX (xxx : Address of Indoor Unit that error occurred)
Indoor unit display	<i>E9 17</i>
Criteria	• Refer to the judgement method below.
Cause of problem	• Water Tank Sensor defective

1. Inspection Method

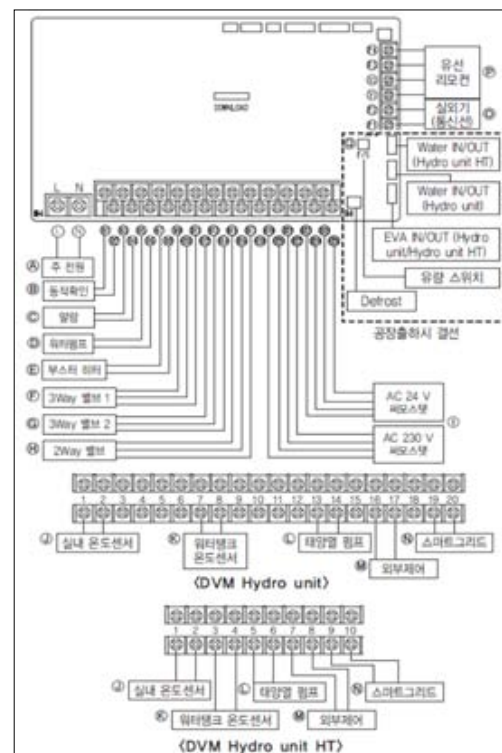
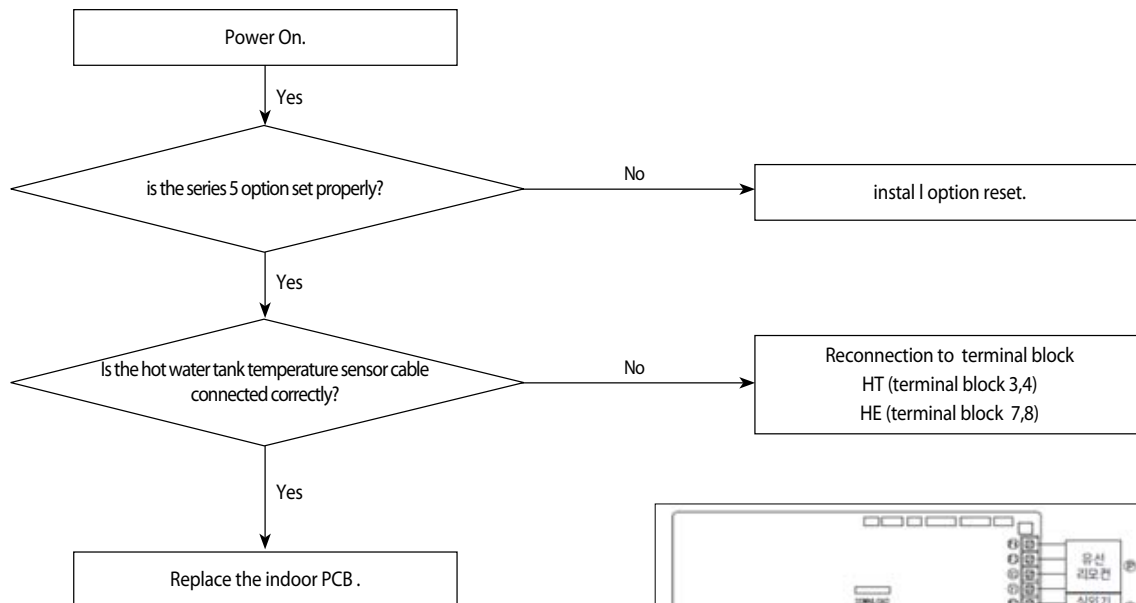

5. PCB Diagram and Parts List

5-1 Indoor Unit

5-1-1 Wind-free 4way cassette type, mini 4way cassette

- Main PBA (AM045/056/071/090/112/128/140NN4DEH*)
(AM015/022/028/036/045/056/060NNNDEH*)
(AM009/012/018/024/036/048NN4DCH/**)
(AM005/007/009/012/018/020NNNDCH/**)

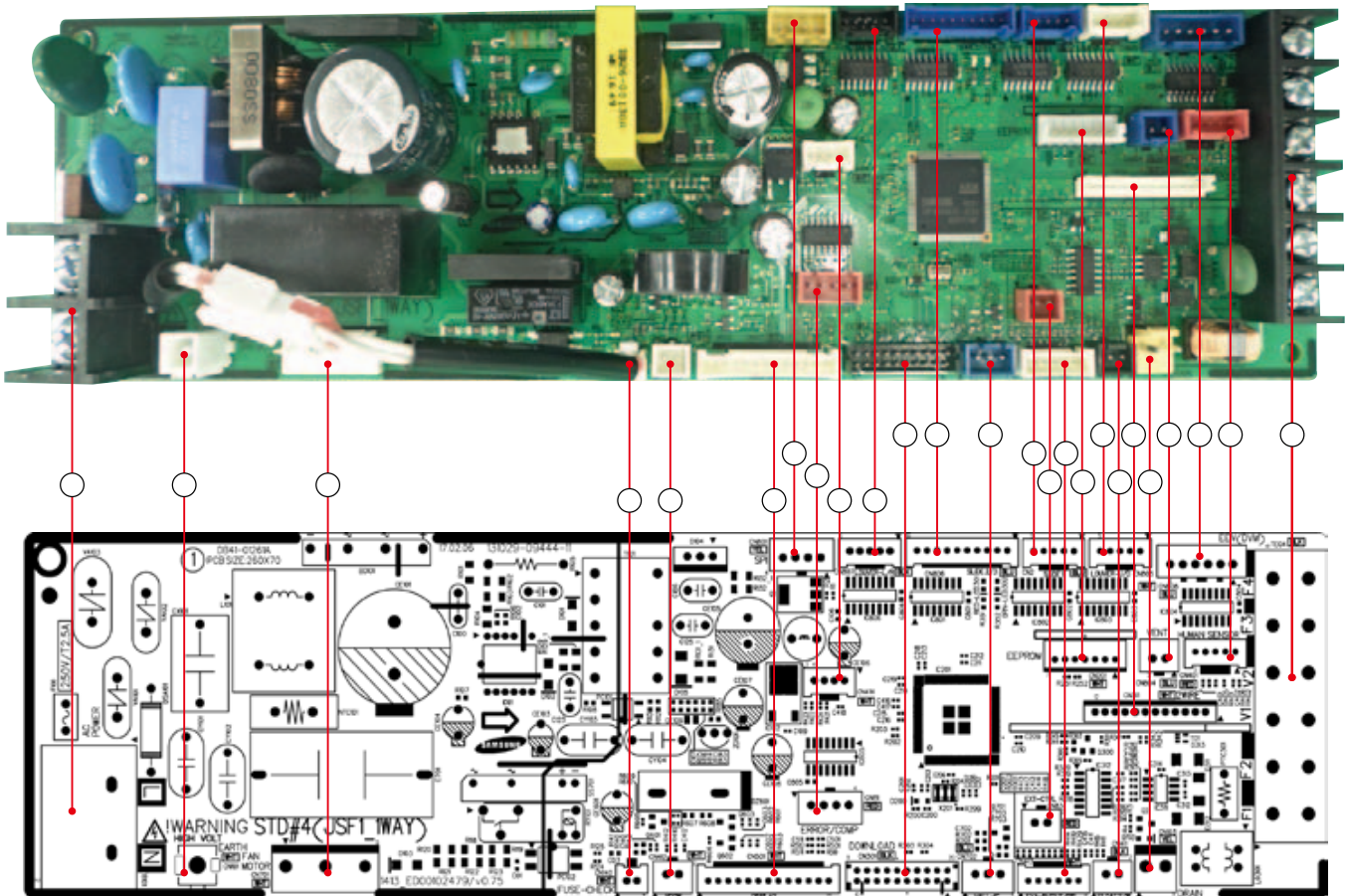

Wind-free 4way cassette type (Cont.)**- Main PBA (AM045/056/071/090/112/128/140NN4DEH**)****(AM009/012/018/024/036/048NN4DCH/**)****(AM005/007/009/012/018/020NNNDCH/**)**

① TB101-AC POWER #1: AC POWER(L) #2: AC POWER(N)	② CN101-GND #1: GND	③ CN701-BLDC MOTOR #1: POWER(N) #3: SSR MOTOR POWER(L) #5: POWER(N)	④ CN140-FUSE CHECK #1: FUSE CHECK SIGNAL #2: GND
⑤ CN412-THERMISTOR #1: ROOM TEMPERATURE SENSOR #2: GND	⑥ CN501- 디스플레이부 #1: DC12V #2: LED_0 #3: LED_1 #4: LED_2 #5: LED_3 #6: LED_4 #7: LED_5 #8: REMOCON OUTUPUT SIGNAL #9: AUTO SWITCH #10: REMOCON INPUT SIGNAL #11: GND #12: DC5V #13: GND	⑦ CN801-SPI #1: GND #2: GND #3: SPI CONTROL SIGNAL	⑧ CN414-HUMIDITY SENSOR #1: DC5V #2: GND #3: TEMPERATURE SENSOR #4: HUMIDITY SENSOR
⑨ CN81- ERROR/COMP CHECK #1: DC12V #2: ERROR CHECK(GND) #3: DC12V #4: COMP/OPER. CHECK(GND)	⑩ CN807-LOUVER L/R #1: DC12V #2~#5: LOUVER CHECK	⑪ CN301- DOWNLOAD	⑫ CN807-LOUVERS #1: DC12V #2~#5: LOUVER CHECK #6: DC12V #7~#10: LOUVER CHECK
⑬ CN702-HALL IC #1: DC5V #2: GND #3: MOTOR FEEDBACK SIGNAL	⑭ CN83- EXTERNAL CONTROL #1: GND #2: EXTERNAL CONTROL SIGNAL	⑮ CN806-LOUVER3/4 #1: DC12V #2~#5: LOUVER CHECK	⑯ CN413:THERMISTOR #1: EVA-IN TEMPERATURE SNESOR #2: GND #3: EVA-OUT TEMPERATURE SNESOR #4: GND #5: DISCHARGE TEMPERATURE SNESOR #6: GND
⑰ CN201-EEPROM #1: GND #3: DC5V #4: EEPROM_SELECT #5: EEPROM_SO #6: EEPROM_SI #7: EEPROM_CLK	⑱ CN805-LOUVER1/2 #1: DC12V #2~#5: LOUVER CHECK	⑲ CN411-FLOAT SWITCH #1: F/S SIGNAL #2: GND	⑳ CN103-DRAIN PUMP #1: D/ P POWER(DC12V) #2: GND
㉑ CN804-VENTILATOR #1: DC12V #2: VENT CONTROL SIGNAL	㉒ CN311-2 선리모컨	㉓ CN808-EEV #1~#4: EEV CHECK #5: DC12V #6: DC12V	㉔ CN401- CLEAN PANEL COMMUNICATION #1: DC12V #2: CLEAN PANEL COMMUNICAITON(TXD) #3: CLEAN PANEL COMMUNICAITON(RXD) #4: GND
㉕ TE04-COMMUNICATION #1: COM1(F1) #2: COM1(F2) #3: V1(DC12V) #4: V2(GND) #5: COM2(F3) #6: COM2(F4)			

Wind-free 4way cassette type, mini 4way cassette (Cont.)

- Display PBA (AM045/056/071/090/112/128/140NN4DEH*)
- (AM015/022/028/036/045/056/060NNNDEH*)
- (AM009/012/018/024/036/048NN4DCH/**)
- (AM005/007/009/012/018/020NNNDCH/**)

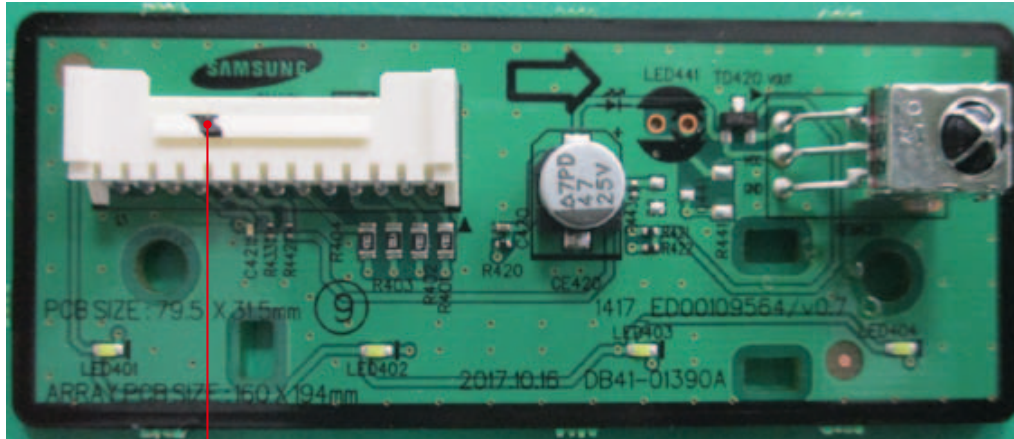

①

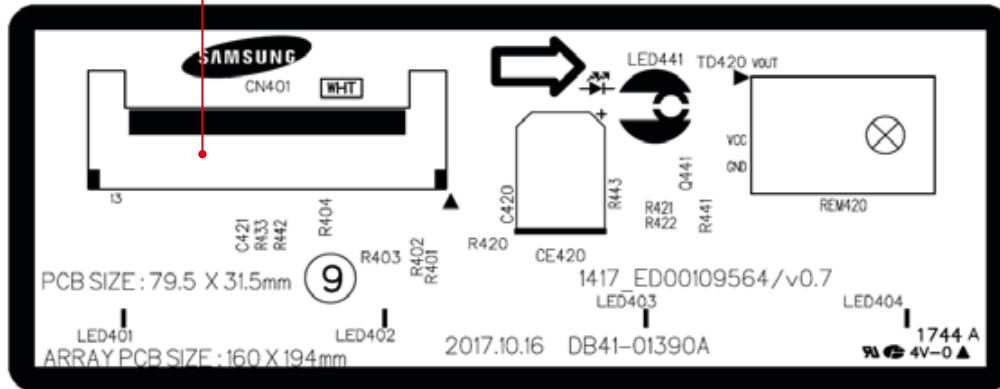

①	CN01-DISPLAY
#1:	DC12V
#2:	LED_Operation
#3:	LED_Defrost
#4:	LED_Timer
#5:	-
#6:	LED_Filter
#7:	-
#8:	Remocon Signal Out
#9 :	Panel Select
#10:	Remocon signal In
#11:	GND
#12:	DC5V
#13:	-

6. Wiring Diagram

6-1 Indoor

6-1-1 Wind-free 4way cassette type

- AM045/056/071/090/112/128/140NN4DEH/**
- AM009/012/018/024/036/048NN4DCH/**
- AM005/007/009/012/018/020NNNDCH/**

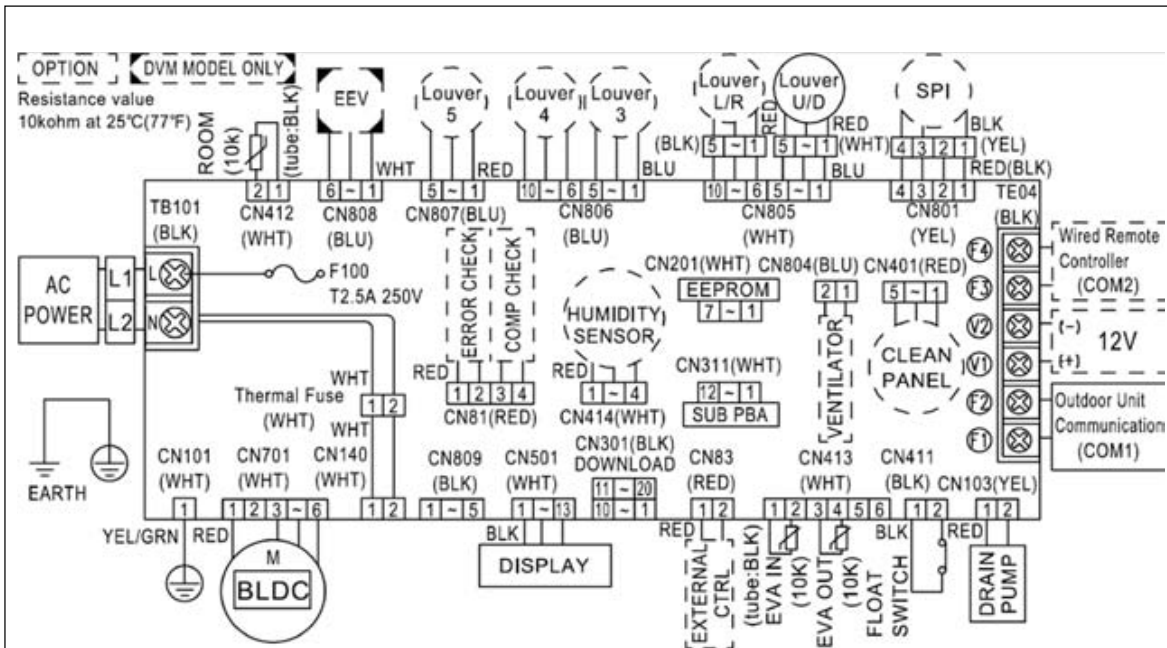

F100	FUSE	EEV	Electronic expansion valve	EVA-IN(10K)	Thermistor EVA IN(10K)
M [BLDC]	Motor (IDU fan)	SPI	S-Plasma ion	EVA-OUT(10K)	Thermistor EVA OUT(10K)
Thermal Fuse	Terminal Block thermal fuse	ROOM(10K)	Thermistor ROOM(10K)		

NOTES

1. This wiring diagram applies only to the indoor unit.
2. Symbols show as follow :
BLK : black, RED : red, BLU : blue, WHT : white, YEL : yellow, BRN : brown, SKY : sky blue, GRN : green
3. For connection wiring indoor-outdoor transmission F1-F2, indoor-wired remote controller transmission F3-F4.
4. Protective earth (SCREW).

This Document can not be used without Samsung's authorization.

7. Reference Sheet

7-1 Index for Model Name

7-1-1 Indoor Unit

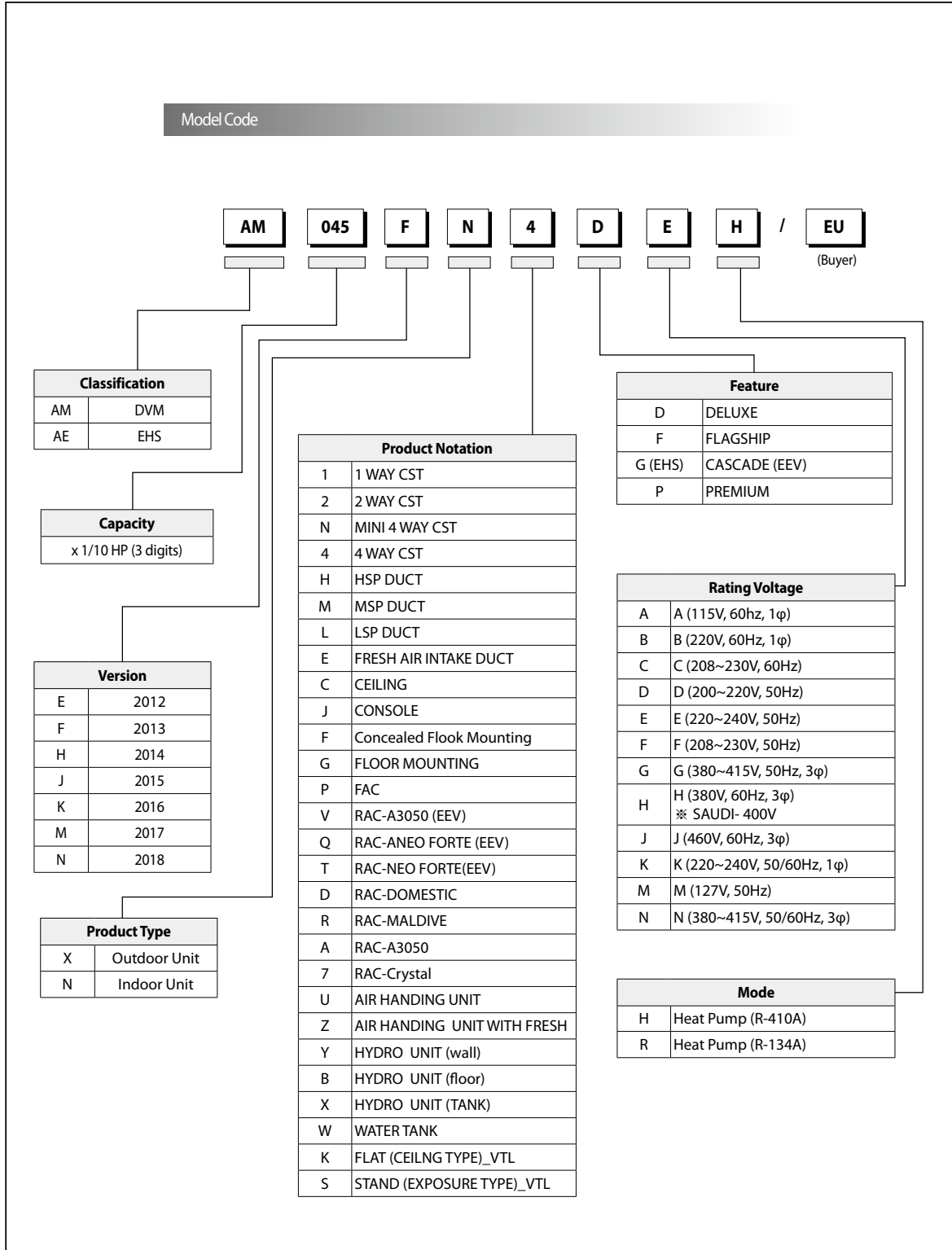

Index for Model Name(cont.)

7-1-2 Panel

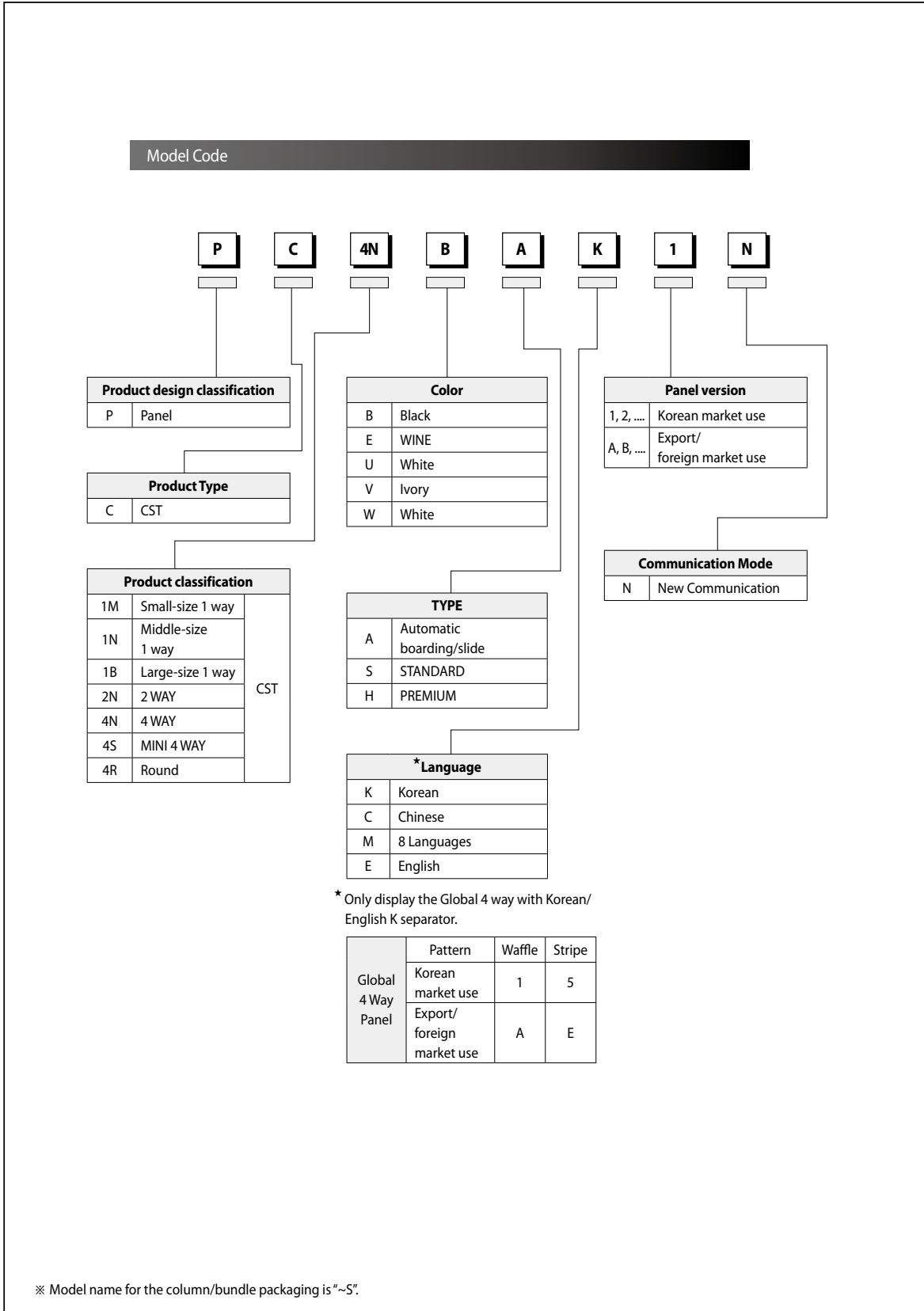

7-2 Pump-down Method

7-2-1 Precautions for Pump-down

1. If the pressure is kept low for a long time to completely replenish the refrigerant of the pipe during the pump-down, then the compressor may be damaged. Therefore, close the valve immediately if the pressure goes below 2kg/cm².g.
2. If the length of the pipe is too long or the outside temperature is too high, then it may not be able to pump down all of the refrigerant. In this case, use an empty refrigerant container which can be used for recharge to place some of the system refrigerant inside the container. The pump down can be easily carried out if only the remaining refrigerant is pumped down.



- Please use a rechargeable container for exclusive use when putting the refrigerant in the container. Accidents such as explosions can happen and result in damage if normal refrigerant containers are used after illegal modification.

7-2-2 For Single Installation of Outdoor Unit (Only One Outdoor Unit Installed)

1. Close the liquid pipe SVC valve.
2. Press the K2 Button on the PCB of the main outdoor unit. ("K7" mark displayed on the outdoor unit PCB LED.)
3. Observe for low pressure by using the K4 button's view mode once the compressor starts operating.
(If the first number of the LED is "4," then the following three digits represent the low pressure, expressed up to the first decimal point.)
Example: 41 22 → 4 means the value of the low pressure, and 122 means that the low pressure is 12.2kg/cm².g.
4. If the low pressure goes below around 2kg/cm².g, then immediately close the SVC valve for the gas and finish the pump-down operation.
(Finish the pump-down operation, press K2 button two more times, or reset the operation by pressing the K3 button once more.)

7-2-3 When Two or More Outdoor Units are Installed

1. Close the gas valves of each sub unit.
2. Press the K2 button of the outdoor unit PCB three times. At this time, K7 will be displayed on the PCB LED. After pressing the button, wait for about 20~30 minutes once the main unit compressor starts operating.
3. Close the liquid pipe valves of each sub unit.
4. Close the liquid pipe valves of the main unit, and observe for low pressure as in the case of a single outdoor unit.
5. Close the gas valve of the main unit if the pressure drops down, and then finish the pump-down operation mode.

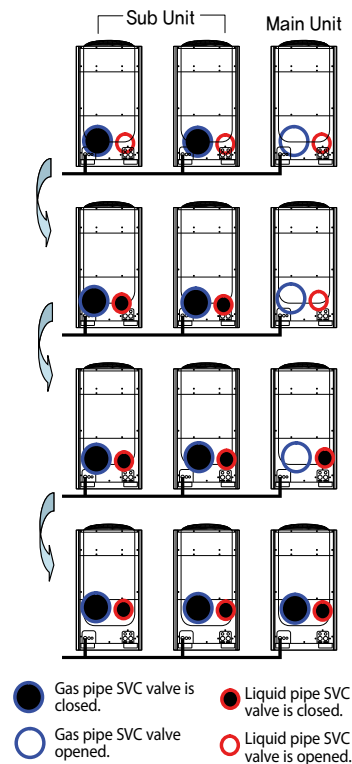

7-3 How to Put Refrigerant in Refrigerant Container

7-3-1 How to put refrigerant in container before pump-down

1. Prepare a rechargeable exclusive refrigerant container, a scale, and a Manifold gauge.
2. Check the amount of refrigerant remaining in the overall system at the time.
3. Connect the refrigerant container to the outdoor unit as shown in the following figure, and operate only about 50% of the total indoor units in air conditioning mode.
4. Check the high pressure from the Manifold gauge 10 minutes after the air conditioning begins operation.
Reduce the number of indoor units in operation if the high pressure goes above $30\text{kg/cm}^2\text{g}$. to lower the high pressure below $30\text{kg/cm}^2\text{g}$.
5. Check that the high pressure goes below $30\text{kg/cm}^2\text{g}$, and open the Manifold gauge connected to the liquid pipe, as well as the refrigerant container valve, so that the refrigerant flows from the liquid pipe to the refrigerant container.
6. Check the changes in the weight of the container using the scale. Once the desired amount of refrigerant is filled up inside the container, close the valves, and then remove the Manifold gauge.
7. The amount of refrigerant that can be contained inside the container is about 50% of the amount of refrigerant inside the overall system.
8. Please take extra caution by precisely determining the amount of the refrigerant that can be put in each container so that too much refrigerant is not contained in the container.
The weight must be measured by using a scale to avoid putting more refrigerant than the amount originally contained in the container.

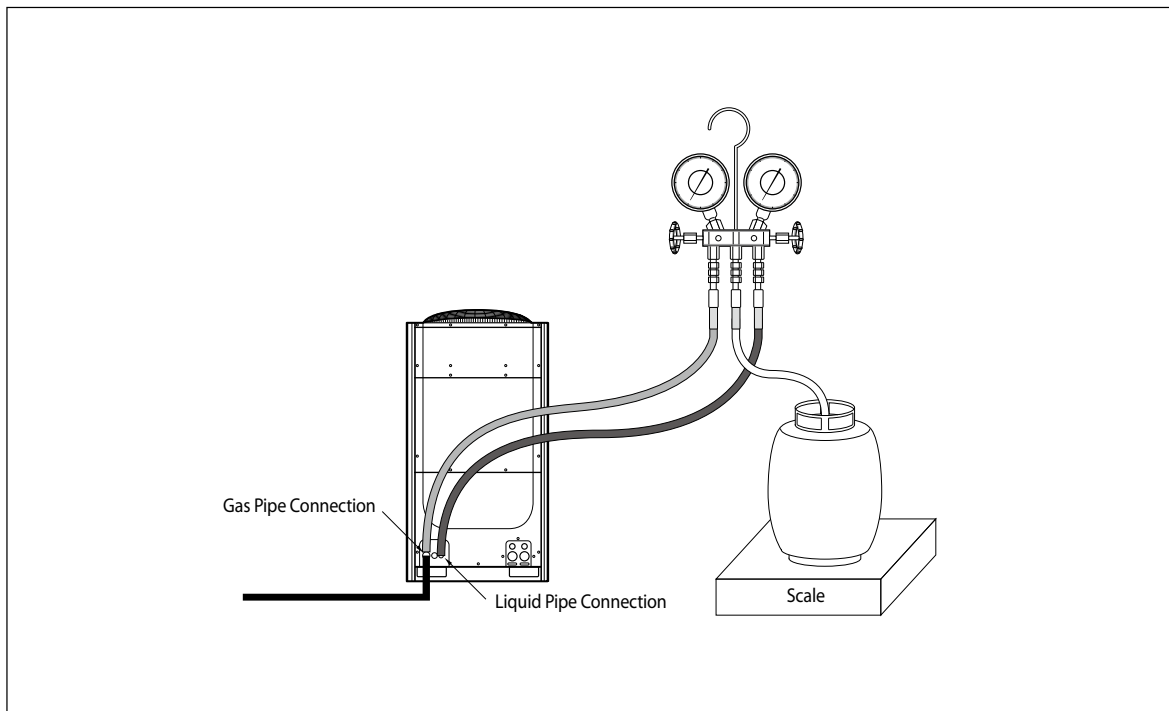

SAMSUNG

This Service Manual is a property of Samsung Electronics Co., Ltd.
Any unauthorized use of Manual can be punished under applicable
International and/or domestic law.

© Samsung Electronics Co., Ltd. FEBRUARY. 2018.
Printed in Korea.
Code No. AC-00211E_1