



Duct Type Series

BIG duct : AM***FNHDEH*

Air Conditioner installation manual

imagine the possibilities

Thank you for purchasing this Samsung product.

Contents

Safety Precautions	2
Accessories	5
Selecting the installation location	6
Indoor unit installation	9
Purging the unit	10
Connecting the refrigerant pipe.....	11
Cutting/Flaring the Pipes	12
Performing leak test & insulation.....	14
Drain pipe and Drain hose Installation	17
Wiring Work	21
Setting an indoor unit address and installation option.....	27
Setting temperature control of discharge air	38
Final Checks and User Tips	38
Providing information for user	38
Troubleshooting	39
Option table	41
Instruction for packing and unpacking the unit	42
Technical specifications.....	42

Safety Precautions

(Carefully follow the precautions listed below because they are essential to guarantee the safety of the equipment.)



WARNING

- Always disconnect the air conditioner from the power supply before servicing it or accessing its internal components.
- Verify that installation and testing operations are performed by qualified personnel.
- Verify that the air conditioner is not installed in an easily accessible area.

General information

- ▶ Carefully read the content of this manual before installing the air conditioner and store the manual in a safe place in order to be able to use it as reference after installation.
- ▶ For maximum safety, installers should always carefully read the following warnings.
- ▶ Store the operation and installation manual in a safe location and remember to hand it over to the new owner if the air conditioner is sold or transferred.
- ▶ This manual explains how to install an indoor unit with a split system with two SAMSUNG units. The use of other types of units with different control systems may damage the units and invalidate the warranty. The manufacturer shall not be responsible for damages arising from the use of non compliant units.
- ▶ The manufacturer shall not be responsible for damage originating from unauthorized changes or the improper connection of electric and hydraulic lines. Failure to comply with these instructions or to comply with the requirements set forth in the "Operating limits" table, included in the manual, shall immediately invalidate the warranty.
- ▶ The air conditioner should be used only for the applications for which it has been designed: the indoor unit is not suitable to be installed in areas used for laundry.
- ▶ Do not use the units if damaged. If problems occur, switch the unit off and disconnect it from the power supply.
- ▶ In order to prevent electric shocks, fires or injuries, always stop the unit, disable the protection switch and contact SAMSUNG's technical support if the unit produces smoke, if the power cable is hot or damaged or if the unit is very noisy.

- ▶ Always remember to inspect the unit, electric connections, refrigerant tubes and protections regularly. These operations should be performed by qualified personnel only.
- ▶ The unit contains moving parts, which should always be kept out of the reach of children.
- ▶ Do not attempt to repair, move, alter or reinstall the unit. If performed by unauthorized personnel, these operations may cause electric shocks or fires.
- ▶ Do not place containers with liquids or other objects on the unit.
- ▶ All the materials used for the manufacture and packaging of the air conditioner are recyclable.
- ▶ The packing material and exhaust batteries of the remote control(optional) must be disposed of in accordance with current laws.
- ▶ The air conditioner contains a refrigerant that has to be disposed of as special waste. At the end of its life cycle, the air conditioner must be disposed of in authorized centers or returned to the retailer so that it can be disposed of correctly and safely.

Installing the unit

IMPORTANT: When installing the unit, always remember to connect first the refrigerant tubes, then the electrical lines. Always disassemble the electric lines before the refrigerant tubes.

- ▶ Upon receipt, inspect the product to verify that it has not been damaged during transport. If the product appears damaged, DO NOT INSTALL it and immediately report the damage to the carrier or retailer (if the installer or the authorized technician has collected the material from the retailer.)
- ▶ After completing the installation, always carry out a functional test and provide the instructions on how to operate the air conditioner to the user.
- ▶ Do not use the air conditioner in environments with hazardous substances or close to equipment that release free flames to avoid the occurrence of fires, explosions or injuries.
- ▶ The air conditioner should be used only for the applications for which it has been designed: the indoor unit is not suitable to be installed in areas used for laundry.
- ▶ Our units must be installed in compliance with the spaces indicated in the installation manual to ensure either accessibility from both sides or ability to perform routine maintenance and repairs. The units' components must be accessible and that can be disassembled in conditions of complete safety either for people or things. For this reason, where it is not observed as indicated into the Installation Manual, the cost necessary to reach and repair the unit (in safety, as required by current regulations in force) with slings, trucks, scaffolding or any other means of elevation won't be considered in-warranty and charged to end user.

Power supply line, fuse or circuit breaker

- ▶ Always make sure that the power supply is compliant with current safety standards. Always install the air conditioner in compliance with current local safety standards.
- ▶ Always verify that a suitable grounding connection is available.
- ▶ Verify that the voltage and frequency of the power supply comply with the specifications and that the installed power is sufficient to ensure the operation of any other domestic appliance connected to the same electric lines.
- ▶ Always verify that the cut-off and protection switches are suitably dimensioned.
- ▶ Verify that the air conditioner is connected to the power supply in accordance with the instructions provided in the wiring diagram included in the manual.
- ▶ Always verify that electric connections (cable entry, section of leads, protections...) are compliant with the electric specifications and with the instructions provided in the wiring scheme. Always verify that all connections comply with the standards applicable to the installation of air conditioners.

Safety Precautions













CAUTION

- Make sure that you earth the cables.
 - Do not connect the earth wire to the gas pipe, water pipe, lighting rod or telephone wire. If earthing is not complete, electric shock or fire may occur.
- Install the circuit breaker.
 - If the circuit breaker is not installed, electric shock or fire may occur.
- Make sure that the condensed water dripping from the drain hose runs out properly and safely.
- Install the power cable and communication cable of the indoor and outdoor unit at least 1 m away from the electric appliance.
- Install the indoor unit away from lighting apparatus using the ballast.
 - If you use the wireless remote control, reception error may occur due to the ballast of the lighting apparatus.
- Do not install the air conditioner in following places.
 - Place where there is mineral oil or arsenic acid.
Resin parts flame and the accessories may drop or water may leak.
The capacity of the heat exchanger may reduce or the air conditioner may be out of order.
 - The place where corrosive gas such as sulfurous acid gas generates from the vent pipe or air outlet.
The copper pipe or connection pipe may corrode and refrigerant may leak.
 - The place where there is a machine that generates electromagnetic waves.
The air conditioner may not operate normally due to control system.
 - The place where there is a danger of existing combustible gas, carbon fiber or flammable dust.
The place where thinner or gasoline is handled. Gas may leak and it may cause fire.

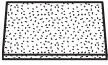
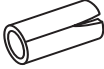
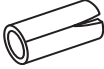
Accessories

The following accessories are supplied with the indoor unit.

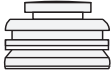
The type and quantity may differ depending on the specifications.

User's manual 	Installation manual 	Pattern sheet 	Insulation cover pipe in 
Insulation cover pipe out 	Insulation pipe(A) 	Insulation pipe(B) 	Cable tie 
Flexible hose 	Clamp hose 	Washer 	Rubber 
Sleeve 			

Selecting the installation location

Indoor Unit

- There must be no obstacles near the air inlet and outlet.
- Install the indoor unit on a ceiling that can support its weight.
- Maintain sufficient clearance around the indoor unit.
- Make sure that the water dripping from the drain hose runs away correctly and safely.
- The indoor unit must be installed in this way, that they are out of public access. (Not touchable by the users)
- After connecting a chamber, insulate the connection part between the indoor unit and the chamber with t10 or thicker insulation. Otherwise, there can be air leak or dew from the connection part.
- Rigid wall without vibration.
- Where it is not exposed to direct sunshine.
- Where the air filter can be removed and cleaned easily.

Space requirements for installation & service

- Construction Standard for Inspection Hole.
 - 1) In case, the ceiling is textile, Inspection hole dose not need.
 - 2) In case, the ceiling is plaster board, Inspection hole depends on Inside height of the ceiling.
 - a. Height is more than 0.5m : Only "B" [Inspection for PBA] is applied.
 - b. Height is less than 0.5m : Both "A" & "B" are applied.
 - c. "A" & "B" are inspection holes.

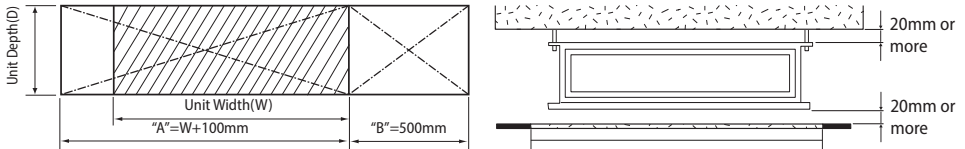

- You must have 20mm or more space between the ceiling and the bottom of indoor unit. Otherwise, the noise from the vibration of indoor unit may bother the user. When the ceiling is under construction, the hole for check-up must be made to take service, clean and repair the unit.
- It is possible to install the unit at an height of between 2.2~2.5m from the ground, if the unit has a duct with a well defined length (300mm or more), to avoid fan motor blower contact.

Insulation Guide

(Unit : mm)

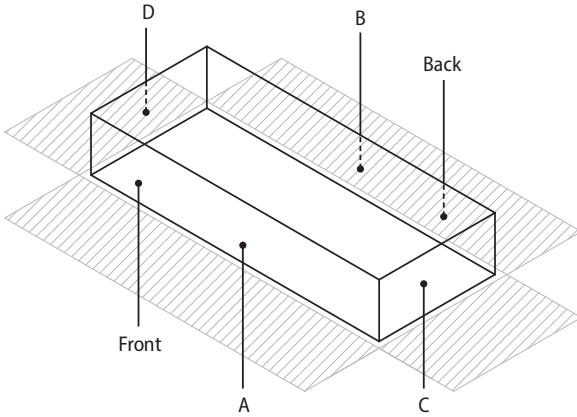

Thickness: more than 10mm

Indoor unit	A	B	C	D	Front/Back
20.0~28.0kW (1240x470x1040)	1240x1040	1240x1040	470x1040	470x1040	Insulate the front and back side in proper size at the same time when insulating the suction duct and discharge duct.

- Insulate the end of the pipe and some curved area by using separate insulator.
- Insulate the discharge and suction part at the same time when you insulate connection duct.

Selecting the installation location

Drawing of the indoor unit

(Unit : mm)

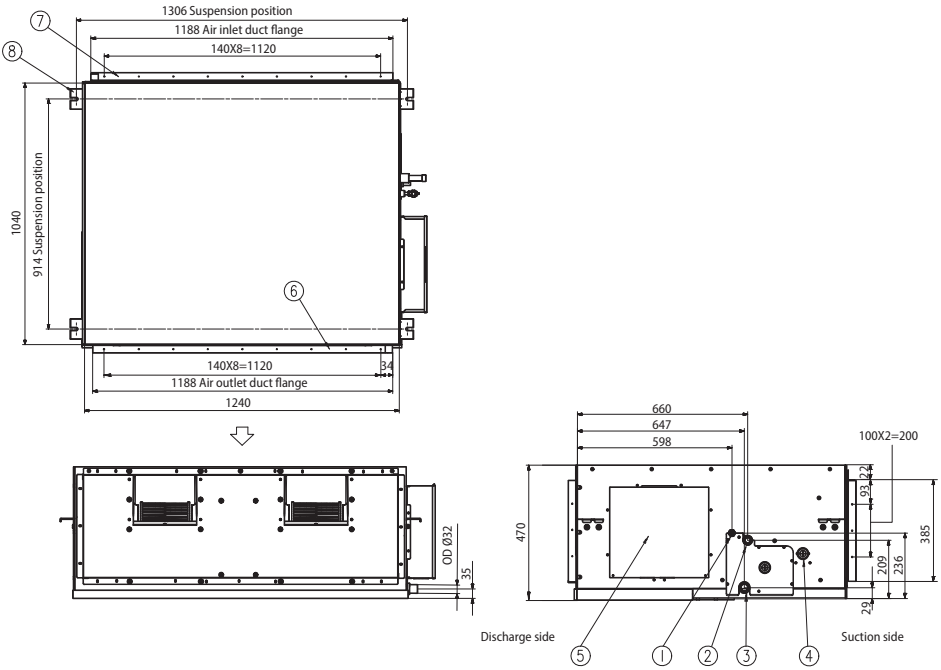

No.	Name	Description
1	Liquid pipe connection	ø9.52
2	Gas pipe connection	**220** : ø19.05 **280** : ø22.22
3	Drain pipe connection	VP25 (OD ø32, ID ø25)
4	Drain pipe connection (Option drain pump)	VP25 (OD ø32, ID ø25)
5	Power supply/Communication connection	
6	Air discharge grille flange	
7	Air suction flange	
8	Hook	Φ9.52 or M10

Indoor unit installation

It is recommended to install the Y-joint before installing the indoor unit.

1. Place the pattern sheet on the ceiling at the spot where you want to install the indoor unit.



- Since the diagram is made of paper, it may shrink or stretch slightly due to temperature or humidity. For this reason, before drilling the holes maintain the correct dimensions between the markings.

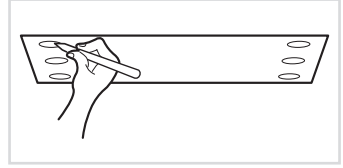

2. Insert bolt anchors, use existing ceiling supports or construct a suitable support as shown in figure.

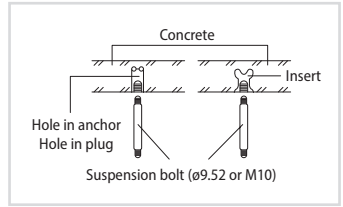

3. Install the suspension bolts depending on the ceiling type.



- Ensure that the ceiling is strong enough to support the weight of the indoor unit. Before hanging the unit, test the strength of each attached suspension bolt.
- If the length of suspension bolt is more than 1.5m, it is required to prevent vibration.
- If this is not possible, create an opening on the false ceiling in order to be able to use it to perform the required operations on the indoor unit.

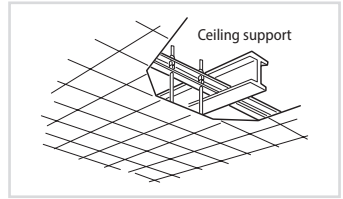

4. Screw eight nuts to the suspension bolts making space for hanging the indoor unit.



- You must install the suspension bolts more than four when installing the indoor unit.

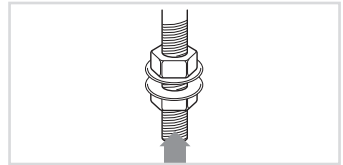

5. Hang the indoor unit to the suspension bolts between two nuts.



- Piping must be laid and connected inside the ceiling when suspending the unit. If the ceiling is already constructed, lay the piping into position for connection to the unit before placing the unit inside the ceiling.

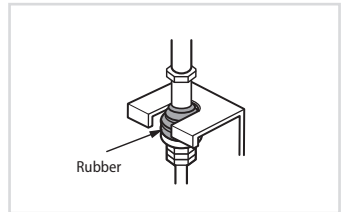

6. Screw the nuts to suspend the unit.

7. Adjust level of the unit by using measurement plate for all 4 sides.



- For proper drainage of condensate, give a 'A' slant to the left or right side of the unit which will be connected with the drain hose, as shown in the figure. Make a tilt when you wish to install the drain pump, too.

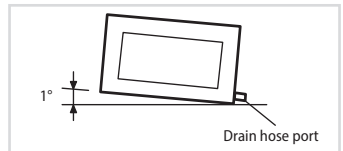

Purging the unit

On delivery, the indoor unit is loaded with inert gas.

All this gas must therefore be purged before connecting the assembly piping. To purge the inert gas, proceed as follows.

Unscrew the pinch pipe at the end of each refrigerant pipe.

Result: All inert gas escapes from the indoor unit.



- To prevent dirt or foreign objects from getting into the pipes during installation, do NOT remove the pinch pipe completely until you are ready to connect the piping.

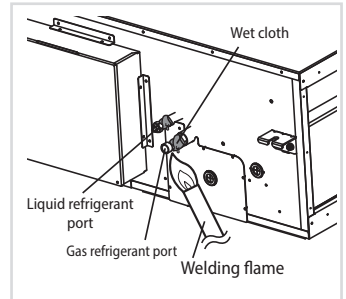

Connecting the refrigerant pipe

There are two refrigerant pipes of differing diameters:

- A smaller one for the liquid refrigerant
- A larger one for the gas refrigerant
- The inside of copper pipe must be clean & has no dust.

The connection procedure for the refrigerant pipes varies according to the exit position of the pipes from the indoor unit, as seen when facing the indoor in the "A" side.

- Liquid refrigerant port
- Gas refrigerant port
- Drain hose port

1. Remove the pinch pipe on the pipes and connect the assembly pipes to each pipe, tightening the nuts, first manually and then with a torque wrench, a spanner applying the following torque.

Outer Diameter (mm)	Torque	
	kgf·cm	N·m
6.35	140~180	14~18
9.52	350~430	34~42
12.70	500~620	49~61
15.88	690~830	68~82



- Must apply refrigerant oil on the flaring area to prevent a leak.

2. Be sure that there must be no crack or kink on the bended area.

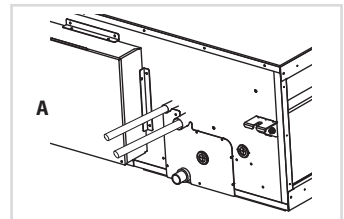
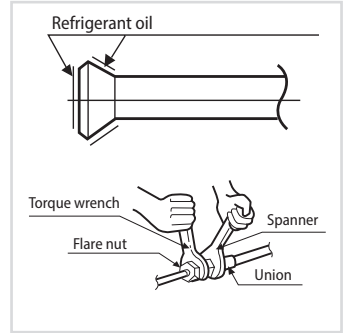

The designs and shape are subject to change according to the model.

Cutting/Flaring the Pipes

1. Make sure that you prepared the required tools. (pipe cutter, reamer, flaring tool and pipe holder)
2. If you want to shorten the pipe, cut it using a pipe cutter ensuring that the cut edge remains at 90° with the side of the pipe. There are some examples of correctly and incorrectly cut edges below.

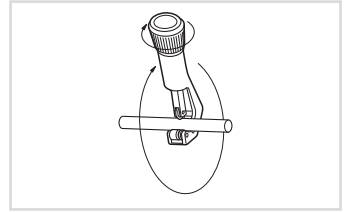
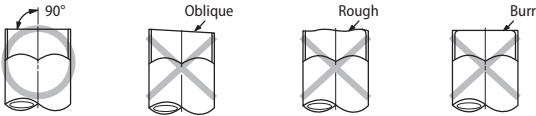

3. To prevent a gas leak, remove all burrs at the cut edge of the pipe using a reamer.
4. Carry out flaring work using flaring tool as shown below.

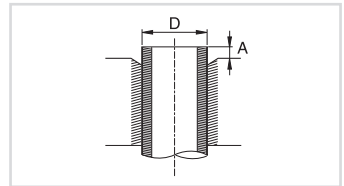
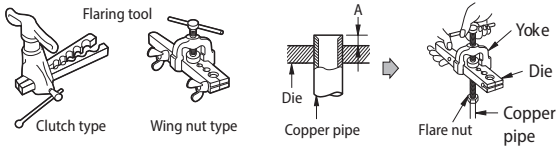

Outer diameter [D (mm)]	Depth [A (mm)]		
	Flare tool for R-410A clutch type	Conventional flare tool	
		Clutch type	Wing nut type
6.35	0~0.5	1.0~1.5	1.5~2.0
9.52	0~0.5	1.0~1.5	1.5~2.0
12.70	0~0.5	1.0~1.5	1.5~2.0
15.88	0~0.5	1.0~1.5	1.5~2.0

5. Check if you flared the pipe correctly. There are some examples of incorrectly flared pipes below.



Correct



Inclined



Damaged Surface

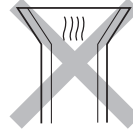

Cracked



Uneven Thickness

6. Align the pipes and tighten the flare nuts first manually and then with a torque wrench, applying the following torque.

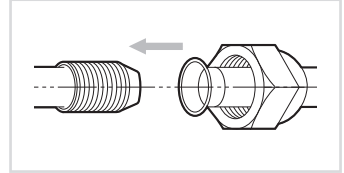

Outer diameter (D, mm)	Connection Torque(N·m)	Flare dimension (A, mm)	Flare shape
ø6.35	14~18	8.7~9.1	
ø9.52	34~42	12.8~13.2	
ø12.70	49~61	16.2~16.6	
ø15.88	68~82	19.3~19.7	
ø19.05	100~120	23.6~24.0	

* 1N·m=10kgf·cm



• In case of needing brazing, you must work with Nitrogen gas blowing.

Performing leak test & insulation

Leak test

LEAK TEST WITH NITROGEN (before opening valves)

In order to detect basic refrigerant leaks, before recreating the vacuum and recirculating the R410A, it's responsible of installer to pressurize the whole system with nitrogen (using a pressure regulator) at a pressure above 4.1MPa (gauge).

LEAK TEST WITH R410A (after opening valves)

Before opening valves, discharge all the nitrogen into the system and create vacuum. After opening valves check leaks using a leak detector for refrigerant R410A.

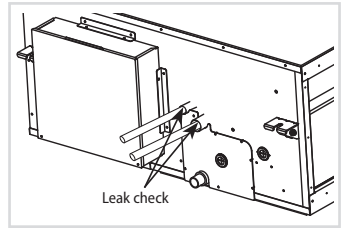

- Discharge all the nitrogen to create a vacuum and charge the system.

Insulation

Once you have checked that there are no leaks in the system, you can insulate the piping and hose.

1. To avoid condensation problems, place **T13.0 or thicker Acrylonitrile Butadien Rubber** separately around each refrigerant pipe.



- Always make the seam of pipes face upwards.

2. Wind insulating tape around the pipes and drain hose avoiding to compress the insulation too much.
3. Finish wrapping insulating tape around the rest of the pipes leading to the outdoor unit.
4. The pipes and electrical cables connecting the indoor unit with the outdoor unit must be fixed to the wall with suitable ducts.

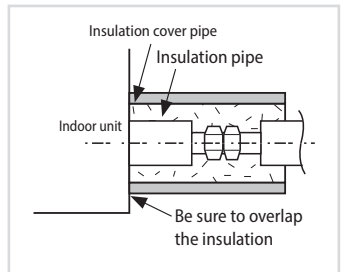
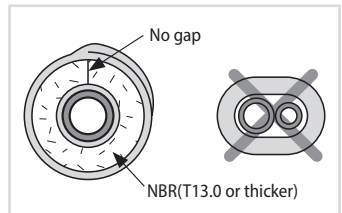

- All refrigerant connection must be accessible, in order to permit either unit maintenance or removing it completely.



- Must fit tightly against body without any gap.

5. Select the insulation of the refrigerant pipe.
- Insulate the gas side and liquid side pipe referring to the thickness according to the pipe size.
 - Indoor temperature of 30°C and humidity of 85% is the standard condition.
If install in a high humidity condition, use one grade thicker insulator by referring to the table below.
 - If installing in an unfavorable conditions, use thicker one.
 - Insulator's heat-resistance temperature should be more than 120°C.

Pipe	Pipe size	Insulation Type (Heating/Cooling)		Remarks
		Standard [30°C, 85%]	High humidity [30°C, over 85%]	
		EPDM, NBR		
Liquid pipe	Ø6.35 ~ Ø9.52	9t	9t	Internal temperature is higher than 120°C
	Ø12.7 ~ Ø50.80	13t	13t	
Gas pipe	Ø6.35	13t	19t	
	Ø9.52~Ø25.40	19t	25t	
	Ø28.58~Ø44.45		32t	
	Ø50.80	25t	38t	

- When installing insulation in places and conditions below, use the same insulation that is used for high humidity conditions.
 - <Geological condition>
 - High humidity places such as shoreline, hot spring, near lake or river, and ridge (when the part of the building is covered by earth and sand.)
 - <Operation purpose condition>
 - Restaurant ceiling, sauna, swimming pool etc.
 - <Building construction condition>
 - The ceiling frequently exposed to moisture and cooling is not covered.
e.g. The pipe installed at a corridor of a dormitory and studio or near an exit that opens and closes frequently.
 - The place where the pipe is installed is highly humid due to the lack of ventilation system.

Performing leak test & insulation

Refrigerant pipe before EEV kit and MCU or without EEV kit and MCU

- You can contact the gas side and liquid side pipes but the pipes should not be pressed.
- When contacting the gas side and gas side pipe, use 1 grade thicker insulator.

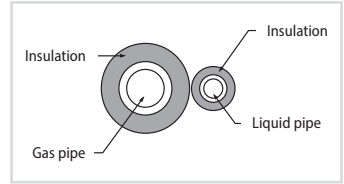

Refrigerant pipe after EEV kit and MCU

- Install the gas side and liquid side pipes, leave 10mm of space.
- When contacting the gas side and liquid side pipe, use 1 grade thicker insulator.

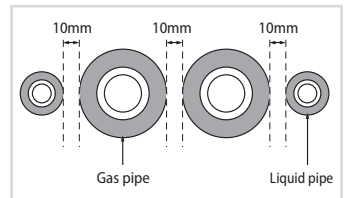

CAUTION

- Install the insulation not to get wider and use the adhesives on the connection part of it to prevent moisture from entering.
- Wind the refrigerant pipe with insulation tape if it is exposed to outside sunlight.
- Install the refrigerant pipe respecting that the insulation does not get thinner on the bent part or hanger of pipe.
- Add the additional insulation if the insulation plate gets thinner.

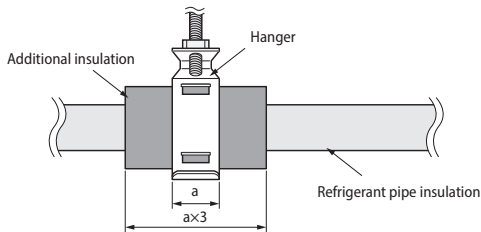

Drain pipe and Drain hose Installation

Care must be taken when installing the drain hose for the indoor unit to ensure that any condensate water is correctly drained outside. The drain hose can be installed to the right or left side of the base pan.

1. Unscrew the 4 tapped screws to remove the cover of the drain hose connection port.

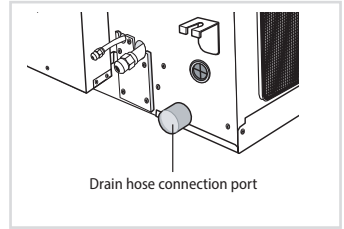

2. Insert the flexible hose to the drain hose port.

- NOTE**
- Fix the flexible hose to the indoor unit with the supplied cable clamp securely.
(Use the screwdriver to fix the flexible hose securely.)

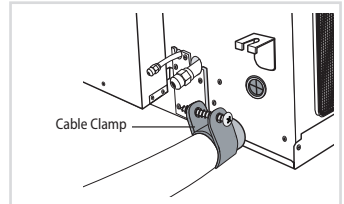

3. Install the drain hose so that its length can be as short as possible.

Internal diameter of the drain hose should be the same or slightly bigger than the external diameter of the drain hose port.

- Inner diameter of the drain hose



- NOTE**
- Give a slightly slant to the drain hose for proper drainage of condensate.
 - Fix the flexible hose to the PVC with the supplied cable tie securely.

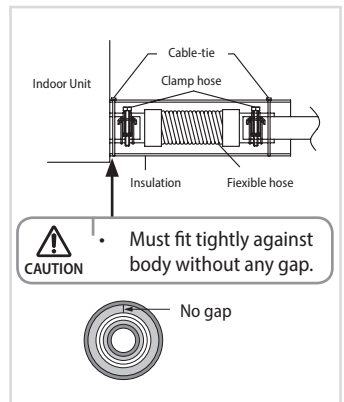

4. Wrap the drain hose with the insulation drain as shown in figure and secure it.

Drain pipe and Drain hose Installation

Drainpipe Connection

Without the drain pump

1. Install horizontal drainpipe with a slope of 1/100 or more and fix it by hanger space of 1.0~1.5m.
2. Install U-trap at the end of the drainpipe to prevent a nasty smell to reach the indoor unit.
3. Do not install the drainpipe to upward position. It may cause water flow back to the unit.

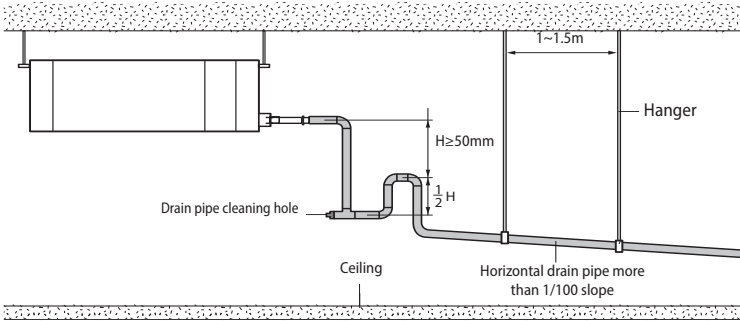

With the drain pump

1. The drain pipe should be installed within 300mm to 550mm from the flexible hose and then lift down 20mm or more.
2. Install horizontal drainpipe with a slope of 1/100 or more and fix it by hanger space of 1.0~1.5m.
3. Install the air vent in the horizontal drainpipe to prevent water flow back to the indoor unit.



You may not need to install it if there were proper slope in the horizontal drainpipe.

4. The flexible hose should not be installed upward position, it may cause water flow back to the indoor unit.

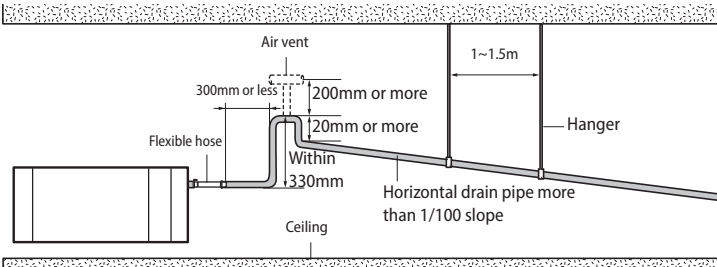

Centralized Drainage

Without the drain pump

1. Install horizontal drainpipe with a slope of 1/100 or more and fix it by hanger space of 1.0~1.5m.
2. Install U-trap at the end of the drainpipe to prevent a nasty smell to reach the indoor unit.

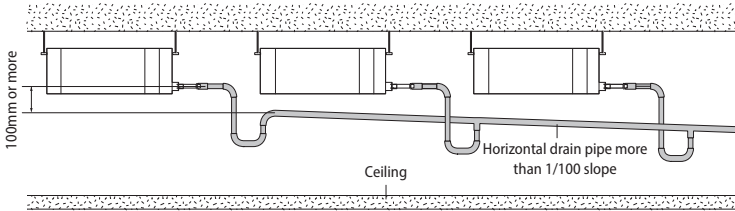

With the drain pump

1. Install main air vent at the front of the farthest indoor unit from the main drain when installed indoor units are more than 3.
2. You may need to install individual air vent to prevent water flow back at the top of each indoor unit drainpipe.

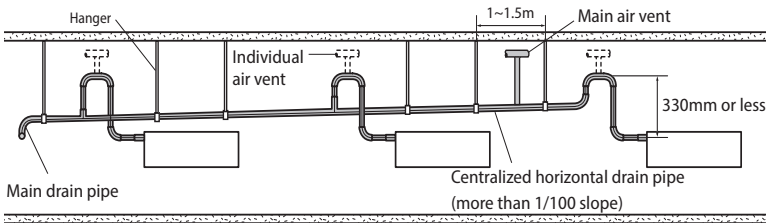

Drain pipe and Drain hose Installation

Testing the drainage

Prepare a little water about 2 liters.

1. Pour water into the drain pan in the indoor unit as shown in figure.
2. Confirm that the water flows out through the drain hose.
3. When the drain pump is installed, operate the unit as cooling mode and check a drain pump pumping.

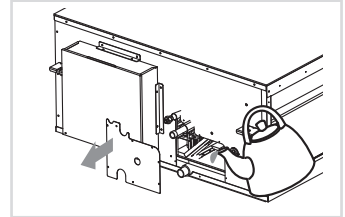
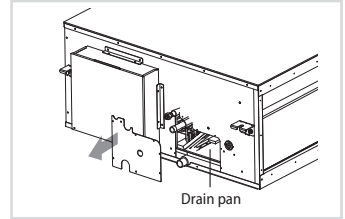

The designs and shape are subject to change according to the model.

4. Check drain water drops at the end of the drain pipe.
5. Make sure there is no water leak at the drainage.
6. Reassemble the cover of water supply intake.

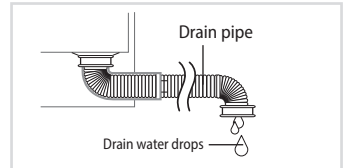

Wiring Work

Power and communication cable connection

1. Before wiring work, you must turn off all power source.
2. Indoor unit power should be supplied through the breaker (ELCB or MCCB+ELB) separated by the outdoor power.
 ELCB: Earth Leakage Circuit Breaker
 MCCB: Molded Case Circuit Breaker
 ELB: Earth Leakage Breaker
3. The power cable should be used only copper wires.
4. Connect the power cable{1(L), 2(N)} among the units within maximum length and communication cable(F1, F2) each.
5. Connect F3, F4(for communication) when installing the wired remote control.

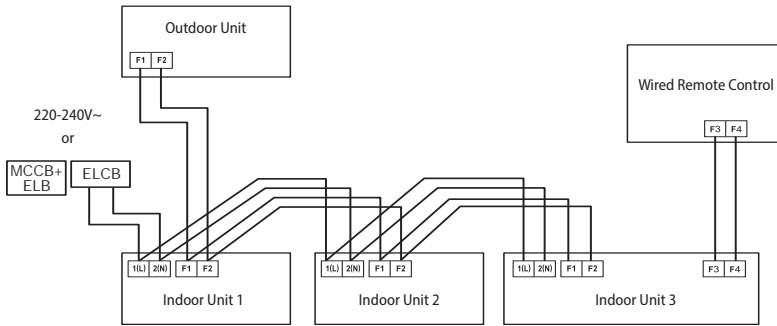

* ELCB : Essential Installation

Connecting power for optional product

- When installing optional product, make sure to follow below current capacity.
- * Optional product is not supplied by manufacturer.

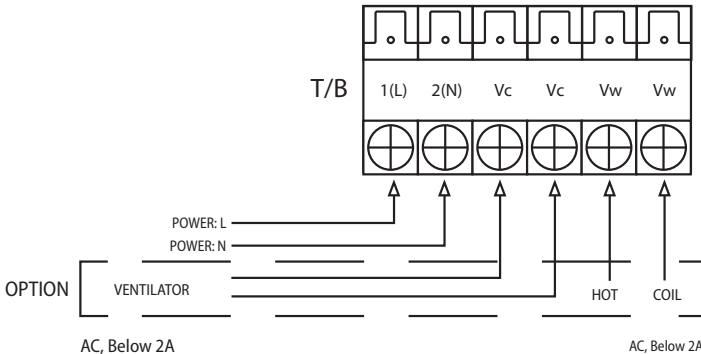

Wiring Work

Selecting compressed ring terminal

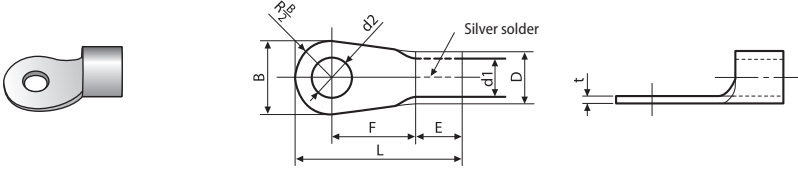

Nominal dimensions for cable (mm ²)	Nominal dimensions for screw (mm)	B		D		d1		E	F	L	d2		t
		Standard dimension (mm)	Allowance (mm)	Standard dimension (mm)	Allowance (mm)	Standard dimension (mm)	Allowance (mm)				Standard dimension (mm)	Allowance (mm)	
1.5	4	6.6	±0.2	3.4	+0.3 -0.2	1.7	±0.2	4.1	6	16	4.3	+0.2 0	0.7
	4	8											
2.5	4	6.6	±0.2	4.2	+0.3 -0.2	2.3	±0.2	6	6	17.5	4.3	+0.2 0	0.8
	4	8.5											
4	4	9.5	±0.2	5.6	+0.3 -0.2	3.4	±0.2	6	5	20	4.3	+0.2 0	0.9

Specification of electronic wire

Power supply	MCCB	ELB or ELCB	Power cable	Earth cable	Communication cable
Max : 242V Min : 198V	XA	XA, 30mmA 0.1 s	2.5mm ²	2.5mm ²	0.75~1.5mm ²

- ※ Run transmission wiring between the indoor and outdoor units through a conduit to protect against external forces, and feed the conduit through the wall together with refrigerant piping.
- ※ Rating current

Unit	Model	Rating current
AM***FNHDEH*	**220**	3.8A
	280	5.9A

- Decide the capacity of ELCB(or MCCB+ELB) by below formula.

$$\text{The capacity of ELCB(or MCCB+ELB) X [A]} = 1.25 \times 1.1 \times \sum A_i$$

- * X : The capacity of ELCB(or MCCB+ELB).
- * $\sum A_i$: Sum of Rating currents of each indoor unit.
- * Refer to each installation manual about the rating current of indoor unit.

- Decide the power cable specification and maximum length within 10% power drop among indoor units.

$$\sum_{k=1}^n \left(\frac{\text{Coef} \times 35.6 \times L_k \times i_k}{1000 \times A_k} \right) < 10\% \text{ of input voltage [V]}$$

Coef: 1.55

* L_k : Distance among each indoor unit [m]

A_k : Power cable specification [mm²]

i_k : Running current of each unit [A]

Example of Installation

- Total power cable length $L = 100$ (m), Running current of each units 1 [A]
- Total 10 indoor units were installed

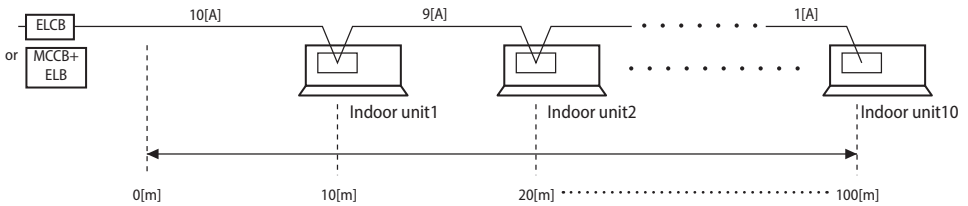

- Apply following equation.

$$\sum_{k=1}^n \left(\frac{\text{Coef} \times 35.6 \times L_k \times i_k}{1000 \times A_k} \right) < 10\% \text{ of input voltage [V]}$$

* Calculation

- Installing with 1 sort wire.

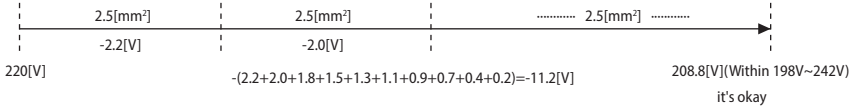

- Installing with 2 different sort wire.

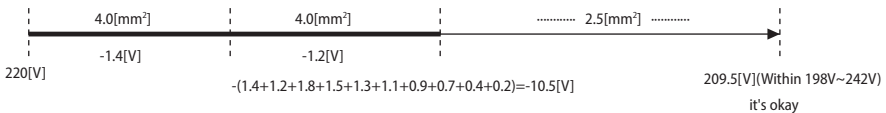

Wiring Work







CAUTION

- Select the power cable in accordance with relevant local and national regulations.
- Wire size must comply with local and national code.
- Power Supply cords of parts of appliances for outdoor use shall not be lighter than polychloroprene sheathed flexible cord. (Code designation IEC:60245 IEC 57 / CENELEC: H05RN-F or IEC:60245 IEC 66 / CENELEC: H07RN-F)
- You should connect the power cable into the power cable terminal and fasten it with a clamp.
- The unbalanced power must be maintained within 10% of supply rating among whole indoor units.
- If the power is unbalanced greatly, it may shorten the life of the condenser. If the unbalanced power is exceeded over 10% of supply rating, the indoor unit is protected, stopped and the error mode indicates.
- To protect the product from water and possible shock, you should keep the power cable and the connection cord of the indoor and outdoor units in the iron pipe.
- Connect the power cable to the auxiliary circuit breaker.
An all pole disconnection from the power supply must be incorporated in the fixed wiring($\geq 3\text{mm}$).
- You must keep the cable in a protection tube.
- Keep distances of 50mm or more between power cable and communication cable.
- Maximum length of power cables are decided within 10% of power drop. If it exceeds, you must consider another power supplying method.
- The circuit breaker(ELCB or MCCB+ELB) should be considered more capacity if many indoor units are connected from one breaker.
- Use round pressure terminal for connections to the power terminal block.
- For wiring, use the designated power cable and connect it firmly, then secure to prevent outside pressure being exerted on the terminal board.
- Use an appropriate screwdriver for tightening the terminal screws. A screwdriver with a small head will strip the head and make proper tightening impossible.
- Over-tightening the terminal screws may break them.
- See the table below for tightening torque for the terminal screws.

	Tightening torque	
	N·m	kgf·cm
M3.5	0.8~1.2	8.0~12.0
M4	1.2~1.8	12.0~18.0

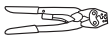
How to connect your extended power cables

1. Prepare a compressor and the following tools.

Tools	Crimping pliers	Connection sleeve (mm)	Insulation tape	Contraction tube (mm)
Spec	MH-14	20xØ6.5(HxOD)	Width 19mm	70xØ8.0(LxOD)
Shape				

2. As shown in the figure, peel off the shields from the rubber or wire of the power cable.

- Peel off 20 mm of the wire shields of the tube installed already.

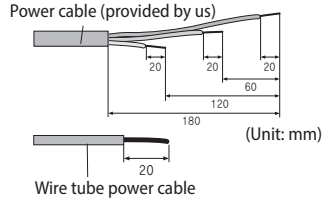

CAUTION

- After peeling off the tube wire, you must insert a contraction tube.
- For information about the power cable specifications for indoor and outdoor units, refer to the installation manual.

3. Insert both sides of core wire of the power cable into the connection sleeve.

► **Method 1**

- Push the core wire into the sleeve from both sides.

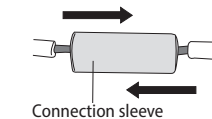

► **Method 2**

- Twist the wire cores together and push it into the sleeve.

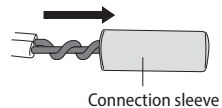

4. Using a compressor, compress the two points and flip it over and compress another two points in the same location.

- The compression dimension should be 8.0.
- After compressing it, pull both sides of the wire to make sure it is firmly pressed.

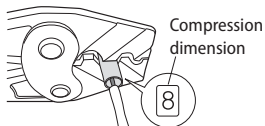

► **Method 1**

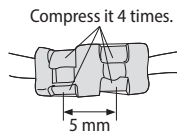

► **Method 2**

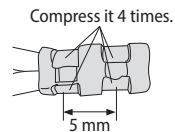

Wiring Work

5. Wrap it with the insulation tape twice or more and position your contraction tube in the middle of the insulation tape.

A total of three or more layers of insulation is required.

► **Method 1**

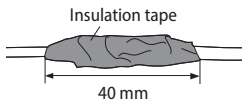

► **Method 2**

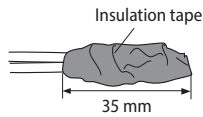

6. Apply heat to the contraction tube to contract it.

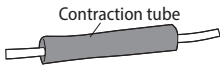

7. After tube contraction work is completed, wrap it with the insulation tape to finish.



- Make sure that the connection parts are not exposed to outside.
- Be sure to use insulation tape and a contraction tube made of approved reinforced insulating materials that have the same level of withstand voltage with the power cable. (Comply with the local regulations on extensions.)

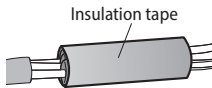

- In case of extending the electric wire, please DO NOT use a round-shaped Pressing socket.
 - Incomplete wire connections can cause electric shock or a fire.

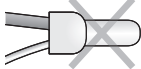

Setting an indoor unit address and installation option

Set the indoor unit address and installation option with remote controller option.

Set the each option separately since you cannot set the ADDRESS setting and indoor unit installation setting option at the same time. You need to set twice when setting indoor unit address and installation option.

The procedure of option setting

MR-DC00, MR-DH00

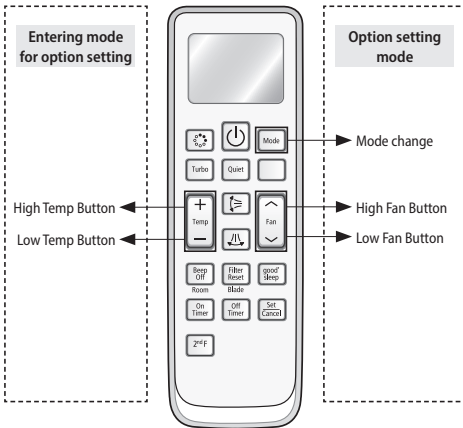

MR-EC00, MR-EH00

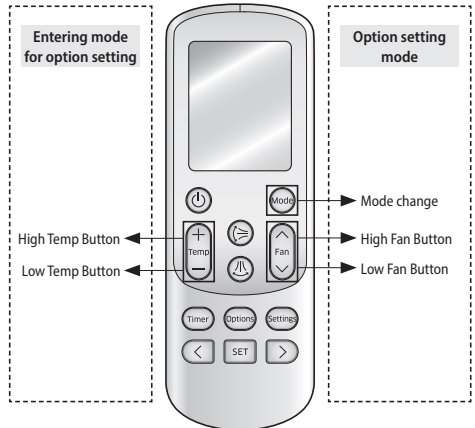

* The display of the remote controller may be different depending on the model.

Step 1. Entering mode to set option



1. Remove batteries from the remote controller.
2. Insert batteries and enter the option setting mode while pressing High Temp button and Low Temp button.
3.  Check if you have entered the option setting status.

Step 2. The procedure of option setting

























After entering the option setting status, select the option as listed below.











- CAUTION**  Option setting is available from SEG1 to SEG 24
- SEG1, SEG7, SEG13, SEG19 are not set as page option.
 - Set the SEG2~SEG6, SEG8~SEG12 as ON status and SEG14~18, SEG20~24 as OFF status.

SEG1	SEG2	SEG3	SEG4	SEG5	SEG6	SEG7	SEG8	SEG9	SEG10	SEG11	SEG12
0	X	X	X	X	X	1	X	X	X	X	X
SEG13	SEG14	SEG15	SEG16	SEG17	SEG18	SEG19	SEG20	SEG21	SEG22	SEG23	SEG24
2	X	X	X	X	X	3	X	X	X	X	X

On(SEG1~12)	Off(SEG13~24)
	

Setting an indoor unit address and installation option

Option setting	Status
<p>1. Setting SEG2, SEG3 option Press Low Fan button(V) to enter SEG2 value. Press High Fan button(Λ) to enter SEG3 value. Each time you press the button, → → ... → will be selected in rotation.</p>	<div style="display: flex; justify-content: space-around;"> <div style="text-align: center;">  SEG2 </div> <div style="text-align: center;">  SEG3 </div> </div>
<p>2. Setting Cool mode  Press Mode button to be changed to Cool mode in the ON status.</p>	<div style="text-align: center;">  </div>
<p>3. Setting SEG4, SEG5 option Press Low Fan button(V) to enter SEG4 value. Press High Fan button(Λ) to enter SEG5 value. Each time you press the button, → → ... → will be selected in rotation.</p>	<div style="display: flex; justify-content: space-around;"> <div style="text-align: center;">  SEG4 </div> <div style="text-align: center;">  SEG5 </div> </div>
<p>4. Setting Dry mode  Press Mode button to be changed to DRY mode in the ON status.</p>	<div style="text-align: center;">  </div>
<p>5. Setting SEG6, SEG8 option Press Low Fan button(V) to enter SEG6 value. Press High Fan button(Λ) to enter SEG8 value. Each time you press the button, → → ... → will be selected in rotation.</p>	<div style="display: flex; justify-content: space-around;"> <div style="text-align: center;">  SEG6 </div> <div style="text-align: center;">  SEG8 </div> </div>
<p>6. Setting Fan mode  Press Mode button to be changed to FAN mode in the ON status.</p>	<div style="text-align: center;">  </div>
<p>7. Setting SEG9, SEG10 option Press Low Fan button(V) to enter SEG9 value. Press High Fan button(Λ) to enter SEG10 value. Each time you press the button, → → ... → will be selected in rotation.</p>	<div style="display: flex; justify-content: space-around;"> <div style="text-align: center;">  SEG9 </div> <div style="text-align: center;">  SEG10 </div> </div>
<p>8. Setting Heat mode  Press Mode button to be changed to HEAT mode in the ON status.</p>	<div style="text-align: center;">  </div>
<p>9. Setting SEG11, SEG12 option Press Low Fan button(V) to enter SEG11 value. Press High Fan button(Λ) to enter SEG12 value. Each time you press the button, → → ... → will be selected in rotation.</p>	<div style="display: flex; justify-content: space-around;"> <div style="text-align: center;">  SEG11 </div> <div style="text-align: center;">  SEG12 </div> </div>
<p>10. Setting Auto mode  Press Mode button to be changed to AUTO mode in the OFF status.</p>	<div style="text-align: center;">  </div>
<p>11. Setting SEG14, SEG15 option Press Low Fan button(V) to enter SEG14 value. Press High Fan button(Λ) to enter SEG15 value. Each time you press the button, → → ... → will be selected in rotation.</p>	<div style="display: flex; justify-content: space-around;"> <div style="text-align: center;">  SEG14 </div> <div style="text-align: center;">  SEG15 </div> </div>
<p>12. Setting Cool mode  Press Mode button to be change to Cool mode in the OFF status.</p>	<div style="text-align: center;">  </div>

Option setting	Status
<p>13. Setting SEG16, SEG17 option Press Low Fan button(V) to enter SEG16 value. Press High Fan button(Λ) to enter SEG17 value. Each time you press the button, 0 → 1 → ... 8 → 9 will be selected in rotation.</p>	 <p>SEG16 SEG17</p>
<p>14. Setting Dry mode  Press Mode button to be change to Dry mode in the OFF status.</p>	
<p>15. Setting SEG18, SEG20 option Press Low Fan button(V) to enter SEG18 value. Press High Fan button(Λ) to enter SEG20 value. Each time you press the button, 0 → 1 → ... 8 → 9 will be selected in rotation.</p>	 <p>SEG18 SEG20</p>
<p>16. Setting Fan mode  Press Mode button to be change to Fan mode in the OFF status.</p>	
<p>17. Setting SEG21, SEG22 option Press Low Fan button(V) to enter SEG21 value. Press High Fan button(Λ) to enter SEG22 value. Each time you press the button, 0 → 1 → ... 8 → 9 will be selected in rotation.</p>	 <p>SEG21 SEG22</p>
<p>18. Setting Heat mode  Press Mode button to be change to HEAT mode in the OFF status.</p>	
<p>19. Setting SEG23, SEG24 mode Press Low Fan button(V) to enter SEG23 value. Press High Fan button(Λ) to enter SEG24 value. Each time you press the button, 0 → 1 → ... 8 → 9 will be selected in rotation.</p>	 <p>SEG23 SEG24</p>

Step 3. Check the option you have set

After setting option, press  button to check whether the option code you input is correct or not.

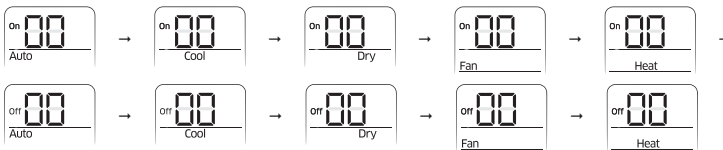

Step 4. Input option

Press operation button  with the direction of remote control for set.
 For the correct option setting, you must input the option twice.

Step 5. Check operation

1. Reset the indoor unit by pressing the RESET button of indoor unit or outdoor unit.
2. Take the batteries out of the remote controller and insert them again and then press the operation button.

Setting an indoor unit address and installation option

Setting an indoor unit address (MAIN/RMC)

1. Check whether power is supplied or not.
 - When the indoor unit is not plugged in, there should be additional power supply in the indoor unit.
2. The panel(display) should be connected to an indoor unit to receive option.
3. Before installing the indoor unit, assign an address to the indoor unit according to the air conditioning system plan.
4. Assign an indoor unit address by wireless remote controller.
 - The initial setting status of indoor unit ADDRESS(MAIN/RMC) is "0A0000-100000-200000-300000".

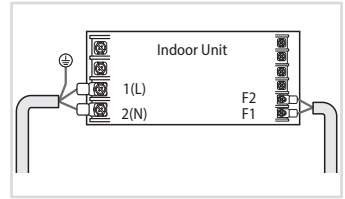

Option No. : 0AXXXX-1XXXXX-2XXXXX-3XXXXX

Option	SEG1		SEG2		SEG3		SEG4		SEG5		SEG6	
Explanation	PAGE		MODE		Setting Main address		100-digit of indoor unit address		10-digit of indoor unit		The unit digit of an indoor unit	
Remote Controller Display												
Indication and Details	Indication	Details	Indication	Details	Indication	Details	Indication	Details	Indication	Details	Indication	Details
	0		A		0	No Main address	0~9	100 -digit	0~9	10 -digit	0~9	A unit digit
1				1	Main address setting mode							
Option	SEG7		SEG8		SEG9		SEG10		SEG11		SEG12	
Explanation	PAGE				Setting RMC address				Group channel(*16)		Group address	
Remote Controller Display												
Indication and Details	Indication	Details			Indication	Details			Indication	Details	Indication	Details
	1				0	No RMC address			RMC1	0~F	RMC2	0~F
				1	RMC address setting mode							

CAUTION

- When "A"~"F" is entered to SEG5~6, the indoor unit MAIN ADDRESS is not changed.
- If you set the SEG 3 as 0, the indoor unit will maintain the previous MAIN ADDRESS even if you input the option value of SEG5~6.
- If you set the SEG 9 as 0, the indoor unit will maintain previous RMC ADDRESS even if you input the option value of SEG11~12.
- You cannot set SEG11 and SEG12 as F value at the same time.

Setting an indoor unit installation option (suitable for the condition of each installation location)

1. Check whether power is supplied or not.
 - When the indoor unit is not plugged in, there should be additional power supply in the indoor unit.
2. The panel(display) should be connected to an indoor unit to receive option.
3. Set the installation option according to the installation condition of an air conditioner.
 - The default setting of an indoor unit installation option is "020010-100000-200000-300000".
 - Individual control of a remote controller(SEG20) is the function that controls an indoor unit individually when there is more than one indoor unit.
4. Set the indoor unit option by wireless remote controller.

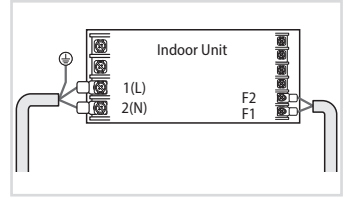

O2 series installation option

SEG1	SEG2	SEG3	SEG4	SEG5	SEG6
0	2	-	External room temperature sensor / Minimizing fan operation when thermostat is off	Central control	FAN RPM compensation
SEG7	SEG8	SEG9	SEG10	SEG11	SEG12
1	Drain pump	Hot water heater	-	EEV Step when heating stops	-
SEG13	SEG14	SEG15	SEG16	SEG17	SEG18
2	External control	External control output / External heater On or Off signal	S-Plasma ion	Buzzer	Number of hours using filter
SEG19	SEG20	SEG21	SEG22	SEG23	SEG24
3	Individual control of a remote controller	Heating setting compensation / Removing condensated water in heating mode	EEV Step of stopped unit during oil return/defrost mode	Motion detect sensor	-

- 1WAY / 2WAY / 4WAY MODEL: Drain pump(SEG8) will be set to 'USE + 3minute delay' even if the drain pump is set to 0.
- 1WAY / 2WAY / 4WAY, DUCT MODEL : Number of hours using filter(SEG18) will be set to '1000hour' even if the SEG18 is set to except for 2 or 6.
- When setting the option other than above SEG values, the option will be set as "0".
- SEG5 central control option is basically set as 1 (Use), so you don't need to set the central control option additionally. However, if the central control is not connected but it doesn't indicate an error message, you need to set the central control option as 0 (Disuse) to exclude the indoor unit from the central control.
- The output of hot water heater in SEG9 is generated from the hot coil part of the terminal board in duct models.

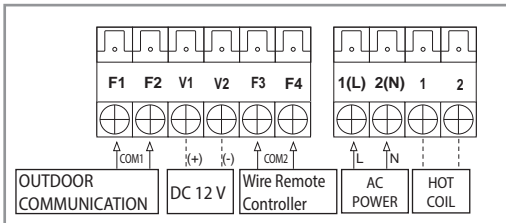

* The output of hot coil terminal is AC 220 V / 230 V (The same as Indoor Unit's input Power)

- The external output of SEG15 is generated by MIM-B14 connection. (Refer to the manual of MIM-B14.)

Setting an indoor unit address and installation option

02 series installation option(Detailed)

Option No. : 02XXXX-1XXXXX-2XXXXX-3XXXXX

Option	SEG1		SEG2		SEG3		SEG4			SEG5		SEG6		
Explanation	PAGE		MODE		Use of robot cleaning		Use of external room temperature sensor / Minimizing fan operation when thermostat is off			Use of central control		FAN RPM compensation		
Remote Controller Display														
Indication and Details	Indication	Details	Indication	Details	Indication	Details	Indication	Details		Indication	Details	Indication	Details	
	0		2		0	Disuse	0	Disuse	Disuse	0	Disuse	0	Disuse	
					1	Use	1	Use	Disuse	1	Use	1	RPM compensation	
					2	Disuse	2	Disuse	Use (*1)	1	Use	2	High ceiling KIT	
Option	SEG7		SEG8		SEG9		SEG10			SEG11		SEG12		
Explanation	PAGE		Use of drain pump		Use of hot water heater					EEV Step when heating stops				
Remote Controller Display														
Indication and Details	Indication	Details	Indication	Details	Indication	Details	Indication	Details		Indication	Details	Indication	Details	
	1		0	Disuse	0	Disuse				0	Default value			
			1	Use	1	Use (*2)				1	Noise decreasing setting			
			2	When an indoor unit stops, drain pump will operate for 3min.	2	-								
Option	SEG13		SEG14		SEG15			SEG16			SEG17		SEG18	
Explanation	PAGE		Use of external control		Setting the output of external control / External heater On/ Off signal			S-Plasma ion			Buzzer control		Number of hours using filter	
Remote Controller Display														
Indication and Details	Indication	Details	Indication	Details	Indication	Details		Indication	Details		Indication	Details	Indication	Details
	2		0	Disuse	0	Thermo on	-	0	Disuse		0	Use buzzer	2	1000 Hour
			1	ON/OFF control	1	Operation on	-							
			2	OFF control	2	-	Use (*3)	1	Use		1	Disuse buzzer	6	2000 Hour
			3	Window ON/OFF control	3	-	Use (*3)							

Option	SEG19	SEG20	SEG21	SEG22	SEG23	SEG24						
Explanation	PAGE	Individual control of a remote controller	Heating setting compensation / Removing condensated water in heating mode	EEV Step of stopped unit during oil return/ defrost mode	Motion detect sensor	-						
Remote Controller Display												
Indication and Details	Indication	Details	Details				Indication	Details				
			Indication	Details	Indication	Details			Indication	Details		
	3	0 or 1	channel 1	0	Default(*4)	Disuse	0	Default value	0	Disuse		
			2	1	2°C	Disuse			1	Turn out in 30min. without motion		
			3	2	5°C	Disuse			2	Turn out in 60min. without motion		
		4	channel 3	3	Default(*4)	Use (*5)			3	Turn out in 120min. without motion		
			4	2°C	Use (*5)	4			Turn out in 180min. without motion			
		4	channel 4	5	5°C	Use (*5)			1	Oil return or Noise decreasing in defrost mode	5	Turn out in 30min. without motion or *advanced function
											6	Turn out in 60min. without motion or *advanced function
											7	Turn out in 120min. without motion or *advanced function
8	Turn out in 180min. without motion or *advanced function											

* Advanced function: Controlling cooling/heating current or power saving with motion detect.

(*) Minimizing fan operation when thermostat is off

- Fan operates for 20 seconds at an interval of 5 minutes in heat mode.

(***) 1: Fan is turned on continually when the hot water heater is turned on,

3: Fan is turned off when the hot water heater is turned on with cooling only indoor unit

Cooling only indoor unit: To use this option, install the Mode Select switch (MCM-C200) on the outdoor unit and fix it as cool mode.

(****) When the following 2 or 3 is used as external heater On/Off signal, the signal for monitoring external contact control will not be output.

2: Fan is turned on continually when the external heater is turned on,

3: Fan is turned off when the external heater is turned on with cooling only indoor unit

Cooling only indoor unit: To use this option, install the Mode Select switch (MCM-C200) on the outdoor unit and fix it as cool mode.

※ If Fan is set to off for cooling only indoor unit by setting the SEG9=3 or SEG15=3, you need to use an external sensor or wired remote controller sensor to detect indoor temperature exactly.

(*) Default setting value

- 4Way Cassette, Mini 4Way Cassette: 5 °C

- Other indoor units: 2 °C

(*) This function can be applied to 4 Way Cassette and Mini 4 Way Cassette only. If the air conditioner operates the heating mode immediately after finishing the cooling mode, the condensated water in the drain pan becomes water vapor by the heat of the indoor unit heat exchanger. Since the water vapor might be condensed on the indoor unit, which may fall into a living space, use this function to get rid of the water vapor out of the indoor unit by operating the fan (for maximum 20 minutes) even when the indoor unit is turned off after cooling mode is turned to heating mode .

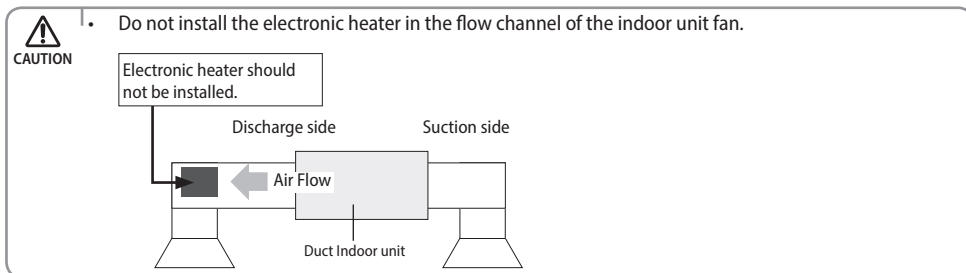

Setting an indoor unit address and installation option

05 series installation option

SEG1	SEG2	SEG3	SEG4	SEG5	SEG6
0	5	Use of Auto Change Over for HR only in Auto mode	(When setting SEG3) Standard heating temp. Offset	(When setting SEG3) Standard cooling temp. Offset	(When setting SEG3) Standard for mode change Heating → Cooling
SEG7	SEG8	SEG9	SEG10	SEG11	SEG12
1	(When setting SEG3) Standard for mode change Cooling → Heating	(When setting SEG3) Time required for mode change	Compensation option for Long pipe or height difference between indoor units	-	-
SEG13	SEG14	SEG15	SEG16	SEG17	SEG18
2	-	-	-	-	Control variables when using hot water / external heater
SEG19	SEG20	SEG21	SEG22	SEG23	SEG24
3	-	-	-	-	-

05 series installation option(Detailed)

Option No. : 05XXXX-1XXXX-2XXXX-3XXXX																				
Option	SEG1		SEG2		SEG3		SEG4		SEG5		SEG6									
Explanation	PAGE		MODE		Use of Auto Change Over for HR only in Auto mode		(When setting SEG3) Standard heating temp. Offset		(When setting SEG3) Standard cooling temp. Offset		(When setting SEG3) Standard for mode change Heating → Cooling									
Remote Controller Display																				
Indication and Details	Indication	Details	Indication	Details	Indication	Details	Indication	Details	Indication	Details	Indication	Details								
													0	5	0	0	0	0	0	1
													1	Use Auto Change Over for HR only	1	0.5	1	0.5	1	1.5
															2	1	2	1	2	2
															3	1.5	3	1.5	3	2.5
															4	2	4	2	4	3
															5	2.5	5	2.5	5	3.5
															6	3	6	3	6	4
7	3.5	7	3.5	7	4.5															
Option	SEG7		SEG8		SEG9		SEG10		SEG11		SEG12									
Explanation	PAGE		(When setting SEG3) Standard for mode change Cooling → Heating		(When setting SEG3) Time required for mode change		Compensation option for Long pipe or height difference between indoor units													
Remote Controller Display																				
Indication and Details	Indication	Details	Indication	Details	Indication	Details	Indication	Details	Indication	Details	Indication	Details								
													0	1	0	5 min.	0	Use default value		
													1	1.5	1	7 min.	1	1) Height difference ⁽¹⁾ is more than 30m or 2) Distance ⁽²⁾ is longer than 110m		
													2	2	2	9 min.				
													3	2.5	3	11 min.				
													4	3	4	13 min.	2	1) Height difference ⁽¹⁾ is 15~30m or 2) Distance ⁽²⁾ is 50~110m		
													5	3.5	5	15 min.				
													6	4	6	20 min.				
7	4.5	7	30 min.																	

Option	SEG13	SEG14	SEG15	SEG16	SEG17	SEG18 (*3)				
Explanation						Control variables when using hot water / external heater				
Remote Controller Display										
Indication and Details	2						Indication	Details		
								Set temp. for heater On/Off	Delay time for heater On	
								0	At the same time as thermo on	No delay
								1	At the same time as thermo on	10 minutes
								2	At the same time as thermo on	20 minutes
								3	1.5 °C	No delay
								4	1.5 °C	10 minutes
								5	1.5 °C	20 minutes
								6	3.0 °C	No delay
								7	3.0 °C	10 minutes
								8	3.0 °C	20 minutes
								9	4.5 °C	No delay
								A	4.5 °C	10 minutes
								B	4.5 °C	20 minutes
C	6.0 °C	No delay								
D	6.0 °C	10 minutes								
E	6.0 °C	20 minutes								

^{(*)1} Height difference : The difference of the height between the corresponding indoor unit and the indoor unit installed at the lowest place.

For example, When the indoor unit is installed 40m higher than the indoor unit installed at the lowest place, select the option "1"

^{(*)2} Distance : The difference between the pipe length of the indoor unit installed at farthest place from an outdoor unit and the pipe length of the corresponding indoor unit from an outdoor unit.

For example, when the farthest pipe length is 100m and the corresponding indoor unit is 40m away from an outdoor unit, select the option "2". (100 - 40 = 60m)

^{(*)3} Heater operation when the SEG9 of 02 series installation option is set to using hot water heater or when SEG15 is set to using external heater

e.g. 1) Setting 02 series SEG9 = "1" / Setting 05 series SEG18 = "0": Hot water heater is turned on at the same time as the heating thermostat is on, and turned off when the heating thermostat is off.

e.g. 2) Setting 02 series SEG15 = "2" / Setting 05 series SEG18 = "A":

Room temp. ≤ set temp. + f(heating compensation temp.)

- External heater is turned on when the temperature is maintained as 4.5 °C for 10 minutes.

Room temp. > set temp. + f(heating compensation temp.)

- External heater is turned off when the temperature is maintained as 4.5 °C + 1 °C (1 °C is the Hysteresis for On/Off selection.)

Setting an indoor unit address and installation option

SEG 3, 4, 5, 6, 8, 9 additional information



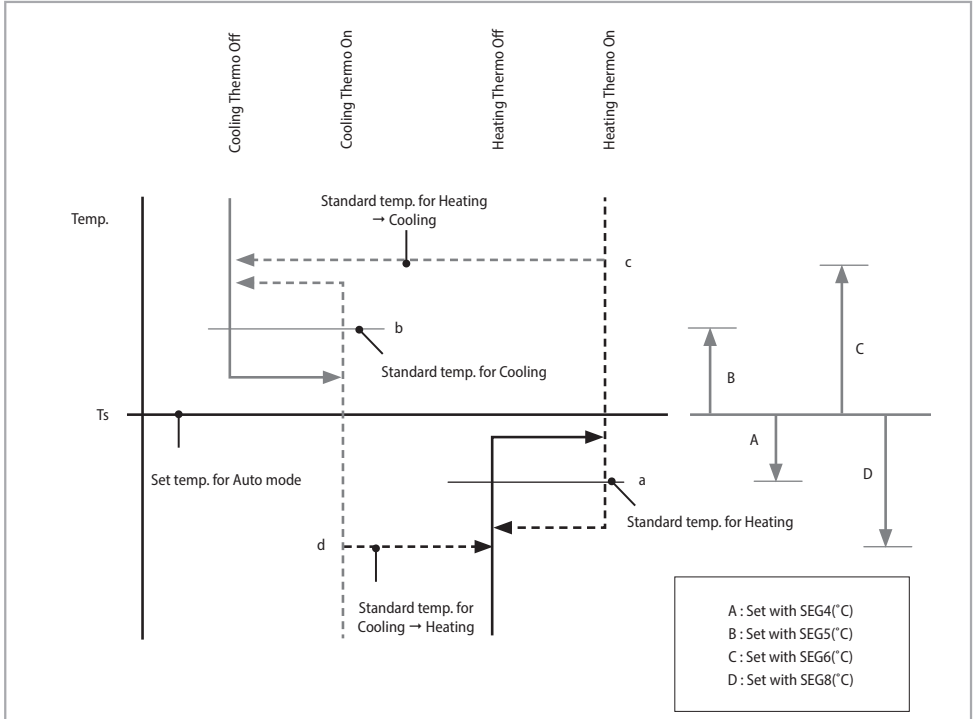

When the SEG 3 is set as "1" and follow Auto Change Over for HR only operation, it will operate as follows.



Cooling/Heating mode can be changed when Thermo Off status is maintained during the time with SEG9.

Changing a particular option

You can change each digit of set option.

Option	SEG1		SEG2		SEG3		SEG4		SEG5		SEG6	
Explanation	PAGE		MODE		The option mode you want to change		The tens' digit of an option SEG you will change		The unit digit of an option SEG you will change		The changed value	
Remote Controller Display												
Indication and Details	Indication	Details	Indication	Details	Indication	Details	Indication	Details	Indication	Details	Indication	Details
	0		D		Option mode	1~6	Tens' digit of SEG	0~9	Unit digit of SEG	0~9	The changed value	0~F



- When changing a digit of an indoor unit address setting option, set the SEG3 as 'A'.
- When changing a digit of indoor unit installation option, set the SEG3 as '2'.

Ex) When setting the 'buzzer control' into disuse status.

Option	SEG1	SEG2	SEG3	SEG4	SEG5	SEG6
Explanation	PAGE	MODE	The option mode you want to change	The tens' digit of an option SEG you will change	The unit digit of an option SEG you will change	The changed value
Indication	0	D	2	1	7	1



- If you are using heat pump model, mixed operation mode (two or more indoor units operating in different operation mode simultaneously) is not available when the indoor units are connected to same outdoor unit. If you set the master indoor unit with a remote controller, outdoor unit will operate in the mode which was set in the master indoor unit.

Setting temperature control of discharge air

1. Use of "Temperature control of discharge air" or target temperature of discharge air in cooling/heating can be set with the service mode of a wired remote controller. (Refer to the installation manual of a wired remote controller.)
 2. When using temperature control of discharge air, thermo on/off of Indoor unit is decided by set room temperature and room temperature, and the temperature of discharge air is adjusted to meet the target temperature of discharge air in thermostat On section.
 3. When using temperature control of discharge air, the temperature of discharge air cannot always be adjusted to the target temperature due to external conditions or protective control of the outdoor unit.
- ※ Temperature control of discharge air can be set with DMS as well.

Final Checks and User Tips

To complete the installation, perform the following checks and tests to ensure that the air conditioner operates correctly.

Check the followings.

- Strength of the installation site
- Tightness of pipe connection to detect a gas leak
- Electric wiring connections
- Heat-resistant insulation of the pipe
- Drainage
- Earth conductor connection
- Correct operation (follow the steps below)

Providing information for user

After finishing the installation of the air conditioner, you should explain the following to the user. Refer to appropriate pages in the User's Manual.

1. How to start and stop the air conditioner
2. How to select the modes and functions
3. How to adjust the temperature and fan speed
4. How to adjust the airflow direction
5. How to set the timers
6. How to clean and replace the filters



NOTE

- When you complete the installation successfully, hand over the User's Manual and this Installation Manual to the user for storage in a handy and safe place.

























Troubleshooting

Detection of errors





- If an error occurs during the operation, an LED flickers and the operation is stopped except the LED.
- If you re-operate the air conditioner, it operates normally at first, then detect an error again.

LED Display on the receiver & display unit

LED Display

Abnormal condition	Error code	LED Display				
						
Error on indoor temperature sensor (Short or Open)	E121	X	X		X	X
1. Error on Eva-in sensor (Short or Open)	E122		X		X	X
2. Error on Eva-out sensor (Short or Open)	E123		X		X	X
3. Discharge sensor error (Short or Open)	E126		X		X	X
Indoor fan error	E154	X	X	X		X
1. Error on outdoor temperature sensor (Short or Open)	E221		X	X		X
2. Error on cond sensor	E237		X	X		X
3. Error on discharge sensor	E251		X	X		X
Other outdoor unit sensor error that is not on the above list						
1. When there is no communication between the indoor-outdoor units for 2 minutes	E101					
2. Communication error received from the outdoor unit	E102					
3. 3 minute tracking error on outdoor unit	E202					
4. Communication error after tracking due to unmatching number of installed units	E201	X	X			X
5. Error due to repeated communication address	E108					
6. Communication address not confirmed	E109					
Other outdoor unit communication error that is not on the above list						
Self diagnosis error display						
1. Error due to opened EEV (2nd detection)	E151					
2. Error due to closed EEV (2nd detection)	E152					
3. Eva in sensor is detached	E128	X	X			
4. Eva out sensor is detached	E129					
5. Thermal fuse error (Open)	E198					

Troubleshooting

Abnormal condition	Error code	LED Display				
						
1. COND mid sensor is detached	E241					
2. Refrigerant leakage (2nd detection)	E554					
3. Abnormally high temperature on Cond (2nd detection)	E450					
4. Low pressure s/w (2nd detection)	E451					
5. Abnormally high temperature on discharged air on outdoor unit (2nd detection)	E416					
6. Indoor operation stop due to unconfirmed error on outdoor unit	E559					
7. Error due to reverse phase detection	E425					
8. Comp stop due to freeze detection (6th detection)	E403					
9. High pressure sensor is detached	E301	X	X	●	●	●
10. Low pressure sensor is detached	E306					
11. Outdoor unit copression ration error	E428					
12. Outdoor sump down_1 prevetion control	E413					
13. Compressor down due to low pressure sensor prevention control_1	E410					
14. Simultaneous opening of cooling/heating MCU SOL valve (1st detection)	E180					
15. Simultaneous opening of cooling/heating MCU SOL valve (2nd detection)	E181					
Other outdoor unit self-diagnosis error that is not on the above list						
Flowating s/w (2nd detection)	E153	X	X	X	●	●
EEPROM error	E162	●	●	●	●	●
EEPROM option error	E163	●	●	●	●	●
Error due to incompatible indoor unit	E164	X	X	X	X	●

● On ● Flickering X Off

- If you turn off the air conditioner when the LED is flickering, the LED is also turned off.
- If you re-operate the air conditioner, it operates normally at first, then detect an error again.
- When E108 error occurs, change the address and reset the system.

Ex.) When address of the indoor unit #1 and #2 are set as 5, address of the indoor unit #1 will become 5 and indoor unit #2 will display E108, A002.

Option table

E.S.P(External Static Pressure)setting for phase control motor

With its phase control motor, you can adjust the indoor unit fan speed depending on the installation condition. If the external static pressure is high so that the duct becomes longer or if the external static pressure is low so that the duct becomes shorter, adjust the fan speed by referring the following table.

Static Pressure(mmAq)		5	10	15	20	25	28
Model	Step	Option code for indoor unit					
AM220FNHDEH	HIGH						
	MID	011054-195097-20DCDC-331110	011054-1950C7-20DCDC-331110	011054-1950E8-20DCDC-331110	011054-19544D-20DCDC-331110	011054-19549F-20DCDC-331110	-
	LOW						
AM280FNHDEH	HIGH						
	MID	011054-195407-231C1C-331110	011054-195429-231C1C-331110	011054-19545B-231C1C-331110	011054-19549E-231C1C-331110	011054-1955D1-231C1C-331110	011054-1955F3-231C1C-331110
	LOW						



- [] represents E.S.P(External Static Pressure)range of factory setting. You don't have to adjust the fan speed separately if the external static pressure of the installation place is in []. When it is out of [], input the appropriate option code.
- If you input the inappropriate option code,error may occur or the air conditioner is out of order. The option code must be inputted correctly by the installation specialist or service agent.

Instruction for packing and unpacking the unit

- ▶ Packing the unit as below procedure.
 1. Put the indoor unit onto the packing case.
 2. Assemble cushion-both side of indoor unit. (Left and Right)
 3. Seal the packing case.

- ▶ Unpacking the unit as below procedure.
 1. Open the packing case.
 2. Take out the both side of cushion(Left and Right).
 3. Move the set from the packing case.

Technical specifications

MODEL		AM220FNHDEH/TK		AM280FNHDEH/TK	
CLIMATES CLASS		T1	T3	T1	T3
RATED VOLTAGE & FREQUENCY		220 - 240 V~ 50 Hz			
RATED CURRENT	COOLING	3.80 A	3.80 A	5.90 A	5.90 A
	HEATING(H1)	3.80 A		5.90 A	
RATED POWER INPUT	COOLING	530 W	530 W	790 W	790 W
	HEATING(H1)	530 W		790 W	
EER	COOLING	-	-	-	-
	HEATING(H1)	-		-	
NET WEIGHT		89 kg		89 kg	
DIMENSIONS OF THE UNIT [WxHxD]		1240 x 470 x 1040 mm			
COUNTRY OF ORIGIN		MADE IN KOREA			

SAMSUNG