

TOSHIBA

AIR TO WATER HEAT PUMP

Installation Manual

R32

Outdoor Unit

Model name:

HWT-401HW-E

HWT-601HW-E

HWT-801HW-E

HWT-1101HW-E

HWT-801HRW-E

HWT-1101HRW-E

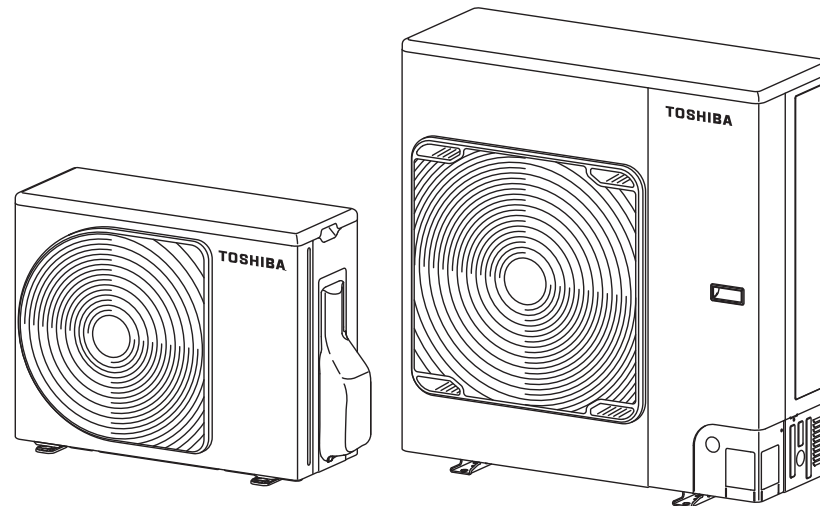

Original instructions

Please read this Installation Manual carefully before installing the Air to Water Heat Pump.

- This Manual describes the installation method of the Outdoor Unit.
- For installation of the Hydro Unit, follow the Installation Manual attached to the Hydro Unit.

REFRIGERANT

This Air to Water Heat Pump uses an HFC refrigerant (R32) in order to prevent destruction of the ozone layer.

▼ HWT-801HW-E, HWT-1101HW-E, HWT-801HRW-E, HWT-1101HRW-E

This equipment complies with IEC 61000-3-12 provided that the short-circuit power Ssc is greater than or equal to Ssc (*1) at the interface point between the user's supply and the public system. It is the responsibility of the installer or user of the equipment to ensure, by consultation with the distribution network operator if necessary, that the equipment is connected only to a supply with a short-circuit power Ssc greater than or equal to Ssc (*1).

Furthermore, when similar equipment or other equipment which may cause harmonic current emissions are to be connected to the same interface point with this equipment, to reduce the risk of possible problems which may be caused from addition of those harmonic current emissions, it is recommended to make sure that the short-circuit power Ssc at the interface point is greater than the sum of the minimum Ssc required by all the equipment which will be connected to the interface point.

Ssc (*1)

Model	Ssc (*1)(kVA)
HWT-801HW-E HWT-1101HW-E HWT-801HRW-E HWT-1101HRW-E	820

Contents

1	Precautions for safety	3
2	Accessory parts	6
3	Installation of R32 Air to Water Heat Pump	6
4	Installation conditions	7
5	Refrigerant piping	10
6	Air purging	12
7	Electrical work	15
8	Earthing	17
9	Finishing	17
10	Test run	17
11	Annual maintenance	17
12	Air to Water Heat Pump operating conditions	17
13	Functions to be implemented locally	17
14	Troubleshooting	19
15	Appendix	19

■ Generic denomination: Air to Water Heat Pump

■ Definition of qualified installer or qualified service person

The Air to Water Heat Pump must be installed, maintained, repaired and removed by a qualified installer or qualified service person. When any of these jobs is to be done, ask a qualified installer or qualified service person to do them for you.

A qualified installer or qualified service person is an agent who has the qualifications and knowledge described in the table below.

Agent	Qualifications and knowledge which the agent must have
Qualified installer	<ul style="list-style-type: none"> The qualified installer is a person who installs, maintains, relocates and removes the Air to Water Heat Pumps made by Toshiba Carrier Air-Conditioning Europe Sp. z o.o. He or she has been trained to install, maintain, relocate and remove the Air to Water Heat Pump made by Toshiba Carrier Air-Conditioning Europe Sp. z o.o. or, alternatively, he or she has been instructed in such operations by an individual or individuals who have been trained and is thus thoroughly acquainted with the knowledge related to these operations. The qualified installer who is allowed to do the electrical work involved in installation, relocation and removal has the qualifications pertaining to this electrical work as stipulated by the local laws and regulations, and he or she is a person who has been trained in matters relating to electrical work on the Air to Water Heat Pump made by Toshiba Carrier Air-Conditioning Europe Sp. z o.o. or, alternatively, he or she has been instructed in such matters by an individual or individuals who have been trained and is thus thoroughly acquainted with the knowledge related to this work. The qualified installer who is allowed to do the refrigerant handling and piping work involved in installation, relocation and removal has the qualifications pertaining to this refrigerant handling and piping work as stipulated by the local laws and regulations, and he or she is a person who has been trained in matters relating to refrigerant handling and piping work on the Air to Water Heat Pump made by Toshiba Carrier Air-Conditioning Europe Sp. z o.o. or, alternatively, he or she has been instructed in such matters by an individual or individuals who have been trained and is thus thoroughly acquainted with the knowledge related to this work. The qualified installer who is allowed to work at heights has been trained in matters relating to working at heights with the Air to Water Heat Pump made by Toshiba Carrier Air-Conditioning Europe Sp. z o.o. or, alternatively, he or she has been instructed in such matters by an individual or individuals who have been trained and is thus thoroughly acquainted with the knowledge related to this work.
Qualified service person	<ul style="list-style-type: none"> The qualified service person is a person who installs, repairs, maintains, relocates and removes the Air to Water Heat Pump made by Toshiba Carrier Air-Conditioning Europe Sp. z o.o. He or she has been trained to install, repair, maintain, relocate and remove the Air to Water Heat Pump made by Toshiba Carrier Air-Conditioning Europe Sp. z o.o. or, alternatively, he or she has been instructed in such operations by an individual or individuals who have been trained and is thus thoroughly acquainted with the knowledge related to these operations. The qualified service person who is allowed to do the electrical work involved in installation, repair, relocation and removal has the qualifications pertaining to this electrical work as stipulated by the local laws and regulations, and he or she is a person who has been trained in matters relating to electrical work on the Air to Water Heat Pump made by Toshiba Carrier Air-Conditioning Europe Sp. z o.o. or, alternatively, he or she has been instructed in such matters by an individual or individuals who have been trained and is thus thoroughly acquainted with the knowledge related to this work. The qualified service person who is allowed to do the refrigerant handling and piping work involved in installation, repair, relocation and removal has the qualifications pertaining to this refrigerant handling and piping work as stipulated by the local laws and regulations, and he or she is a person who has been trained in matters relating to refrigerant handling and piping work on the Air to Water Heat Pump made by Toshiba Carrier Air-Conditioning Europe Sp. z o.o. or, alternatively, he or she has been instructed in such matters by an individual or individuals who have been trained and is thus thoroughly acquainted with the knowledge related to this work. The qualified service person who is allowed to work at heights has been trained in matters relating to working at heights with the Air to Water Heat Pump made by Toshiba Carrier Air-Conditioning Europe Sp. z o.o. or, alternatively, he or she has been instructed in such matters by an individual or individuals who have been trained and is thus thoroughly acquainted with the knowledge related to this work.

■ Definition of protective gear





When the Air to Water Heat Pump is to be transported, installed, maintained, repaired or removed, wear protective gloves and "safety" work clothing.





In addition to such normal protective gear, wear the protective gear described below when undertaking the special work detailed in the table below.

Failure to wear the proper protective gear is dangerous because you will be more susceptible to injury, burns, electric shocks and other injuries.

Work undertaken	Protective gear worn
All types of work	Protective gloves "Safety" working clothing
Electrical-related work	Gloves to provide protection for electricians and from heat Insulating shoes Clothing to provide protection from electric shock
Work done at heights (50 cm or more)	Helmets for use in industry
Transportation of heavy objects	Shoes with additional protective toe cap
Repair of Outdoor Unit	Gloves to provide protection for electricians and from heat

Warning Indications on the Air to Water Heat Pump Unit

	WARNING (Risk of fire)	This mark is for R32 refrigerant only. Refrigerant type is written on nameplate of Outdoor Unit. In case that refrigerant type is R32, this unit uses a flammable refrigerant. If refrigerant leaks and comes in contact with fire or heating part, it will create harmful gas and there is risk of fire.
	Read the OWNER'S MANUAL carefully before operation.	
	Service personnel are required to carefully read the OWNER'S MANUAL and INSTALLATION MANUAL before operation.	
	Further information is available in the OWNER'S MANUAL, INSTALLATION MANUAL, and the like.	

Warning indication	Description		
 <table border="1"> <tr> <td>WARNING</td> </tr> <tr> <td>ELECTRICAL SHOCK HAZARD Disconnect all remote electric power supplies before servicing.</td> </tr> </table>	WARNING	ELECTRICAL SHOCK HAZARD Disconnect all remote electric power supplies before servicing.	WARNING ELECTRICAL SHOCK HAZARD Disconnect all remote electric power supplies before servicing.
WARNING			
ELECTRICAL SHOCK HAZARD Disconnect all remote electric power supplies before servicing.			
 <table border="1"> <tr> <td>WARNING</td> </tr> <tr> <td>Moving parts. Do not operate unit with grille removed. Stop the unit before the servicing.</td> </tr> </table>	WARNING	Moving parts. Do not operate unit with grille removed. Stop the unit before the servicing.	WARNING Moving parts. Do not operate unit with grille removed. Stop the unit before the servicing.
WARNING			
Moving parts. Do not operate unit with grille removed. Stop the unit before the servicing.			
 <table border="1"> <tr> <td>CAUTION</td> </tr> <tr> <td>High temperature parts. You might get burned when removing this panel.</td> </tr> </table>	CAUTION	High temperature parts. You might get burned when removing this panel.	CAUTION High temperature parts. You might get burned when removing this panel.
CAUTION			
High temperature parts. You might get burned when removing this panel.			
 <table border="1"> <tr> <td>CAUTION</td> </tr> <tr> <td>Do not touch the aluminum fins of the unit. Doing so may result in injury.</td> </tr> </table>	CAUTION	Do not touch the aluminum fins of the unit. Doing so may result in injury.	CAUTION Do not touch the aluminium fins of the unit. Doing so may result in injury.
CAUTION			
Do not touch the aluminum fins of the unit. Doing so may result in injury.			
 <table border="1"> <tr> <td>CAUTION</td> </tr> <tr> <td>BURST HAZARD Open the service valves before the operation, otherwise there might be the burst.</td> </tr> </table>	CAUTION	BURST HAZARD Open the service valves before the operation, otherwise there might be the burst.	CAUTION BURST HAZARD Open the service valves before the operation, otherwise there might be the burst.
CAUTION			
BURST HAZARD Open the service valves before the operation, otherwise there might be the burst.			

1 Precautions for safety

- Ensure that all Local, National and International regulations are satisfied.
- Read this “Precautions for safety” carefully before Installation.
- The precautions described below include the important items regarding safety.
Observe them without fail.
- After the installation work, perform a test run to check for any problem. Follow the Owner’s Manual to explain how to use and maintain the unit to the customer.
- Turn off the main power supply switch (or breaker) before the unit maintenance.
- Ask the customer to keep the Installation Manual together with the Owner’s Manual.

WARNING

- **Ask an authorized dealer or qualified installation professional to install / maintain the Air to Water Heat Pump.**
Inappropriate installation may result in water leakage, electric shock or fire.
- **Be sure to connect earth wire. (grounding work)**
Incomplete grounding cause an electric shock.
Do not connect ground wires to gas pipes, water pipes, lightning rods or ground wires for telephone wires.
- **Turn off the main power supply switch or breaker before attempting any electrical work.**
Make sure all power switches are off. Failure to do so may cause electric shock.
Use an exclusive power circuit for the Air to Water Heat Pump. Use the rated voltage.
- **Connect the system interconnection wire correctly.**
If the system interconnection wire is connected in a wrong way, electric parts may be damaged.
- **When moving the Air to Water Heat Pump for the installation into another place, be very careful not to enter any gaseous matter other than the specified refrigerant into the refrigeration cycle.**
If air or any other gas is mixed in the refrigerant, the gas pressure in the refrigeration cycle becomes abnormally high and it may resultingly causes pipe burst and injuries on persons.

- **Do not modify this unit by removing any of the safety guards or by by-passing any of the safety interlock switches.**
- **After unpacking the unit, examine it carefully if there are possible damage.**
- **Do not install in a place that might increase the vibration of the unit.**
- **To avoid personal injury (with sharp edges), be careful when handling parts.**
- **Perform installation work properly according to the Installation Manual.**

Inappropriate installation may result in water leakage, electric shock or fire.

- **When the Air to Water Heat Pump Hydro Unit is installed in a small room, provide appropriate measures to ensure that the concentration of refrigerant leakage occur in the room does not exceed the critical level.**
- **Tighten the flare nut with a torque wrench in the specified manner.** Excessive tightening of the flare nut may cause a crack in the flare nut after a long period, which may result in refrigerant leakage.
- **Wear heavy gloves during the installation work to avoid injury.**
- **Install the Air to Water Heat Pump securely in a location where the base can sustain the weight adequately.**
- **Perform the specified installation work to guard against an earthquake.**

If the Air to Water Heat Pump is not installed appropriately, accidents may occur due to the falling unit.

- **If refrigerant gas has leaked during the installation work, ventilate the room immediately.**

If the leaked refrigerant gas comes in contact with fire, noxious gas may generate.

- **After the installation work, confirm that refrigerant gas does not leak.**

If refrigerant gas leaks into the room and flows near a fire source, such as a cooking range, noxious gas might generate.

- **Electrical work must be performed by a qualified electrician in accordance with the Installation Manual.**
Make sure the Air to Water Heat Pump uses a dedicated power supply.

An insufficient power supply capacity or inappropriate installation may cause fire.

- **Use the specified wires for wiring connect the terminals securely fix.**

To prevent external forces applied to the terminals from affecting the terminals.

- **When the Air to Water Heat Pump cannot cool or heat water well, contact the dealer from whom you purchased the Air to Water Heat Pump as refrigerant leakage is considered as the cause. In the case of repair that requires refill of refrigerant, ask service personnel about details of the repair.**

The refrigerant used in the Air to Water Heat Pump is harmless.

Generally, the refrigerant does not leak. However, if the refrigerant leaks in a room and a heater or stove burner in the room catches fire, it may generate toxic gas.

When you ask service personnel for repairing refrigerant leakage, confirm that the leakage portion has been completely repaired.

- **Conform to the regulations of the local electric company when wiring the power supply.**

Inappropriate grounding may cause electric shock.

- **Do not install the Air to Water Heat Pump in a location subject to a risk of exposure to a combustible gas.**

If a combustible gas leaks, and stays around the unit, a fire may occur.

- **Install the refrigerant pipe securely during the installation work before operating the Air to Water Heat Pump.**

If the compressor is operated with the valve open and without the refrigerant pipe, the compressor sucks air and the refrigeration cycle is overpressurized, which may cause a burst or injury.

- **For the refrigerant recovery work (collection of refrigerant from the pipe to the compressor), stop the compressor before disconnecting the refrigerant pipe.**

If the refrigerant pipe is disconnected while the compressor is working with the valve open, the compressor sucks air and the refrigeration cycle is overpressurized, which may cause a burst or injury.

- **Do not use means to accelerate the defrosting process or to clean, other than those recommended by the manufacturer.**

- **The appliance shall be stored in a room without continuously operating ignition sources (for example: open flames, an operating gas appliance or an operating electric heater).**

- **Do not pierce or burn.**

- **Be aware that refrigerants may not contain an odour.**

- **The installation of pipe-work shall be kept to a minimum.**

- The pipe-work shall be protected from physical damage.
- Compliance with national gas regulations shall be observed.

⚠ CAUTION

This Air to Water Heat Pump adopts the HFC refrigerant (R32) which does not destroy the ozone layer.

- R32 refrigerant has a high working pressure and is apt to be affected by impurities such as water, oxidizing membrane, and oils. Therefore, during installation work, be careful that water, dust, previous refrigerant, refrigerating machine oil, or other substances do not enter the R32 refrigeration cycle.
- Special tools for R32 or R410A refrigerant are required for installation.
- For connecting pipes, use new and clean piping materials, and make sure that water and/or dust does not enter.

Cautions for Outdoor Unit installation space

- In the event that the Outdoor Unit is installed in a small space and refrigerant leaks, accumulation of highly concentrated refrigerant may cause a fire hazard. Therefore, be sure to follow the installation space instructions in the Installation Manual, and provide open space on at least one of the four Outdoor Unit sides.
- In particular, when both the discharge and intake sides face walls and obstacles are also placed on both sides of the Outdoor Unit, take steps to provide space wide enough for a person to pass (600 mm or more) on one side to prevent leaked refrigerant from accumulating.

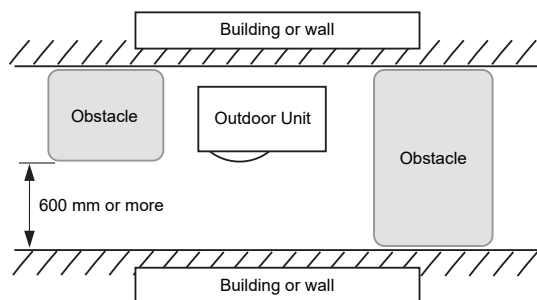

To disconnect the product from main power supply

- This product must be connected to the main power supply by means of a switch with a contact separation of at least 3 mm.













Do not wash Air to Water Heat Pump with pressure washers

- Electric leaks may cause electric shocks or fires.

Precautions for recovery of refrigerant when servicing or relocating unita

- When removing refrigerant from a system, either for servicing or decommissioning, it is recommended good practice that all refrigerants are removed safely.
- When transferring refrigerant into cylinders, ensure that only appropriate refrigerant recovery cylinders are employed. Ensure that the correct number of cylinders for holding the total system charge is available. All cylinders to be used are designated for the recovered refrigerant and labelled for that refrigerant (i.e. special cylinders for the recovery of refrigerant). Cylinders shall be complete with pressure-relief valve and associated shut-off valves in good working order. Empty recovery cylinders are evacuated and, if possible, cooled before recovery occurs.
- The recovery equipment shall be in good working order with a set of instructions concerning the equipment that is at hand and shall be suitable for the recovery of all appropriate refrigerants including, when applicable, flammable refrigerants. In addition, a set of calibrated weighing scales shall be available and in good working order. Hoses shall be complete with leak-free disconnect couplings and in good condition. Before using the recovery machine, check that it is in satisfactory working order, has been properly maintained and that any associated electrical components are sealed to prevent ignition in the event of a refrigerant release. Consult manufacturer if in doubt.
- The recovered refrigerant shall be returned to the refrigerant supplier in the correct recovery cylinder, and the relevant waste transfer note arranged. Do not mix refrigerants in recovery units and especially not in cylinders.
- If compressors or compressor oils are to be removed, ensure that they have been evacuated to an acceptable level to make certain that flammable refrigerant does not remain within the lubricant. The evacuation process shall be carried out prior to returning the compressor to the suppliers. Only electric heating to the compressor body shall be employed to accelerate this process. When oil is drained from a system, it shall be carried out safely.

2 Accessory parts

Part name	Qty		Shape	Usage
	HWT-40,60	HWT-80,110		
Outdoor Unit installation manual	1	1		Hand this directly to the customer.
Drain nipple *	1	1		
Waterproof rubber cap A *	-	4	 Waterproof rubber cap A	
Waterproof rubber cap B *	2	1	 Waterproof rubber cap B	
Protective bush	-	1		For protecting wires (pipe cover)
Guard material for passage part	-	1		For protecting passage part (pipe cover)
Energy label	1	1		
Product fiche	1	1		
WEEE Manual WEEE : Waste electrical and electronic equipment	1	1		
F-Gas label	1	1		
Protection sheet	1	1		
Cable tie	-	4	-	
Clamp filter	-	1		For conforming to EMC standards

* (HWT-80*HRW-E, HWT-110*HRW-E) are not eligible.

3 Installation of R32 Air to Water Heat Pump

⚠ CAUTION

R32 refrigerant Air to Water Heat Pump installation

- This Air to Water Heat Pump adopts the HFC refrigerant (R32) which does not destroy ozone layer.

Therefore, during installation work, make sure that water, dust, former refrigerant, or refrigerant oil does not enter the R32 refrigerant Air to Water Heat Pump cycle. To prevent mixing of refrigerant or refrigerant oil, the sizes of connecting sections of charge port on the main unit and installation tools are different from those of the conventional refrigerant units.

Accordingly, special tools are required for the R32 or R410A refrigerant units. For connecting pipes, use new and clean piping materials with high pressure fittings made for the R32 or R410A only, so that water and/or dust does not enter.

- When using existing piping, refer to "15 APPENDIX - [1] Existing piping".

■ Required Tools/Equipment and Precautions for Use

Prepare the tools and equipment listed in the following table before starting the installation work. Newly prepared tools and equipment must be used exclusively.

Legend

△ : Conventional tools (R32 or R410A)

⊙ : Prepared newly (Use for R32 only)

Tools / equipment	Use	How to use tools / equipment
Gauge manifold	Vacuuming / charging refrigerant and operation check	△ Conventional tools (R410A)
Charging hose		△ Conventional tools (R410A)
Charging cylinder	Can not be used	Unusable (Use the electronic refrigerant charging scale)
Gas leak detector	Charging refrigerant	△ Conventional tools (R32 or R410A)
Vacuum pump	Vacuum drying	△ Conventional tools (R32 or R410A) Usable if the backflow prevention adapter is installed.
Vacuum pump with backflow prevention function	Vacuum drying	△ Conventional tools (R32 or R410A)
Flare tool	Flare machining of pipes	△ Conventional tools (R410A)
Bender	Bending pipes	△ Conventional tools (R410A)
Refrigerant recovery equipment	Refrigerant recovery	△ Conventional tools (R32 or R410A)
Torque wrench	Tightening flare nuts	△ Conventional tools (R410A)
Pipe cutter	Cutting pipes	△ Conventional tools (R410A)
Refrigerant cylinder	Charging refrigerant	⊙ Prepared newly (Use for R32 only)
Welding machine and nitrogen cylinder	Welding pipes	△ Conventional tools (R410A)
Electronic refrigerant charging scale	Charging refrigerant	△ Conventional tools (R32 or R410A)

■ Refrigerant Piping

R32 refrigerant

⚠ CAUTION

- Incomplete flaring may cause refrigerant gas leakage.
- Do not re-use flares. Use new flares to prevent refrigerant gas leakage.
- Use flare nuts that are included with the unit. Using different flare nuts may cause refrigerant gas leakage.

Use the following item for the refrigerant piping.

Material : Seamless phosphorous deoxidized copper pipe.

Ø6.35, Ø9.52, Ø12.7 Wall thickness 0.8 mm or more

Ø15.88 Wall thickness 1.0 mm or more

REQUIREMENT

When the refrigerant pipe is long, provide support brackets at intervals of 2.5 to 3 m to clamp the refrigerant pipe. Otherwise, abnormal sound may be generated.

4 Installation conditions

■ Before installation

Be sure to prepare to the following items before installation.

Length of refrigerant pipe

Length of refrigerant pipe connected to Hydro / Outdoor Unit	Item
5 to 30 m	Addition of refrigerant at the local site is unnecessary for refrigerant pipe length up to 8 m*. If the refrigerant pipe length exceeds 8 m*, add refrigerant in the amount given in "Replenishing refrigerant"

Caution during addition of refrigerant. Charge the refrigerant accurately. Overcharging may cause serious trouble with the compressor.

- Do not connect a refrigerant pipe that is shorter than 5 m.

This may cause a malfunction of the compressor or other devices.

* HWT-40, 60: 20 m

■ Airtight test

1. Before starting an airtight test, further tighten the spindle valves on the gas and liquid sides.
 2. Pressurize the pipe with nitrogen gas charged from the service port to the design pressure (4.15 MPa*) to conduct an airtight test.
 3. After the airtight test is completed, evacuate the nitrogen gas.
- * HWT-801/1101H(R)W-E: 4.6 MPa

Air purge

- To purge air, use a vacuum pump.
- Do not use refrigerant charged in the Outdoor Unit to purge air. (The air purge refrigerant is not contained in the Outdoor Unit.)

Electrical wiring

- Be sure to fix the power wires and Hydro / Outdoor connecting wires with clamps so that they do not come into contact with the cabinet, etc.

Earthing

⚠ WARNING

Make sure that proper earthing is provided.

Improper earthing may cause an electric shock. For details on how to check earthing, contact the dealer who installed the Air to Water Heat Pump or a professional installation company.

- Proper earthing can prevent charging of electricity on the Outdoor Unit surface due to the presence of a high frequency in the frequency converter (inverter) of the Outdoor Unit, as well as prevent electric shock. If the Outdoor Unit is not properly earthed, you may be exposed to an electric shock.
- **Be sure to connect the earth wire. (Grounding work)**
Incomplete earthing can cause an electric shock. Do not connect earth wires to gas pipes, water pipes, lightning rods or earth wires for telephone wires.

Test run

Turn on the leakage breaker at least 12 hours before starting a test run to protect the compressor during startup.

■ Installation location

⚠ WARNING

Install the Outdoor Unit properly in a location that is durable enough to support the weight of the Outdoor Unit.

Insufficient durability may cause the Outdoor Unit to fall, which may result in injury.
Pay special attention when installing the unit onto a wall surface.

⚠ CAUTION

Do not install the Outdoor Unit in a location that is subject to combustible gas leaks.
Accumulation of combustible gas around the Outdoor Unit may cause a fire.

Install the Outdoor Unit in a location that meets the following conditions after the customer's consent is obtained.

- A well-ventilated location free from obstacles near the air inlets and air outlet.
- A location that is not exposed to rain or direct sunlight.
- A location that does not increase the operating noise or vibration of the Outdoor Unit.
- A location that does not produce any drainage problems from discharged water.
- A degree of ventilation shall continue during the period that the work is carried out.
- The ventilation should safely disperse any released refrigerant and preferably expel it externally into the atmosphere.

Do not install the Outdoor Unit in the following locations.

- A location with a saline atmosphere (coastal area) or one that is full of sulfide gas (hot-spring area) (Special maintenance is required).
- A location subject to oil, vapor, oily smoke, or corrosive gases.
- A location in which organic solvent is used.
- Places where iron or other metal dust is present. If iron or other metal dust adheres to or collects on the interior of the Air to Water Heat Pump, it may spontaneously combust and start a fire.
- A location where high-frequency equipment (including inverter equipment, private power generator, medical equipment, and communication equipment) is used (Installation in such a location may cause malfunction of the Air to Water Heat Pump, abnormal control or problems due to noise from such equipment).
- A location in which the discharged air of the Outdoor Unit blows against the window of a neighboring house.

- A location where the operating noise of the Outdoor Unit is transmitted.
- When the Outdoor Unit is installed in an elevated position, be sure to secure its feet.
- A location in which drain water poses any problems.

⚠ CAUTION

1. Install the Outdoor Unit in a location where the discharge air is not blocked.
2. When an Outdoor Unit is installed in a location that is always exposed to strong winds like a coast or on the high stories of a building, secure normal fan operation by using a duct or wind shield.
3. When installing the Outdoor Unit in a location that is constantly exposed to strong winds such as on the upper stairs or rooftop of a building, apply the windproofing measures referred to in the following examples.
 - 1) Install the unit so that its discharge port faces the wall of the building.
Keep a distance 500 mm or more between the unit and wall surface.

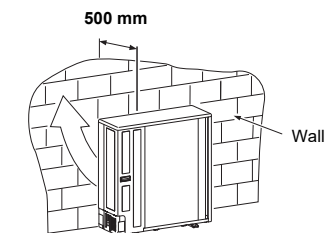

- 2) Consider the wind direction during the operational season of the Air to Water Heat Pump, and install the unit so that the discharge port is set at a right angle relative to the wind direction.

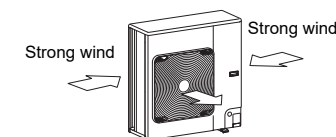

- When using an Air to Water Heat Pump under low outside temperature conditions, prepare a duct or snow hood so that it is not affected by the snow.

<Example>

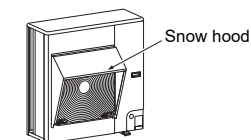

■ Necessary Space for Installation (Unit: mm)

Single unit installation

When there is an obstacle on the back side
(Front, sides, and top are free)

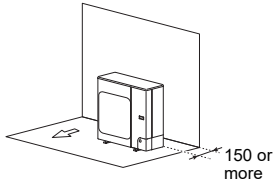

When there is an obstacle on the front side
(Back, sides, and top are free)

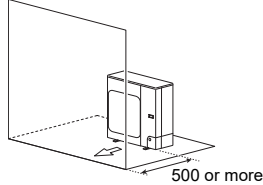

When there are obstacles on the front and back sides
(Sides and top are free)

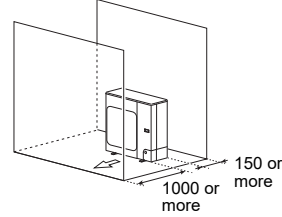

When there are obstacles on the top and front sides
(Back and sides are free)

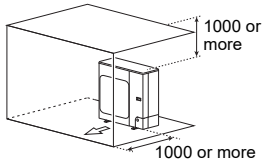

When there are obstacles on the back and top sides
(Front and sides are free)

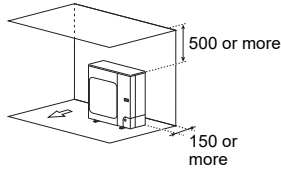

When there are obstacles on the back and sides
(Front and top are free)

* The height of the obstacle should be lower than that of the Outdoor Unit.

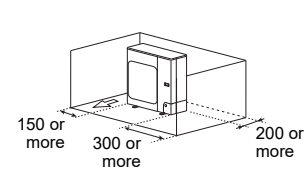

Serial unit installation

* When the outdoor temperature is high, the cooling capability may be decreased because of an equipment protection operation.

When there is an obstacle on the back side
(Front, sides, and top are free)

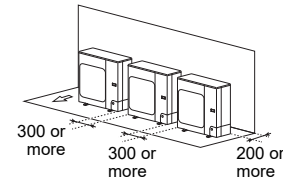

When there are obstacles on the back and top sides
(Front and sides are free)

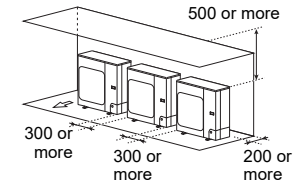

When there is an obstacle on the front side
(Back, sides, and top are free)

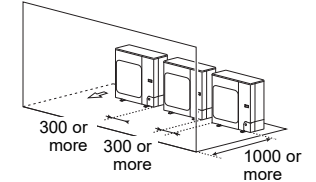

When there are obstacles on the back and sides
(Front and top are free)

* The height of the obstacle should be lower than that of the Outdoor Unit.

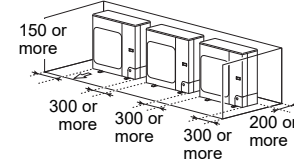

When there are obstacles on the front and back sides
(Sides and top are free)

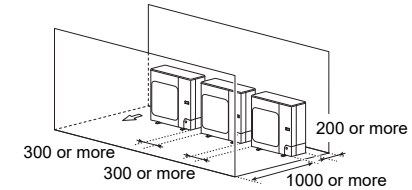

Single unit multiple-row installation

(Top and both sides are free)

* The height of the obstacle should be lower than that of the Outdoor Unit.

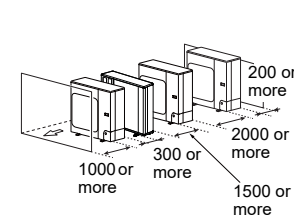

Multiple unit multiple-row installation

(Top, both sides, and front are free)

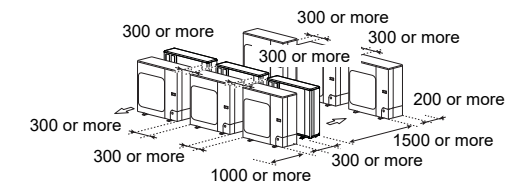

Installation of Outdoor Unit

- Before installation, check the strength and horizontalness of the base so that abnormal sounds do not emanate.
- According to the following base diagram, fix the base firmly with the anchor bolts.
(Anchor bolt, nut: M10 x 4 pairs)

<HWT-40, 60>

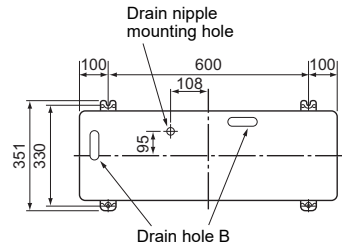

<HWT-80, 110>

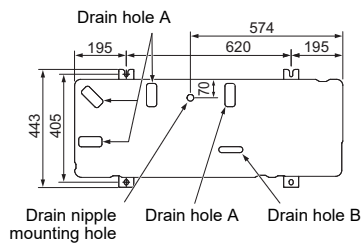

- As shown in the figure below, install the foundation and vibration-proof rubber pads to directly support the bottom surface of the fixing leg that is in contact with and underneath the bottom plate of the Outdoor Unit.
- * When installing the foundation for an Outdoor Unit with downward piping, consider the piping work.

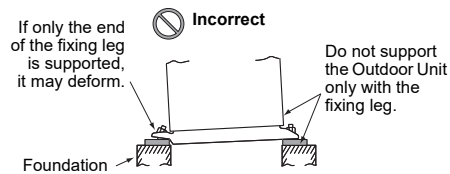
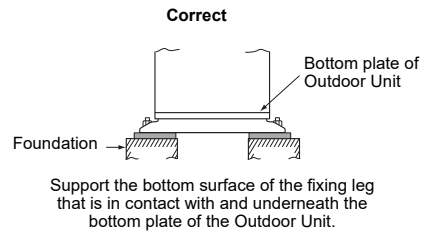
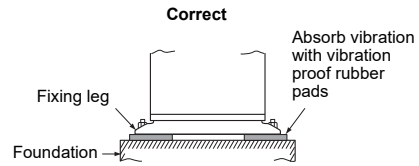

Set the out margin of the anchor bolt to 15 mm or less.

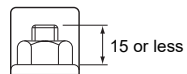

- When water is to be drained through the drain hose, attach the following drain nipple and waterproof rubber cap, and use the drain hose (Inner diam.: 16 mm) sold on the market. Also seal knockout hole and the screws securely with silicone material, etc., to prevent water from leaking. Some conditions may cause dewing or dripping of water.

- When collectively draining discharged water completely, use a drain pan.

<HWT-80, 110>

- * (HWT-80*HRW-E, HWT-110*HRW-E) are not eligible.

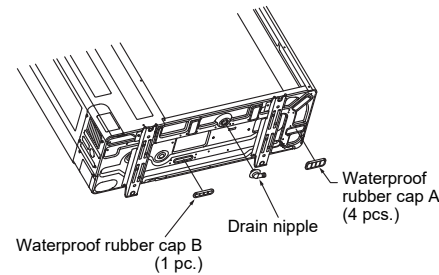
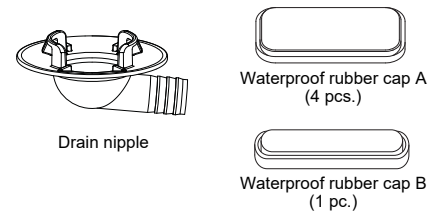

<HWT-40, 60>

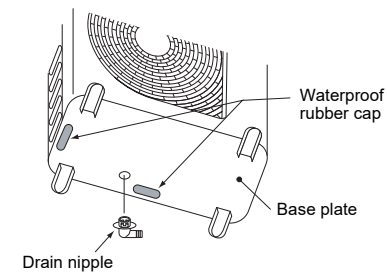
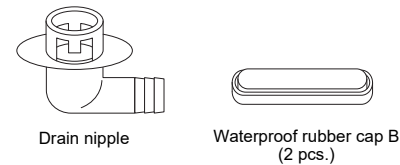

For reference

If a heating operation is to be continuously performed for a long time under the condition that the outdoor temperature is 0 °C or lower, draining defrosted water may be difficult due to the bottom plate, drain nipple and drain hose freezing, resulting in trouble with the cabinet or fan.

It is recommended to procure an anti-freeze heater locally in order to safely install the air to water heat pump.

For details, contact the dealer.

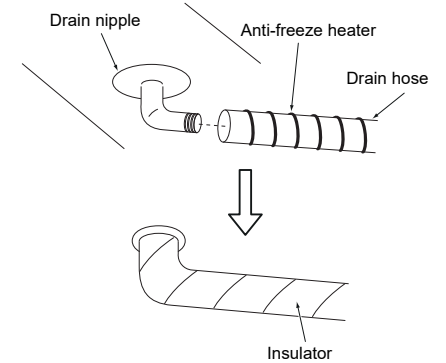

- * (HWT-80*HRW-E, HWT-110*HRW-E) are not eligible.

5 Refrigerant piping

■ Refrigerant Piping

- Use the following items for the refrigerant piping.
Material : Seamless phosphorous deoxidized copper pipe.
 $\phi 6.35$, $\phi 9.52$, $\phi 12.7$ Wall thickness 0.8 mm or more
 $\phi 15.88$ Wall thickness 1.0 mm or more
Do not use any copper pipes with a wall thickness less than these thicknesses.

Removing service panel

- Remove the screws at 3 locations and slide the service panel down. Next, detach the right-side claws followed by left-side claws to remove the service panel.
- When doing this, pulling the service panel towards the front could damage the claws.
- When attaching the service panel, attach the left claws followed by the right claws and lift the service panel upwards and secure it with screws in the 3 locations.

<HWT-80, 110>

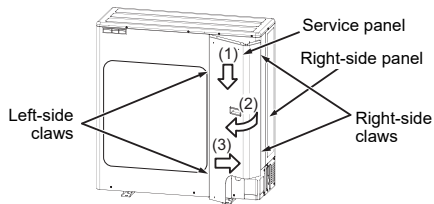

■ Knockout of Pipe Cover

Knockout procedure

<HWT-80, 110>

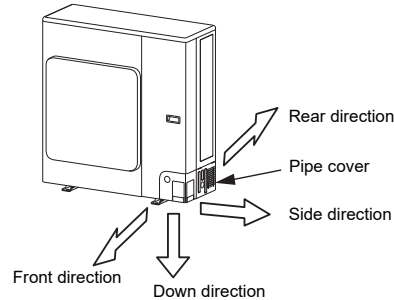

- The hydro/outdoor connecting pipes can be connected in 4 directions.
 Take off the knockout part of the pipe cover through which pipes or wires will pass through the base plate.
- Detach the pipe cover and tap on the knockout section a few times with the shank of a screwdriver. A knockout hole can easily be punched.
- After punching out the knockout hole, remove burrs from the hole and then install the supplied protective bush and guard material around the passage hole to protect wires and pipes.
 Be sure to attach the pipe covers after pipes have been connected. Cut the slits under the pipe covers to facilitate the installation.
 After connecting the pipes, be sure to mount the pipe cover. The pipe cover is easily mounted by cutting off the slit at the lower part of the pipe cover.



* Be sure to wear heavy work gloves while working.

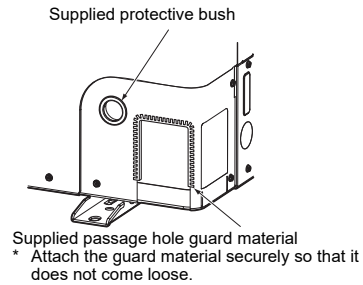

■ Optional Installation Parts (Locally procured)

<HWT-80, 110>

	Parts name	Q'ty
A	Refrigerant piping Liquid side: $\phi 6.4$ mm Gas side: $\phi 15.9$ mm	One each
B	Pipe insulating material (polyethylene foam, 10 mm thick)	1
C	Putty, PVC tape	One each

<HWT-40, 60>

	Parts name	Q'ty
A	Refrigerant piping Liquid side: $\phi 6.4$ mm Gas side: $\phi 12.7$ mm	One each
B	Pipe insulating material (polyethylene foam, 6 mm thick)	1
C	Putty, PVC tape	One each

■ Refrigerant Piping Connection

⚠ CAUTION

- Take note of these 4 important points below for piping work
- Keep dust and moisture away from inside the connecting pipes.
 - Tightly connect the connection between pipes and the unit.
 - Evacuate the air in the connecting pipes using a VACUUM PUMP.
 - Check for gas leaks at connection points.

Piping connection

Liquid side	
Outer diameter	Thickness
6.4 mm	0.8 mm

Gas side	
Outer diameter	Thickness
12.7 mm	0.8 mm
15.9 mm	1.0 mm

Flaring

- Cut the pipe with a pipe cutter.
 Be sure to remove burrs that may cause a gas leak.
- Insert a flare nut into the pipe, and then flare the pipe.
 Use the flare nuts supplied with the Air to Water Heat Pump or those for R32.
 Insert a flare nut into the pipe, and flare the pipe.
 Use the flare nuts supplied with the Air to Water Heat Pump or flare nuts for R32 or R410A.
 However, the conventional tools can be used by adjusting the projection margin of the copper pipe.

Projection margin in flaring: B (Unit: mm)

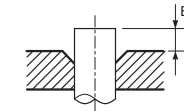

Rigid (Clutch type)

Outer dia. of copper pipe	R32 or R410A tool used	Conventional tool used
6.4	0 to 0.5	1.0 to 1.5
12.7		
15.9		

Flaring diameter size: A (Unit: mm)



Outer dia. of copper pipe	A ⁺⁰ _{-0.4}
6.4	9.1
12.7	16.6
15.9	19.7

CAUTION

- Do not scratch the inner surface of the flared part when removing burrs.
- Flare processing under the condition of scratches on the inner surface of flare processing part will cause refrigerant gas leak.
- Check that the flared part is not scratched, deformed, stepped, or flattened, and that there are no chips adhered or other problems, after flare processing.
- Do not apply refrigerating machine oil to the flare surface.

■ Tightening of Connecting Part

1. Align the centers of the connecting pipes and fully tighten the flare nut with your fingers. Then fix the nut with a wrench as shown in the figure and tighten it with a torque wrench.
2. As shown in the figure, be sure to use two wrenches to loosen or tighten the flare nut of the valve on the gas side. If you use a single crescent, the flare nut cannot be tightened to the required tightening torque. On the other hand, use a single crescent to loosen or tighten the flare nut of the valve on the liquid side.

(Unit: N•m)

Outer dia. of copper pipe	Tightening torque
6.4 mm	14 to 18
12.7 mm	50 to 62
15.9 mm	68 to 82

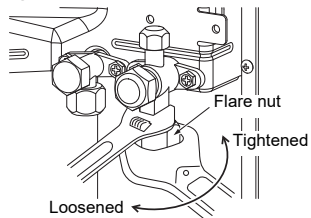
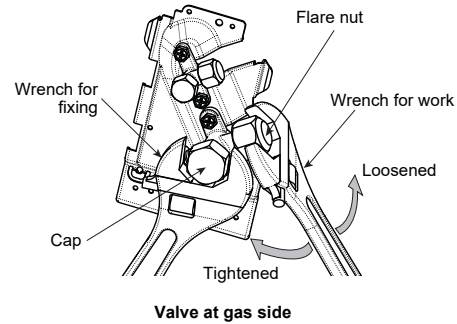
**<HWT-80, 110>
Valve at gas side****<HWT-40, 60>****CAUTION**

- Do not put the crescent wrench on the cap. The valve may break.
- If applying excessive torque, the nut may break according to some installation conditions.

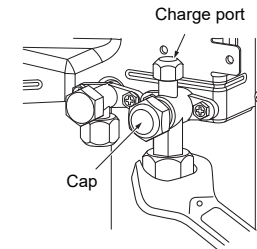
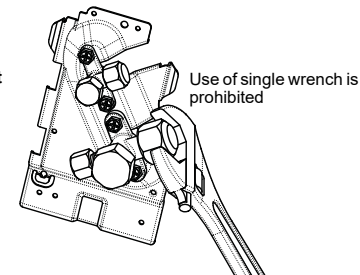
**Incorrect****Incorrect**

- After the installation work, be sure to check for gas leaks of the pipe connections with nitrogen. Therefore, using a torque wrench, tighten the flare pipe connecting sections that connect the hydro/ Outdoor Units at the specified tightening torque. Incomplete connections may cause not only a gas leak, but also trouble with the refrigeration cycle.

Do not apply refrigerant machine oil to the flared surface.

■ Refrigerant pipe length

Refrigeration pipe
 H: max. ±30 m (above / below)
 L: max. 30 m, min 5 m

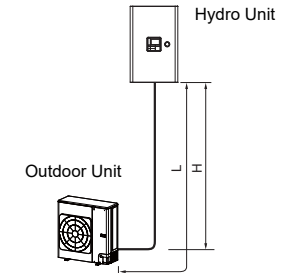

6 Air purging

■ Airtight test

After completing the refrigerant piping work, perform an airtight test. Connect a nitrogen gas cylinder and pressurize the pipes with nitrogen gas as follows to conduct the airtight test.

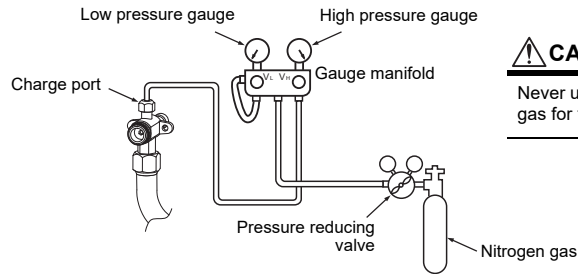

⚠ CAUTION

Never use oxygen, flammable gas, or noxious gas for the airtight test.

Gas leak check

Step 1....Pressurize to **0.5 MPa** (5 kg/cm²G) for 5 minutes or longer. > Major leaks can be discovered.

Step 2....Pressurize to **1.5 MPa** (15 kg/cm²G) for 5 minutes or longer. > Major leaks can be discovered.

Step 3....Pressurize to **4.15 MPa** (42 kg/cm²G) <HWT-40, 60 model> for 24 hours. > Micro leaks can be discovered.
Pressurize to **4.6 MPa** (46 kg/cm²G) <HWT-80, 110 model> for 24 hours. > Micro leaks can be discovered.

(However, note that when the ambient temperature differs during pressurization and after 24 hours, the pressure will change by approximately 0.01 MPa (0.1 kg/cm²G) per 1°C, so this should be compensated.)

If the pressure drops in steps 1 through 3, check the connections for leakage. Check for leaks with foaming liquid, etc., take steps to fix the leaks such as brazing the pipes again and tightening the flare nuts, and then perform the airtight test again.

* After the airtight test is completed, evacuate the nitrogen gas.

■ Air purge

With respect to the preservation of the terrestrial environment, adopt "Vacuum pump" to purge air (Evacuate air in the connecting pipes) when installing the unit.

- Do not discharge the refrigerant gas to the atmosphere to preserve the terrestrial environment.
- Use a vacuum pump to discharge the air (nitrogen, etc.) that remains in the set. If air remains, the capacity may decrease.

For the vacuum pump, be sure to use one with a backflow preventer so that the oil in the pump does not backflow into the pipe of the Air to Water Heat Pump when the pump stops.

(If oil in the vacuum pump is put in an Air to Water Heat Pump including R32, it may cause trouble with the refrigeration cycle.)

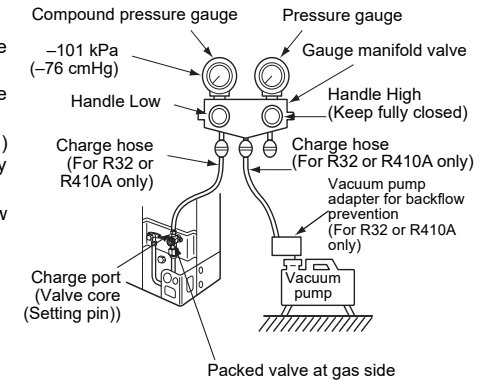

Vacuum pump

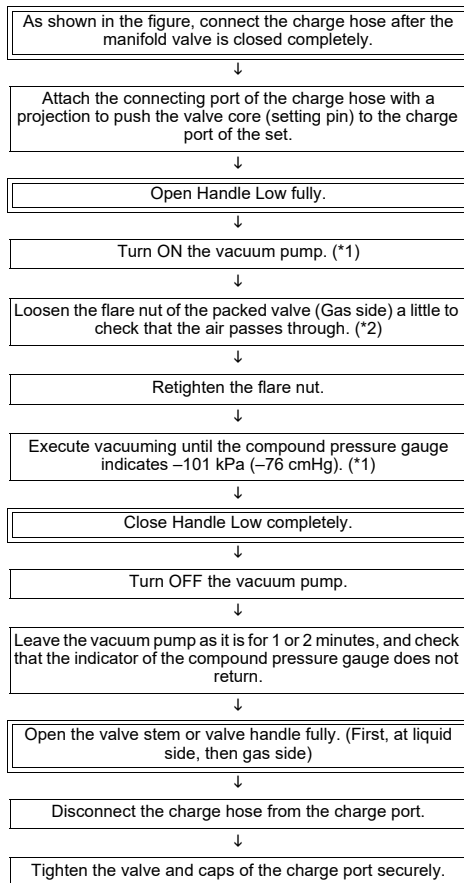

*1 Use the vacuum pump, vacuum pump adapter, and gauge manifold correctly referring to the manuals supplied with each tool before using them. Check that the vacuum pump oil is filled up to the specified line of the oil gauge.

*2 When air is not charged, check again whether the connecting port of the discharge hose, which has a projection to push the valve core, is firmly connected to the charge port.

How to Open the Valve

Fully open the valves of the Outdoor Unit. (First fully open the valve on the liquid side, and then fully open the valve on the gas side.)

* Do not open or close the valves when the ambient temperature is -20°C or less. Doing so may damage the valve O-rings and result in refrigerant leakage.

Liquid side

Open the valve with hexagon wrench.

Model HWT-	Hexagon wrench size
40 60	4 mm
80 110	

Gas side

<HWT-80, 110>

Service valve

Open the valve with hexagon wrench.
Hexagon wrench size : 5 mm

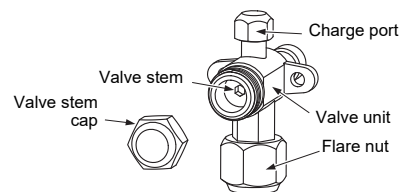

<HWT-40, 60>

Service valve

Open the valve with hexagon wrench.
Hexagon wrench size : 4 mm

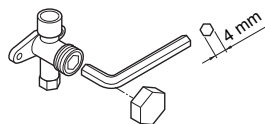

Cap tightening torque

Cap tightening torque		
Valve size	Ø6.4 mm	14 to 18 N·m (1.4 to 1.8 kgf·m)
	Ø12.7 mm	33 to 42 N·m (3.3 to 4.2 kgf·m)
	Ø15.9 mm	33 to 42 N·m (3.3 to 4.2 kgf·m)
Charge port		14 to 18 N·m (1.4 to 1.8 kgf·m)

Replenishing Refrigerant

This model is a 8 m* chargeless type that does not need to have its refrigerant replenished for refrigerant pipes up to 8 m*. When a refrigerant pipe longer than 8 m* is used, add the specified amount of refrigerant.

* HWT-40, 60: 15m

Refrigerant replenishing procedure

- After vacuuming the refrigerant pipe, close the valves and then charge the refrigerant while the Air to Water Heat Pump is not working.
- When the refrigerant cannot be charged to the specified amount, charge the required amount of refrigerant from the charge port of the valve on the gas side during cooling.

- Ensure that contamination of different refrigerants does not occur when using charging equipment. Hoses or lines shall be as short as possible to minimise the amount of refrigerant contained in them.
- Cylinders shall be kept in an appropriate position according to the instructions.
- Ensure that the refrigerating system is earthed prior to charging the system with refrigerant.
- Label the system when charging is complete (if not already).
- Extreme care shall be taken not to overfill the refrigerating system.
- Prior to recharging the system, it shall be pressure-tested with the appropriate purging gas.
- The system shall be leak-tested on completion of charging but prior to commissioning. A follow up leak test shall be carried out prior to leaving the site.

Requirement for replenishing refrigerant

Replenish liquid refrigerant.

When gaseous refrigerant is replenished, the refrigerant composition varies, which disables normal operation.

Adding additional refrigerant

Model HWT-	Pipe length: L	Adding additional refrigerant
40 60	20~30 m: L	20 g × (L-20)
80 110	8~30 m: L	25 g × (L-8)

* The maximum refrigerant charge: 1.8kg

<HWT-40, 60>

The refrigerant need not be reduced for a 15 meter (or less) refrigerant pipe.

<HWT-80, 110>

- The refrigerant need not be reduced for a 8 meter (or less) refrigerant pipe.

Gas leak inspection

Use a leak detector manufactured specially for HFC refrigerant (R32, R410A, R134a, etc.) to perform the R32 gas leak inspection.

- Leak detectors for conventional HCFC refrigerant (R22, etc.) cannot be used, as the sensitivity drops to approximately 1/40 when used for HFC refrigerant.**
- R32 has a high working pressure, so failure to perform the installation work properly may result in gas leaks such as when the pressure rises during operation. Be sure to perform leak tests on the piping connections.
- Under no circumstances shall potential sources of ignition be used in the searching for or detection of refrigerant leaks. A halide torch (or any other detector using a naked flame) shall not be used.
- Electronic leak detectors may be used to detect refrigerant leaks but, in the case of flammable refrigerants, the sensitivity may not be adequate, or may need re-calibration.
- Ensure that the detector is not a potential source of ignition and is suitable for the refrigerant used. Leak detection equipment shall be set at a percentage of the LFL of the refrigerant and shall be calibrated to the refrigerant employed, and the appropriate percentage of gas (25 % maximum) is confirmed.
- Leak detection fluids are also suitable for use with most refrigerants but the use of detergents containing chlorine shall be avoided as the chlorine may react with the refrigerant and corrode the copper pipe-work.
- If a leak is suspected, all naked flames shall be removed/extinguished.
- If a leakage of refrigerant is found which requires brazing, all of the refrigerant shall be recovered from the system, or isolated (by means of shut off valves) in a part of the system remote from the leak.

Hydro Unit inspection locations
(piping connections)

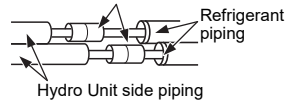

<HWT-80, 110>

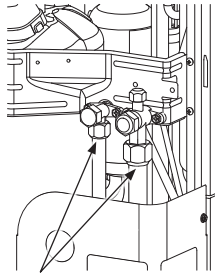

Outdoor Unit inspection locations

<HWT-40, 60>

Outdoor Unit inspection locations

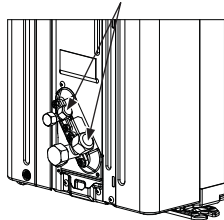

■ Insulating the Pipes

- The temperatures at both the liquid side and gas side will be low during cooling so in order to prevent condensation, be sure to insulate the pipes at both of these sides.
- Insulate the pipes separately for the liquid side and gas side.

REQUIREMENT

Be sure to use an insulating material which can withstand temperatures above 120°C for the gas side pipe since this pipe will become very hot during heating operations.

■ To Fix the Fluorinated Greenhouse Gases Label

This product contains fluorinated greenhouse gases. Do not vent gases into the atmosphere.

Contains fluorinated greenhouse gases	
• Chemical Name of Gas	R32
• Global Warming Potential (GWP) of Gas	675

⚠ CAUTION

1. Stick the enclosed refrigerant label adjacent to the service ports for charging or recovering location and where possible adjacent to existing nameplates or product information label.
2. Clearly write the charged refrigerant quantity on the refrigerant label using indelible ink. Then, place the included transparent protective sheet over the label to prevent the writing from rubbing off.
3. Prevent emission of the contained fluorinated greenhouse gas. Ensure that the fluorinated greenhouse gas is never vented to the atmosphere during installation, service or disposal. When any leakage of the contained fluorinated greenhouse gas is detected, the leak shall be stopped and repaired as soon as possible.
4. Only qualified service personnel are allowed to access and service this product.
5. Any handling of the fluorinated greenhouse gas in this product, such as when moving the product or recharging the gas, shall comply under (EU) Regulation No. 517/2014 on certain fluorinated greenhouse gases and any relevant local legislation.
6. Periodical inspections for refrigerant leaks may be required depending on European or local legislation.
7. Contact dealers, installers, etc., for any questions.

Fill in the label as follows:

Refrigerant Label

Contains fluorinated greenhouse gases.

① Pre-charged refrigerant at factory [kg], specified in the nameplate.

② Additional charge on installation site [kg].

③ Total quantity of refrigerant in tonnes CO₂ equivalent.

Caution: Write out charge amount ①, ②, ①+② and ③ by indelible means on installation site.

R32 GWP:675

① = kg

② = kg

①+② = kg

③ = t

$\frac{\text{GWP} \times \text{kg}}{1000}$

Model HWT-	Pre-charged refrigerant
40 60	0.9 kg
80 110	1.25 kg

7 Electrical work

⚠ WARNING

1. **Using the specified wires, ensure that the wires are connected, and fix wires securely so that the external tension to the wires does not affect the connecting part of the terminals.**
Incomplete connection or fixation may cause a fire, etc.
2. **Be sure to connect the earth wire. (Grounding work)**
Incomplete earthing may lead to electric shock.
Do not connect earth wires to gas pipes, water pipes, lightning rods or earth wires for telephone wires.
3. **The appliance shall be installed in accordance with national wiring regulations.**
Capacity shortages of the power circuit or an incomplete installation may cause an electric shock or fire.

⚠ CAUTION

- An installation fuse must be used for the power supply line of this Air to Water Heat Pump.
- Incorrect / incomplete wiring may lead to an electrical fire or smoke.
- Prepare an exclusive power supply for the Air to Water Heat Pump.
- This product can be connected to the mains power. Fixed wire connections:
A switch that disconnects all poles and has a contact separation of at least 3 mm must be incorporated in the fixed wiring.
- Be sure to use the cord clamps attached to the product.
- Do not damage or scratch the conductive core or inner insulator of the power and hydro/outdoor connecting wires when peeling them.
- Use the power and hydro/outdoor connecting wires with specified thicknesses, specified types and protective devices required.
- Check that cabling will not be subject to wear, corrosion, excessive pressure, vibration, sharp edges or any other adverse environmental effects. The check shall also take into account the effects of aging or continual vibration from sources such as compressors or fans.

<HWT-40, 60>

1. Remove valve cover screw.
2. Pull the valve cover downward to remove it.

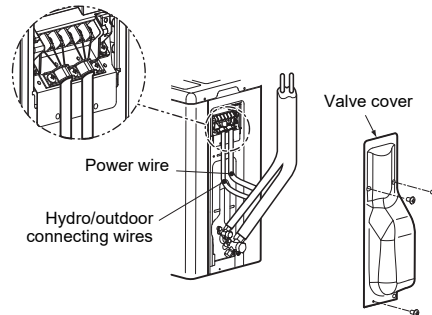

<HWT-80, 110>

1. Remove the service panel, and the terminal cover.
2. A conduit pipe can be installed through the hole for wiring. If the hole size does not fit the wiring pipe to be used, drill the hole again to an appropriate size.
3. Be sure to clamp the power wires and hydro/outdoor connecting wires with a cord clamp along the connecting pipe so that the wires do not touch the compressor or discharge pipe. (The compressor and the discharge pipe become hot.)

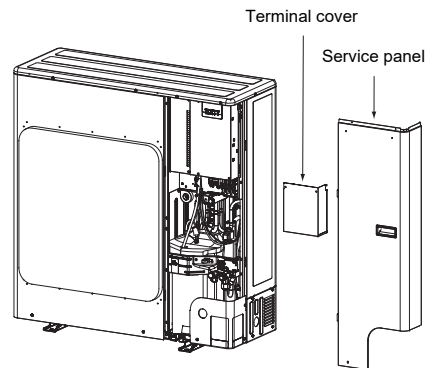

■ Wiring between Hydro Unit and Outdoor Unit

The dashed lines show on-site wiring.

Connect the system interconnection wires to the identical terminal numbers on the terminal block of each unit. Incorrect connection may cause a failure.

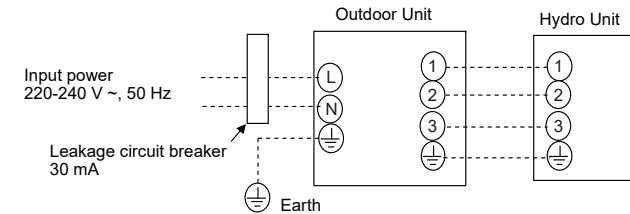

For the Air to Water Heat Pump, connect a power wire with the following specifications.

Model	HWT-40	HWT-60	HWT-80	HWT-110
Power supply	220-240 V ~ 50 Hz			
Maximum running current	14.6 A		20.3 A	
Recommended field fuse	16 A		25 A	
Power supply wire*	2 × 2.5 mm ² or more (H07 RN-F or 60245 IEC 66)			
Outdoor earth wire	1 × 2.5 mm ² or more			
Hydro / Outdoor connecting wires*	4 × 1.5 mm ² or more (H07 RN-F or 60245 IEC 66)			

* Number of wire × wire size

How to wire

1. Connect the system interconnection wire to the terminal as identified with their respective numbers on the terminal block of the Hydro and Outdoor Units.
H07 RN-F or 60245 IEC 66 (1.5 mm² or more)
2. When connecting the system interconnection wire to the Outdoor Unit terminal, prevent water from coming into the Outdoor Unit.
3. Insulate the unsheathed cords (conductors) with electrical insulation tape. Process them so that they do not touch any electrical or metal parts.
4. For interconnecting wires, do not use a wire joined to another on the way.
Use wires long enough to cover the entire length.
5. Fix power supply wire and system interconnection wire.

<HWT-40, 60>

- Be sure to use the cord clamps attached to the product.

<HWT-80, 110>

- Fix to pipe valve fixing plate using cable tie. Measure diameter of fixed wire. Excess length should be satisfy following fomula. (Use T50R-HSW manufactured by HellermannTyton)

$$A = 183 - 3.14 \times L$$

A: Excessive length of cable-tie
 L: Circumference of the wire (mm)
 L = Diameter of the wire D (mm) × π

- Cut cable tie of excessive part (A).

CAUTION

- An installation fuse must be used for the power supply line of this Air to Water Heat Pump.
- Incorrect / incomplete wiring may lead to an electrical fire or smoke.
- Prepare a dedicated power supply for the Air to Water Heat Pump.
- This product can be connected to the mains power. Fixed wire connections:
 A switch that disconnects all poles and has a contact separation of at least 3 mm must be incorporated in the fixed wiring.

<HWT-80, 110>

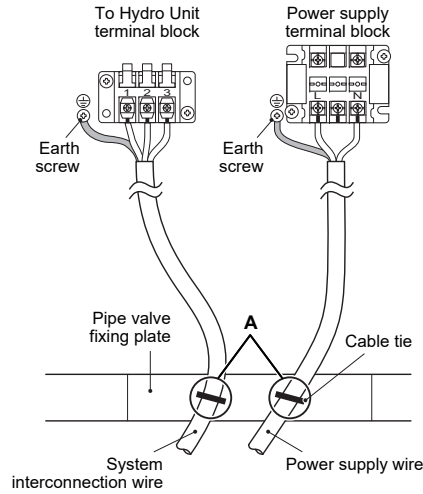

Details of A

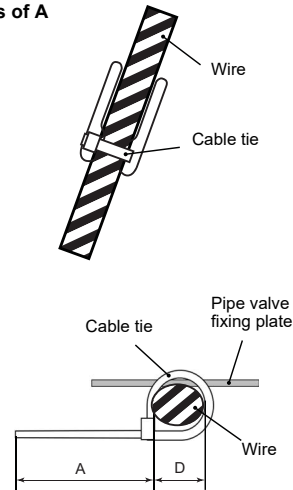

Stripping length power supply wire and system interconnection wire

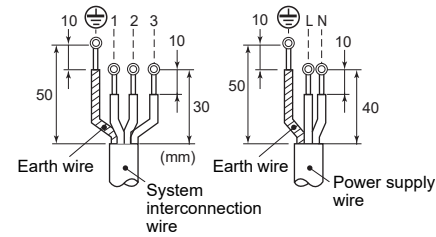

<HWT-40, 60>

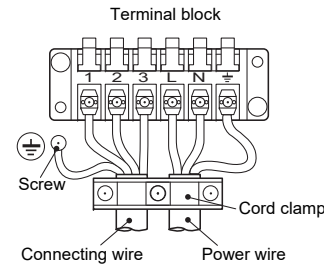

Stripping length power cord and connecting wire

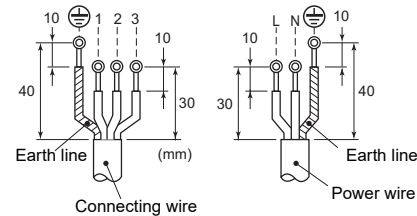

8 Earthing

WARNING

Be sure to connect the earth wire. (Grounding work)
Incomplete earthing may cause an electric shock.

Connect the earth wire properly following applicable technical standards.

Connecting the earth wire is essential to preventing electric shock and to reducing noise and electrical charges on the Outdoor Unit surface due to the high-frequency wave generated by the frequency converter (inverter) in the Outdoor Unit.

If you touch the charged Outdoor Unit without an earth wire, you may experience an electric shock.

9 Finishing

After the refrigerant pipe, Hydro / Outdoor connecting wires have been connected, cover them with finishing tape and clamp them to the wall with off-the-shelf support brackets or their equivalent.

Keep the power wires and Hydro / Outdoor connecting wires off the valve on the gas side or pipes that have no heat insulator.

10 Test run

- Turn on the leakage circuit breaker at least 12 hours before starting a test run to protect the compressor during startup.
- Check the following before starting a test run:
 - **That all pipes are connected securely without leaks.**
 - **That the valve is open.**
If the compressor is operated with the valve closed, the Outdoor Unit will become overpressurized, which may damage the compressor or other components.
If there is a leak at a connection, air can be sucked in and the internal pressure further increases, which may cause a burst or injury.
- Operate the Air to Water Heat Pump in the correct procedure as specified in the Owner's Manual.

Please refer to the Hydro Unit installation manual for the detail of the test run.

11 Annual maintenance

- For an Air to Water Heat Pump system that is operated on a regular basis, cleaning and maintenance of the Hydro / Outdoor Units are strongly recommended.

As a general rule, if an Hydro Unit is operated for about 8 hours daily, the Hydro / Outdoor Units will need to be cleaned at least once every 3 months. This cleaning and maintenance should be carried out by a qualified service person.

Failure to clean the Hydro / Outdoor Units regularly will result in poor performance, icing, water leaking and even compressor failure.

12 Air to Water Heat Pump operating conditions

For proper performance, operate the Air to Water Heat Pump under the following temperature conditions:

<HWT-40, 60>

Cooling operation	10 °C to 43 °C
Heating operation	-20 °C to 25 °C
Hot water operation	-20 °C to 43 °C

<HWT-80, 110>

Cooling operation	10 °C to 43 °C
Heating operation	-25 °C to 25 °C
Hot water operation	-25 °C to 43 °C

If Air to Water Heat Pump is used outside of the above conditions, safety protection may work.

13 Functions to be implemented locally

■ Handling existing pipe

When using the existing pipe, carefully check for the following:

- Wall thickness (within the specified range)
- Scratches and dents
- Water, oil, dirt, or dust in the pipe
- Flare looseness and leakage from welds
- Deterioration of copper pipe and heat insulator

Cautions for using existing pipe

- Do not reuse a flare nut to prevent gas leaks.
Replace it with the supplied flare nut and then process it to a flare.
- Blow nitrogen gas or use an appropriate means to keep the inside of the pipe clean. If discolored oil or much residue is discharged, wash the pipe.
- Check welds, if any, on the pipe for gas leaks.

When the pipe corresponds to any of the following, do not use it. Install a new pipe instead.

- The pipe has been opened (disconnected from Hydro Unit or Outdoor Unit) for a long period.
- The pipe has been connected to an Outdoor Unit that does not use refrigerant R22, R410A or R407C.
- The existing pipe must have a wall thickness equal to or larger than the following thicknesses.

Reference outside diameter (mm)	Wall thickness (mm)
Ø6.4	0.8
Ø12.7	0.8
Ø15.9	1.0

- Do not use any pipe with a wall thickness less than these thicknesses due to insufficient pressure capacity.

Refrigerant Recovery

When recovering the refrigerant in situations such as when relocating an Hydro Unit or Outdoor Unit, the recovery operation can be performed by operating the SW01 and SW02 switches on the P.C. board of the Outdoor Unit.

A cover for the electric parts has been installed in order to provide protection from electric shocks while work is being performed. Operate the service switches and check the LED displays with this electric parts cover in place. Do not remove this cover while the power is still on.

⚠ DANGER

The entire P.C. board of this Air to Water Heat Pump system is a high-voltage area. When operating the service switches with the power of the system left on, wear electrically insulated gloves.

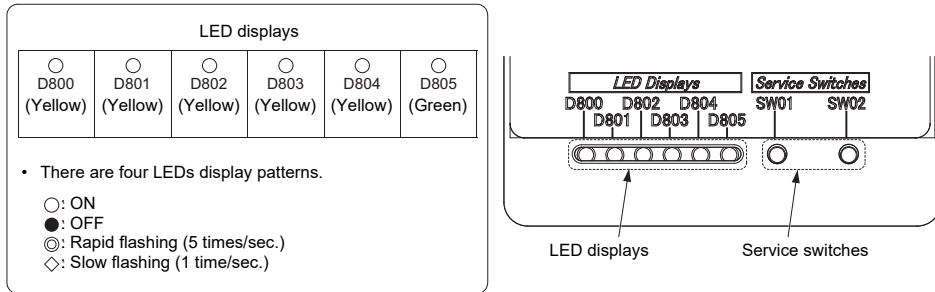

* In the initial LED display status, D805 is lighted as shown on the table below. If the initial status is not established (if D805 is flashing), hold down the SW01 and SW02 service switches simultaneously for at least 5 seconds to return the LED displays to the initial status.

LED display initial status

D800 (Yellow)	D801 (Yellow)	D802 (Yellow)	D803 (Yellow)	D804 (Yellow)	D805 (Green)
● or ⊙	● or ⊙	● or ⊙	● or ⊙	● or ⊙	○
OFF or Rapid flashing	OFF or Rapid flashing	OFF or Rapid flashing	OFF or Rapid flashing	OFF or Rapid flashing	ON

* In order to reduce standby power, the LED indication may be turned off even when the power is on. When either SW01 or SW02 is pressed, the LED is displayed.

Steps taken to recover the refrigerant

- Operate the Hydro Unit in the pump mode.
- Check that the LED displays are placed in their initial status. If not, place them in the initial status.
- Hold down SW01 for at least 5 seconds, and check that D804 flashes slowly. (Fig. 1)
- Press SW01 once to set the LED displays (D800 to D805) to the "refrigerant recovery LED display" shown below. (Fig. 2)

(Fig. 1)

LED displays indicated when step 3 is taken					
D800	D801	D802	D803	D804	D805
○	●	●	●	◇	●

○: ON, ●: OFF, ◇: Slow flashing

(Fig. 2)

Refrigerant recovery LED display					
D800	D801	D802	D803	D804	D805
○	●	●	●	⊙	●

○: ON, ●: OFF, ⊙: Rapid flashing

- Press SW02 to set D805 to rapid flashing. (Each time SW02 is pressed, D805 is switched between rapid flashing and OFF.) (Fig. 3)

- Hold down SW02 for at least 5 seconds, and when D804 flashes slowly and D805 lights, the forced cooling operation is started. (Max. 10 minutes) (Fig. 4)

(Fig. 3)

LED displays indicated when step 5 is taken					
D800	D801	D802	D803	D804	D805
○	●	●	●	⊙	⊙

○: ON, ●: OFF, ⊙: Rapid flashing

(Fig. 4)

LED displays indicated when step 6 is taken					
D800	D801	D802	D803	D804	D805
○	●	●	●	◇	○

○: ON, ●: OFF, ◇: Slow flashing

- After operating the system for at least 3 minutes, close the valve on the liquid side.
 - After the refrigerant has been recovered, close the valve on the gas side.
 - Hold down SW01 and SW02 simultaneously for at least 5 seconds. The LED displays are returned to the initial status, and the cooling operation stop.
 - Turn off the power.
- * If there is any reason to doubt whether the recovery was successful in the course of this operation, hold down SW01 and SW02 simultaneously for at least 5 seconds to return to the initial status, and then repeat the steps for recovering the refrigerant.

14 Troubleshooting

You can perform fault diagnosis of the Outdoor Unit with the LEDs on the P.C. board of the Outdoor Unit in addition to using the check codes displayed on the wired remote controller of the Hydro Unit.

Use the LEDs and check codes for various checks. Details of the check codes displayed on the wired remote controller of the Hydro Unit are described in the Installation Manual of the Hydro Unit.

LED Displays and Check Codes

○: ON, ●: OFF, ⊙: Rapid flashing (5 times/sec)

No.	Trouble description	LED display					
		D800	D801	D802	D803	D804	D805
1	Normal	●	●	●	●	●	○
2	Discharge temp. sensor (TD) trouble	⊙	●	●	●	●	○
3	Heat exchanger temp. sensor (TE) trouble	●	⊙	●	●	●	○
4	Heat exchanger temp. sensor (TL) trouble	⊙	⊙	●	●	●	○
5	Outside air temp. sensor (TO) trouble	●	●	⊙	●	●	○
6	Suction temp. sensor (TS) trouble	⊙	●	⊙	●	●	○
7	Heat sink temp. sensor (TH) trouble	●	⊙	⊙	●	●	○
8	Miss-mounting of sensor (TE, TS)	⊙	⊙	⊙	●	●	○
9	EEPROM trouble	●	⊙	●	⊙	●	○
10	Compressor break down	⊙	⊙	⊙	⊙	●	○
11	Compressor lock	●	●	●	●	●	○
12	Current detection circuit trouble	⊙	●	⊙	⊙	●	○
13	Case thermostat operation	●	⊙	⊙	⊙	●	○
14	Unset model type of P.C.board	●	●	●	●	⊙	○
15	MCU communication trouble	⊙	●	●	●	⊙	○
16	Discharge temp. trouble	●	⊙	●	●	⊙	○
17	High pressure SW operation	⊙	⊙	●	●	⊙	○
18	Power supply trouble	●	●	⊙	●	⊙	○
19	Heat sink overheat trouble	●	⊙	⊙	●	⊙	○
20	Gas leak detection	⊙	⊙	⊙	●	⊙	○
21	4-way valve inverse trouble	●	●	●	⊙	⊙	○
22	High pressure protective operation	⊙	●	●	⊙	⊙	○
23	Fan system trouble	●	⊙	●	⊙	⊙	○
24	Short-circuit of compressor drive element	⊙	⊙	●	⊙	⊙	○
25	Position detection circuit trouble	●	●	⊙	⊙	⊙	○
26	High pressure sensor (Pd) trouble	⊙	●	●	⊙	●	○
27	Combination failure between the Hydro Unit	⊙	⊙	⊙	⊙	⊙	○

<HWT-80, 110>

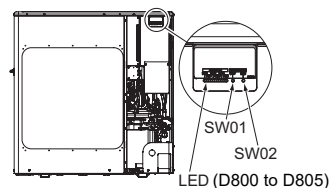

<HWT-40, 60>

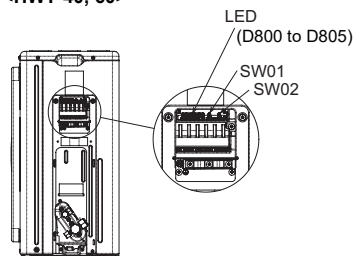

15 Appendix

Existing piping

Work instructions

The existing R22 and R407C piping can be reused for our digital inverter R32 product installations.

WARNING

Confirming the existence of scratches or dents on the existing pipes and confirming the reliability of the pipe strength are conventionally referred to the local site.
If the specified conditions can be cleared, it is possible to update existing R22 and R407C pipes to those for R32 models.

Basic conditions needed to reuse existing pipes

Check and observe the presence of three conditions in the refrigerant piping works.

1. **Dry** (There is no moisture inside of the pipes.)
2. **Clean** (There is no dust inside of the pipes.)
3. **Tight** (There are no refrigerant leaks.)

Restrictions for use of existing pipes

In the following cases, the existing pipes should not be reused as they are. Clean the existing pipes or exchange them with new pipes.

1. When a scratch or dent is heavy, be sure to use new pipes for the refrigerant piping works.
2. When the existing pipe thickness is thinner than the specified "Pipe diameter and thickness," be sure to use new pipes for the refrigerant piping works.
 - The operating pressure of R32 is high. If there is a scratch or dent on the pipe or a thinner pipe is used, the pressure strength may be inadequate, which may cause the pipe to break in the worst case.

* Pipe diameter and thickness (mm)

Reference outside diameter (mm)	Wall thickness (mm)	Material
Φ6.4	0.8	-
Φ12.7	0.8	-
Φ15.9	1.0	-

- In case the pipe diameter is Φ12.7 mm or less and the thickness is less than 0.7 mm, be sure to use new pipes for the refrigerant piping works.

3. When the Outdoor Unit was left with the pipes disconnected, or the gas leaked from the pipes and the pipes were not repaired and refilled.
 - There is the possibility of rain water or air, including moisture, entering the pipe.
4. When refrigerant cannot be recovered using a refrigerant recovery unit.
 - There is the possibility that a large quantity of dirty oil or moisture remains inside the pipes.
5. When a commercially available dryer is attached to the existing pipes.
 - There is the possibility that copper green rust has been generated.
6. When the existing Air to Water Heat Pump is removed after refrigerant has been recovered. Check if the oil is judged to be clearly different from normal oil.
 - The refrigerator oil is copper rust green in color: There is the possibility that moisture has mixed with the oil and rust has been generated inside the pipe.
 - There is discolored oil, a large quantity of residue, or a bad smell.
 - A large quantity of shiny metal dust or other wear residue can be seen in the refrigerant oil.
7. When the Air to Water Heat Pump has a history of the compressor failing and being replaced.
 - When discolored oil, a large quantity of residue, shiny metal dust, or other wear residue or mixture of foreign matter is observed, trouble will occur.
8. When temporary installation and removal of the Air to Water Heat Pump are repeated such as when leased, etc.
9. If the type of refrigerator oil of the existing Air to Water Heat Pump is other than the following oil (Mineral oil), Suniso, Freol-S, MS (Synthetic oil), alkyl benzene (HAB, Barrel-freeze), ester series, PVE only of other series.
 - The winding-insulation of the compressor may deteriorate.

NOTE

The above descriptions are results have been confirmed by our company and represent our views on our Air to Water Heat Pump, but do not guarantee the use of the existing pipes of Air to Water Heat Pump that have adopted R32 or R410A in other companies.

Curing of pipes

When removing and opening the Hydro or Outdoor Unit for a long time, cure the pipes as follows:

- Otherwise rust may be generated when moisture or foreign matter due to condensation enters the pipes.
- The rust cannot be removed by cleaning, and new pipes are necessary.

Placement location	Term	Curing manner
Outdoors	1 month or more	Pinching
	Less than 1 month	Pinching or taping
Indoors	Every time	

Toshiba Carrier Air-Conditioning Europe Sp.z o.o.

ul. Gdańska 131, 62-200 Gniezno, Poland

2F30251001