

**DAIKIN**



# INSTALLATION AND OPERATION MANUAL

**VRV IV** System indoor unit

HXY080A8V1B  
HXY125A8V1B



**Content**

	Page		Page
1. About the documentation .....	2	9. Installing the optional EKBUHAA(6V3/6W1) heater kit .....	26
1.1. About this document .....	2	10. Hand-over to the user .....	26
1.2. Scope of the manual .....	2	11. Operation of the unit .....	27
1.3. Documentation set .....	2	11.1. Introduction .....	27
2. General safety precautions .....	2	11.1.1. General information .....	27
2.1. For the user .....	2	11.2. Quick start-up of the unit .....	27
2.2. For the installer .....	2	11.2.1. Space cooling/heating operation .....	27
2.2.1. General .....	2	11.3. Operating the unit .....	27
2.2.2. Installation site .....	3	11.3.1. Operating the user interface .....	27
2.2.3. Refrigerant .....	3	11.3.2. Name and function of buttons and icons .....	28
2.2.4. Water .....	3	11.3.3. Setting up the controller .....	29
2.2.5. Electrical .....	3	11.3.4. Space cooling operation (*) .....	29
2.2.6. Meaning of used items .....	4	11.3.5. Space heating operation (*) .....	29
3. About the box .....	4	11.3.6. Other operation modes .....	31
3.1. Indoor unit .....	4	11.3.7. Temperature read-out mode .....	31
3.1.1. To unpack the indoor unit .....	4	11.3.8. Schedule timer operation .....	32
3.1.2. To remove the accessories from the indoor unit .....	4	11.3.9. Space heating .....	32
4. About the units and options .....	5	11.3.10. Programming and consulting the schedule timer .....	33
4.1. General information .....	5	11.3.11. Operating the optional demand PCB .....	37
4.1.1. Identification label: Indoor unit .....	5	11.3.12. Operating the optional user interface .....	37
4.2. Possible combinations of units and options .....	5	11.4. Field settings .....	37
4.2.1. List of options for indoor unit .....	5	11.4.1. Procedure .....	37
4.2.2. Possible combinations of indoor unit and outdoor unit .....	6	11.5. Field setting list for Operation Manual .....	38
5. Application guidelines .....	6	12. Maintenance .....	40
5.1. Overview: Application guidelines .....	6	12.1. Important information regarding the refrigerant used .....	40
5.2. Setting up the space heating/cooling system .....	6	12.2. Maintenance activities .....	40
5.3. Using an auxiliary heat source .....	7	13. Troubleshooting .....	40
6. Preparation .....	7	13.1. Malfunction codes list .....	40
6.1. Preparing installation site .....	7	14. Technical Data .....	40
6.1.1. Installation site requirements of the indoor unit .....	7	14.1. Piping diagram .....	40
6.2. Preparing water circuit .....	8	14.2. Wiring diagram .....	41
6.2.1. Selection of the type of heat emitters .....	8	14.3. Electrical components box .....	42
6.2.2. Water circuit requirements .....	9	14.4. Operation range HXY(080/125) .....	42
6.2.3. Formula to calculate the expansion vessel pre-pressure ...	9	14.5. ESP curve .....	42
6.2.4. To check the water volume .....	9	14.6. Technical specifications table .....	43
6.2.5. Changing the pre-pressure of the expansion vessel .....	10	14.7. Electrical specifications table .....	43
6.2.6. To check the water volume: Examples .....	10	15. Disposal requirements .....	43
6.3. Preparing electrical wiring .....	11		
6.3.1. About preparing electrical wiring .....	11		
6.3.2. Overview of electrical connections on the indoor unit .....	11		
7. Installation .....	12		
7.1. Mounting the indoor unit .....	12		
7.1.1. To install the indoor unit .....	12		
7.2. Connecting the water piping .....	13		
7.2.1. To connect the water piping .....	13		
7.3. Connecting the electrical wiring .....	14		
7.3.1. Precautions on electrical wiring work .....	14		
7.4. Finishing the indoor unit installation .....	16		
7.4.1. To fix the user interface cover to the indoor unit .....	16		
7.4.2. To close the indoor unit .....	16		
8. Commissioning .....	17		
8.2. Final air purging .....	17		
8.3. Field settings .....	17		
8.3.1. Procedure .....	17		
8.3.2. Detailed description .....	18		
8.4. Field setting list for Installation Manual .....	22		
8.5. Final check and test run .....	24		
8.5.1. Final check .....	24		
8.5.2. System test run .....	24		
8.5.3. Indoor unit individual test run .....	24		
8.6. Service and maintenance .....	25		
8.6.1. Maintenance activities .....	25		
8.6.2. Malfunction codes list .....	25		
8.6.3. Important information regarding the refrigerant used .....	25		

The English text is the original instruction. Other languages are translations of the original instructions.

# 1. About the documentation

## 1.1. About this document

This document is an installation manual. It is intended for authorized installers of this product. It describes the procedures for installing, commissioning and maintaining the unit, and it will provide help if problems occur. Carefully read the relevant parts of the manual.

This document is also an operation manual. It is intended for the installer and the user of this product. It describes how to operate and maintain the unit, and it will provide help if problems occur. Carefully read the relevant parts of the manual.

## 1.2. Scope of the manual

This manual does NOT include the selection procedure and the water system design procedure. Only some precautions and tips and tricks about the design of the water circuit are given in a separate chapter of this manual.

Once the selection is done and the water system is designed, this manual describes the procedures for handling, installing and connecting the HXY080/125 units. This manual has been prepared to ensure adequate maintenance of the unit, and it will provide help if problems occur.

## 1.3. Documentation set

This document is part of a documentation set. The complete set consists of:

Document	Contains...	Format
Indoor unit installation/operation manual	Installation and operator instructions	Indoor unit installation/operation manual
Outdoor unit installation manual	See info delivered with outdoor unit.	

Latest revisions of the supplied documentation may be available on the regional Daikin website or via your dealer.

# 2. General safety precautions

## 2.1. For the user

- If you are not sure how to operate the unit, contact your installer.
- The appliance is not intended for use by persons, including children, with reduced physical, sensory or mental capabilities, or lack of experience and knowledge, unless they have been given supervision or instruction concerning use of the appliance by a person responsible for their safety. Children must be supervised to ensure that they do not play with the product.



### CAUTION

Do NOT rinse the unit. This may cause electric shocks or fire.



### NOTICE

- Do NOT place any objects or equipment on top of the unit.
- Do NOT sit, climb or stand on the unit.

- Units are marked with the following symbol:



This means that electrical and electronic products may not be mixed with unsorted household waste. Do NOT try to dismantle the system yourself: the dismantling of the system, treatment of the refrigerant, of oil and of other parts must be done by an authorized installer and must comply with applicable legislation. Units must be treated at a specialized treatment facility for reuse, recycling and recovery. By ensuring this product is disposed of correctly, you will help to prevent potential negative consequences for the environment and human health. For more information, contact your installer or local authority.

## 2.2. For the installer

### 2.2.1. General

If you are not sure how to install or operate the unit, contact your dealer.



### NOTICE

Improper installation or attachment of equipment or accessories could result in electric shock, short-circuit, leaks, fire or other damage to the equipment. Only use accessories, optional equipment and spare parts made or approved by Daikin.



### WARNING

Make sure installation, testing and applied materials comply with applicable legislation (on top of the instructions described in the Daikin documentation).



### CAUTION

Wear adequate personal protective equipment (protective gloves, safety glasses,...) when installing, maintaining or servicing the system.



### DANGER: RISK OF BURNING

- Do NOT touch the refrigerant piping, water piping or internal parts during and immediately after operation. It could be too hot or too cold. Give it time to return to normal temperature. If you must touch it, wear protective gloves.
- Do NOT touch any accidental leaking refrigerant.

In accordance with the applicable legislation, it might be necessary to provide a logbook with the product containing at least: information on maintenance, repair work, results of tests, stand-by periods,...

Also, at least, following information must be provided at an accessible place at the product:

- Instructions for shutting down the system in case of an emergency.
- Name and address of fire department, police and hospital.
- Name, address and day and night telephone numbers for obtaining service.

In Europe, EN378 provides the necessary guidance for this logbook.

### 2.2.2. Installation site

- Provide sufficient space around the unit for servicing and air circulation.
- Make sure the installation site withstands the unit's weight and vibration.
- Make sure the area is well ventilated.
- Make sure the unit is level.

Do NOT install the unit in the following places:

- In potentially explosive atmospheres.
- In places where there is machinery that emits electromagnetic waves. Electromagnetic waves may disturb the control system, and cause malfunction of the equipment.
- In places where there is a risk of fire due to the leakage of flammable gases (example: thinner or gasoline), carbon fibre, ignitable dust.
- In places where corrosive gas (example: sulphurous acid gas) is produced. Corrosion of copper pipes or soldered parts may cause the refrigerant to leak.

### 2.2.3. Refrigerant



#### NOTICE

Make sure refrigerant piping installation complies with applicable legislation. In Europe, EN378 is the applicable standard.



#### NOTICE

Make sure the field piping and connections are not subjected to stress.



#### WARNING

During tests, NEVER pressurize the product with a pressure higher than the maximum allowable pressure (as indicated on the nameplate of the unit).



#### WARNING

Take sufficient precautions in case of refrigerant leakage. If refrigerant gas leaks, ventilate the area immediately. Possible risks:

- Excessive refrigerant concentrations in a closed room can lead to oxygen deficiency.
- Toxic gas may be produced if refrigerant gas comes into contact with fire.



#### WARNING

Always recover the refrigerants. Do NOT release them directly into the environment. Use a refrigerant reclaim unit to evacuate the installation.

- Only use phosphoric acid deoxidised seamless copper with annealed temper grade.

### 2.2.4. Water



#### NOTICE

Make sure water quality complies with EU directive 98/83 EC.

### 2.2.5. Electrical



#### DANGER: RISK OF ELECTROCUTION

- Turn OFF all power supply before removing the switch box cover, connecting electrical wiring or touching electrical parts.
- Disconnect the power supply for more than 1 minute, and measure the voltage at the terminals of main circuit capacitors or electrical components before servicing. The voltage must be less than 50 V DC before you can touch electrical components. For the location of the terminals, see the wiring diagram.
- Do NOT touch electrical components with wet hands.
- Do NOT leave the unit unattended when the service cover is removed.



#### WARNING

If not factory installed, a main switch or other means for disconnection, having a contact separation in all poles providing full disconnection under overvoltage category III condition, shall be installed in the fixed wiring.



#### WARNING

- Only use copper wires.
- All field wiring must be performed in accordance with the wiring diagram supplied with the product.
- NEVER squeeze bundled cables and make sure they do not come in contact with the piping and sharp edges. Make sure no external pressure is applied to the terminal connections.
- Make sure to install earth wiring. Do NOT earth the unit to a utility pipe, surge absorber, or telephone earth. Incomplete earth may cause electrical shock.
- Make sure to use a dedicated power circuit. NEVER use a power supply shared by another appliance.
- Make sure to install the required fuses or circuit breakers.
- Make sure to install an earth leakage protector. Failure to do so may cause electric shock or fire.

Install power cables at least 1 meter away from televisions or radios to prevent interference. Depending on the radio waves, a distance of 1 meter may not be sufficient.



#### WARNING

- After finishing the electrical work, confirm that each electrical component and terminal inside the electrical components box is connected securely.
- Make sure all covers are closed before starting up the unit.

### 2.2.6. Meaning of used items

**Dealer:**

Sales distributor for the product.

**Authorized installer:**

Technical skilled person who is qualified to install the product.

**User:**

Person who is owner of the product and/or operates the product.

**Applicable legislation:**

All international, European, national and local directives, laws, regulations and/or codes that are relevant and applicable for a certain product or domain.

**Service company:**

Qualified company which can perform or coordinate the required service to the product.

**Installation manual:**

Instruction manual specified for a certain product or application, explaining how to install, configure and maintain it.

**Operation manual:**

Instruction manual specified for a certain product or application, explaining how to operate it.

**Accessories:**

Labels, manuals, information sheets and equipment that are delivered with the product and that need to be installed according to the instructions in the accompanying documentation.

**Optional equipment:**

Equipment made or approved by Daikin that can be combined with the product according to the instructions in the accompanying documentation.

**Field supply:**

Equipment not made by Daikin that can be combined with the product according to the instructions in the accompanying documentation.

## 3. About the box

- At delivery, the unit must be checked for damage. Any damage must be reported immediately to the carrier's claims agent.
- Bring the packed unit as close as possible to its final installation position to prevent damage during transport.

### 3.1. Indoor unit

#### 3.1.1. To unpack the indoor unit

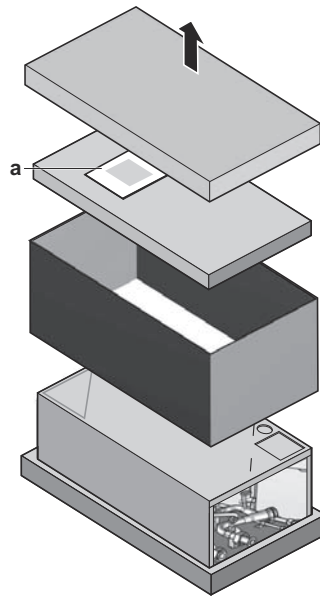
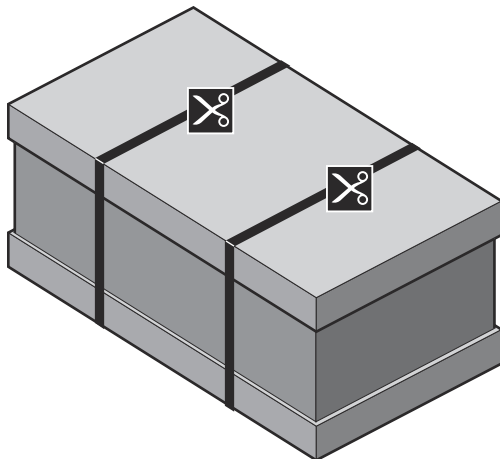

a Installation/operation manual



#### INFORMATION

Do NOT throw away the upper cardboard cover. On the inside of the cardboard cover, the installation pattern is printed.

#### 3.1.2. To remove the accessories from the indoor unit

The installation/operation manual indoor unit is located in the upper part of the box. Follow the procedure below to remove the other accessories.

- 1 Unfix front panel.
- 2 Tilt the bottom side of the front panel upwards and remove it.



#### WARNING

Tear apart and throw away plastic packaging bags so that children will not play with them. Children playing with plastic bags face danger of death by suffocation.

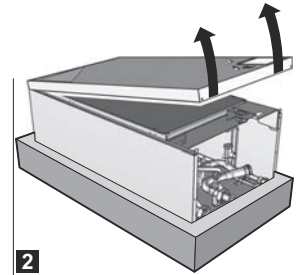
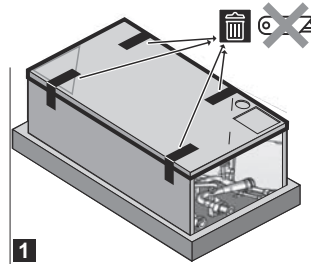

### 3 Remove the accessories.

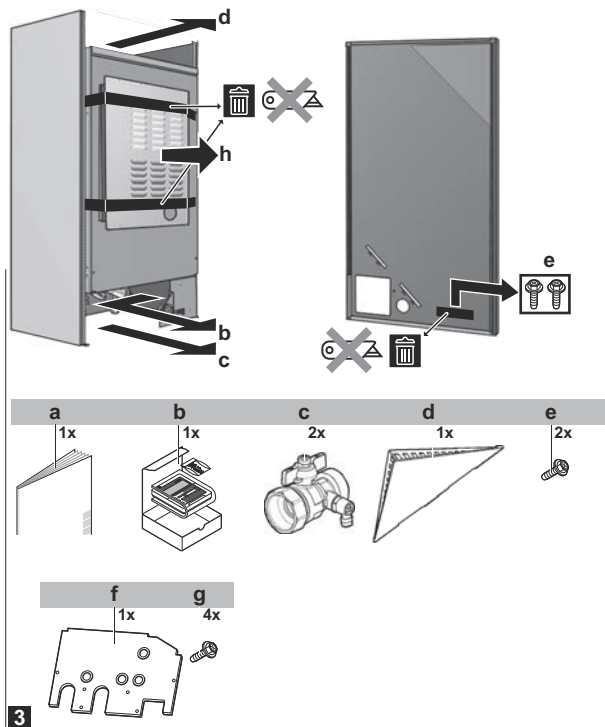

- a HXY(080/125) manual
- b User interface kit: user interface, 4 fixing screws, 2 plugs
- c Shut-off valve
- d User interface cover
- e 2 fixing screws front panel
- f Bottomplate
- g 4 fixing screws bottom plate
- h Topplate

## 4. About the units and options

### 4.1. General information

This installation manual concerns VRV IV indoor unit air to water inverter heat pump units of the Daikin HXY080/125 series.

These units are intended for indoor installation and aimed for commercial and public buildings.

The unit is designed for wall mounted installation.

HXY080/125 units have a heating capacity of 9 kW/14 kW, cooling capacity of 8.2 kW/12.5 kW.

The indoor units are designed to work at indoor ambient temperatures from 5°C to 30°C.

During heating operation, the unit can heat up water to temperatures of 25°C to 45°C, cooling operation of 5°C to 20°C.

The units are designed for indoor installation (outdoor temperatures: cooling 10°C to 43°C, heating: -20°C to 24°C) (for details see technical data book).

### 4.1. Identification



#### NOTICE

When installing or servicing several units at the same time, make sure NOT to switch the service panels between different models.

### 4.1.1. Identification label: Indoor unit

#### Location

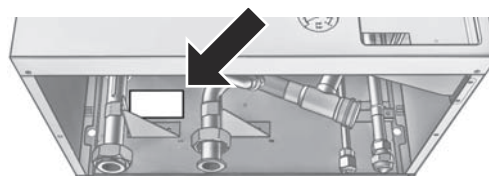

#### Model identification

Modelname: HXY080A8V1B, HXY125A8V1B

Code	Description
H	Hydro Box
X	VRV connection
Y	Reversible applications (cooling + heating)
080	Capacity class (approx.): <ul style="list-style-type: none"> <li>■ 080 kW x 10 cooling capacity</li> <li>■ 125 kW x 10 cooling capacity</li> </ul>
A8	Series
V1	Voltage 1 P~, 220-240 V, 50 Hz
B	European Market

### 4.2. Possible combinations of units and options

#### 4.2.1. List of options for indoor unit

##### User interface (EKRUHT)

The user interface is delivered as an accessory with the unit. An additional user interface is optionally available.

The additional user interface can be connected to have both:

- Control close to the indoor unit.
- Room thermostat functionality in the principal space to be heated.

##### Room thermostat (EKRTWA, EKTRTR1)

You can connect an optional room thermostat to the indoor unit. This thermostat can either be wired (EKRTWA) or wireless (EKTRTR1).

For installation instructions, see the installation manual of the room thermostat.



#### NOTICE

An additional 230 V AC power supply is required for the EKTRTR1 room thermostat.

##### Remote sensor for wireless thermostat (EKRTETS)

You can use a wireless indoor temperature sensor (EKRTETS) only in combination with the wireless thermostat (EKTRTR1).

For installation instructions, see the installation manual of the room thermostat.

##### Demand PCB (EKRP1AHTA)

An optional EKRP1AHTA demand PCB can be connected to the indoor unit. This PCB is needed when an external room thermostat is installed and provides the communication with the indoor unit.

Refer to the demand PCB installation manual for further details.

Refer to the wiring diagram or connection diagram for connecting this PCB to the unit and ["7.3.5. To connect the electrical wiring on the indoor unit" on page 14.](#)

##### Heat pump convector (FWXV)

An optional FWXV convector for heating/cooling operation can be connected to this indoor unit.

Refer to the heat pump convector installation manual for further details.

## Drain pan kit (EKHBDPCA2)

The drain pan is required to drain accumulated condensation from the indoor unit. It is required during low temperature cooling operation of the indoor unit and when the leaving water temperature is <math>18^{\circ}\text{C}</math>.

For installation of this option into the indoor unit, refer to the installation manual delivered with this option kit.

## Heater kit (EKBUH)

The heater kit option can be installed to assist the heat pump during heating operation or to provide primary heating during emergency situations<sup>(1)</sup>.

### 4.2.2. Possible combinations of indoor unit and outdoor unit

Indoor unit	Outdoor unit		
	RYYQ8-20	RYMQ	RXYQ
HXY080A8V1B	O	X	X
HXY125A8V1B	O	X	X

O = allowed  
X = not allowed



### INFORMATION

For detailed information, refer to the VRV IV heat pump combination table in Technical Data. Combinations are explained depending on the system layout of the VRV IV heat pump series.

## 5. Application guidelines

### 5.1. Overview: Application guidelines

The purpose of the application guidelines is to give a glance of the possibilities of the Daikin heat pump system.



### NOTICE

- The illustrations in the application guidelines are meant for reference only, and are NOT to be used as detailed hydraulic diagrams. The detailed hydraulic dimensioning and balancing are NOT shown, and are the responsibility of the installer.
- For more information about the configuration settings to optimize heat pump operation, see the configuration chapter.

This chapter contains applications guidelines for:

- Setting up the space heating/cooling system
- Setting up an auxiliary heat source for space heating

### 5.2. Setting up the space heating/cooling system

The Daikin heat pump system supplies leaving water to heat emitters in one or more rooms.

Because the system offers a wide flexibility to control the temperature in each room, you need to answer the following questions first:

- How many rooms are heated (or cooled) by the Daikin heat pump system?
- Which heat emitter types are used in each room and what is their design leaving water temperature?

Once the space heating/cooling requirements are clear, Daikin recommends to follow the setup guidelines below.

(1) More information can be found in the manual of the heater kit and on page "9. Installing the optional EKBUHAA(6V3/6W1) heater kit" on page 26 of this manual.

### 5.2.1. Single room

#### Under floor heating or heat pump convactor – Wired room thermostat

##### Setup

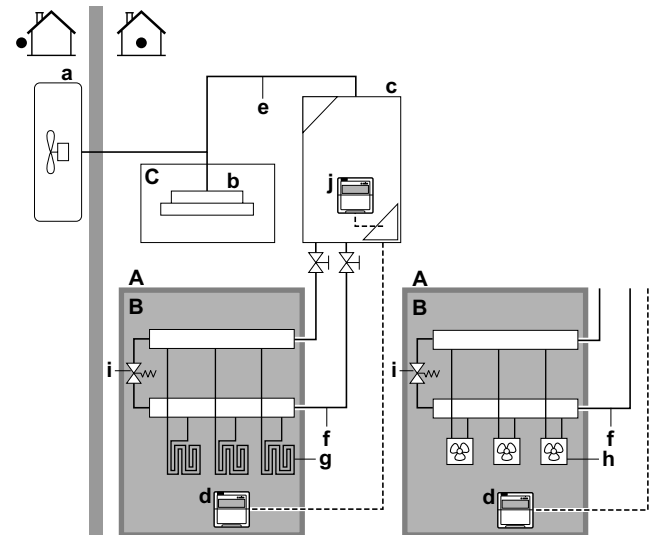

- A Main leaving water temperature zone
- B One single room
- C One single room
- a Outdoor VRV IV heat pump
- b VRV Direct Expansion (DX) Indoor unit cassette
- c HXY(080/125)
- d Optional EKRUHT user interface (master)
- e Refrigerant piping
- f Water piping
- g Floor heating loop
- h Fan coil unit
- i Bypass valve (field supply)
- j User interface (slave)

- The under floor heating or heat pump connection is directly connected to the indoor unit.
- The room temperature is controlled by the user interface, which is used as room thermostat. Possible installations:
  - User interface (standard equipment) installed in the room and used as room thermostat
  - User interface (standard equipment) installed at the indoor unit and used for control close to the indoor unit + user interface (optional equipment EKRUHT) installed in the room and used as room thermostat

##### Benefits

- Cost effective.** You do NOT need an additional external room thermostat.
- Highest comfort and efficiency.** The smart room thermostat functionality can decrease or increase the desired leaving water temperature based on the actual room temperature (modulation). This results in:
  - Stable room temperature matching the desired temperature (higher comfort)
  - Less ON/OFF cycles (more quiet, higher comfort and higher efficiency)
  - Lowest possible leaving water temperature (higher efficiency)
- Easy.** You can easily set the desired room temperature via the user interface:
  - For your daily needs, you can use preset values and schedules.
  - To deviate from your daily needs, you can temporarily overrule the preset values and schedules.



## Under floor heating or heat pump convectors – External room thermostat

### Setup

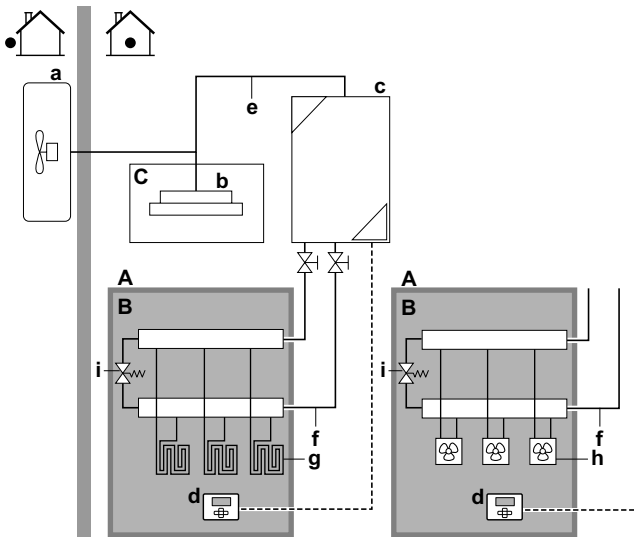

- A Main leaving water temperature zone
- B One single room
- C One single room
- a Outdoor VRV IV heat pump
- b VRV Direct Expansion (DX) Indoor unit cassette
- c HXY(080/125)
- d External room thermostat
- e Refrigerant piping
- f Water piping
- g Floor heating loop
- h Fan coil unit
- i Bypass valve (field supply)

- The under floor heating or heat pump convectors are directly connected to the indoor unit.
- The room temperature is controlled by the external room thermostat (demand PCB is needed for this option).

### 5.3. Using an auxiliary heat source

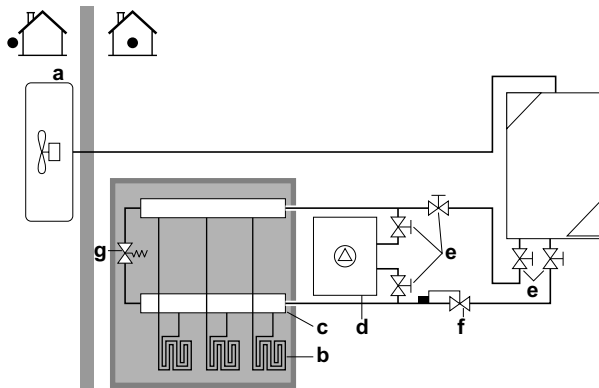

- a Outdoor VRV IV heat pump
- b Floor heating loop (field supply)
- c Collector (field supply)
- d Auxiliary heat source (field supply)
- e Shut-off valve
- f Aquastat valve (field supply)
- g Bypass valve (field supply)



#### NOTICE

- Make sure the auxiliary boiler and its integration in the system complies with applicable legislation.
- Daikin is NOT responsible for incorrect or unsafe situations in the auxiliary boiler system.

- Make sure the return water to the heat pump does NOT exceed 45°C. To do so:

- Set the desired water temperature via the auxiliary boiler controller to maximum 45°C.
- Install an aquastat valve in the return water flow of the heat pump.
- Set the aquastat valve to close above 45°C and to open below 45°C.

- Install non-return valves.

- Make sure to only have one expansion vessel in the water circuit. An expansion vessel is already premounted in the indoor unit.

Alternative option EKBUH can be considered. The heater kit option will provide additional capacity in case of heat pump capacity shortage. See "9. Installing the optional EKBUHAA(6V3/6W1) heater kit" on page 26 for details.

## 6. Preparation

### 6.1. Preparing installation site

Do NOT install the unit in places often used as work place. In case of construction works (e.g. grinding works) where a lot of dust is created, the unit must be covered.

Choose the installation location with sufficient place for carrying the unit in and out of the site.

#### 6.1.1. Installation site requirements of the indoor unit



#### WARNING

Be sure to provide for adequate measures in order to prevent that the unit is used as a shelter by small animals

Small animals making contact with electrical parts can cause malfunctions, smoke or fire. Please instruct the customer to keep the area around the unit clean and clear.

Select an installation site that meets the following requirements:

- All piping lengths and distances have been taken into consideration (for requirements of piping length for the refrigerant piping, refer to the outdoor unit installation manual):
- Mind the measurement guidelines:

Requirement	Value
Maximum refrigerant piping length between indoor unit and outdoor unit.	<135 m <sup>(a)</sup>
Maximum height difference between indoor unit and outdoor unit.	<15 m <sup>(a)</sup>

(a) Refer to VRV IV piping length restrictions to judge the complete VRV system integration.



#### NOTICE

Mind the following spacing installation guidelines.

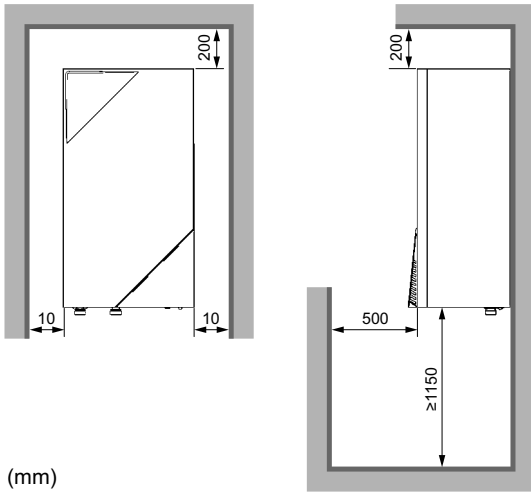

(mm)

- The space around the unit allows for sufficient air circulation.
- There is no danger of fire due to leakage of inflammable gas.
- The equipment is not intended for use in a potentially explosive atmosphere.
- Take care that in the event of a water leak, water cannot cause any damage to the installation space and surroundings.
- Be sure that sufficient precautions are taken, in accordance with the applicable legislation, in case of refrigerant leakage.
- When installing the unit in a small room, take measures in order to keep the refrigerant concentration from exceeding allowable safety limits in the event of a refrigerant leak.



#### WARNING

Excessive refrigerant concentrations in a closed room can lead to oxygen deficiency.

- Do not climb, sit or stand on top of the unit.
- Do not place any objects or equipment on top of the unit (top plate).

Do NOT install the unit in places such as:

- Where there is mist of mineral oil, oil spray or vapour. Plastic parts may deteriorate, and cause them to fall out or water to leak.
- Do NOT install the unit in sound sensitive areas (e.g. near a bedroom and the like), so that the operation noise will cause no trouble.  
Note: If the sound is measured under actual installation conditions, the measured value will be higher than the sound pressure level mentioned in Sound spectrum due to environmental noise and sound reflections.
- The foundation must be strong enough to bear the weight of the unit.  
Make sure, in the event of a water leak, water cannot cause any damage to the installation space and surroundings.
- In places with high humidity (max. RH=85%), for example a bathroom.
- In places where frost is possible. Ambient temperature around the indoor unit should be  $>5^{\circ}\text{C}$ .
- The indoor unit is designed for indoor installation only and for indoor ambient temperatures ranging  $5\text{--}35^{\circ}\text{C}$  in cooling mode and  $5\text{--}30^{\circ}\text{C}$  in heating mode.

## 6.2. Preparing water circuit

### 6.2.1. Selection of the type of heat emitters

The selection of the heat emitter is the choice of the end customer. The choice of the heat emitter will define the needed water temperature from the unit.

Based on the needed water temperature for the heat emitters, following range can be defined:

- 1 Low temperature (heating leaving water temperature range from  $25^{\circ}\text{C}$  to  $40^{\circ}\text{C}$ , cooling leaving water temperature range from  $25^{\circ}\text{C}$  to  $18^{\circ}\text{C}$ ).  
Typical example: floor heating.
- 2 Medium temperature (leaving water temperature range from  $40^{\circ}\text{C}$  to  $45^{\circ}\text{C}$ , cooling leaving water temperature range from  $12^{\circ}\text{C}$  to  $7^{\circ}\text{C}$ ).  
Typical example: low temperature radiators (heating) and convectors (heating and cooling).

Once the heat emitters are chosen, the capacity of these heat emitters should be defined and from this the dimensioning and position of the heat emitters in the different rooms should be decided.

An important parameter of the heat emitters is the temperature difference between entering water and leaving water.

This will define the water flow in the system.

Finally, the piping layout from the heat source to the different heat emitters needs to be drawn.

This will finally define following important parameters:

- Minimal water volume in the system.
- Maximal water volume in the system.
- Minimal and maximal water flow in system.
- Maximal pressure drop in the system.

### 6.2.2. Water circuit requirements

- Use the indoor unit only in a closed water system. Using the system in an open water system will lead to excessive corrosion.
- Maximum water temperature is 45°C (heating) and minimum water temperature is 5°C (cooling).
- The maximum water pressure is 3 bar. Provide adequate safeguards in the water circuit to ensure that the maximum pressure is NOT exceeded.
- All installed piping and piping accessories (valve, connections,...) must withstand the following temperatures.



#### INFORMATION

The following illustration is an example and may NOT match your system layout.

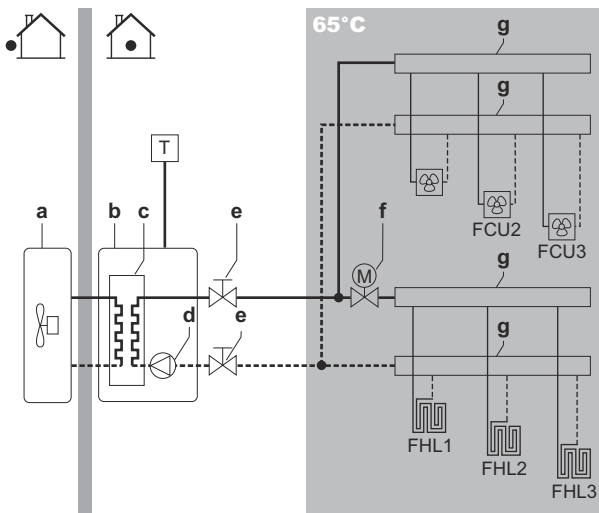

- a Outdoor unit (VRV IV heat pump)
- b Indoor unit HXY(080/125)
- c Heat exchanger
- d Pump
- e Shut-off valve
- f Motorised 2-way valve (field supply)
- g Collector
- FCU1...3 Fan coil unit (optional)
- FHL1...3 Floor heating loop (optional)
- T Room thermostat (optional)

- Shut-off valves delivered with the unit should be installed so that normal servicing can be accomplished without draining the system.
- Make all water piping connections in accordance with the applicable legislation and the outlook diagram that is delivered with the unit, respecting the water inlet and outlet.
- Do NOT use excessive force when connecting the piping. Deformation of the piping can cause malfunctioning of the unit.
- Provide drain taps at all low points of the system in order to allow complete drainage of the water circuit.
- Provide a proper drain for the pressure relief valve to avoid water coming into contact with electrical parts.
- Provide air vents at all high points of the system, which must also be easily accessible for servicing. An automatic air purge is provided in the indoor unit. Check that the air purge is NOT tightened too much, so that automatic release of air in the water circuit is possible.
- Only use materials that are compatible with water used in the system and with the materials used in the indoor unit.
- Check that all components in the field piping can withstand the water pressure and water temperature.
- When using non-brass metallic piping, insulate the brass and non-brass properly so that they do NOT make contact with each other. This to prevent galvanic corrosion.

- Never use Zn-coated parts in the water circuit. Because the unit's internal water circuit uses copper piping, excessive corrosion may occur.
- Only use appropriate tooling to handle brass, which is a soft material. If NOT, pipes will get damaged.
- Select the water piping diameter in relation to the required water flow and the available external static pressure of the pump. See "14. Technical Data" on page 40 for the external static pressure curves of the indoor unit.
- You can find the minimum required water flow for the indoor unit operation in the following table. When the water flow is lower, flow malfunction A6 will be displayed and the indoor unit will be stopped.

Model	Minimum water flow (l/min)
HXY080A8V1B	15
HXY125A8V1B	15

- It is strongly recommended to install an additional filter on the heating water circuit. Especially to remove metallic particles from the field heating piping, it is advised to use a magnetic or cyclone filter, which can remove small particles. Small particles may damage the unit and will NOT be removed by the standard filter of the heat pump system.
- If air or dust gets into the water circuit, problems may occur. To prevent this:
  - Only use clean pipes
  - Hold the pipe end downwards when removing burrs.
  - Cover the pipe end when inserting it through a wall, to prevent dust and/or particles entering the pipe.
  - Use a decent thread sealant to seal connections.
- For safety reasons, it is NOT allowed to add any kind of glycol to the water circuit.
- The installation must be in compliance with the applicable legislation and may require additional hygienic installation measures.
- In accordance with the applicable legislation, it may be necessary to install thermostatic mixing valves.

### 6.2.3. Formula to calculate the expansion vessel pre-pressure

The pre-pressure (Pg) of the vessel depends on the installation height difference (H):

$$Pg=0.3+(H/10) \text{ (bar)}$$

### 6.2.4. To check the water volume

The indoor unit has an expansion vessel of 10 litre with a factory set pre-pressure of 1 bar.

To make sure that the unit operates properly:

- You must check the minimum and maximum water volume.
- You might need to adjust the pre-pressure of the expansion vessel.

## Minimum water volume

Check that the total water volume in the installation is minimum 20 liter, the internal water volume of the indoor unit NOT included.

### INFORMATION

In critical processes, or in rooms with a high heat load, extra water might be required

### NOTICE

When circulation in each space heating loop is controlled by remotely controlled valves, it is important that the minimum water volume is guaranteed, even if all of the valves are closed.

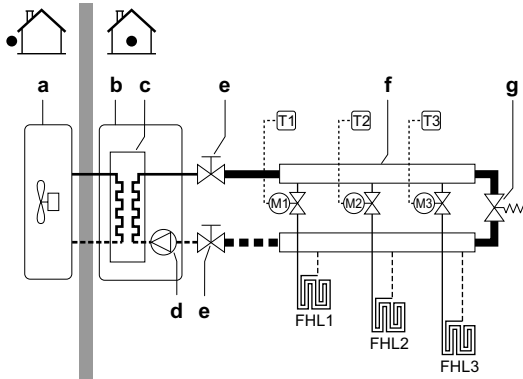

- a Outdoor unit (VRV IV heat pump)
- b Indoor unit HXY(080/125)
- c Heat exchanger
- d Pump
- e Shut-off valve
- f Collector (field supply)
- g By-pass valve (field supply)
- FHL1...3 Floor heating loop (field supply)
- T1...3 Individual room thermostat (optional)
- M1...3 Individual motorised valve to control loop FHL1...3 (field supply)

## Maximum water volume

Use the following graph to determine the maximum water volume for the calculated pre-pressure.

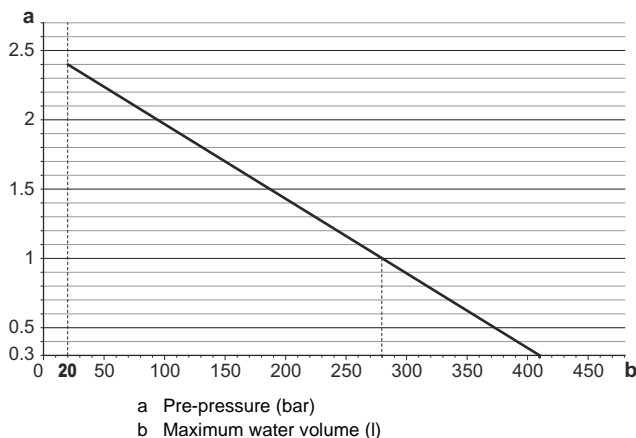

## Example: Maximum water volume and expansion vessel pre-pressure

Installation height difference <sup>(a)</sup>	Water volume	
	≤ 280 l	>280 l
≤7 m	No pre-pressure adjustment is required.	Do the following: <ul style="list-style-type: none"> <li>• Decrease the pre-pressure.</li> <li>• Check if the water volume does NOT exceed the maximum allowed water volume.</li> </ul>
>7 m	Do the following: <ul style="list-style-type: none"> <li>• Increase the pre-pressure.</li> <li>• Check if the water volume does NOT exceed the maximum allowed water volume.</li> </ul>	The expansion vessel of the indoor unit is too small for the installation.

(a) This is the height difference (m) between the highest point of the water circuit and the indoor unit. If the indoor unit is at the highest point of the installation, the installation height is 0 m.

### 6.2.5. Changing the pre-pressure of the expansion vessel



#### NOTICE

Only a licensed installer may adjust the pre-pressure of the expansion vessel.

When changing the default pre-pressure of the expansion vessel (1 bar) is required, take following guidelines into account:

- Only use dry nitrogen to set the expansion vessel pre-pressure.
- Inappropriate setting of the expansion vessel pre-pressure will lead to malfunction of the system.

Changing the pre-pressure of the expansion vessel should be done by releasing or increasing nitrogen pressure through the schröder valve of the expansion vessel.

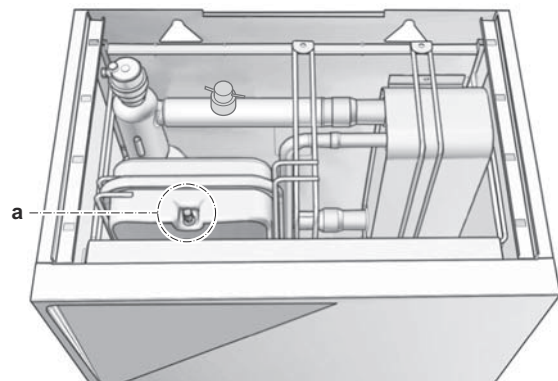

a Schröder valve

### 6.2.6. To check the water volume: Examples

#### Example 1

The indoor unit is installed 5 m below the highest point in the water circuit. The total water volume in the water circuit is 100 l.

No actions or adjustments are required.

#### Example 2

The indoor unit is installed at the highest point in the water circuit. The total water volume in the water circuit is 350 l.

Actions:

- Because the total water volume (350 l) is more than the default water volume (280 l), the pre-pressure must be decreased.
- The required pre-pressure is:  
 $P_g = (0.3 + (H/10)) \text{ bar} = (0.3 + (0/10)) \text{ bar} = 0.3 \text{ bar}$ .
- The corresponding maximum water volume at 0.3 bar is 410 l. (See the graph in the chapter above).
- Because 350 l is lower than 410 l, the expansion vessel is appropriate for the installation.

### 6.3. Preparing electrical wiring

#### 6.3.1. About preparing electrical wiring



#### WARNING

- Establish proper earthing. Do NOT earth the unit to a utility pipe, surge absorber, or telephone earth. Incomplete earthing may cause electrical shock.
- Install the required fuses or circuit breakers.
- Secure the electrical wiring with cable ties so that the cables do NOT come in contact with the piping or sharp edges, particularly on the high-pressure side
- Do NOT use taped wires, stranded conductor wires, extension cords, or connections from a star system. They can cause overheating, electrical shock or fire.
- All wiring must be performed by an authorized electrician and must comply with the applicable legislation.
- Make electrical connections to the fixed wiring.
- All components procured on the site and all electrical construction must comply with the applicable legislation.



#### WARNING

- The indoor unit should have a dedicated power supply.

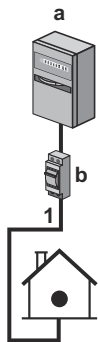

- a Normal power supply
- b Fuse
- 1 Power supply for indoor unit

- The optional heater kit (EKBUH) should have a dedicated power supply.

### 6.3.2. Overview of electrical connections on the indoor unit

The following illustration shows the required field wiring.



#### INFORMATION

- The following illustration is an example and may NOT match your system layout.
- For details see "14.2. Wiring diagram" on page 41.

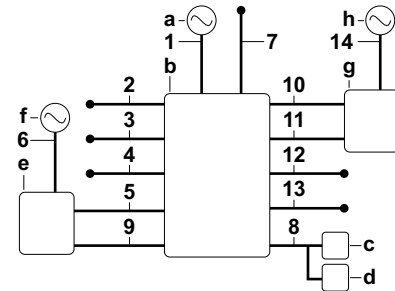

- a Dedicated power supply for the indoor unit
- b HXY(080/125)
- c User interface
- d Optional user interface
- e Optional heater kit
- f Dedicated power supply for the external backup heater kit
- g Optional room thermostat
- h 230 V AC power supply

Item	Description	Wiring	Maximum running current
<b>High voltage wiring (High voltage bundle)</b>			
1	Indoor unit power supply	2+GND	(a)
2	malfunction output	2	0.3 A <sup>(b)</sup>
3	Operation ON/OFF output	2	0.3 A <sup>(b)</sup>
4	Cooling/heating output	2	0.3 A <sup>(b)</sup>
5	Heater kit step 1/2 output	3	(b)
6	External heater kit power supply	For details refer to the installation manual provided with the option kit.	
<b>Low voltage wiring (Low voltage bundle)</b>			
7	Indoor/outdoor transmission	2	(c)
8	User interface transmission	2	(c)
9	External heater kit safety	2	(b)
10	Thermostat input 1	2	(b)
11	Thermostat input 2	2	(b)
12	Operation ON signal	2	(b)
13	Operation OFF signal	2	(b)
14	230 V AC power supply (only for wireless room thermostat EKTR1)	2	<1 A

- (a) Refer to name plate on the indoor unit.
- (b) Minimum cable section 0.75 mm<sup>2</sup>.
- (c) Cable section between 0.75 mm<sup>2</sup> and 1.25 mm<sup>2</sup>.

## 7. Installation

Before installing, first read the instructions of previous chapter.

### INFORMATION

Installation shall be done by an installer, the choice of materials and installation shall comply with the applicable legislation. In Europe the EN378 is the applicable standard that shall be used.

### 7.1. Mounting the indoor unit

#### 7.1.1. To install the indoor unit

1 Remove the accessories from the unit, see instructions in chapter "3.1.2. To remove the accessories from the indoor unit" on page 4.

### WARNING

Tear apart and throw away plastic packaging bags so that children will not play with them. Children playing with plastic bags face danger of death by suffocation.

2 Install indoor unit as follows.

### CAUTION

Do NOT grasp the piping to lift the indoor unit.

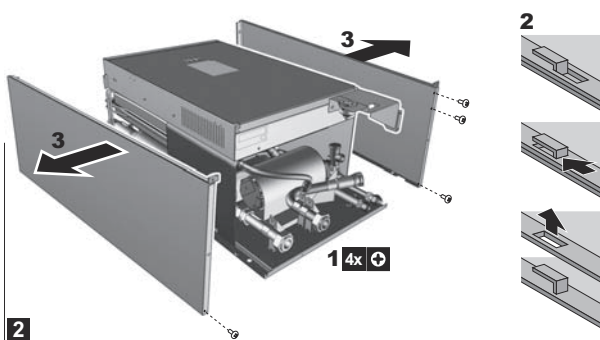
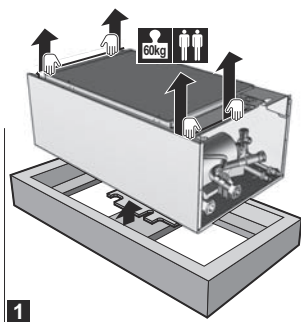

### NOTICE

Please install following the spacing installation guidelines as described in "6.1.1. Installation site requirements of the indoor unit" on page 7.

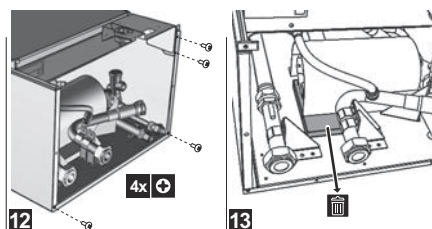
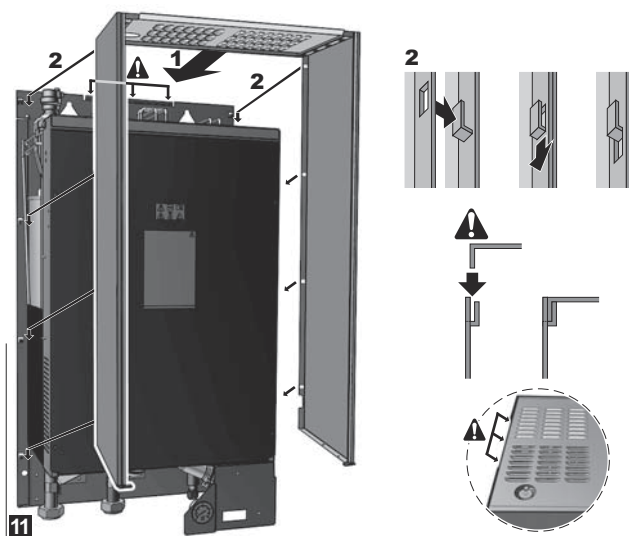
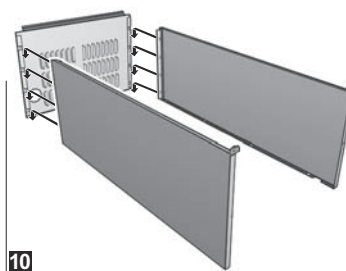
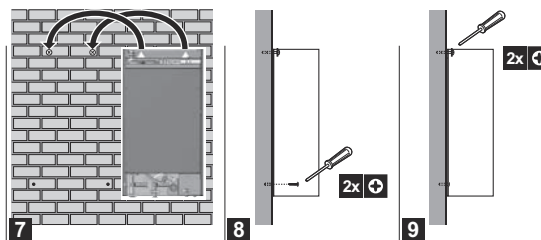
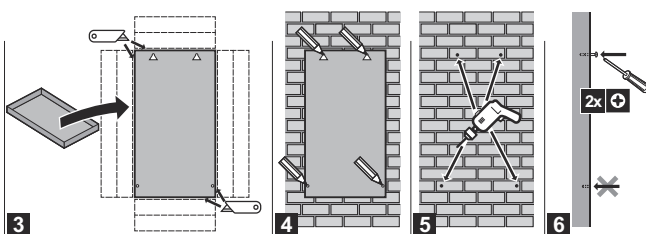

#### 7.1.2. To install the drainpan kit

If a drain pan kit (EKHBDPCA2) is required, install it before connecting the refrigerant and water pipes and the electrical wiring.

To install, see the installation manual of the drain pan kit.

#### 7.1.3. To connect the refrigerant piping to the outdoor unit

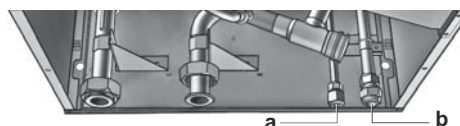

a Refrigerant liquid connection Ø9.52 mm  
b Refrigerant gas connection Ø15.9 mm

- 1 Connect the liquid piping from the outdoor unit to the refrigerant liquid connection of the indoor unit.
- 2 Connect the gas piping from the outdoor unit to the refrigerant gas connection of the indoor unit.

For details concerning vacuuming and operating the unit during vacuuming, see installation manual of outdoor unit.

For details concerning piping sizes and refnet selection, see installation manual of the outdoor unit.



**NOTICE**

Do NOT put power on the unit before vacuuming is completed. In case this happened, refer to the instructions in the installation manual of the outdoor unit to avoid dirt, air or nitrogen to be trapped in the piping.

**7.2. Connecting the water piping**

**7.2.1. To connect the water piping**



**NOTICE**

Do NOT use excessive force when connecting the piping. Deformation of the piping can cause malfunctioning of the unit.

To facilitate service and maintenance, 2 shut-off valves are provided. Mount the valves on the water inlet and on the water outlet. Mind their position. Orientation of the integrated drain valves is important for servicing.

- 1 Install the shut-off valves on the water pipes.

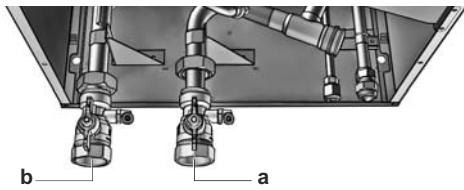

a Water inlet  
b Water outlet

- 2 Screw the indoor unit nuts on the shut-off valves.
- 3 Connect the field piping on the shut-off valves.



**NOTICE**

It is recommended to install a pressure reducing valve on the cold water inlet in accordance with the applicable legislation.

**7.2.2. To install the bottom plate and connect safety valve drain hose**

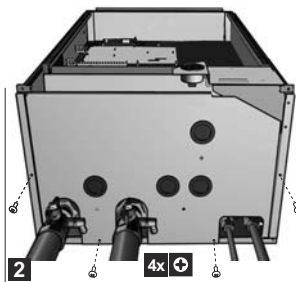
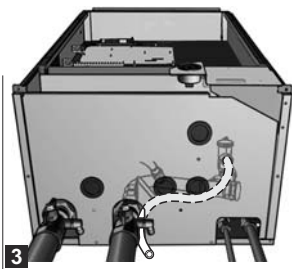
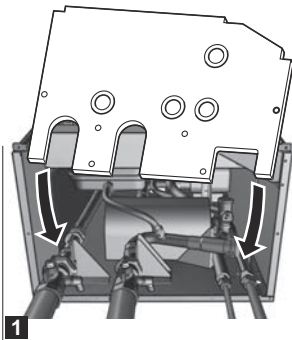

**7.2.3. To fill the water circuit**

- 1 Connect the water supply hose to the drain and fill valve.

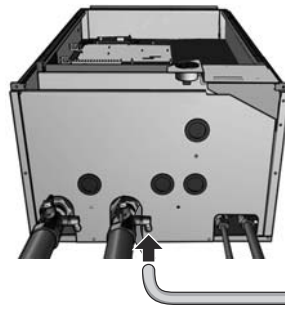

- 2 Open the drain and fill valve.
- 3 Make sure that the automatic air purge valve is open (at least 2 turns).
- 4 Fill the circuit with water until the manometer indicates a pressure of  $\pm 2.0$  bar.
- 5 Purge as much air as possible from the water circuit.



**NOTICE**

- Air in the water circuit can cause malfunctioning of the flow switch. During filling, it may not be possible to remove all the air from the circuit. Remaining air will be removed through the automatic air purge valves during the initial operating hours of the system. Additional filling with water afterwards may be required. Pump only operation in order to purge the air of the system is possible through field settings. Refer to field settings of [E-04] in the chapter "[E] Service mode" on page 21 for further details.
- The unit might dispose some excessive water through the pressure relief valve.
- Water quality must be accordingly to EU directive 98/83 EC.

- 6 Close the drain and fill valve.
- 7 Disconnect the water supply hose from the drain and fill valve.



**NOTICE**

The water pressure needle on the manometer will vary depending on the water temperature (higher pressure at higher water temperature). However, at all times water pressure shall remain above 1 bar to avoid air entering the circuit.

**7.2.4. To insulate the water piping**

The piping in the complete water circuit must be insulated to prevent condensation during cooling operation and reduce capacity losses during heating and cooling operations.

If the temperature is higher than 30°C and the humidity is higher than RH 80%, the thickness of the sealing materials should be at least 20 mm to prevent condensation on the surface of the sealing.

## 7.3. Connecting the electrical wiring

### 7.3.1. Precautions on electrical wiring work



#### WARNING: Electrical Installation

All field wiring and components must be installed by an installer and must comply with the applicable legislation.



#### NOTICE

Electrical wiring work recommendations.

To persons in charge of electrical wiring work.

Do not operate the unit until the refrigerant piping is complete. Running the unit before the piping is ready will break the compressor.



#### WARNING

- A main switch or other means for disconnection, having a contact separation in all poles, must be incorporated in the fixed wiring in accordance with the applicable legislation.
- Use only copper wires.
- All field wiring must be carried out in accordance with the wiring diagram supplied with the unit and the instructions given below.
- Never squeeze bundled cables and be sure that it does not come in contact with the non-insulated piping and sharp edges. Be sure no external pressure is applied to the terminal connections.
- Power supply wires must be attached securely.
- Be sure to establish an earth. Do not earth the unit to a utility pipe, surge absorber, or telephone earth. Incomplete earth may cause electrical shock.
- Be sure to install an earth leakage protector in accordance with the applicable legislation. Failure to do so may cause electric shock or fire.
- Be sure to use a dedicated power circuit, never use a power supply shared by another appliance.
- Be sure to install the required fuses or circuit breakers.



#### NOTICE

The equipment described in this manual may cause electronic noise generated from radio-frequency energy. The equipment complies to specifications that are designed to provide reasonable protection against such interference. However, there is no guarantee that interference will not occur in a particular installation.

It is therefore recommended to install the equipment and electric wires keeping proper distances away from stereo equipment, personal computers, etc....

In extreme circumstances you shall keep distances of 3m or more and use conduit tubes for power and transmission lines.



#### INFORMATION

More information about the legend and the location of the wiring diagram of the unit can be found in "14.2. Wiring diagram" on page 41.

The Wiring diagram on the indoor unit is only for the indoor unit.

For the outdoor unit refer to the wiring diagram of the outdoor unit.

### 7.3.2. System overview of field wiring

Field wiring consists out of power supply, indoor-outdoor communication (= transmission F1F2) wiring, wiring of the user interface (=P1P2), wiring for connection of options and field supply accessories.

#### 7.3.3. Requirements

A power supply (refer to the table mentioned in "6.3.2. Overview of electrical connections on the indoor unit" on page 11) must be provided for connection of the unit. The power supply must be protected with the required safety devices, i.e. a main switch, a slow blow fuse on each phase and an earth leakage protector in accordance with applicable legislation.

Selection and sizing of the wiring should be done in accordance with the applicable legislation based on the information mentioned in the table "6.3.2. Overview of electrical connections on the indoor unit" on page 11.

#### 7.3.4. To open the switch box cover

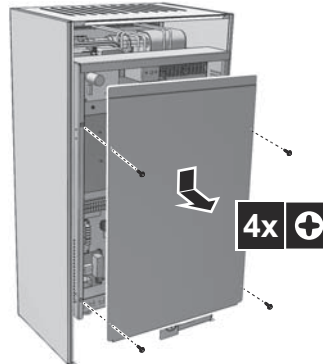

#### 7.3.5. To connect the electrical wiring on the indoor unit



#### NOTICE

Check the table in "6.3.2. Overview of electrical connections on the indoor unit" on page 11 to know which wiring should be routed in the high voltage cable bundle and which wiring should be routed in the low voltage cable bundle.

- 1 Wiring should enter the unit from the bottom.
- 2 Routing of the wiring inside the unit and switchbox should be as follows:

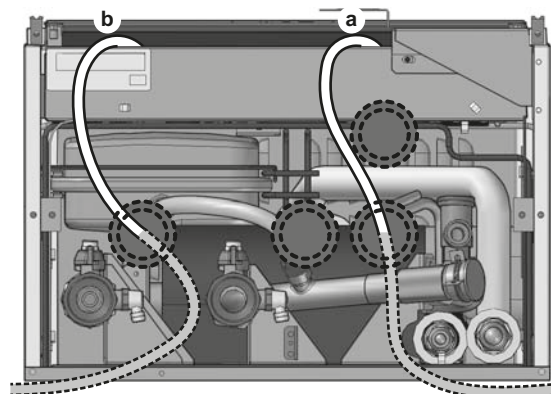



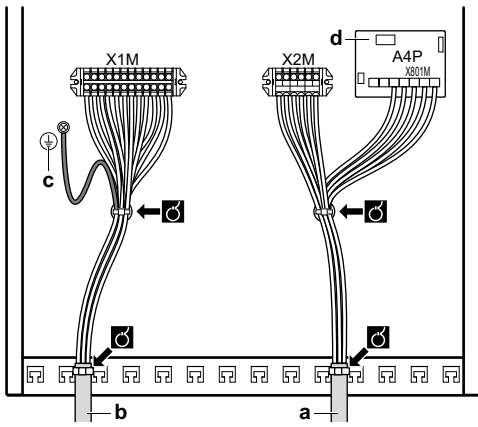

- a Low voltage cable bundle (see "6.3.2. Overview of electrical connections on the indoor unit" on page 11)
- b High voltage cable bundle (see "6.3.2. Overview of electrical connections on the indoor unit" on page 11)
- c Earth connection
- d Optional

3 Fix the cable with cable ties to the cable tie mountings to ensure strain relief and to make sure that it does NOT come in contact with the piping and sharp edges.



**CAUTION**

Do NOT push or place redundant cable length in the unit.

**7.3.6. To connect the user interface**

The unit is equipped with a user interface offering a user-friendly way to set up, use and maintain the unit.

Before operating the user interface, follow this installation procedure.



**NOTICE**

The wiring for connection is not included.

**Procedure**



**NOTICE**

The user interface, delivered in a kit, has to be mounted indoors.

Remove the front part of the user interface  
Insert a slotted screwdriver into the slots (1) in the rear part of the user interface, and remove the front part of the user interface.

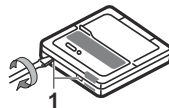

**NOTICE**

The PCB is mounted in the faceplate of the user interface.  
Be careful NOT to damage it.

**Fixation of the user interface to the indoor unit**



**INFORMATION**

For connection to the switchbox see "7.3.5. To connect the electrical wiring on the indoor unit" on page 14.

1 Fix the wallplate of the user interface to the frontplate of the unit.  
For installation of the frontplate, see "7.4.1. To fix the user interface cover to the indoor unit" on page 16.

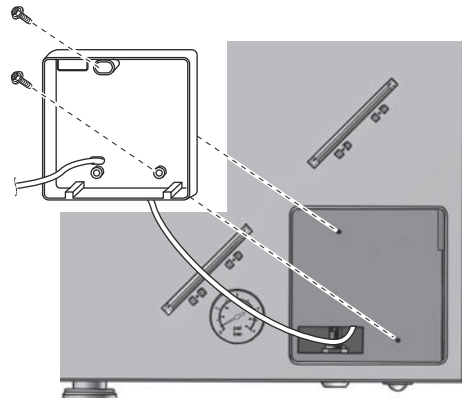

**NOTICE**

Be careful NOT to distort the shape of the backside of the user interface by overtightening the mounting screws..

2 Cut off a 2 wire conductor.

3 Connect the wires to the user interface as shown below.

**From the rear**

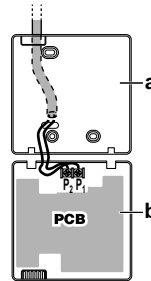

- a Rear part of the user interface
- b Front part of the user interface

4 Reinstall the faceplate onto the wallplate.  
First begin fitting from the clips at the bottom.

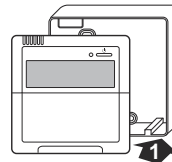

5 Remove the user interface cover from its hinge.



### Fixation of the user interface to the wall in case of installation as room thermostat

- 1 Cut off a 2 wire conductor.
- 2 Fix the wallplate of the user interface to the wall.
- 3 Connect the wires to the user interface as shown below.



#### NOTICE

Be careful NOT to distort the shape of the backside of the user interface by overtightening the mounting screws..

#### From the bottom

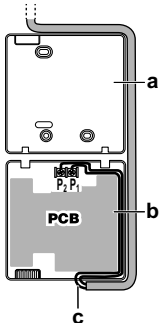

- a Rear part of the user interface
- b Front part of the user interface
- c Use rippers to notch the part for the wiring to pass through

- 4 Reinstall the faceplate onto the wallplate.  
First begin fitting from the clips at the bottom.

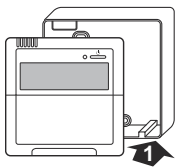

#### INFORMATION

If next to the standard remote controller the optional remote controller is installed as well:

- Connect the electrical wires of both remote controllers in the same way like described above.
- Select a master and a slave remote controller by switching the SS1 selector switch.

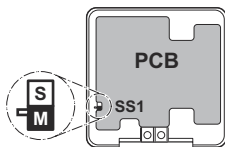

- S Slave
- M Master

Only the remote controller set as master can work as room thermostat.

#### How to connect for multi unit



#### INFORMATION

For multiple unit control, connect the remote controller to the unit as instructed above. For all other units to be controlled by this controller every next unit has to be connected as shown in the figure below (meaning: make a connection from P1 of the previous unit to P1 of the next unit, and make a connection from P2 of the previous unit to P2 of the next unit, and so on...).

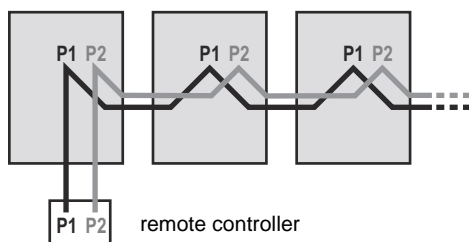

Limitation: 16 indoor units

### 7.4. Finishing the indoor unit installation

#### 7.4.1. To fix the user interface cover to the indoor unit

- 1 Make sure that the front panel is removed from the indoor unit. See To open the indoor unit.
- 2 Plug the hinges into the backside of the front panel.

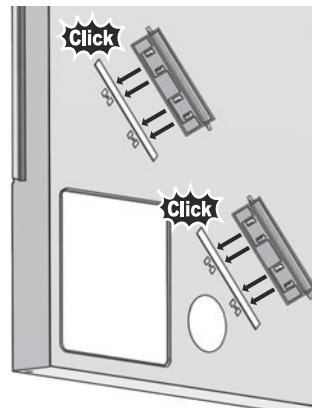

- 3 Plug the user interface cover into the hinges.

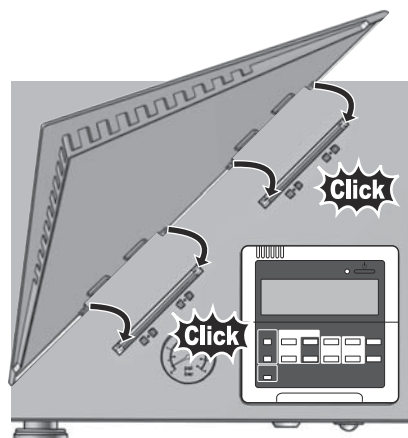

- 4 Mount the front panel to the indoor unit.

#### 7.4.2. To close the indoor unit

- 1 Close the switch box cover.
- 2 Install the front panel as shown below.



#### NOTICE

When closing the indoor unit cover, make sure that the tightening torque does NOT exceed 4.1 Nm.



#### NOTICE

Be careful NOT to pinch the wiring when attaching the frontplate to the unit.

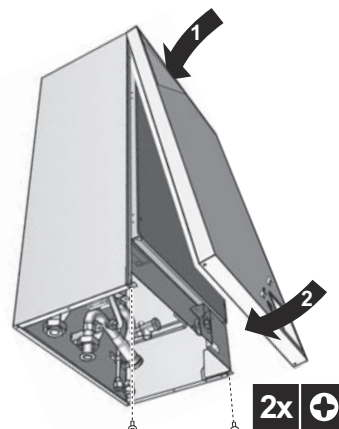

## 8. Commissioning



### NOTICE

It is important that all information in this chapter is read sequentially by the installer and that the system is configured as applicable.

### 8.1. Pre-operation checks



### WARNING

Switch off the power supply before making any connections.

After the installation of the unit, check the following:

#### 1 Field wiring

Make sure that the field wiring has been carried out according to the instructions described in the chapter "6.3. Preparing electrical wiring" on page 11, according to the wiring diagrams and according to European and national regulations.

#### 2 Fuses and protection devices

Check that the fuses and other locally installed protection devices are of the size and type specified in the chapter "Electrical specifications table" on page 43. Make sure that neither a fuse nor a protection device has been bypassed.

#### 3 Earth wiring

Make sure that the earth wires have been connected properly and that the earth terminals are tightened.

#### 4 Internal wiring

Visually check the switch box and the inside of the unit on loose connections or damaged electrical components.

#### 5 Installation

Check that the unit is properly installed, to avoid abnormal noises and vibrations when starting up the unit.

#### 6 Damaged equipment

Check the inside of the unit on damaged components or squeezed pipes.

#### 7 Refrigerant leak

Check the inside of the unit on refrigerant leakage. If there is a refrigerant leak try to repair the leak (recovery, repair, and vacuuming needed). If it is impossible to repair by yourself, call your local dealer.

Do not touch any refrigerant which has leaked out of refrigerant piping connections.

This may result in frostbite.

#### 8 Vacuuming/recovery and refrigerant charging

Refer to the outdoor unit manual for more details.

#### 9 Water leak

Check the inside of the unit on water leakage. In case there is a water leakage try to repair the leak. If it is impossible to repair by yourself, close the water inlet and water outlet shut-off valves and call your local dealer.

#### 10 Power supply voltage

Check the power supply voltage on the local supply panel. The voltage must correspond to the voltage on the identification label of the unit.

#### 11 Air purge valve

Make sure the air purge valve of the heat pump is open (at least 2 turns).

#### 12 Shut-off valves

Make sure that the shut-off valves are correctly installed and fully open.



### NOTICE

Operating the system with closed valves will damage the pump!

Once all checks are fulfilled, the unit must be closed, only then can the unit be powered on. When the power supply to the indoor unit is turned on, "88" is displayed on the user interface during its initialization, which might take up to 30 seconds. During this process the user interface can not be operated.

### 8.2. Final air purging

To get rid of all the air in the system, the pump should be operated.

Therefore, change the field setting [E-04] as explained in the chapter "8.3. Field settings" on page 17. More details about setting "[E-04] Pump only operation (air purge function)" can be found on page 21.

### 8.3. Field settings

The indoor unit should be configured by the installer to match the installation environment (outdoor climate, installed options, etc.) and user demand. Therefore, a number of so called field settings are available. These field settings are accessible and programmable through the user interface on the indoor unit.

Each field setting is assigned a 3-digit number or code, for example [5-03], which is indicated on the user interface display. The first digit [5] indicates the 'first code' or field setting group. The second and third digit [03] together indicate the 'second code'.

A list of all field settings and default values is given in the "8.4. Field setting list for Installation Manual" on page 22. In this list we provided 2 columns to register the date and value of altered field settings at variance with the default value.

#### 8.3.1. Procedure



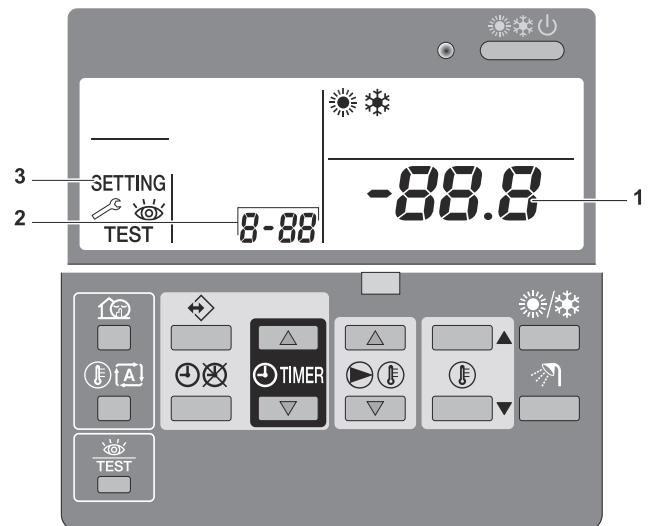

To change one or more field settings, proceed as follows.



- 1 Press the button for a minimum of 5 seconds to enter FIELD SET MODE. The **SETTING** icon (3) will be displayed. The current selected field setting code is indicated **8-88** (2), with the set value displayed to the right **-88.8** (1).
- 2 Press the button to select the appropriate field setting first code.
- 3 Press the button to select the appropriate field setting second code.
- 4 Press the button and button to change the set value of the select field setting.
- 5 Save the new value by pressing the button.

- 6 Repeat step 2 through 4 to change other field settings as required.
- 7 When finished, press the  button to exit FIELD SET MODE.

 **INFORMATION**

- Changes made to a specific field setting are only stored when the  button is pressed. Navigating to a new field setting code or pressing the  button will discard the change made.
- The field settings are grouped by their field setting first code.
- For example, field settings [0-00]; [0-01]; [0-02]; [0-03] are defined as "Group 0".
- When different values are changed within the same group, pressing the  button will save all the values changed within this group.
- Be aware of this when changing field settings within the same group and pressing on the  button.

 **INFORMATION**

- Before shipping, the set values have been set as shown under "8.4. Field setting list for Installation Manual" on page 22.
- When exiting FIELD SET MODE, "88" may be displayed on the user interface LCD while the unit initializes itself.

 **NOTICE**

When running through the field settings you may notice that there are some more field settings as there are mentioned in the "8.4. Field setting list for Installation Manual" on page 22. **These field settings are not applicable and may not be changed!**

**8.3.2. Detailed description**

For a summary of all field settings refer to "8.4. Field setting list for Installation Manual" on page 22.





**[0] Remote control setup**

- [0-00] User permission level**  
The user interface can be programmed to make certain buttons and functions unavailable for the user. There are 2 permission levels defined. Both levels (level 2 and level 3) are basically the same, the only difference is that for level 3 no water temperature settings are possible (see table below).

	Permission	
	level 2	level 3
Operation ON/OFF	Operable	Operable
Setting the leaving water temperature	Operable	—
Setting the room temperature	Operable	Operable
Weather dependent set point operation ON/OFF	Operable	—
Setting the clock	—	—
Programming the schedule timer	—	—
Schedule timer operation ON/OFF	Operable	Operable
Field settings	—	—
malfunction code display	Operable	Operable
Test operation	—	—

By default no level is defined so all buttons and functions are operable.

The actual permission level is determined by field setting. For permission level 2, set field setting [0-00] to 2, for permission level 3, set field setting [0-00] to 3.

Once the field setting is set, the chosen permission level is not yet active. Enabling the selected permission level is done by simultaneously pressing buttons  and  immediately followed by simultaneously pressing buttons  and , and keeping all 4 buttons pressed for at least 5 seconds. Note that no indication on the user interface is given. After the procedure the blocked buttons will not be available anymore.



Deactivating the selected permission level is done in the same way.

- [0-01] Room temperature compensation value**  
If needed, it is possible to adjust some thermistor value of the unit by a correction value. This can be used as countermeasure for thermistor tolerances or capacity shortage. The compensated temperature (= measured temperature plus compensation value) is then used for controlling the system and will be displayed in the temperature read-out mode. See also "[9] Automatic temperature compensation" on page 21 for compensation values for leaving water temperature.
- [0-02] Setting not applicable**
- [0-03] Status: defines whether the ON/OFF instruction can be used in the schedule timer for space heating.**  
Refer to the operation manual for details how to program the schedule timer.  
The schedule timer for space heating can be programmed in 2 different ways: based on the temperature set point (both leaving water temperature and room temperature) and based on the ON/OFF instruction.

 **INFORMATION**

By default space heating based on temperature set point (method 1) is enabled, so only temperature shifts are possible (no ON/OFF instruction).

In the following tables both methods on how to interpret the schedule timer are shown.

Method 1	Space heating based on temperature set point <sup>(a)</sup>
During operation	During schedule timer operation the operation LED is lit continuously.
When pushing the  button	The schedule timer for space heating will stop and will not start again. The controller will be switched off (operation LED will stop working).
When pushing the  button	The schedule timer for space heating will be stopped and will not start again. The schedule timer icon will not be displayed anymore.

(a) For leaving water temperature and/or room temperature

**Operation example:** Schedule timer based on temperature set points.

When setback function (refer to "[2] Automatic setback function" on page 19) is enabled, the setback operation will have priority over the scheduled action in the schedule timer.

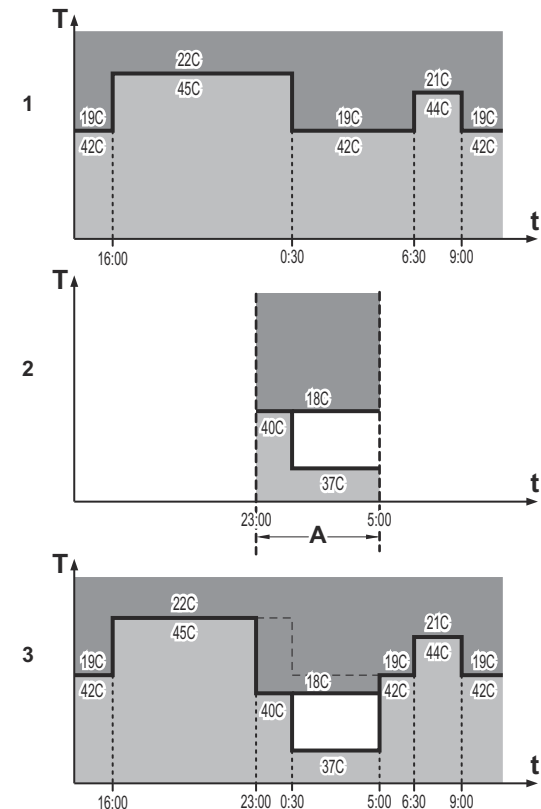

- 1 Schedule timer
- 2 Setback function
- 3 When both setback function and schedule timer are enabled
- A Setback function
- t Time
- T Temperature set point
- Room temperature
- Leaving water temperature

**Operation example:** Schedule timer based on ON/OFF instruction.

When setback function (refer to "[2] Automatic setback function" on page 19) is enabled, the setback operation will have priority over the scheduled action in the schedule timer if ON instruction is active. If OFF instruction is active this will have priority over the setback function. At any time the OFF instruction will have the highest priority.

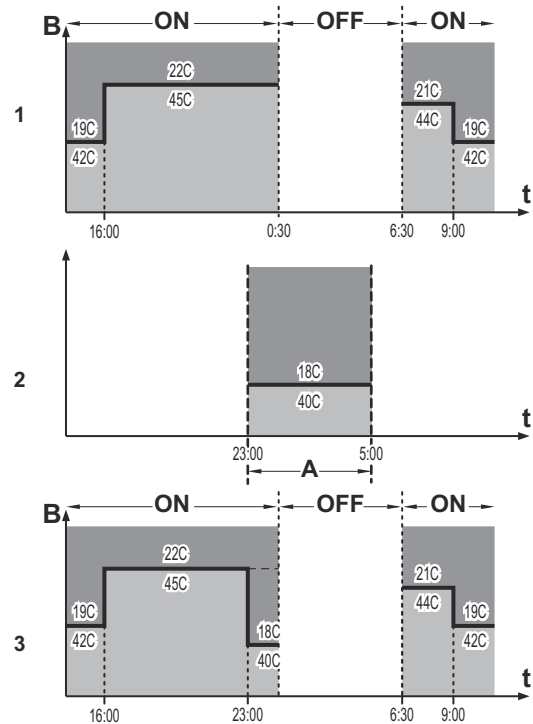

- 1 Schedule timer
- 2 Setback function
- 3 When both setback function and schedule timer are enabled
- A Setback function
- B ON/OFF instruction
- t Time
- T Temperature set point
- Room temperature
- Leaving water temperature

- [0-04] Status: defines whether the ON/OFF instruction can be used in the schedule timer for cooling. Same as for [0-03] but for cooling schedule timer. For cooling, no setback function is available.

**[1] Settings are not applicable**

**[2] Automatic setback function**

Setback function provides the possibility to lower the room temperature. The setback function can for instance be activated during the night because the temperature demands during night and day are not the same.

**INFORMATION**

- By default the setback function is enabled.
- The setback function can be combined with the automatic weather dependent set point operation.
- Setback function is an automatic daily scheduled function.

- [2-00] Status: defines whether the setback function is turned ON (1) or OFF (0)
- [2-01] Start time: time at which setback is started
- [2-02] Stop time: time at which setback is stopped

Setback can be configured for both room temperature control and leaving water temperature control.

Method 2 Space heating based on ON/OFF instruction	
During operation	When the schedule timer switches space heating OFF, the controller will be switched off (operation LED will stop working).
When pushing the  button	The schedule timer for space heating will stop (when active at that moment) and will start again at the next scheduled ON function. The "last" programmed command overrides the "preceding" programmed command and will remain active until the "next" programmed command occurs. Example: imagine the actual time is 17:30 and actions are programmed at 13:00, 16:00 and 19:00. The "last" programmed command (16:00) overruled the "previous" programmed command (13:00) and will remain active until the "next" programmed command (19:00) occurs. So in order to know the actual setting, one should consult the last programmed command. It is clear that the "last" programmed command may date from the day before. Refer to the operation manual. The controller will be switched off (operation LED will stop working). However the schedule timer icon will stay displayed.
When pushing the  button	The schedule timer for space heating will be stopped and will not start again. The schedule timer icon will not be displayed anymore.

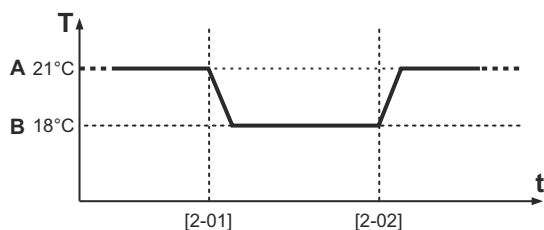

A Normal room temperature set point  
 B Room setback temperature [5-03]  
 t Time  
 T Temperature

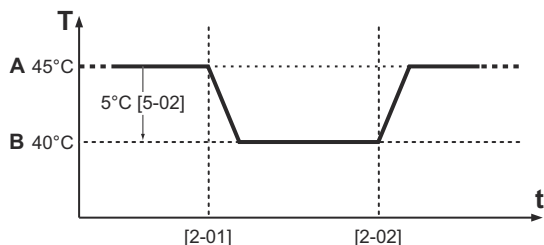

A Normal leaving water temperature set point  
 B Leaving water setback temperature = A - [5-02]  
 t Time  
 T Temperature

Refer to "[5] Automatic setback" on page 20 for temperature set points.

### [3] Weather dependent set point (Heating)

When weather dependent operation is active, the leaving water temperature is determined automatically depending on the outdoor temperature: colder outdoor temperatures will result in warmer water and vice versa. The unit has a floating set point. Activating this operation will result in a lower power consumption than use with a manually fixed leaving water set point.

During weather dependent operation, the user has the possibility to shift up or down the target water temperature by a maximum of 5°C. This "Shift value" is the temperature difference between the temperature set point calculated by the controller and the real set point. E.g. a positive shift value means that the real temperature set point will be higher than the calculated set point.

It is advised to use the weather dependent set point because it adjusts the water temperature to the actual needs for space heating. It will prevent the unit from switching too much between thermo ON operation and thermo OFF operation when using the user interface room thermostat or external room thermostat.

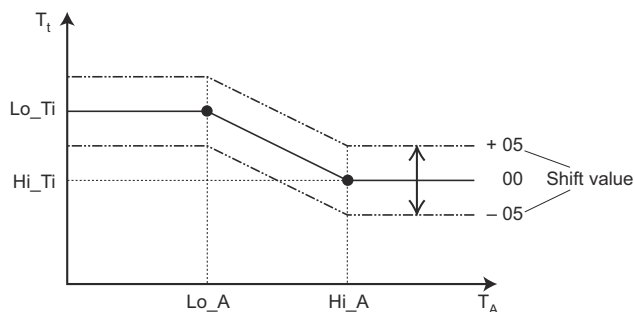

$T_t$  Target water temperature  
 $T_A$  Ambient (outdoor) temperature  
 Shift value = Shift value

- [3-00] Low ambient temperature ( $Lo\_A$ ): low outdoor temperature.
- [3-01] High ambient temperature ( $Hi\_A$ ): high outdoor temperature.

- [3-02] Set point at low ambient temperature ( $Lo\_Ti$ ): the target outgoing water temperature when the outdoor temperature equals or drops below the low ambient temperature ( $Lo\_A$ ). Note that the  $Lo\_Ti$  value should be higher than  $Hi\_Ti$ , as for colder outdoor temperatures (i.e.  $Lo\_A$ ) warmer water is required.
- [3-03] Set point at high ambient temperature ( $Hi\_Ti$ ): the target outgoing water temperature when the outdoor temperature equals or rises above the high ambient temperature ( $Hi\_A$ ). Note that the  $Hi\_Ti$  value should be lower than  $Lo\_Ti$ , as for warmer outdoor temperatures (i.e.  $Hi\_A$ ) less warm water suffices.



### INFORMATION

If by mistake the value of [3-03] is set higher than the value of [3-02], the value of [3-03] will always be used.

### [4] Settings are not applicable

#### [5] Automatic setback

- [5-00] Setting is not applicable.
- [5-01] Setting is not applicable.
- [5-02] Leaving water setback temperature.
- [5-03] Room setback temperature.
- [5-04] Setting is not applicable.

#### [6] Option setup

- [6-01] External room thermostat.  
 If the optional external room thermostat is installed, its operation must be enabled by field setting. Default [6-01]=0, which means no external room thermostat is installed.

- Set [6-01]=2 if the optional external room thermostat is installed. The external room thermostat only gives an ON/OFF signal to the heat pump based on the room temperature.

- Set [6-01]=1 in case a heating thermostat ON or cooling thermostat ON function is required (when using optional EKRTWA or EKRT1). The processing of thermostat ON will depend on the system's operation mode. Room thermostat input 1 = heating input, room thermostat input 2 = cooling input.

Because the external room thermostat does not give continuous feedback information to the heat pump, it is supplementary to the user interface room thermostat function. To have a good control of the system and avoiding frequent ON/OFF it is advised to use the automatic weather dependent set point operation.

Room thermostat input 1 = operation ON (1)/OFF (0).

Room thermostat input 2 = operation ON (1)/OFF (0).

See "14.2. Wiring diagram" on page 41 for connection details.

The operation mode of the unit is subject in the master VRV DX indoor remote controller.

- [6-02] Heater kit option.  
 To activate the heater kit as an option of the HXY(080/125) heat pump, change field setting [6-02]=1 (default value is "0"). From that moment on, the heat pump system will take the heater kit into account whilst deciding operation. When the heater is actually operating, the heater symbol is shown on the remote controller of the hydrobox. Refer to "9. Installing the optional EKBUHAA(6V3/6W1) heater kit" on page 26.

- [6-03] Setting is not applicable.

#### [8] Option setup

- [8-00] User interface temperature control.  
  - [8-00]=0 the unit operates in leaving water temperature control. This is the default setting.
  - [8-00]=1 the unit operates in room temperature control. This means that the user interface is used as room thermostat, so the user interface can be placed in the living room to control the room temperature.
- [8-01] Setting is not applicable.

- **[8-02] Emergency operation.**  
In case of emergency, heating can be provided by the heater kit, not by hydrobox. Emergency mode can be activated by setting [8-02]=1 (default value is "0").  
Activating the emergency mode will stop the heat pump operation of the hydrobox. The pump of the indoor unit will be started, but heating itself is done by the heater kit. If there are no malfunction conditions in leaving or return water thermistors of the hydrobox, the heater kit can start to follow emergency operation.

- **[8-03] Setting is not applicable.**

- **[8-04] Freeze-up prevention.**  
The unit has a freeze-up prevention functionality for which 3 levels can be selected:

- **[8-04]=0** prevention level 0 (default: no prevention).

- **[8-04]=1** prevention level 1.

- **[8-04]=2** prevention level 2.

The freeze-up prevention is only active when the unit is in thermo OFF condition. If prevention level 1 is enabled, the freeze-up prevention will start if the outdoor ambient temperature <4°C and if leaving or return water temperature <7°C. For prevention level 2, the freeze-up prevention will start as soon as the ambient temperature <4°C.

For both cases the pump will operate and if leaving or return water <5°C for 5 minutes the unit will start up to prevent too low temperatures.

### [9] Automatic temperature compensation

If needed, it is possible to adjust some thermistor value of the unit by a correction value. This can be used as countermeasure for thermistor tolerances or capacity shortage.

The compensated temperature (= measured temperature plus compensation value) is then used for controlling the system and will be displayed in the temperature read-out mode.

- **[9-00] Leaving water temperature compensation value for heating operation.**

- **[9-01] Leaving water thermistor auto corrective function.**  
When enabled, this function will take into account the outdoor ambient conditions and correct the measured value which will be used for the logic.

Eg. when the ambient temperature is high during cooling mode, the logic will correct the measured value of the leaving water thermistor to a lower value to take into account influence of high ambient temperatures in the measurement.

- **[9-02] Setting is not applicable.**

- **[9-03] Leaving water temperature compensation value for cooling operation.**

- **[9-04] Setting not applicable.**

### [A] Option setup

- **[A-00] Setting is not applicable.**

- **[A-01] Setting is not applicable.**

- **[A-02] Pump target ΔT setting (heating).**  
Depending on the systems emitter type, the ΔT over the emitter can be modified within the range 3~8°C. Default value is 5°C for fancoil units or floor heating loops.

- **[A-03] Leaving water temperature overshoot/undershoot value**  
This setting makes it possible to set the allowable overshoot (heating)/undershoot (cooling) when operating the unit during leaving water control.

- **[A-04] Setting is not applicable.**

### [b] Settings are not applicable

### [C] Leaving water temperature limits

- **[C-00] Maximum leaving water set point in heating operation.**

- **[C-01] Minimum leaving water set point in heating operation.**

- **[C-02] Maximum leaving water set point in cooling operation.**

- **[C-03] Minimum leaving water set point in cooling operation.**  
If a leaving water temperature of 5°C is wanted, this limit needs to be adjusted. Be aware this can have an impact towards the efficiency of your system.

- **[C-04] Setting is not applicable.**

### [d] Settings are not applicable

### [E] Service mode

- **[E-00] Setting is not applicable.**

- **[E-01] Setting is not applicable.**

- **[E-02] Setting is not applicable.**

- **[E-03] Setting is not applicable.**

- **[E-04] Pump only operation (air purge function)**

When installing and commissioning the unit it is very important to get all air out of the water circuit.

Through this field setting the pump can be operated without actual operation of the unit. By doing so this will enhance the air removal from the unit.

- **[E-04]=0** normal operation of the unit (default)

- **[E-04]=1** low pump speed operation

- **[E-04]=2** high pump speed operation

If you select [E-04]=1 or 2, the unit will activate the air purging function. This function is a helpful feature to get all air removed out of the system (as well in space heating as space cooling).

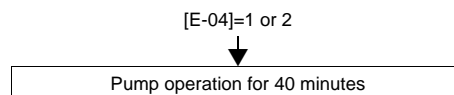

### [F] Option setup

- **[F-00] Pump target ΔT setting (cooling).**

Depending on the systems emitter type, the ΔT over the emitter can be modified within the range 3~8°C. Default value is 5°C for fancoil units or floor heating loops.

- **[F-01] Setting is not applicable.**

- **[F-02] Setting is not applicable.**

- **[F-03] Setting is not applicable.**

- **[F-04] Setting is not applicable.**

## 8.4. Field setting list for Installation Manual

First code	Second code	Setting name	Installer setting at variance with default value				Default value	Range	Step	Unit
			Date	Value	Date	Value				
0	<b>Remote control setup</b>									
	00	User permission level.					2	2-3	1	—
	01	Room temperature compensation value.					0	-5-5	0.5	°C
	02	Not applicable. Do not change the default value.					1	—	—	—
	03	Status: space heating schedule timer mode Method 1=1 / Method 2=0.					1 (ON)	0/1	—	—
	04	Status: space cooling schedule timer mode Method 1=1 / Method 2=0.					1 (ON)	0/1	—	—
1	<b>Settings are not applicable</b>									
	00	Not applicable. Do not change the default value.					1	—	—	—
	01	Not applicable. Do not change the default value.					1:00	—	—	—
	02	Not applicable. Do not change the default value.					0	—	—	—
	03	Not applicable. Do not change the default value.					15:00	—	—	—
2	<b>Automatic setback function</b>									
	00	Status: setback operation.					1 (ON)	0/1	—	—
	01	Setback operation start time.					23:00	0:00-23:00	1:00	hour
	02	Setback operation stop time.					5:00	0:00-23:00	1:00	hour
3	<b>Weather dependent set point</b>									
	00	Low ambient temperature (Lo_A).					-10	-20-5	1	°C
	01	High ambient temperature (Hi_A).					15	10-20	1	°C
	02	Set point at low ambient temperature (Lo_Ti).					40	25-80	1	°C
	03	Set point at high ambient temperature (Hi_Ti).					25	25-80	1	°C
4	<b>Settings are not applicable</b>									
	00	Not applicable. Do not change the default value.					1	—	—	—
	01	Not applicable. Do not change the default value.					Fri	—	—	—
	02	Not applicable. Do not change the default value.					23:00	—	—	—
5	<b>Automatic setback and disinfection set point</b>									
	00	Not applicable. Do not change the default value.					70	—	—	—
	01	Not applicable. Do not change the default value.					10	—	—	—
	02	Leaving water setback temperature.					5	0-10	1	°C
	03	Room setback temperature.					18	17-23	1	°C
	04	Not applicable. Do not change the default value.					0	—	—	—
6	<b>Option setup</b>									
	01	External room thermostat installed.					0 (OFF)	0/2	—	—
	02	Heater kit option.					0 (OFF)	0/1	—	—
	03	Not applicable. Do not change the default value.					0	—	—	—
8	<b>Option setup</b>									
	00	User interface temperature control.					0 (OFF)	0/1	—	—
	01	Not applicable. Do not change the default value.					1	—	—	—
	02	Emergency operation.					0	0/1	—	—
	03	Not applicable. Do not change the default value.					1	—	—	—
	04	Status: freeze-up prevention.					0	0-2	1	—
9	<b>Automatic temperature compensation</b>									
	00	Leaving water temperature compensation value (heating).					0	-2-2	0.2	°C
	01	Leaving water thermistor auto corrective function.					1 (ON)	0/1	1	—
	02	Not applicable. Do not change the default value.					0	—	—	—
	03	Leaving water temperature compensation value (cooling).					0	-2-2	0.2	°C
	04	Not applicable. Do not change the default value.					0	—	—	—



First code	Second code	Setting name	Installer setting at variance with default value				Default value	Range	Step	Unit
			Date	Value	Date	Value				
A	<b>Option setup</b>									
	00	Not applicable. Do not change the default value.					0	—	—	—
	01	Not applicable. Do not change the default value.					0	—	—	—
	02	Pump target $\Delta T$ (heating).					5	3-8	1	—
	03	Allowable overshoot on leaving water.					3	1-5	0.5	°C
04	Not applicable. Do not change the default value.					0	—	—	—	
b	<b>Settings are not applicable</b>									
	00	Not applicable. Do not change the default value.					35	—	—	—
	01	Not applicable. Do not change the default value.					45	—	—	—
	02	Not applicable. Do not change the default value.					1	—	—	—
	03	Not applicable. Do not change the default value.					70	—	—	—
04	Not applicable. Do not change the default value.					70	—	—	—	
C	<b>Leaving water temperature limits</b>									
	00	Set point: heating leaving water maximum temperature.					45	37-45	1	°C
	01	Set point: heating leaving water minimum temperature.					25	25-37	1	°C
	02	Set point: cooling leaving water maximum temperature.					20	18-22	1	°C
	03	Set point: cooling leaving water minimum temperature.					10	5-18	1	°C
04	Not applicable. Do not change the default value.					0	—	—	—	
d	<b>Settings are not applicable</b>									
	00	Not applicable. Do not change the default value.					10	—	—	—
	01	Not applicable. Do not change the default value.					30	—	—	—
	02	Not applicable. Do not change the default value.					15	—	—	—
	03	Not applicable. Do not change the default value.					15	—	—	—
04	Not applicable. Do not change the default value.					40	—	—	—	
E	<b>Service mode</b>									
	00	Not applicable. Do not change the default value.					0	—	—	—
	01	Not applicable. Do not change the default value.					0	—	—	—
	02	Not applicable. Do not change the default value.					0	—	—	—
	03	Not applicable. Do not change the default value.					1	—	—	—
04	Pump only operation.					0	0-25	1	—	
F	<b>Settings are not applicable</b>									
	00	Pump target $\Delta T$ (cooling).					5	3-8	1	—
	01	Not applicable. Do not change the default value.					0	—	—	—
	02	Not applicable. Do not change the default value.					1	—	—	—
	03	Not applicable. Do not change the default value.					10	—	—	—
04	Not applicable. Do not change the default value.					50	—	—	—	

## 8.5. Final check and test run

### 8.5.1. Final check

Before switching on the unit, read the following:

- When the complete installation and all necessary settings have been carried out, be sure that all panels of the unit are closed. If this is not the case, inserting your hand through the remaining openings can cause serious injury due to electrical and hot parts inside the unit.
- The service panel of the switch box may only be opened by a licensed electrician for maintenance purposes.

In order to purge most of the air out of the system perform a pump operation as described below:

- 1 Change field setting [E-04]  
The default value is 0.
  - When changing the setting to 1, the pump will operate at low speed (pump only, the unit will not operate).
  - When changing the field setting to 2, the pump will operate at high speed.
- 2 When air purging is finished, change the field setting back to 0.

It is the responsibility of the installer to make sure that the air is purged out of the unit and system.



#### NOTICE

When using thermostatic radiator valves, make sure to open all valves during air purging operation.

- Be sure that all stop valves are open. (Refer to vacuuming procedure of the outdoor unit)
- Be sure that all water valves are open.

### 8.5.2. System test run

Before you can check test operation of each indoor unit separately, you have to do the system test run. System test run is explained in the installation manual of the outdoor unit. This is an automatic test run which can take some time.

When the system test run is finished, it is possible to do an individual test run as described in "8.5.3. Indoor unit individual test run" on page 24. During this test run, the installer should check indicated items.

### 8.5.3. Indoor unit individual test run



#### INFORMATION

When the indoor units and outdoor unit are powered on for the first time, an initialisation takes place. This will take maximum 12 minutes.

When using the user interface during the initialisation, an malfunction code (E-H) can be displayed.

The installer is obliged to verify correct operation of the indoor and outdoor unit after installation. Therefore a test run must be performed according to the procedures described below. At any time it is possible to check correct operation of space heating/cooling.



#### INFORMATION

- During the first start up of the unit (the first 50 hours of compressor running), it might happen that the noise level of the unit is higher than mentioned in the technical specifications. This is not an abnormal event.
- Start up of the unit in space heating mode is only possible when the outdoor ambient temperature is lower than 20°C.

## Temperature read-out mode

On the user interface, the actual temperatures can be displayed.

- 1 Push and hold the button for 5 seconds.  
The leaving water temperature is displayed (icons and and are blinking).
- 2 Use the and buttons to display:
  - The entering water temperature (icons and are blinking and the icon is flashing slowly).
  - The indoor temperature (icons and are blinking).
  - The outdoor temperature (icons and are blinking).
- 3 Push the button again to leave this mode. If no button is pressed, the user interface leaves the display mode after 10 seconds.

## Procedure for space heating/cooling



#### INFORMATION

The operation mode can not be selected on the hydrobox. The hydrobox follows the operation mode of the master VRV DX Indoor Unit. Refer to outdoor unit manual for further information.

- 1 Check the leaving water and entering water temperature through the user interface read-out mode and write down the displayed values. See "Temperature read-out mode" on page 24.
- 2 Push the button 4 times so the TEST icon will be displayed.
- 3 Perform the test as follows (when no action is performed, the user interface will return to normal mode after 10 seconds or by pressing the button once):  
To test the space heating/cooling operation push the button to start the test run operation.
- 4 The test run operation will end automatically after 30 minutes or when reaching the set temperature. The test run operation can be stopped manually by pressing the button once. If there are misconnections or malfunctions, an malfunction code will be displayed on the user interface. Otherwise, the user interface will return to normal operation.
- 5 To resolve the malfunction codes, see "8.6.2. Malfunction codes list" on page 25.
- 6 Check the leaving water and entering water temperature through the user interface read-out mode and compare them with the values noted with step 1. After 20 minutes of operation an increase/decrease of the values should confirm the space heating/cooling operation.



#### INFORMATION

To display the last resolved malfunction code, push the button 1 time. Push the button again 4 times to return to normal mode.



#### INFORMATION

It is not possible to perform a test run if a forced operation from the outdoor unit is in progress. Should forced operation be started during a test run, the test run will be aborted.

## 8.6. Service and maintenance

In order to ensure optimal operation of the unit, a number of checks and inspections on the unit and the field wiring have to be carried out at regular intervals.

This maintenance should be carried out by your local installer.

To execute maintenance first remove the panels as shown in "7.4.2. To close the indoor unit" on page 16.

### 8.6.1. Maintenance activities



#### DANGER: ELECTRICAL SHOCK

See "7.3.1. Precautions on electrical wiring work" on page 14.



#### WARNING: ELECTRIC SHOCK

- Before carrying out any maintenance or repair activity, always switch off the circuit breaker on the supply panel, remove the fuses or open the protection devices of the unit.
- Do not touch live parts for 10 minutes after the power supply is turned off because of high voltage risk.
- Please note that some sections of the electric component box are hot.
- Make sure you do not touch a conductive section.
- Do not rinse the unit. This may cause electric shocks or fire.



#### Play it safe!

Touch a metal part by hand (such as piping sheet metal) in order to eliminate static electricity and to protect the PCB before performing service.

### Checks

The described checks must be executed at least **once a year** by qualified personnel.

- 1 Pressure relief valve hose (if present)  
Check that the pressure relief valve hose is positioned appropriately to drain the water.
- 2 Water pressure relief valve  
Check for correct operation of the pressure relief valve by turning the red knob on the valve counter-clockwise:
  - If you do not hear a clacking sound, contact your local dealer.
  - In case the water keeps running out of the unit, close both the water inlet and outlet shut-off valves first and then contact your local dealer.
- 3 Switch box  
Carry out a thorough visual inspection of the switch box and look for obvious defects such as loose connections or defective wiring.
- 4 Water pressure  
Check if the water pressure is above 1 bar.  
If necessary add water.
- 5 Water filter  
Clean the water filter.

## 8.6.2. Malfunction codes list

Malfunction code	Failure cause	Corrective action
R1	Failure of writing memory (EEPROM malfunction)	Contact your local dealer.
R6	Malfunction water circuit	<ul style="list-style-type: none"> <li>• Make sure waterflow is possible (open all valves in the circuit).</li> <li>• Force clean water through the unit.</li> <li>• Malfunction of pump.</li> <li>• Malfunction of flowswitch.</li> </ul>
R9	R410A expansion valve malfunction.	<ul style="list-style-type: none"> <li>• Check wiring connections.</li> <li>• Contact your local dealer.</li> </ul>
RA	Heater kit malfunction	<ul style="list-style-type: none"> <li>• Make sure water flow is possible.</li> <li>• Contact your local dealer.</li> </ul>
RJ	Capacity malfunction.	Contact your local dealer.
C1	Bad ACS communication.	Contact your local dealer.
C4	R410A liquid thermistor malfunction.	<ul style="list-style-type: none"> <li>• Check wiring connections.</li> <li>• Contact your local dealer.</li> </ul>
C9	Returning water thermistor malfunction.	<ul style="list-style-type: none"> <li>• Check wiring connections.</li> <li>• Contact your local dealer.</li> </ul>
CR	Heating/cooling leaving water thermistor malfunction.	<ul style="list-style-type: none"> <li>• Check wiring connections.</li> <li>• Contact your local dealer.</li> </ul>
CJ	User interface thermostat thermistor malfunction.	Contact your local dealer.
E3	High pressure malfunction. This malfunction is outdoor unit related. Refer to outdoor unit manual.	<ul style="list-style-type: none"> <li>• Make sure the circuit is filled with water (no air inside, e.g. is the air purge open?)</li> <li>• Make sure water flow is possible (open all valves in the circuit).</li> <li>• Make sure the water filter is not blocked.</li> <li>• Make sure all refrigerant stop valves are open.</li> <li>• Contact your local dealer.</li> </ul>
E4	Low pressure malfunction. This malfunction is outdoor unit related. Refer to outdoor unit manual.	Contact your local dealer.
J1	R410A gas thermistor malfunction.	<ul style="list-style-type: none"> <li>• Check wiring connections.</li> <li>• Contact your local dealer.</li> </ul>
U1	The phases of the power to the unit is reversed. This malfunction is outdoor unit related. Refer to outdoor unit manual.	Exchange two of the three phases (L1, L2, L3) to make a positive phase connection.
U2	Power supply malfunction. This malfunction is outdoor unit related. Refer to outdoor unit manual.	<ul style="list-style-type: none"> <li>• Check wiring connections.</li> <li>• Contact your local dealer.</li> </ul>
UR	Type connection problem.	<ul style="list-style-type: none"> <li>• Wait till initialisation between outdoor module and hydro module finished (after power ON, wait at least 12 minutes).</li> <li>• Contact your local dealer.</li> </ul>
UH	Address malfunction.	Contact your local dealer.

A more detailed malfunction code list can be found in the installation manual of the outdoor unit.

### 8.6.3. Important information regarding the refrigerant used

This product contains fluorinated greenhouse gases covered by the Kyoto Protocol. Do not vent gases into the atmosphere.

Refrigerant type: R410A

GWP<sup>(1)</sup> value: 1975

<sup>(1)</sup> GWP = global warming potential

## 9. Installing the optional EKBUHAA(6V3/6W1) heater kit

The heater kit option can be installed to assist the heat pump during heating operation or to provide primary heating during emergency situations.

Reference is made to the heater kit's installation/operation manual for general installation information. The EKBUHAA can be used together with HXY(080/125) hydrobox unit, when below instructions are followed!

The information in this chapter provides additional information on how to connect the EKBUHAA to the HXY(080/125) hydrobox series.

Items which are mentioned within this chapter replace information which is provided in the EKBUHAA installation/operation manual. Especially information on how to connect hydraulically (general setup) and electrically (wiring) connect EKBUHAA to the HXY(080/125) should be consulted in this chapter.

Hydraulic connection example and electrical connection are explained below.

### Hydraulic connection (general setup)

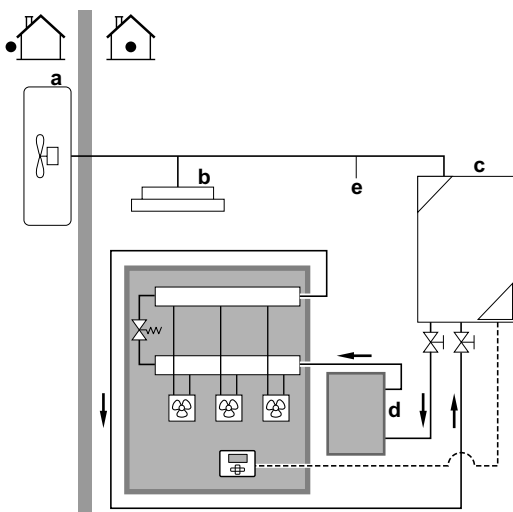

- a Outdoor VRV IV heat pump
- b VRV Direct Expansion (DX) Indoor unit cassette
- c HXY(080/125)
- d Heater kit (EKBUH)
- e Refrigerant piping

### Electric connection

The connection of EKBUHAA to HXY(080/125) hydrobox does not require any optional PCB's to be installed in the HXY(080/125) hydrobox. The EKRP1AHTA should not be used to connect the heater kit to the HXY(080/125) hydrobox.

For details of the electrical connection of the EKBUHAA optional heater kit to the HXY(080/125) hydrobox, refer to "14.2. Wiring diagram" on page 41.

### Field settings related to the backup heater

Refer to "8.3. Field settings" on page 17 how to make field settings for field settings related to the EKBUHAA heater kit.

Other field settings which are explained in the EKBUHAA manual are not applicable in combination with HXY(080/125) hydrobox. The default values should be kept as mentioned in the installation field setting list of the HXY(080/125) hydrobox.

Other information which is explained under field settings in the EKBUHAA manual is not applicable in combination with the HXY hydrobox.

## 10. Hand-over to the user

Once the test run is finished and the unit operates properly, please make sure the following is clear for the user:

- Fill in the installer setting table (see chapter 10) with the actual settings.
- Make sure that the user has the printed documentation and ask him/her to keep it for future reference.
- Explain the user how to properly operate the system and what he/she has to do in case of problems.
- Show the user what jobs he/she has to do in relation to maintenance of the unit.
- Explain the user about energy saving tips as described in the operation manual.

To be filled in by the installer once the test run is finished and the unit operates properly

Tick ✓ when checked	
<input type="checkbox"/>	Explain to the user what system is installed on site. Complete the fill-in below for each unit. The information may be useful for the user in future servicing.

Place of installation:
Model name (see nameplate of the unit)
Optional equipment

<input type="checkbox"/>	Ensure that the user has a printed version of the installation and operation manual and ask him/her to keep it for future reference.
<input type="checkbox"/>	Explain the user how to properly operate the system and what he/she has to do in case of problems.
<input type="checkbox"/>	Show the user what jobs he/she has to do in relation to maintenance of the unit.

Date:
Signature:
Your product was installed by:

## 11. Operation of the unit

Please read chapter 1 and 2 first before consulting this chapter.



### WARNING

Before operating the unit, be sure the installation has been carried out correctly by an installer.

If you feel unsure about the operation, contact your installer for advice and information.

### 11.1. Introduction

#### 11.1.1. General information

The unit is the indoor part of the air to water/air VRV IV heat pump. The unit is designed for wall mounted indoor installation and used for heating/cooling applications. The unit can be combined with (field supply) floor heating/cooling loops or fan coil units.

A user interface with room thermostat functionality is standard supplied with this unit to control your installation.

Refer to chapter "4. About the units and options" on page 5.

#### 11.2. Quick start-up of the unit

In this chapter the step-by-step procedure is explained for starting up space cooling/heating.

The more detailed information of how the unit must be operated is explained in the chapter "11.3. Operating the unit" on page 27.

The quick start-up offers the user the possibility to start up the system before reading the entire manual.

##### 11.2.1. Space cooling/heating operation

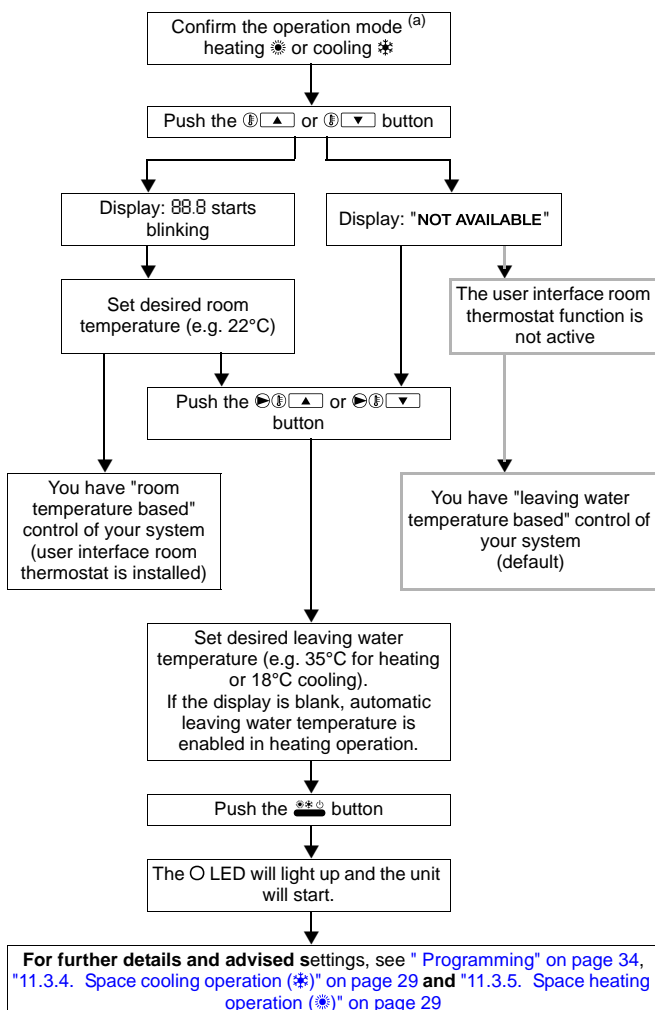

(a) The operation mode can not be selected on the hydrobox. The hydrobox follows the operation mode of the master VRV DX Indoor Unit. Refer to outdoor unit manual for further information

## 11.3. Operating the unit



### CAUTION

- Do not rinse the unit. This may cause electric shock or fire.
- Do not climb, sit or stand on top of the unit.
- Do not place any objects or equipment on the unit top plate.

#### 11.3.1. Operating the user interface

The user interface offers full control over your installation. It can control all heating/cooling applications which vary in capacity, electrical supply and installed equipment (options). Operating the HXY080/125 unit comes down to operating the user interface.



### INFORMATION

It is advised to use the user interface, which includes room thermostat function, delivered with the unit.

This will prevent excessive space heating/cooling and will stop the outdoor and indoor unit when the room temperature is above the thermostat set point. Based on the request from the user there is an immediate feedback to the compressor control which optimizes the performance.

Refer to the typical application examples in the indoor installation manual for more details.



### WARNING

- Never let the user interface get wet. This may cause an electric shock or fire.
- Never press the buttons of the user interface with a hard, pointed object. This may damage the user interface.
- Never inspect or service the user interface yourself, ask a qualified service person to do this.
- Do not rinse the indoor unit. This may cause electric shock or fire.
- Do not climb, sit or stand on top of the unit.
- Do not place any objects or equipment on the unit top plate.

### 11.3.2. Name and function of buttons and icons

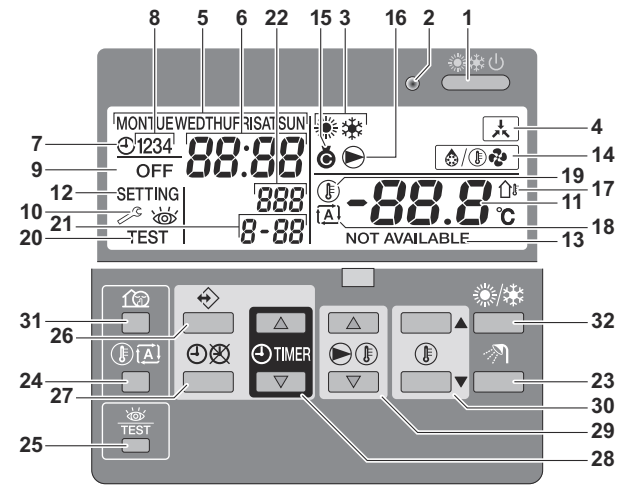

- 1 **ON/OFF BUTTON**

The ON/OFF button starts or stops the space cooling/heating. Pressing the ON/OFF button consecutively too many times may cause malfunction of the system (maximum 20 times per hour).
- 2 **OPERATION LED**

The operation LED is lit during space heating/cooling operation. The LED blinks if a malfunction occurs. When the LED is OFF, space heating/cooling is inactive while the other operation modes can still be active.
- 3 **OPERATION MODE ICONS**

These icons indicate the current operation mode(s): heating (☀) or cooling (❄).
- 4 **EXTERNAL CONTROL ICON**

This icon indicates that the unit is working in a forced operation. As long as this icon is displayed, the user interface cannot be operated or has limited functionality.
- 5 **DAY OF THE WEEK INDICATOR MONTUEWEDTHUFRISATSUN**

This indicator shows the current day of the week. When reading or programming the schedule timer, the indicator shows the set day.
- 6 **CLOCK DISPLAY 88:88**

The clock display shows the current time. When reading or programming the schedule timer, the clock display shows the action time.
- 7 **SCHEDULE TIMER ICON**

This icon indicates that the schedule timer is enabled.
- 8 **ACTION ICONS 1234**

These icons indicate the programming actions for each day of the schedule timer.
- 9 **OFF ICON OFF**

This icon indicates that the OFF action is selected when programming the schedule timer.
- 10 **INSPECTION REQUIRED**

These icons indicate that inspection is required on the installation. Consult your dealer.
- 11 **TEMPERATURE DISPLAY -88.8°C**

The display shows the current temperature of the installation either leaving water temperature or actual room temperature. When changing the room temperature set point, the set point will be flashing for 5 seconds and then return to the actual room temperature.
- 12 **SETTING SETTING**

This icon is displayed whenever the field setting mode is entered.
- 13 **NOT AVAILABLE NOT AVAILABLE**

This icon is displayed whenever a non-installed option is addressed or a function is not available. A function not available can mean insufficient permission level or can mean that a slave user interface is used (see installation manual).

	Permission			
	Master	Slave	level 2	level 3
Operation ON/OFF	✓	✓	✓	✓
Setting the leaving water temperature	✓	✓	✓	—
Setting the room temperature	✓	✓	✓	✓
Weather dependent set point operation ON/OFF	✓	✓	✓	—
Setting the clock	✓	✓	—	—
Programming the schedule timer	✓	—	—	—
Schedule timer operation ON/OFF	✓	—	✓	✓
Field settings	✓	—	—	—
malfunction code display	✓	✓	✓	✓
Test operation	✓	✓	—	—

✓ = operable

- 14 **DEFROST/START UP MODE ICON**

This icon indicates that the defrost/start up mode is active.
- 15 **COMPRESSOR ICON**

This icon indicates that the compressor in the outdoor unit of the system is active.
- 16 **PUMP ICON**

This icon indicates that the circulation pump is active.
- 17 **OUTDOOR TEMPERATURE DISPLAY**

When this icon is flashing, the outdoor ambient temperature is displayed. Refer to "11.3.7. Temperature read-out mode" on page 31 for more information.
- 18 **WEATHER DEPENDENT SET POINT ICON**

This icon indicates that the controller will adapt the leaving water temperature set point automatically, based on the outdoor ambient temperature (during heating operation).
- 19 **TEMPERATURE ICON**

This icon is displayed when the actual room temperature or room temperature set point is shown. The icon is also displayed when the temperature set point is set in schedule timer programming mode. Refer to "11.3.7. Temperature read-out mode" on page 31 for more information.
- 20 **TEST OPERATION ICON TEST**

This icon indicates that the unit runs in test mode.
- 21 **FIELD SET CODE 8-88**

This code represents the code from the field set list. Refer to the "8.3. Field settings" on page 17.
- 22 **MALFUNCTION CODE 888**

This code refers to the malfunction code list and is for service purposes only. Refer to the malfunction code list "8.6.2. Malfunction codes list" on page 25.
- 23 **BUTTON**

This button has no function.
- 24 **WEATHER DEPENDENT SET POINT BUTTON**

This button enables or disables the weather dependent set point function which is available in space heating operation. If the controller is set to permission level 3 (refer to "Field settings" in the installation manual), the weather dependent set point button will not be operable.
- 25 **INSPECTION/TEST OPERATION BUTTON**

This button is used for installation purposes and changing field settings. Refer to "8.3. Field settings" on page 17.
- 26 **PROGRAMMING BUTTON**

This multi-purpose button is used to program the controller. The function of the button depends on the actual status of the controller or on previous actions carried out by the operator.
- 27 **SCHEDULE TIMER BUTTON**

The main function of this multi-purpose button is to enable/disable the schedule timer. The button is also used to set the clock and to program the controller. The function of the button depends on the actual status of the controller or on previous actions carried out by the operator.

## 28 TIME ADJUST BUTTONS and

These multi-purpose buttons are used to adjust the clock, to toggle between temperatures (water inlet/outlet temperature of the unit, outdoor ambient temperature, actual room temperature) and in schedule timer programming mode.

## 29 LEAVING WATER TEMPERATURE ADJUST BUTTONS and

These buttons are used to adjust the leaving water temperature set point in normal operation mode or in schedule timer programming mode.

If the controller is set to permission level 3 (refer to "Field settings" in the installation manual), the leaving water temperature adjust button will not be operable.

In case the weather dependent set point operation is selected, the unit has a floating set point. In this case, the  icon as well as the shift value (in case not zero) will display.

## 30 ROOM TEMPERATURE ADJUST BUTTONS and

These multi-purpose buttons are used to adjust the current room temperature set point in normal operation mode or in schedule timer programming mode.

When changing the room temperature set point, the set point value on the display will be flashing. After 5 seconds the display will show to the actual room temperature.

## 31 BUTTON













This button has no function.

### 11.3.3. Setting up the controller

After initial installation, the user can set the clock and day of the week.

The controller is equipped with a schedule timer that enables the user to schedule operations. Setting the clock and day of the week is required to be able to use the schedule timer.

#### Setting the clock

- 1 Hold down the  button for 5 seconds.  
The clock read-out and the day of week indicator start flashing.
- 2 Use the  and  buttons to adjust the clock.  
Each time the  or  button is pressed, the time will increase/decrease by 1 minute. Keeping the  or  button pressed will increase/decrease the time by 10 minutes.
- 3 Use the  or  button to adjust the day of the week.  
Each time the  or  button is pressed the next or previous day is displayed.
- 4 Press the  button to confirm the current set time and day of the week.  
To leave this procedure without saving, press the  button.  
If no button is pressed for 5 minutes the clock and day of the week will return to their previous setting.



#### INFORMATION

- The clock needs to be set manually. Adjust the setting when switching from summertime to wintertime and vice versa.
- If the controller is set to permission level 2 or 3 (refer to "Field settings" in the installation manual), setting the clock will not be possible.
- A power failure exceeding 2 hours will reset the clock and the day of the week. The schedule timer will continue operation, but with a disordered clock. Therefore it will be needed to correct the clock and the day of the week.

#### Setting the schedule timer

To set the schedule timer, refer to chapter ["11.3.10. Programming and consulting the schedule timer" on page 33](#).

### 11.3.4. Space cooling operation (❄)

Space cooling operation can be controlled in two different ways:

- based on room temperature,
- based on leaving water temperature (default).

The purpose of each operation and how the configuration is done, is explained below.

#### Room temperature control

In this mode, cooling will be activated as required by the room temperature set point. The set point can be set manually or through the schedule timer.









#### INFORMATION

When using room temperature control, space cooling operation based on room temperature will have priority over leaving water control.

Note that it is possible that the leaving water temperature becomes lower than the set point if the unit is controlled by room temperature.





#### Selecting space cooling operation

- 1 Use the  button to switch ON/OFF space cooling (❄).  
Icon ❄ appears on the display as well as the corresponding actual room temperature.  
The operation LED  lights up.
- 2 Use the  and  buttons to set the desired room temperature.  
Temperature range for cooling: 16°C~32°C (room temperature)  
Refer to ["11.3.10. Programming and consulting the schedule timer" on page 33](#) for setup of the schedule timer function.
- 3 Use the  and  buttons to select the leaving water temperature which you want to be used to cool down your system.

#### Leaving water temperature control (default)

In this mode, cooling will be activated as required by the water temperature set point. The set point can be set manually or through the schedule timer.

#### Selecting space cooling operation

- 1 Use the  button to switch ON/OFF space cooling (❄).  
Icon ❄ appears on the display as well as the corresponding water temperature set point.  
The operation LED  lights up.
- 2 Use the  and  buttons to set the desired leaving water temperature.  
Temperature range for cooling: 5°C~20°C (leaving water temperature).

Refer to ["Programming space cooling" on page 34](#), ["Programming space heating" on page 35](#) for setup of the schedule timer function.



#### INFORMATION

- When an external room thermostat is installed, the thermo ON/OFF is determined by the external room thermostat. The user interface is then operated in the leaving control mode and is not functioning as a room thermostat.
- The user interface ON/OFF status always has priority over the external room thermostat!
- Setback operation and weather dependent set point are not available in cooling operation.

### 11.3.5. Space heating operation (☀)

Space heating operation can be controlled in two different ways:

- based on room temperature,
- based on leaving water temperature (default).

The purpose of each operation and how the configuration is done, is explained below.

#### Room temperature control

In this mode, heating will be activated as required by the room temperature set point. The set point can be set manually or through the schedule timer.

## **i** INFORMATION

When using room temperature control, space heating operation based on room temperature will have priority over leaving water control.

Note that it is possible that the leaving water temperature becomes higher than the set point if the unit is controlled by room temperature.

### Selecting space heating operation

- 1 Use the **ON/OFF** button to switch ON/OFF space heating (☀️).  
Icon ☀️ appears on the display as well as the corresponding actual room temperature set point.  
The operation LED ○ lights up.
- 2 Use the **▲** and **▼** buttons to set the desired room temperature.  
Temperature range for heating: 16°C~32°C (room temperature)  
In order to avoid overheating, space heating is not operable when the outdoor ambient temperature rises above a certain temperature (see operation range).  
Refer to "11.3.10. Programming and consulting the schedule timer" on page 33 for setup of the schedule timer function.
- 3 Use the **☀️▲** and **☀️▼** buttons to select the leaving water temperature which you want to be used to heat up your system.

### Automatic setback function

Setback function provides the possibility to lower the room temperature. The setback function can for instance be activated during the night because the temperature demands during night and day are not the same.

## **i** INFORMATION

- Remark that the **Ⓜ** icon will be flashing during setback operation.
- By default the setback function is enabled.
- The setback function can be combined with the automatic weather dependent set point operation.
- Setback function is an automatic daily scheduled function.

The setback function is configured through field settings. Refer to the chapter "8.3. Field settings" on page 17 for a detailed description how to set one or more field settings.

- [2-00] Status: defines whether the setback function is turned ON (1) or OFF (0)
- [2-01] Start time: time at which setback is started
- [2-02] Stop time: time at which setback is stopped
- [5-03] Room setback temperature

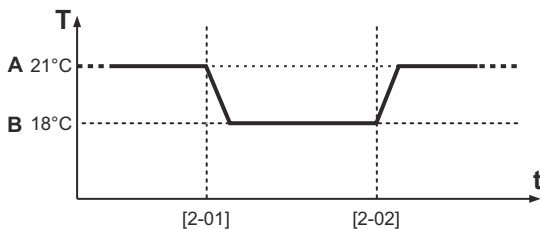

- A Normal room temperature set point
- B Room setback temperature [5-03]
- t Time
- T Temperature

## **i** INFORMATION

- While room temperature setback function is active, leaving water setback operation is also performed.
- Pay attention not to set the setback value too low, especially during colder periods (e.g. winter time). It is possible that the room temperature can not be reached (or it will take a much longer time) because of the big temperature difference.

### Leaving water temperature control (default)

In this mode, heating will be activated as required by the water temperature set point. The set point can be set manually, through the schedule timer or weather dependent (automatic).

### Selecting space heating operation

- 1 Use the **ON/OFF** button to switch ON/OFF space heating (☀️).  
Icon ☀️ appears on the display as well as the corresponding water temperature set point.  
The operation LED ○ lights up.
- 2 Use the **▲** and **▼** buttons to set the desired leaving water temperature.  
Temperature range for heating: 25°C~45°C (leaving water temperature)  
In order to avoid overheating, space heating is not operable when the outdoor ambient temperature rises above a certain temperature (see operation range).

Refer to "User interface schedule timer" for setup of the schedule timer function.



### NOTICE

- When an external room thermostat is installed, the thermo ON/OFF is determined by the external room thermostat. The user interface is then operated in the leaving control mode and is not functioning as a room thermostat.
- The user interface ON/OFF status always has priority over the external room thermostat!

### Selecting weather dependent set point operation

When weather dependent operation is active, the leaving water temperature is determined automatically depending on the outdoor temperature: colder outdoor temperatures will result in warmer water and vice versa. The unit has a floating set point. Activating this operation will result in a lower power consumption than use with a manually fixed leaving water set point.

During weather dependent operation, the user has the possibility to shift up or down the target water temperature by a maximum of 5°C. This shift value is the temperature difference between the temperature set point calculated by the controller and the real set point. E.g. a positive shift value means that the real temperature set point will be higher than the calculated set point.

It is advised to use the weather dependent set point because it adjusts the water temperature to the actual needs for space heating. It will prevent the unit from switching too much between thermo ON operation and thermo OFF operation when using the user interface room thermostat or external room thermostat.



### INFORMATION

During this operation, instead of showing the water temperature set point, the controller shows the shift value which can be set by the user.

- 1 Press the **☀️▲** button 1 time to select weather dependent set point operation (or 2 times when the user interface room thermostat function is used).  
Icon **☀️▲** appears on the display as well as the shift value. The shift value is not shown in case it is 0.
- 2 Use the **▲** and **▼** buttons to set the shift value.  
Range for the shift value: -5°C to +5°C  
Icon **☀️▲** will be displayed as long as the weather dependent set point operation is enabled.
- 3 Press the **☀️▲** button to deactivate weather dependent set point operation.  
The **☀️▲** and **☀️▼** buttons are used to set the leaving water temperature.



Field settings define the parameters for the weather dependent operation of the unit. Refer to the chapter "8.3. Field settings" on page 17 for a detailed description how to set one or more field settings.

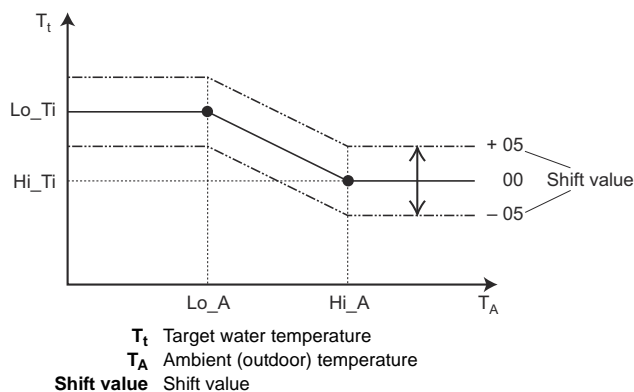

- [3-00] Low ambient temperature (Lo\_A): low outdoor temperature.
- [3-01] High ambient temperature (Hi\_A): high outdoor temperature.
- [3-02] Set point at low ambient temperature (Lo\_Ti): the target outgoing water temperature when the outdoor temperature equals or drops below the low ambient temperature (Lo\_A).
- Note that the Lo\_Ti value should be higher than Hi\_Ti, as for colder outdoor temperatures (i.e. Lo\_A) warmer water is required.
- [3-03] Set point at high ambient temperature (Hi\_Ti): the target outgoing water temperature when the outdoor temperature equals or rises above the high ambient temperature (Hi\_A). Note that the Hi\_Ti value should be lower than Lo\_Ti, as for warmer outdoor temperatures (i.e. Hi\_A) less warm water suffices.



#### INFORMATION

If by mistake the value of [3-03] is set higher than the value of [3-02], the value of [3-03] will always be used.

#### Automatic setback function

Setback function provides the possibility to lower the room temperature. The setback function can for instance be activated during the night because the temperature demands during night and day are not the same.



#### INFORMATION

- Remark that the icon will be flashing during setback operation.
- By default the setback function is enabled.
- The setback function can be combined with the automatic weather dependent set point operation.
- Setback function is an automatic daily scheduled function.

The setback function is configured through field settings. Refer to the chapter "8.3. Field settings" on page 17 for a detailed description how to set one or more field settings.

- [2-00] Status: defines whether the setback function is turned ON (1) or OFF (0)
- [2-01] Start time: time at which setback is started
- [2-02] Stop time: time at which setback is stopped
- [5-02] Leaving water setback temperature (temperature drop)

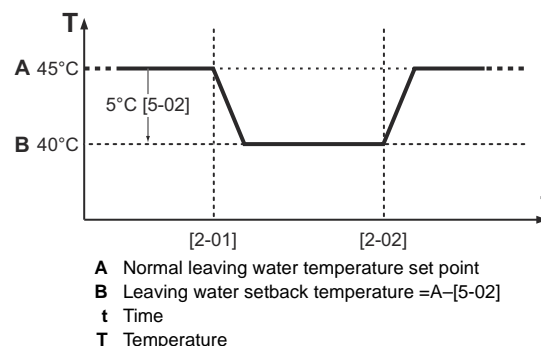

#### 11.3.6. Other operation modes

##### Start up operation ()

During start up, the icon displays, indicating that the heat pump is starting up and is not working in a steady state condition.

##### Defrost operation ()

In space heating operation, freezing of the outdoor heat exchanger may occur due to low outdoor temperature. If this risk occurs, the system goes into defrost operation. After a maximum of 15 minutes of defrost operation, the system returns to space heating operation. During defrost operation, space heating operation is not possible.

#### 11.3.7. Temperature read-out mode

On the user interface, the actual temperatures can be displayed.

- 1 Push and hold the button for 5 seconds.  
 The leaving water temperature is displayed (icons and are blinking and is flashing).
- 2 Use the and buttons to display:
  - The entering water temperature (icons and are blinking and the icon is flashing slowly).
  - The indoor temperature (icons and are blinking).
  - The outdoor temperature (icons and are blinking).
- 3 Push the button again to leave this mode. If no button is pressed, the user interface leaves the display mode after 10 seconds.

### 11.3.8. Schedule timer operation

In schedule timer operation, the installation is controlled by the schedule timer. The actions programmed in the schedule timer will be executed automatically.

The schedule timer is enabled (⊕ icon displayed) or disabled (⊖ icon not displayed) by pressing the ⊕/⊖ button.

#### Space cooling

Refer to "Programming space cooling" on page 34.

4 actions can be programmed, these actions are repeated daily.

The space cooling schedule timer can be programmed in 2 different ways:

- Based on the temperature set point (leaving water temperature and room temperature).
- Based on the ON/OFF instruction.

The desired method is set through field setting. Refer to "8.3. Field settings" on page 17 for a detailed description how to set one or more field settings.

- [0-04] Status: defines whether ON/OFF instruction can be used in the schedule timer for space cooling.

The implementation and meaning of setting [0-04] and schedule settings are the same as for heating operation. See "Operation example: Schedule timer based on temperature set points" on page 32 and "Operation example: Schedule timer based on ON/OFF instruction" on page 33.

For cooling, no setback function is available.

#### INFORMATION

By default space cooling based on temperature set point (method 1) is enabled, so only temperature shifts are possible (no ON/OFF instruction).

### 11.3.9. Space heating

Refer to "Programming space heating" on page 35.

Four actions per day of the week can be programmed, totalling 28 actions.

The space heating schedule timer can be programmed in 2 different ways: based on the temperature set point (both leaving water temperature and room temperature) and based on the ON/OFF instruction.



The desired method is set through field setting. Refer to the chapter "8.3. Field settings" on page 17 for a detailed description how to set one or more field settings.

- [0-03] Status: defines whether ON/OFF instruction can be used in the schedule timer for space heating.

#### INFORMATION

By default space heating based on temperature set point (method 1) is enabled, so only temperature shifts are possible (no ON/OFF instruction).

In the following tables both methods on how to interpret the schedule timer are shown.

Method 1 [0-03]=1 (default) Space heating based on temperature set point <sup>(a)</sup>	
During operation	During schedule timer operation the operation LED is lit continuously.
When pushing the  button	The schedule timer for space heating will stop and will not start again. The controller will be switched off (operation LED will stop working).
When pushing the  button	The schedule timer for space heating will be stopped and will not start again. The schedule timer icon will not be displayed anymore.



(a) For leaving water temperature and/or room temperature

#### Operation example: Schedule timer based on temperature set points

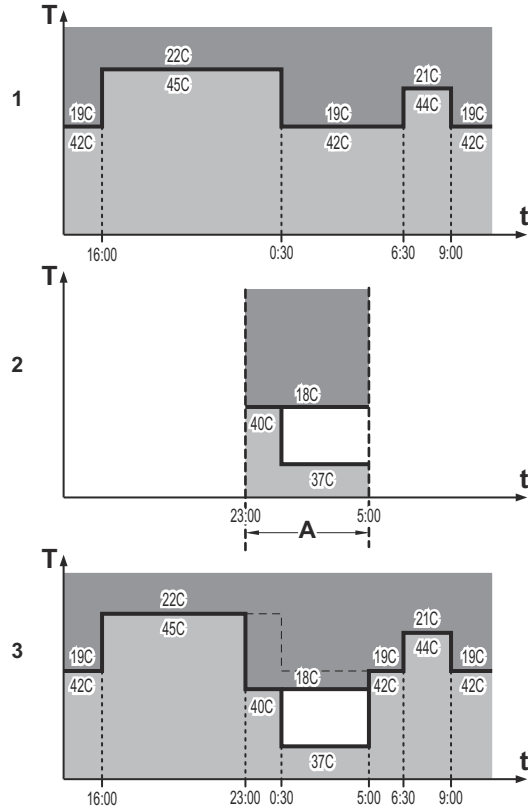
When setback function is enabled, the setback operation will have priority over the scheduled action in the schedule timer.



- 1 Schedule timer
- 2 Setback function
- 3 When both setback function and schedule timer are enabled
- A Setback function
- t Time
- T Temperature set point
- Room temperature
- Leaving water temperature

Method 2 [0-03]=0 Space heating based on ON/OFF instruction	
During operation	When the schedule timer switches space heating OFF, the controller will be switched off (operation LED will stop working).
When pushing the  button	The schedule timer for space heating will stop (when active at that moment) and will start again at the next scheduled ON function. The "last" programmed command overrides the "preceding" programmed command and will remain active until the "next" programmed command occurs. Example: imagine the actual time is 17:30 and actions are programmed at 13:00, 16:00 and 19:00. The "last" programmed command (16:00) overruled the "previous" programmed command (13:00) and will remain active until the "next" programmed command (19:00) occurs. So in order to know the actual setting, one should consult the last programmed command. It is clear that the "last" programmed command may date from the day before. Refer to "Consulting programmed actions" on page 36. The controller will be switched off (operation LED will stop working). However the schedule timer icon will stay displayed.
When pushing the  button	The schedule timer for space heating will be stopped and will not start again. The schedule timer icon will not be displayed anymore.

### Operation example: Schedule timer based on ON/OFF instruction

When setback function is enabled, the setback operation will have priority over the scheduled action in the schedule timer if ON instruction is active. If OFF instruction is active this will have priority over the setback function. At any time the OFF instruction will have the highest priority.

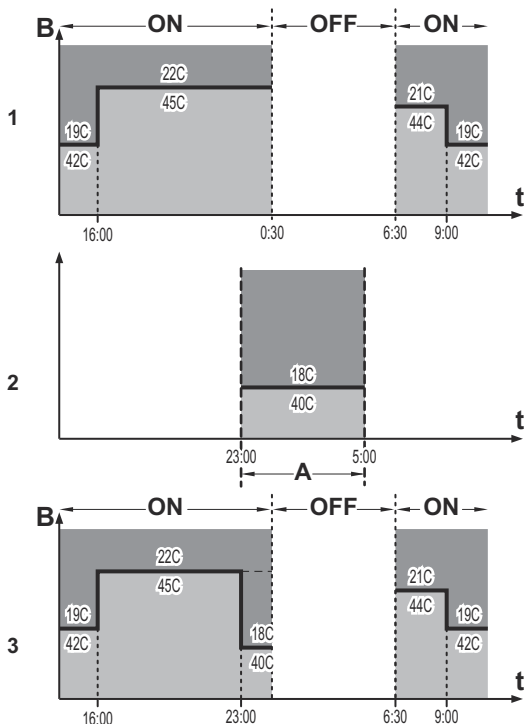

- 1 Schedule timer
- 2 Setback function
- 3 When both setback function and schedule timer are enabled
- A Setback function
- B ON/OFF instruction
- t Time
- T Temperature set point
- Room temperature
- Leaving water temperature

### 11.3.10. Programming and consulting the schedule timer

#### Getting started

Programming the schedule timer is flexible (you can add, remove or alter programmed actions whenever required) and straightforward (programming steps are limited to a minimum). However, before programming the schedule timer, remind:

- Familiarise yourself with the icons and the buttons. You will need them when programming. Refer to "11.3.2. Name and function of buttons and icons" on page 28.
- Fill out the form at the very end of this manual. This form can help you define the required actions for each day.
- Take your time to enter all data accurately.
- Try to program the actions in a chronological way: start with action 1 for the first action and end with the highest number for the last action. This is not a requirement but will simplify the interpretation of the program later.
- If 2 or more actions are programmed for the same day and at the same time, only the first programmed action will be executed.

#### Example:

Programmed actions				Executed actions			
	Time (hour)	Temperature (°C)		Time (hour)	Temperature (°C)		Temperature (°C)
1	18:00	—	OFF	1	06:00	—	21
2	08:00	—	23	2	08:00	—	23
3	06:00	—	21	3	18:00	—	OFF
4	18:00	—	26				

- You can always alter, add or remove the programmed actions later.



#### INFORMATION

- When power returns after a power supply failure, the auto restart function reapplies the user interface settings at the time of the power supply failure (if time is shorter than 2 hours). It is therefore recommended to leave the auto restart function enabled.
- The programmed schedule is time driven. Therefore, it is essential to set the clock and the day of the week correctly.
- Refer to "11.3.3. Setting up the controller" on page 29.
- When the schedule timer is not enabled (Ⓢ icon not displayed), schedule timer actions will not be executed!
- The programmed actions are not stored according to their timing but according to the time of programming. This means that the action that was programmed first gets action number 1, even though it is executed after other programmed action numbers.

## Programming

### Programming space cooling

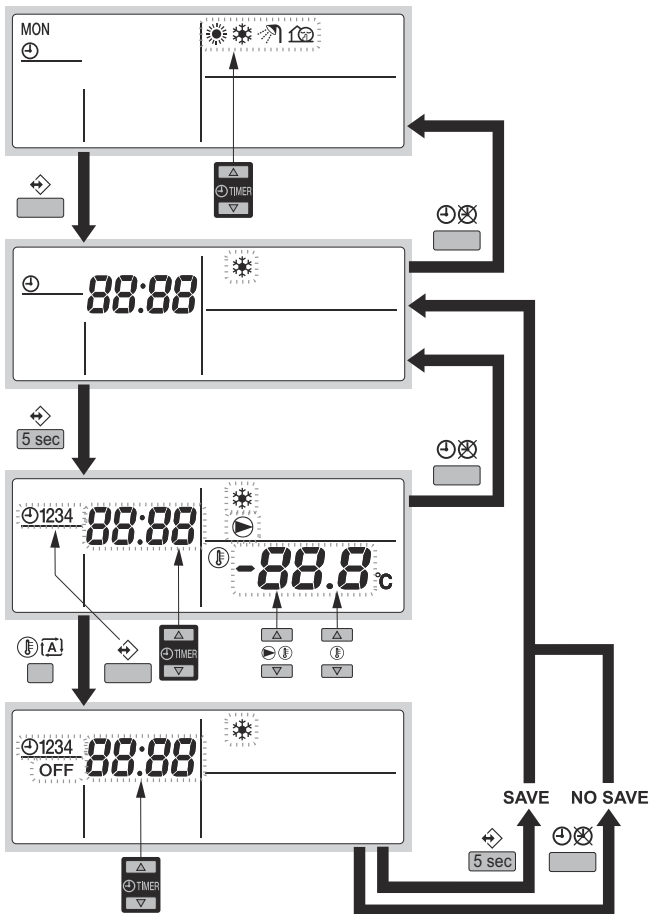

Programming space cooling is carried out as follows:



### INFORMATION

Returning to previous steps in the programming procedure without saving modified settings is done by pressing the button.

- 1 Press the button to enter the programming/consulting mode.
- 2 Select the operation mode you would like to program by means of the and buttons.  
The actual mode is blinking.
- 3 Press the button to confirm the selected mode.  
The time is blinking.
- 4 Consult the action by means of the and buttons.
- 5 Hold down the button for 5 seconds to program the detailed actions.  
The first programmed action appears.
- 6 Use the button to select the action number you would like to program or to modify.
- 7 Use the and buttons to set the correct action time.
- 8 Use the and buttons to set the leaving water temperature.
- 9 Use the and buttons to set the room temperature.
- 10 Use the button to select **OFF** to switch cooling and the user interface off.
- 11 Repeat steps 6 to 10 to program the other actions.  
When all actions have been programmed, make sure that the display shows the highest action number you would like to save.
- 12 Press the button for 5 seconds to store the programmed actions.  
If the button is pressed when action number 3 is displayed, actions 1, 2 and 3 are stored but 4 is deleted.  
You automatically return to step 5.  
By pressing the button several times, you return to previous steps in this procedure and finally return to normal operation.
- 13 You automatically return to step 5, start again to program the following day.

## Programming space heating

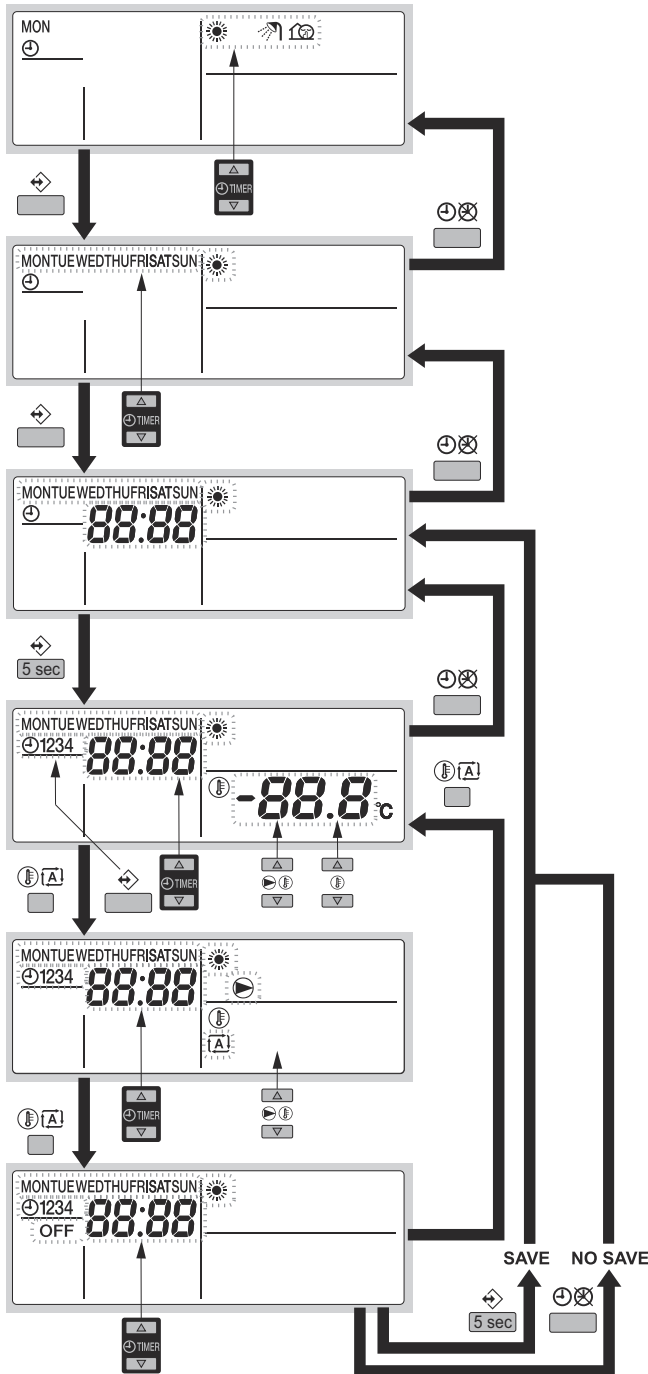

Programming space heating is carried out as follows:



### INFORMATION

Returning to previous steps in the programming procedure without saving modified settings is done by pressing the button.

- 1 Press the button to enter the programming/consulting mode.
- 2 Select the operation mode you would like to program by means of the and buttons.  
The actual mode is blinking.
- 3 Press the button to confirm the selected mode.  
The actual day is blinking.
- 4 Select the day you would like to consult or to program by means of the and buttons.  
The selected day is blinking.
- 5 Press the button to confirm the selected day.
- 6 Hold down the button for 5 seconds to program the detailed actions.  
The first programmed action of the selected day appears.
- 7 Use the button to select the action number you would like to program or to modify.
- 8 Use the and buttons to set the correct action time.
- 9 Use the and buttons to set the leaving water temperature.
- 10 Use the and buttons to set the room temperature.
- 11 Use the button to select:
  - OFF: to switch heating and the user interface off.
  - : to select automatic temperature calculation for leaving water temperature
 Use the and buttons to set the appropriate shift value (refer to "Setting the schedule timer" on page 29 for more information about weather dependent set point).
- 12 Repeat steps 7 to 11 to program the other actions of the selected day.  
When all actions have been programmed, make sure that the display shows the highest action number you would like to save.
- 13 Press the button for 5 seconds to store the programmed actions.  
If the button is pressed when action number 3 is displayed, actions 1, 2 and 3 are stored but 4 is deleted.  
You automatically return to step 6.  
By pressing the button several times, you return to previous steps in this procedure and finally return to normal operation.
- 14 You automatically return to step 6, start again to program the following day.

## Consulting programmed actions

### Consulting space heating/cooling actions

Consulting space cooling heating or space heating is carried out as follows.



#### INFORMATION

Returning to previous steps in this procedure is done by pressing the button.

- 1 Press the button to enter the programming/consulting mode.
- 2 Select the operation mode you would like to consult by means of the and buttons.  
The actual mode is blinking.
- 3 Press the button to confirm the selected mode.  
The actual day is blinking.
- 4 Select the day you would like to consult by means of the and buttons.  
The selected day is blinking.
- 5 Press the button to confirm the selected day.  
The first programmed action of the selected day appears.
- 6 Use the and buttons to consult the other programmed actions of that day.  
This is called the readout mode. Empty program actions (e.g. 4) is not displayed.  
By pressing the button several times, you return to previous steps in this procedure and finally return to normal operation.

### Tips and tricks

#### Programming the next day(s)

After confirming the programmed actions of a specific day (i.e. after pressing the button for 5 seconds), press the button once. You can now select another day by using the and buttons and restart consulting and programming.

#### Copying programmed actions to next day

In space heating program it is possible to copy all programmed actions of a specific day to the next day (e.g. copy all programmed actions from "MON" to "TUE").

To copy programmed actions to the next day, proceed as follows:

- 1 Press the button.  
The actual mode is blinking.
- 2 Use the and buttons to select the mode you want to program.  
The selected mode is blinking.  
You can leave programming by pressing the button.
- 3 Press the button to confirm the selected mode.  
The actual day is blinking.
- 4 Select the day you would like to copy to the next day by means of the and buttons.  
The selected day is blinking.  
You can return to step 2 by pressing the button.
- 5 Press the and buttons simultaneously for 5 seconds.  
After 5 seconds the display will show the next day (e.g. "TUE" if "MON" was selected first). This indicates that the day has been copied.  
You can return to step 2 by pressing the button.

## Deleting one or more programmed actions

Deleting one or more programmed actions is done at the same time as storing the programmed actions.

When all actions for one day have been programmed, make sure that the display shows the highest action number you would like to save. By pressing the button for 5 seconds, you store all actions except those with a higher action number than the one that is displayed.

E.g. when the button is pressed when action number 3 is displayed, actions 1, 2 and 3 are stored but 4 is deleted.

### Deleting a mode

- 1 Press the button.  
The actual mode is blinking.
- 2 Use the and buttons to select the mode you want to delete.  
The selected mode is blinking.
- 3 Press the and button simultaneously for 5 seconds to delete the selected mode.

### Deleting a day of the week

- 1 Press the button.  
The actual mode is blinking.
- 2 Use the and buttons to select the mode you want to delete.  
The selected mode is blinking.
- 3 Press the button to confirm the selected mode.  
The actual day is blinking.
- 4 Select the day you would like to delete by means of the and buttons.  
The selected day is blinking.
- 5 Press the and button simultaneously for 5 seconds to delete the selected day.

### 11.3.11. Operating the optional demand PCB

An optional PCB EKRP1AHTA can be connected to the unit and be used to remotely control the unit

There are 3 inputs that allow

- Remote thermo on - off.
- Remote unit on - off.

For more details about this option kit, refer to the wiring diagram of the unit

### 11.3.12. Operating the optional user interface

If besides the main user interface the optional user interface is installed as well, the main user interface (master) can access all settings while the second user interface (slave) can not access schedule settings and parameter settings.

Refer to the installation manual for more details.

## 11.4. Field settings



### NOTICE

The default values mentioned in "8.3. Field settings" on page 17 are the values from factory. The actual initial values shall be selected according to your application. These values shall be confirmed by your installer.

The unit shall be configured by the installer to match the installation environment (outdoor climate, installed options, etc.) and user demand. However, the field settings mentioned in "8.3. Field settings" on page 17 can be modified to customer preferences. Therefore, a number of so called field settings are available. These field settings are accessible and programmable through the user interface.

Each field setting is assigned a 3-digit number or code, for example [1-03], which is indicated on the user interface display. The first digit [1] indicates the 'first code' or field setting group. The second and third digit [03] together indicate the 'second code'.

A list of all field settings and default values is given under "8.3. Field settings" on page 17. In this same list, we provided 2 columns to register the date and value of altered field settings at variance with the default value.

### 11.4.1. Procedure

To change one or more field settings, proceed as follows.

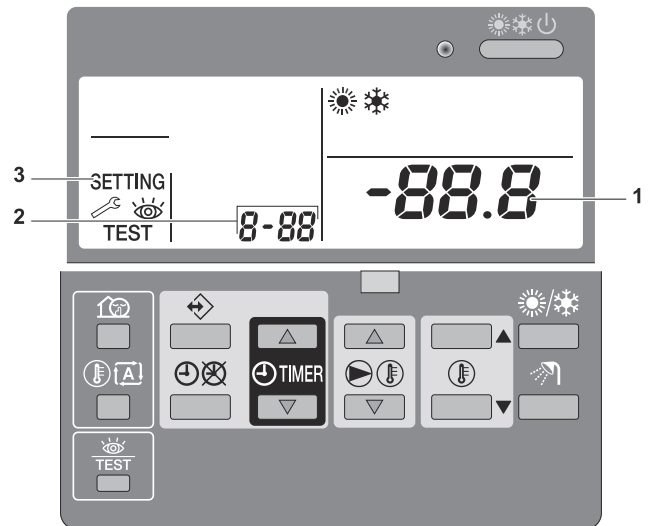

- 1 Press the button for a minimum of 5 seconds to enter FIELD SET MODE.  
The **SETTING** icon (3) will be displayed. The current selected field setting code is indicated **8-88** (2), with the set value displayed to the right **-88.8** (1).
- 2 Press the button to select the appropriate field setting first code.
- 3 Press the button to select the appropriate field setting second code.
- 4 Press the button and button to change the set value of the select field setting.
- 5 Save the new value by pressing the button.
- 6 Repeat step 2 through 4 to change other field settings as required.
- 7 When finished, press the button to exit FIELD SET MODE.



### NOTICE

Changes made to a specific field setting are only stored when the button is pressed. Navigating to a new field setting code or pressing the button will discard the change made.



### INFORMATION

- Before shipping, the set values have been set as shown under "8.3. Field settings" on page 17.
- When exiting FIELD SET MODE, "88" may be displayed on the user interface LCD while the unit initialises itself.



### NOTICE

- When running through the field settings you may notice that there are some more field settings as there are mentioned in the "8.3. Field settings" on page 17. **These field settings are not applicable and may not be changed!**
- For more information about installation related setting, see installation manual of the unit. For settings different from the default value, contact your installer.

## 11.5. Field setting list for Operation Manual

First code	Second code	Setting name	Installer setting at variance with default value				Default value	Range	Step	Unit
			Date	Value	Date	Value				
0	<b>Remote control setup</b>									
	00	Installation related setting <sup>(a)</sup>					2	2-3	1	—
	01	Installation related setting <sup>(a)</sup>					0	-5~5	0.5	°C
	02	Not applicable. Do not change the default value.					1	—	—	—
	03	Status: space heating schedule timer mode Method 1=1 / Method 2=0.					1 (ON)	0/1	—	—
	04	Status: space cooling schedule timer mode Method 1=1 / Method 2=0.					1 (ON)	0/1	—	—
1	<b>Settings are not applicable</b>									
	00	Not applicable. Do not change the default value.					1	—	—	—
	01	Not applicable. Do not change the default value.					1:00	—	—	—
	02	Not applicable. Do not change the default value.					0	—	—	—
	03	Not applicable. Do not change the default value.					15:00	—	—	—
2	<b>Automatic setback function</b>									
	00	Status: setback operation.					1 (ON)	0/1	—	—
	01	Setback operation start time.					23:00	0:00~23:00	1:00	hour
	02	Setback operation stop time.					5:00	0:00~23:00	1:00	hour
3	<b>Weather dependent set point</b>									
	00	Low ambient temperature (Lo_A).					-10	-20~5	1	°C
	01	High ambient temperature (Hi_A).					15	10~20	1	°C
	02	Set point at low ambient temperature (Lo_Ti).					40	25~80	1	°C
	03	Set point at high ambient temperature (Hi_Ti).					25	25~80	1	°C
4	<b>Settings are not applicable</b>									
	00	Not applicable. Do not change the default value.					1	—	—	—
	01	Not applicable. Do not change the default value.					Fri	—	—	—
	02	Not applicable. Do not change the default value.					23:00	—	—	—
5	<b>Automatic setback and disinfection set point</b>									
	00	Not applicable. Do not change the default value.					70	—	—	—
	01	Not applicable. Do not change the default value.					10	—	—	—
	02	Leaving water setback temperature.					5	0~10	1	°C
	03	Room setback temperature.					18	17~23	1	°C
	04	Not applicable. Do not change the default value.					0	—	—	—
6	<b>Option setup</b>									
	01	Installation related setting <sup>(a)</sup>					0 (OFF)	0/2	—	—
	02	Installation related setting <sup>(a)</sup>					0 (OFF)	0/1	—	—
	03	Not applicable. Do not change the default value.					0	—	—	—
8	<b>Option setup</b>									
	00	Installation related setting <sup>(a)</sup>					1 (ON)	0/1	—	—
	01	Not applicable. Do not change the default value.					1	—	—	—
	02	Emergency operation.					0	0/1	—	—
	03	Not applicable. Do not change the default value.					1	—	—	—
	04	Installation related setting <sup>(a)</sup>					0	0~2	1	—
9	<b>Automatic temperature compensation</b>									
	00	Installation related setting <sup>(a)</sup>					0	-2~2	0.2	°C
	01	Installation related setting <sup>(a)</sup>					1 (ON)	0/1	1	—
	02	Not applicable. Do not change the default value.					0	—	—	—
	03	Installation related setting <sup>(a)</sup>					0	-2~2	0.2	°C
	04	Not applicable. Do not change the default value.					0	—	—	—



First code	Second code	Setting name	Installer setting at variance with default value				Default value	Range	Step	Unit
			Date	Value	Date	Value				
A	<b>Option setup</b>									
	00	Not applicable. Do not change the default value.					0	—	—	—
	01	Not applicable. Do not change the default value.					0	—	—	—
	02	Installation related setting <sup>(a)</sup>					5	3-8	1	—
	03	Installation related setting <sup>(a)</sup>					3	1-5	0.5	°C
04	Not applicable. Do not change the default value.					0	—	—	—	
b	<b>Settings are not applicable</b>									
	00	Not applicable. Do not change the default value.					35	—	—	—
	01	Not applicable. Do not change the default value.					45	—	—	—
	02	Not applicable. Do not change the default value.					1	—	—	—
	03	Not applicable. Do not change the default value.					70	—	—	—
04	Not applicable. Do not change the default value.					70	—	—	—	
C	<b>Leaving water temperature limits</b>									
	00	Installation related setting <sup>(a)</sup>					45	37-45	1	°C
	01	Installation related setting <sup>(a)</sup>					25	25-37	1	°C
	02	Installation related setting <sup>(a)</sup>					20	18-22	1	°C
	03	Installation related setting <sup>(a)</sup>					10	5-18	1	°C
04	Not applicable. Do not change the default value.					0	—	—	—	
d	<b>Settings are not applicable</b>									
	00	Not applicable. Do not change the default value.					10	—	—	—
	01	Not applicable. Do not change the default value.					30	—	—	—
	02	Not applicable. Do not change the default value.					15	—	—	—
	03	Not applicable. Do not change the default value.					15	—	—	—
04	Not applicable. Do not change the default value.					40	—	—	—	
E	<b>Service mode</b>									
	00	Not applicable. Do not change the default value.					0	—	—	—
	01	Not applicable. Do not change the default value.					0	—	—	—
	02	Not applicable. Do not change the default value.					0	—	—	—
	03	Not applicable. Do not change the default value.					1	—	—	—
04	Installation related setting <sup>(a)</sup>					0	0-25	1	—	
F	<b>Settings are not applicable</b>									
	00	Installation related setting <sup>(a)</sup>					5	3-8	1	—
	01	Not applicable. Do not change the default value.					0	—	—	—
	02	Not applicable. Do not change the default value.					1	—	—	—
	03	Not applicable. Do not change the default value.					10	—	—	—
04	Not applicable. Do not change the default value.					50	—	—	—	

(a) For more information about installation related settings, see Installation Manual of the indoor unit. For settings different from the default value, contact your installer.

## 12. Maintenance

### 12.1. Important information regarding the refrigerant used

This product contains fluorinated greenhouse gases. Do not vent gases into the atmosphere.

Refrigerant type: R410A  
GWP<sup>(1)</sup> value: 2087,5

<sup>(1)</sup> GWP = global warming potential

Periodical inspections for refrigerant leaks may be required depending on the applicable legislation. Please contact your local dealer for more information.

### 12.2. Maintenance activities

In order to ensure optimal readiness of the unit, a number of checks and inspections on the unit and the field wiring have to be carried out at regular intervals, preferably yearly. This maintenance should be carried out by your local Daikin technician (see installation manual).

The only maintenance which may be required by the operator is:

- Keeping the user interface clean by means of a soft damp cloth.
- Checking if the water pressure indicated on the manometer is above 1 bar.



#### WARNING

If the supply cord is damaged, it must be replaced by the manufacturer, its agent or similar qualified persons in order to avoid hazards.

## 13. Troubleshooting

The guidelines below might help to solve your problem. If you cannot solve the problem, consult your installer.

Possible causes	Corrective actions
No readings on the user interface (blank display)	Check if the main power is still connected to your installation.
One of the malfunction codes appears	Consult your local dealer. Refer to the installation manual or below table for a detailed list of malfunction codes.
The schedule timer does work but the programmed actions are executed at the wrong time. (e.g. 1 hour too late or too early)	Check if the clock and the day of the week are set correctly, correct if necessary.
The schedule timer is programmed but does not work.	In case the ☉ icon is not displayed, push the ☉ button to enable the schedule timer.
Capacity shortage	Consult your local dealer.

### 13.1. Malfunction codes list

When a safety device is activated, the user interface LED will be flashing, and a malfunction code will be displayed.

A list of malfunctions and corrective actions can be found in "8.6.2. Malfunction codes list" on page 25.

Reset the safety by pushing the button.

In case this procedure for resetting the safety is not successful, contact your local dealer.

For other malfunction codes which may be displayed during the system test run or operation, see the installation manual of the outdoor unit.

## 14. Technical Data

### 14.1. Piping diagram

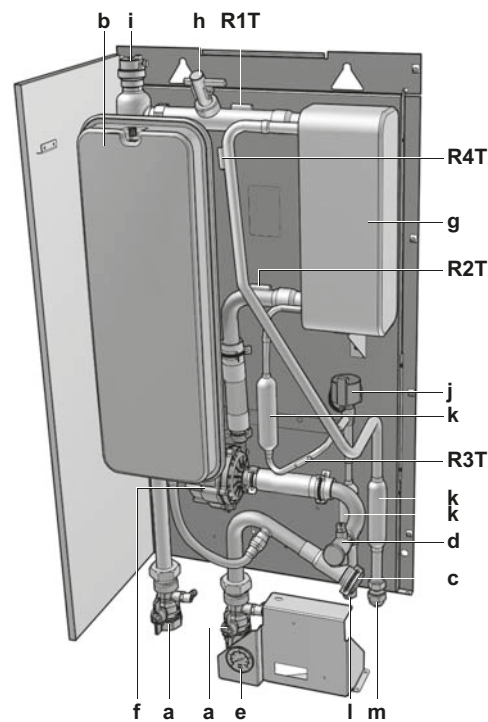
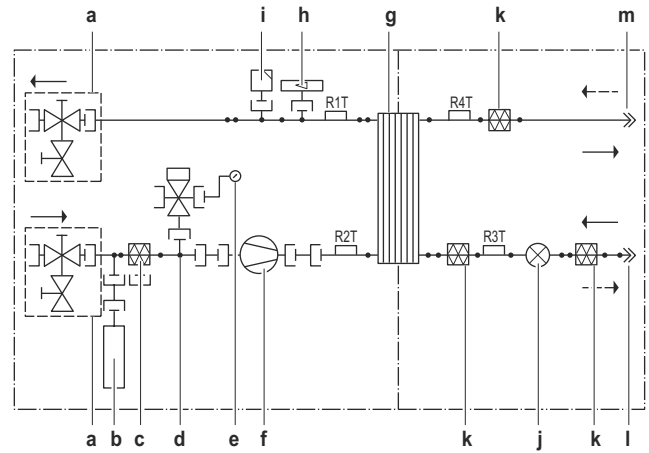

- a Shut off valve with drain/fill valve (field installed)
- b Expansion vessel
- c Water filter
- d Safety valve (3 bar)
- e Manometer
- f Pump (MP1)
- g Plate heat exchanger
- h Flowswitch (S1L)
- i Airpurge
- j Expansion valve (K1E)
- k Refrigerant filter
- l Liquid refrigerant piping
- m Gas refrigerant piping
- R1T Leaving water thermistor
- R2T Return water thermistor
- R3T Liquid thermistor
- R4T Gas thermistor
- Cooling
- -> Heating

## 14.2. Wiring diagram

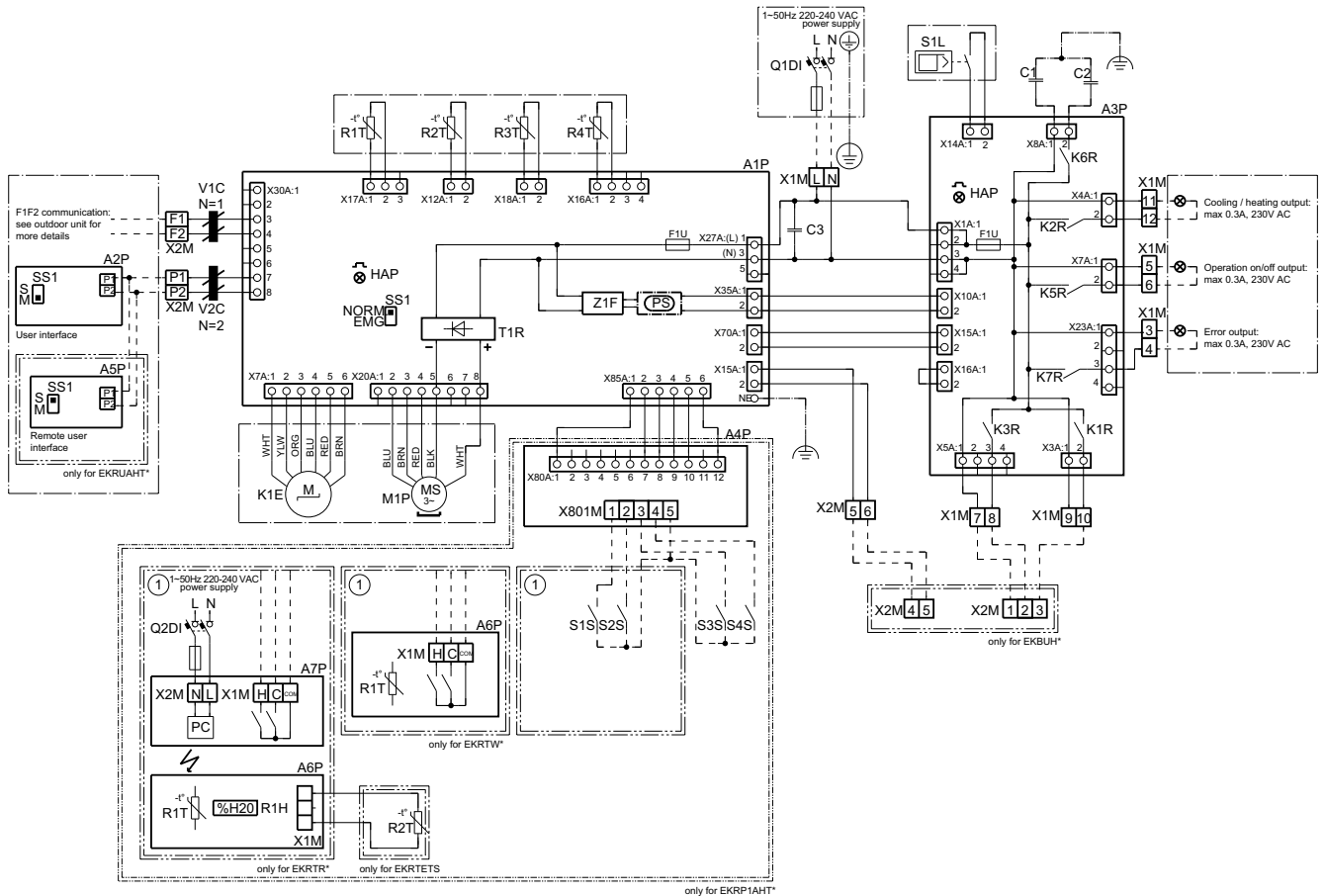

The abbreviations used are listed below:

A1P	.....	Main PCB (master)
A2P	.....	User interface PCB
A3P	.....	Control PCB
A4P	..... *	Demand PCB
A5P	..... *	Remote user interface PCB
A6P	..... *	Thermostat PCB
A7P	..... *	Receiver PCB
C1-C3	.....	Filter capacitor
F1U (A*P)	.....	Fuse (T, 3.15 A, 250 V)
HAP (A*P)	.....	PCB LED
K1E	.....	Electronic expansion valve
K*R (A3P)	.....	PCB relay
M1P	.....	Pump
PC (A7P)	..... *	Power circuit
PS (A1P)	.....	Switching power supply
Q*D1	..... #	Earth leakage circuit breaker
R1H (A6P)	..... *	Humidity sensor
R1T	.....	Leaving water thermistor
R1T (A6P)	..... *	Ambient sensor
R2T	.....	Return water thermistor
R2T	..... *	External sensor (floor or ambient)
R3T	.....	Refrigerant liquid thermistor
R4T	.....	Refrigerant gas thermistor
S1L	.....	Flow switch
S1S	..... #	Thermostat input 1
S2S	..... #	Thermostat input 2
S3S	..... #	Operation ON input
S4S	..... #	Operation OFF input
SS1 (A1P)	.....	Selector switch (emergency) (EMG. = emergency, NORM. = normal)
SS1 (A2P)	.....	Selector switch (main (M)/sub (S))

SS1 (A5P)	..... *	Selector switch (main (M)/sub (S))
T1R	.....	Diode bridge
V1C-V2C	.....	Ferrite core noise filter
X*A (A*P)	.....	PCB connector
X1M	.....	Terminal strip for high voltage field wiring
X2M	.....	Terminal strip for low voltage field wiring
X*M (A*P)	..... *	PCB terminal strip
Z1F (A1P)	.....	Noise filter
	*	Field installed option
	#	Field supplied

### Colours

BLK	.....	Black
BLU	.....	Blue
BRN	.....	Brown
ORG	.....	Orange
RED	.....	Red
WHT	.....	White
YLW	.....	Yellow

### Notes

only for *** power supply	only for *** power supply
Cooling/heating output:	Cooling/heating output:
Operation on/off output:	Operation on/off output:
Error output:	Error output:
F1F2 communication: see outdoor unit for more details	F1F2 communication: see outdoor unit for more details
User interface	User interface
Remote user interface	Remote user interface

### 14.3. Electrical components box

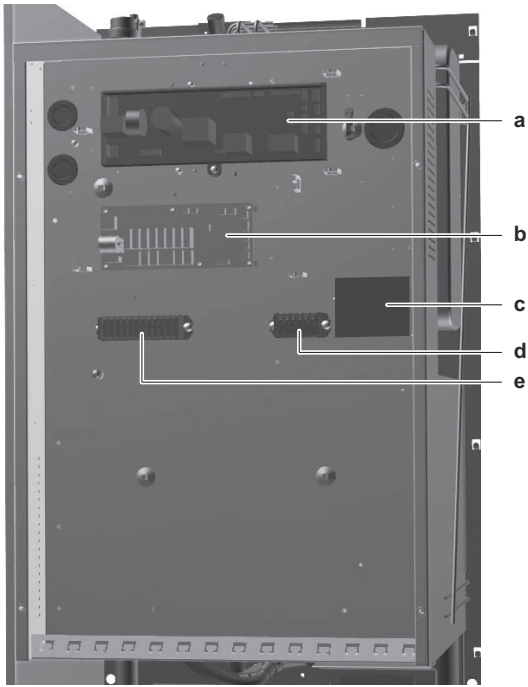

- a A1P: main PCB
- b A3P: control PCB
- c A4P: optional demand PCB
- d X2M: terminal strip
- e X1M: terminal strip

### 14.4. Operation range HXY(080/125)

#### Cooling operation

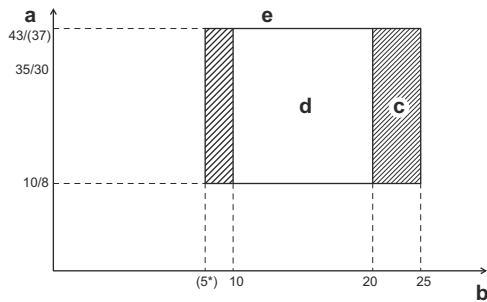

- a Outdoor Ta (°CDB/WB)
- b Indoor (LWE°C)
- c Pull down area
- d Normal operation range

(\*) Depending on operation conditions and only possible after field setting activation (influence on DX cooling (cold draft) and total efficiency).



#### NOTICE

When LWE is selected <18°C; optional drain pan has to be used for Hydrobox.

### Heating operation

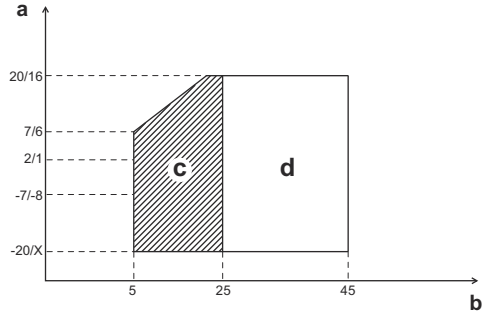

- a Outdoor Ta (°CDB/WB)
- b Indoor (LWC°C)
- c Warming up zone
- d Normal operation range

### 14.5. ESP curve

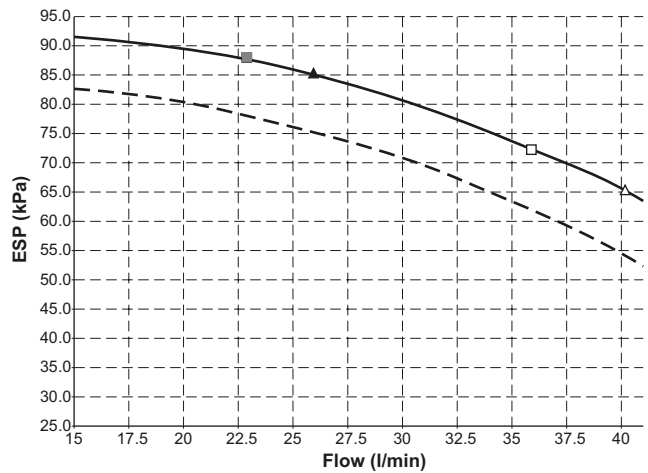

- ESP External Static Pressure
- Flow Waterflow through the unit
- Unit ESP at 4000 rpm ( $\Delta T=5^{\circ}\text{C}$ )
- - - Unit ESP at 3800 rpm ( $\Delta T=8^{\circ}\text{C}$ )
- Maximum ESP if  $\Delta T=5^{\circ}\text{C}$  (heating nominal)
- △ Maximum ESP if  $\Delta T=5^{\circ}\text{C}$  (cooling nominal)

## 14.6. Technical specifications table

	HXY080A8V1B	HXY125A8V1B
<b>Nominal cooling capacity</b>		
• Heating <sup>(a)</sup>	kW	9
• Cooling <sup>(b)</sup>	kW	8
<b>Casing</b>		
• Colour	White	
• Material	Pre-coated sheetmetal	
<b>Dimensions</b>		
• Packing (height x width x depth)	mm	415 x 650 x 1016
• Unit (height x width x depth)	mm	890 x 480 x 344
<b>Weight of unit</b>		
• Machine net weight	kg	44
• Packed machine weight	kg	47
<b>Packing materials</b>		
• Material	Carton / EPS / PP (straps)	
• Weight	kg	2,8
<b>PED</b>		
• Category of unit	Art 3.3 <sup>(c)</sup>	
<b>Pump</b>		
Type	DC motor	
Number of speed	Inverter controlled	
<b>Nominal ESP unit</b>		
• Cooling <sup>(b)</sup>	kPa	88
• Heating <sup>(a)</sup>	kPa	85
<b>Power input</b>		
	W	110
<b>Water side Heat exchanger</b>		
Type	Brazed plate	
Quantity	1	
Minimal water flow rate <sup>(d)</sup>	l/min	15
<b>Nominal water flow rate</b>		
• Cooling <sup>(a)</sup>	l/min	22.9
• Heating <sup>(e)</sup>	l/min	25.8
Insulation material	Elastomeric foam	
<b>Expansion vessel</b>		
Volume	l	10
Maximum water pressure	bar	3
Pre-pressure	bar	1
<b>Water filter</b>		
Diameter perforations	mm	1
<b>Material</b>		
• Body	Copper and brass	
• Filter element	Stainless steel	
<b>Water circuit</b>		
• Piping connections diameter <sup>(f)</sup>	inch	G 1-1/4" (female)
• Safety valve	bar	3
• Manometer	Yes	
• Drain/fill valve	Yes	
• Shut off valves	Yes	
• Flow switch	Yes	
• Air purge valve	Yes	
<b>Refrigerant circuit</b>		
• Gas side diameter	mm	15.9
• Liquid side diameter	mm	9.52
• Piping length restrictions	See installation manual of the outdoor unit and technical engineering data	
<b>Sound level</b>		
• Sound power <sup>(b)</sup>	dBA	
• Sound pressure <sup>(e)</sup>	dBA	
<b>Operation range</b>		
• Ambient space cooling	°C	10~43
• Ambient space heating	°C	-20~20
• Waterside space cooling	°C	(5)10~20
• Waterside space heating	°C	25~45

(a) DB/WB 7°C/6°C - LWC 35°C (DT=5°C)

(b) Tamb 35°C - LWE 18°C (DT=5°C)

(c) Excluded from scope of PED due article 1, item 3.6 of 97/23/EC

(d) Flow switch setting

(e) The sound pressure level is measured at 1 m from the unit. It is a relative value, depending on the distance and acoustic environment.

(f) Value mentioned is connection after ball valves. Connection at unit is G 1-1/4" female.

## 14.7. Electrical specifications table

	HXY080A8V1B	HXY125A8V1B
<b>Power supply</b>		
• Phase	1	
• Frequency	Hz	50
• Voltage	V	220~240
<b>Current</b>		
• Running current	A	2.5
• Z <sub>max</sub>	Ω	—
• Minimum S <sub>sc</sub> value	kVA	—
<b>Fuse</b>		
• Recommended fuse	A	6~16
<b>Voltage range</b>		
• Minimum	V	198
• Maximum	V	264
<b>Wiring connections</b>		
• For power supply	• Quantity of wires	3G
	• Type of wires	Wire type/size has to be selected according to applicable legislation
• Communication cable (F1F2)	• Quantity of wires	2
	• Type of wires	0.75~1.25 mm <sup>2</sup>
• User interface (P1P2)	• Quantity of wires	2
	• Type of wires	0.75~1.25 mm <sup>2</sup>

## 15. Disposal requirements

Dismantling of the unit, treatment of the refrigerant, of oil and of other parts must be done in accordance with the applicable legislation.

Do not try to dismantle the system yourself: the dismantling of the system, treatment of the refrigerant, of oil and other parts must be done by a qualified installer in accordance with the applicable legislation.

Units must be treated at a specialized treatment facility for re-use, recycling and recovery. By ensuring this product is disposed off correctly, you will help to prevent potential negative consequences for the environment and human health. Please contact the installer or local authority for more information.

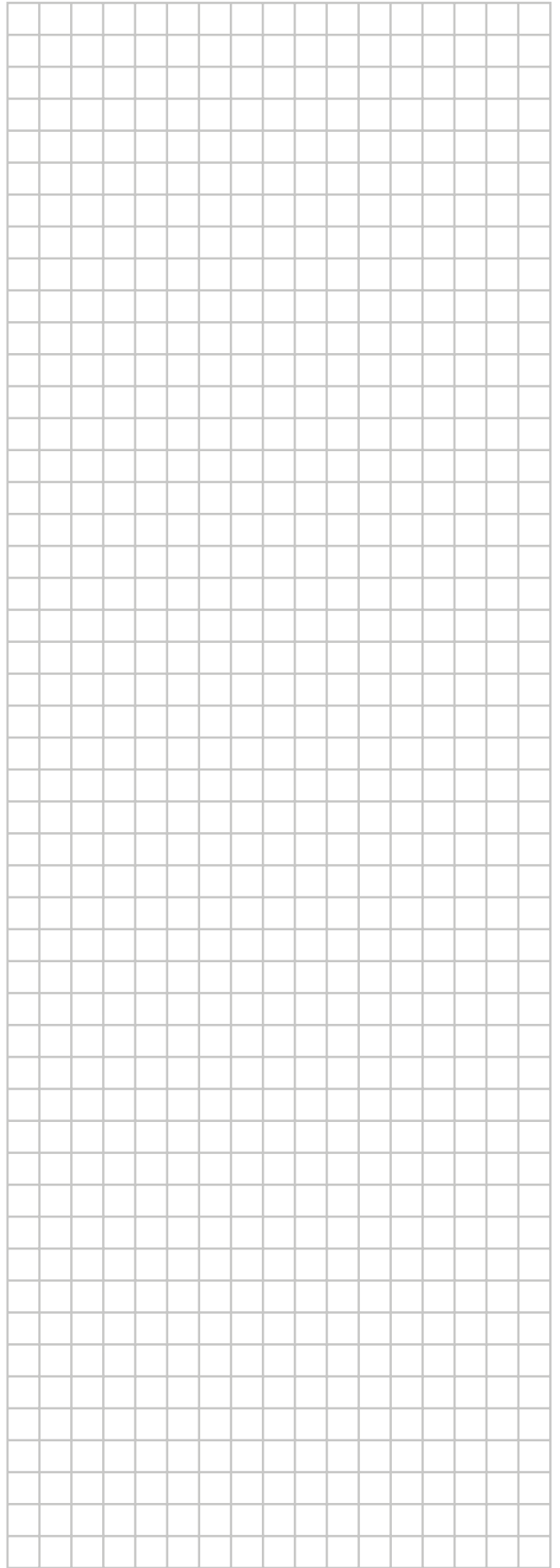
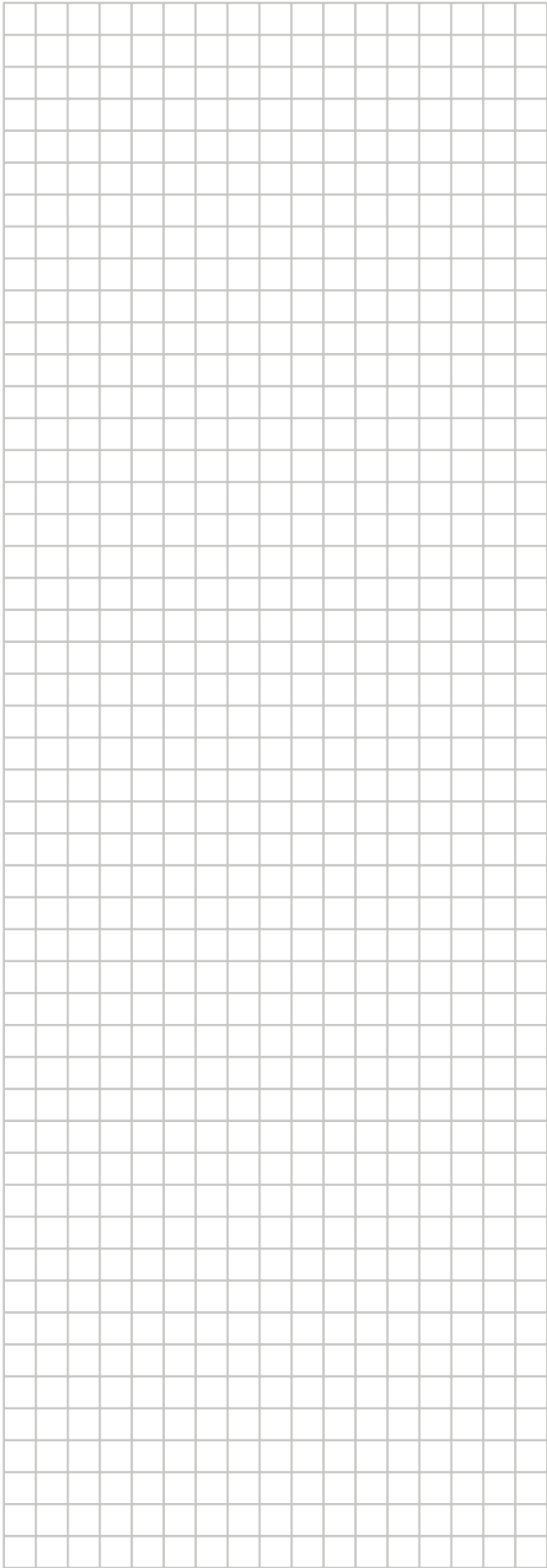

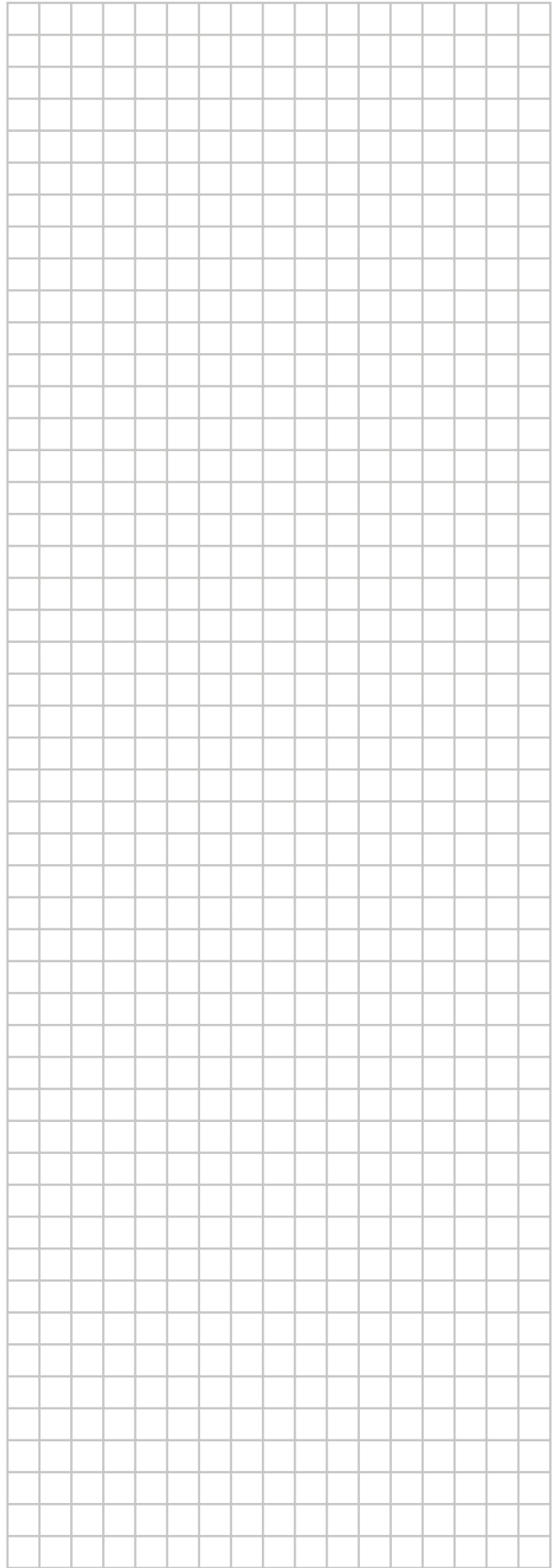
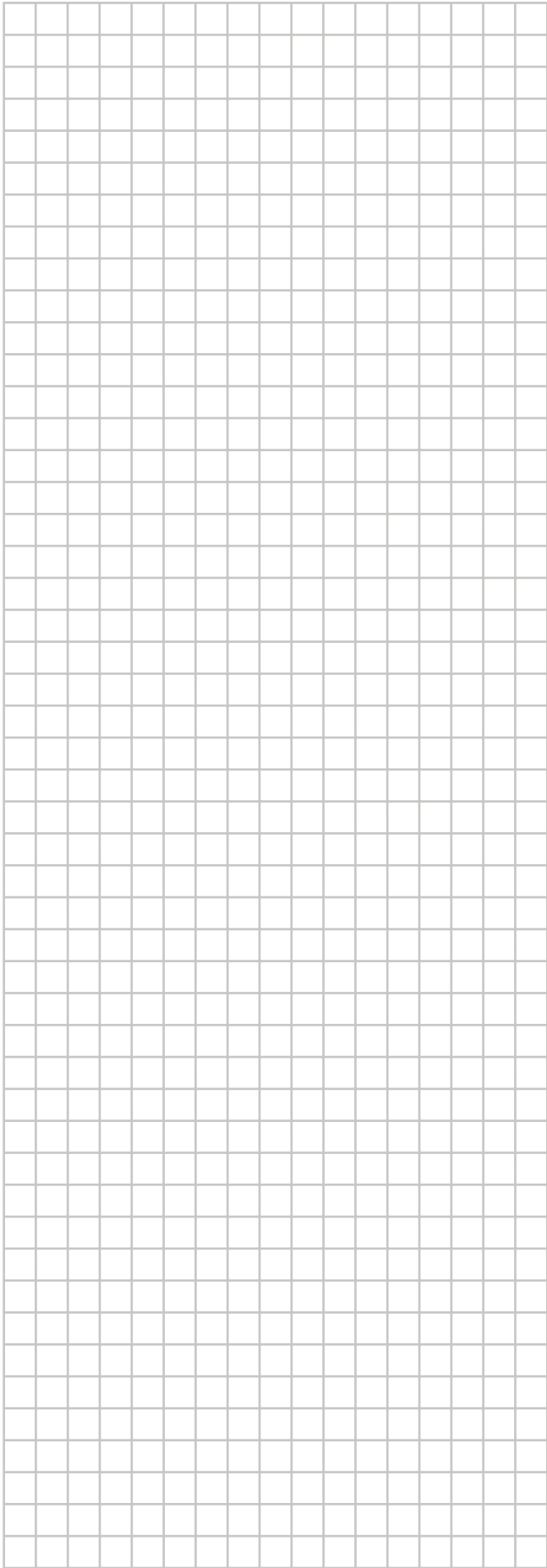

ERC

Copyright 2015 Daikin

**DAIKIN EUROPE N.V.**

Zandvoordestraat 300, B-8400 Oostende, Belgium

4P405267-1 2015.04