

MHI

DATA BOOK

Manual No.'14•KX-DB-220

updated February 05, 2015

VRF INVERTER MULTI-SYSTEM AIR-CONDITIONERS

KXZ Outdoor units

KXZP series

- Single use
FDC224KXZPE1, 280KXZPE1

• Note:
(1)Regarding the indoor unit series, refer to the No.'14•KX-DB-206.

PREFACE

Combination table for KX4, KX6, KXZE1 and KXZPE1 series

Category	Outdoor unit		Connectable remote control	Indoor unit									
				Same series	Same series	Mixed series	Mixed series	Mixed series	Same or Mixed series	Mixed series	Same series		
			3-wire type	RC-E1	KXE4	KXE4(A) KXE4A	KXE4A	KXE4A	KXE4A	KXE4A	KXE4R KXE4BR KXE5R	KXE4R KXE4BR KXE5R	KXE6 KXE6A KXE6B KXE6D KXE6F
Heat pump (2-pipe) systems	FDCA-HKXE4	5HP			YES[D]	YES[D]	NO	NO	NO	NO	NO	NO	NO
	FDCA-HKXE4	8-48HP			NO	YES[D]	NO	NO	NO	NO	NO	NO	NO
	FDCA-HKXE4A FDCA-HKXE4R	5HP 5,6HP			NO	YES[D]	YES[D]*1	NO	NO	YES[D]*1	NO	NO	NO
	FDCA-HKXE4A FDCA-HKXE4R FDCA-HKXE4BR FDCA-HKXE4D	8-48HP 8-48HP 8-48HP 8-48HP			NO	YES[D]	YES[D]	YES[D]	YES[D]	YES[D]	YES[D]	YES[D]	YES[D]
	FDC-KXE6	4,5,6HP			NO	NO	NO	NO	NO	NO	NO	NO	YES[B]*6
	FDC-KXE6	8-48HP			NO	NO	NO	NO	NO	YES[C]	YES[C]	YES[C]	YES[B]
	FDC-KXZE1 FDC-KXZPE1	10-60HP 8,10HP			NO	NO	NO	NO	NO	NO	NO	NO	YES[A]

Note (1) YES: Connectable (See following table in detail), NO: Not connectable

*1 Except FDKA71KXE5R

	Outdoor unit	Connected indoor unit		Dip switch setting of outdoor unit KXZE1/ KXZPE1/ KXE6	Superlink protocol	Limitation
		Same series	Mixed series			
YES[A]*2	KXZE1 KXZPE1	KXE6		II (New)	New (for KXZE1/ KXZPE1/KXE6)	New (for KXZE1/ KXZPE1/KXE6)
YES[B]*2	KXE6	KXE6		II (New)	New (for KXZE1/ KXZPE1/KXE6)	New (for KXZE1/ KXZPE1/KXE6)
YES[C]	KXE6	KXE4 series	KXE6 & KXE4 series	I (Previous)	Previous (for KXE4)	Previous (for KXE4)
YES[D]	KXE4 series	KXE4 series	KXE4 series		Previous (for KXE4)	Previous (for KXE4)

*2 If outdoor unit system (YES [A] or YES [B]) is connected to other outdoor unit systems (YES [C] and/or YES [D]) in one Superlink network, the dip switch of outdoor unit KXZE1/KXZPE1 (YES [A]) or KXE6 of (YES [B]) should be set from II(New) to I(Previous). In this case the Superlink protocol and limitation of outdoor unit system (YES [A] or YES [B]) are switched to Previous (for KX4).

(2) Combination with new central control, PC windows central control and B MS interface unit

		Central control, PC windows central control and BMS interface unit					
		SC-SL1N-E	SC-SL2NA-E	SC-SL4-AE/BE	SC-WGWNB-A/B	SC-LGWNA-A	SC-BGWNA-A/B
YES[A] & YES[B]	Connectable I/U	16	64	128 (128x1)	128 (64x2)*3	96 (48x2)	128 (64x2)*3
	Superlink protocol	New	New	New	New	New	New
	Connectable network	1	1	1	2	2	2
YES[C] & YES[D]	Connectable I/U	16	48	144 (48x3)	96 *4 (48x2)	96 *4 (48x2)	96 *4 (48x2)
	Superlink *5 protocol	Previous	Previous	Previous	Previous	Previous	Previous
	Connectable network	1	1	3	2	2	2

*3 Maximum number of AC Cell is limited up to 96.

In case the number of connected indoor units are more than 96, some AC Cells should hold 2 or more indoor units.

*4 In case of other central control like SC-SLxN-E is connected in the same network, the connectable indoor unit is limited up to 64(32x2).

*5 In case of previous Superlink protocol, the Superlink mode of new central control should be set "Previous".

*6 In case of (YES[A] or YES[B]), previous central control is available to use. But the limitation of connectable indoor unit and so on is complied with the rule of previous Superlink.





CONTENTS

1. GENERAL INFORMATION	1
1.1 Specific features.....	1
1.2 Connectable indoor capacity	7
1.3 How to read the model name	7
1.4 Indoor units table of models	8
1.5 Outdoor units branch pipe set	8
2. OUTDOOR UNIT	9
2.1 Specifications	9
2.2 Exterior dimensions.....	10
2.3 Electrical wiring	11
2.4 Noise level	12
3. RANGE OF USAGE & LIMITATIONS	13
4. PIPING SYSTEM	16
5. SELECTION CHART	17
6. WARNINGS ON REFRIGERANT LEAKAGE	24

1. GENERAL INFORMATION

1.1 Specific features

(1) Series

	112	140	155	224	280	335	280~1680
Current							
	Made in Thailand			Made in China		Made in Thailand	
New							
				Made in Thailand			

 : December 2014

(2) Specifications

Model	Outdoor		FDC224KXE6	FDC224KXZPE1	FDC280KXE6	FDC280KXZPE1
Exterior dimensions	HxWxD	mm	1675x1080x480	1505x970x370	1675x1080x480	1505x970x370
Capacity	Cooling	kW	22.4	22.4	28.0	28.0
	Heating	kW	25.0	22.4	31.5	28.0
COP	EER		4.00	4.00	3.46	3.56
	COP		4.15	4.67	3.84	4.33
Capacity Connection		%	50~150	50~120	50~150	50~120
Number of connectable indoor units			22	8	24	8
Piping length	Furthest indoor unit	m	160	120	160	120
	Total length	m	510	150	510	150
	From first branch	m	90	40	90	40
	Height difference	m	50	30	50	30
	(outdoor unit below)	m	40	30	40	30
	Height difference between indoor	m	18	18	18	18
Refrigerant charge		kg	11.5	8.9	11.5	8.9
Charge less piping length		m	0	0	0	0
Refrigerant piping size	Gas	mm	Φ19.05	Φ19.05	Φ22.22	Φ22.22
	Liquid	mm	Φ9.52	Φ9.52	Φ9.52	Φ9.52
Operating temp	Cooling	°CDB	-15~43	-15~50	-15~43	-15~50
	Heating	°CWB	-20~20	-20~20	-20~20	-20~20

(3) Comparison between current & new

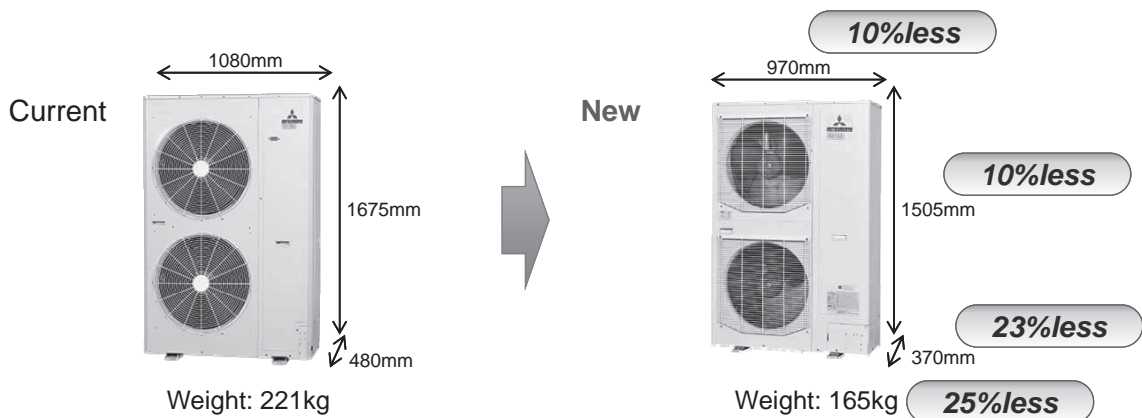

	Current	New
Number of connectable indoor units	1~22units(224) 1~24units(280)	1~8units
Capacity connection	50~150%	50~120%
Total piping length	500m	150m
Piping one way length	160m	120m
Operation range(in cooling)	-15~43°C	-15~50°C
Rated heating capacity	25.0(224) / 31.5(280)	22.4(224) / 28.0(280)

(4) Operation range

in Cooling

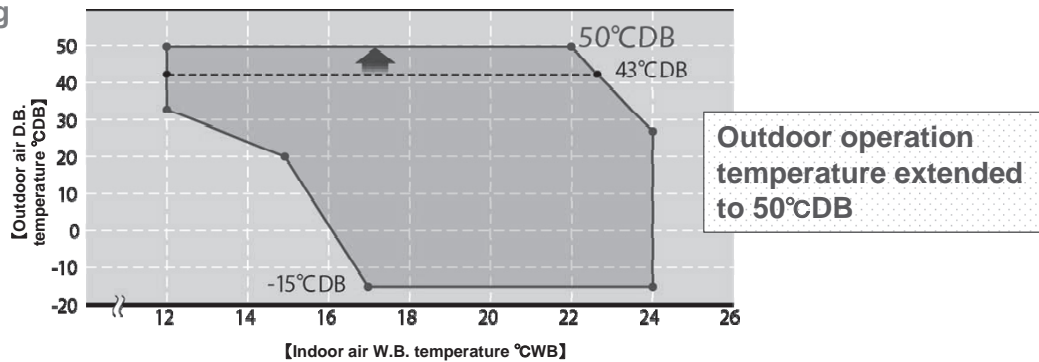

in Heating

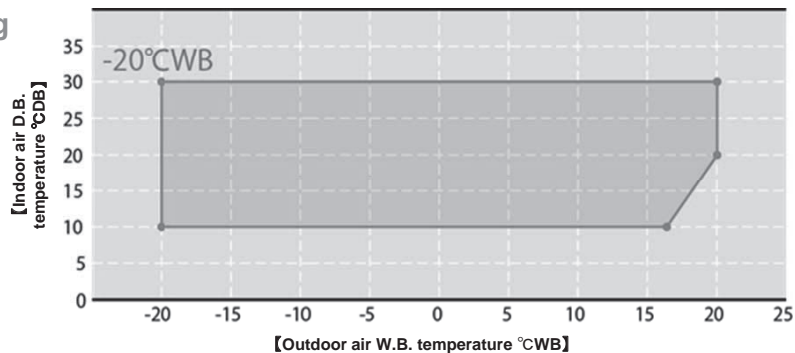

(5) Advanced components

Multiport compressor that achieves high efficiency

The new multiport discharge area in the compressor has optimized pressure control with better balancing. The performance improvement at medium Hz has resulted in higher annual efficiencies.

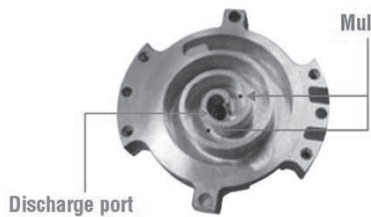

By optimizing pressure adjustment in decompression, the compressor realizes higher efficiency.

Concentrated winding motor achieves "High Output" and "Total Efficiency Improvement"

The newly designed high performance CPU enables high precision optimization for compressor speed, which leads to concentrated winding motor use.

Our product achieves high output and better energy saving effects and in particular improves seasonal efficiency rating.

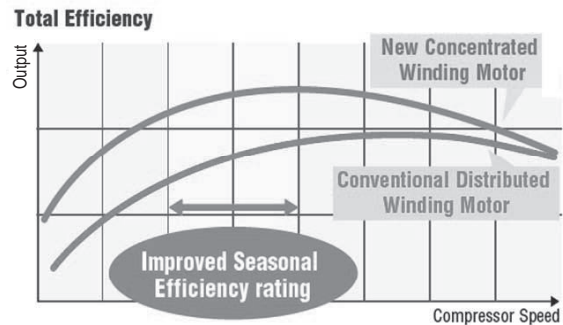

* Above two items are common to PAC(FDC200/250VSA)

(6) Installation piping length

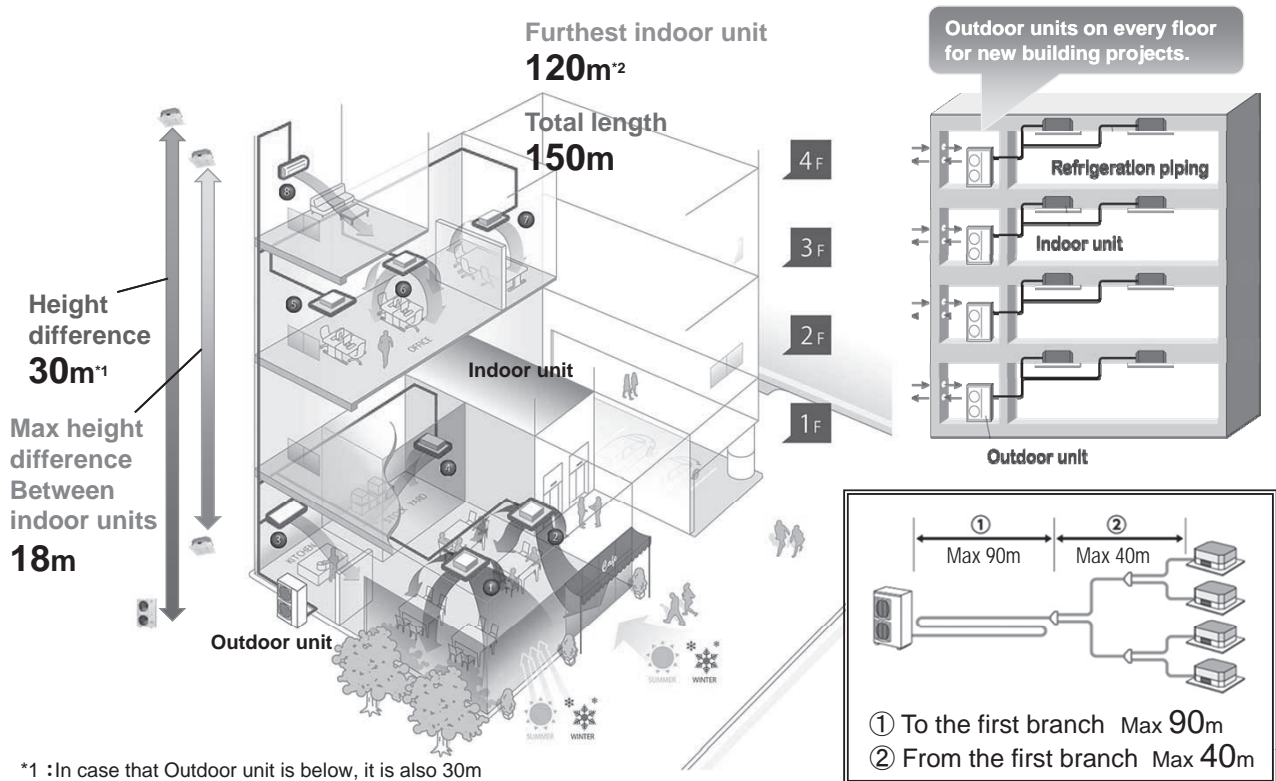

*1 :In case that Outdoor unit is below, it is also 30m

*2 :In case that piping length is over 90m, one size bigger gas line must be used.

(7) Automatic select functions for capacity control

The following 3 items are available for capacity control function.

You can select one item individually or select 2 or 3 items at the same time.

In case of selecting 2 or 3 items, the unit will operate with the most effective function automatically.

A Compressor speed control

It can be set with PWB in the outdoor unit or with a demand control(procure locally).

You can set compressor speed at **100%-80%-60%-40%** before starting operation.

How to set “Compressor speed”

- **1** Set the function of external input (CNS1) to “Capacity control input” by P07 of 7SEG setting.
- **2** Set the Demand rate using SW4-7, 4-8 according the following chart.
- The signal will be input through **3** CNS1. ON/ connected, OFF/ not connected

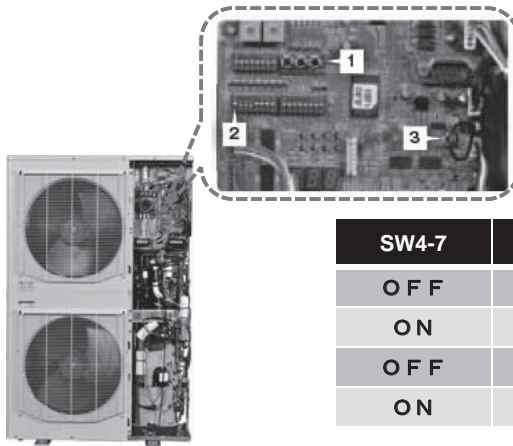

SW4-7	SW4-8	Compressor speed
OFF	OFF	80%
ON	OFF	60%
OFF	ON	40%
ON	ON	0%

B Capacity control timer

It can be set with RC-EX1A.

You can set capacity control with RC-EX1A at 4 times per day a week. Timer setting is available per 5 minutes unit.

“Capacity control”

Capacity control can be set by peak cut function with RC-EX1A for better energy saving. Five-step capacity control is available. (100-80-60-40-0%)

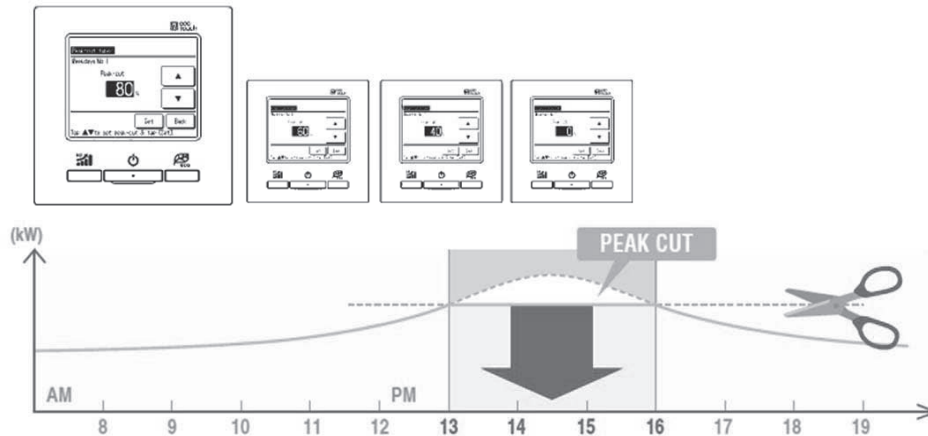

C Silent mode

It can be set with PWB in the outdoor unit or with RC-EX1A.

Considering noise regulation or surrounding circumstances, you can select silent mode among 4 levels of Silent mode「1」&「2」.

Setting combination of silent mode is available by timer function with RC-EX1A.

- Silent mode「1」: priority for capacity
It is effective function during low load operation conditions. This setting may be canceled in the overload conditions.
- Silent mode「2」: priority for silent mode
Regardless of operation conditions, the outdoor unit will keep the operation at the selected sound level.

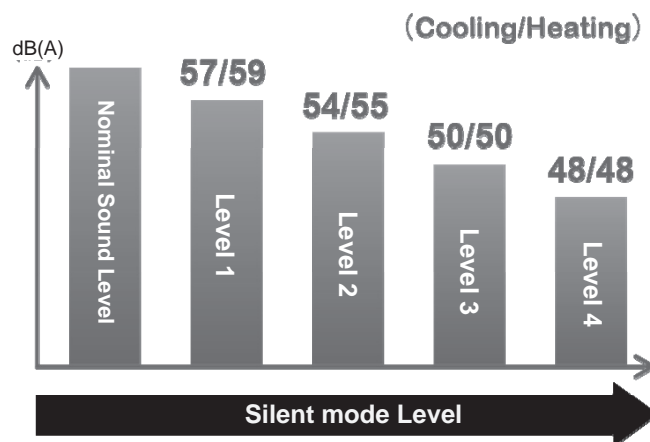

(8) Improved installation items

- Improved freedom of piping layout.

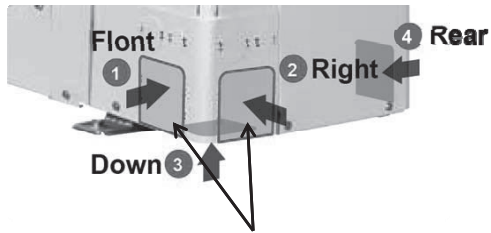

Hole size becomes 120% bigger.

- The wire insertion hole for fall prevention.



- Four handles are located at the same level for easy transference.



- A transparent rain cover is attached as a standard for easy maintenance.

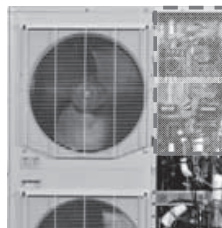

- External static pressure

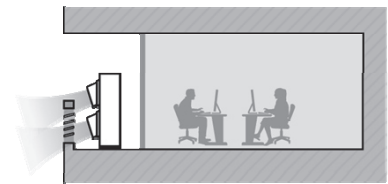

External static pressure is available up to 35 Pa.

- Decreasing nos. of fixing screws of service panel from 5 to 2, installation & service speed was improved.

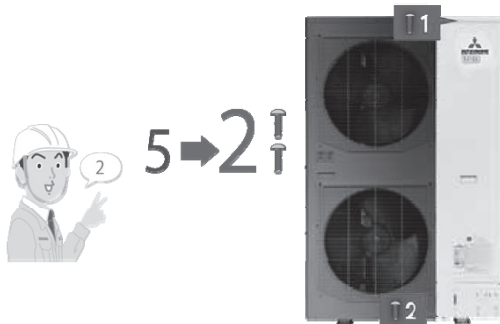

- Thanks to improvement of the control box structure by use of hinged board, service and maintenance were made much easier for inverter components.

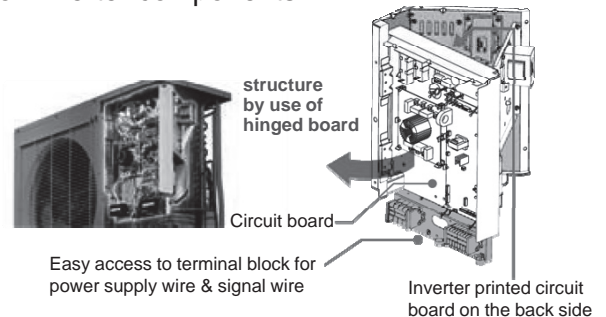

- Meshes of a fan guard were made narrower in order to prevent children from inserting their fingers. (comply with LVD standards)

This new fan guard is common for PAC.

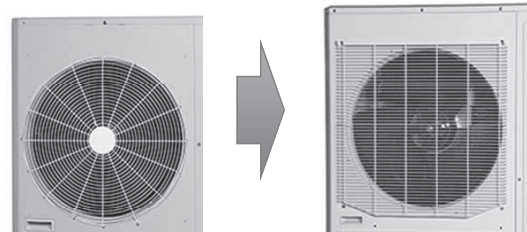

1.2 Connectable indoor capacity

Capacity from 50% to 120% is possible.

Model \ Item	Number of connectable units	Connectable capacity
FDC224KXZPE1	1 to 8	112 — 268
FDC280KXZPE1	1 to 8	140 — 336

Note

For outdoor unit, EN61000-3-2 and EN61000-3-12 are not applicable as consent by the utility company or notification to the utility company is given before usage.

1.3 How to read the model name

(1) Outdoor unit

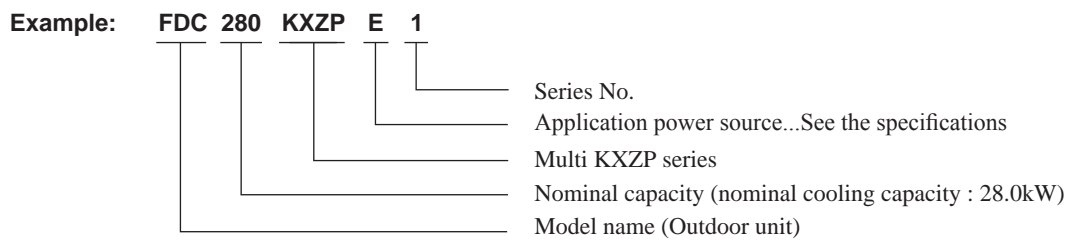

(2) Indoor unit

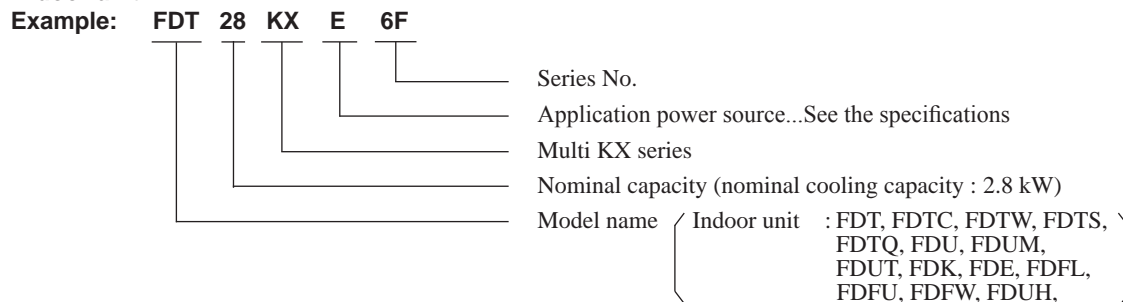

1.4 Indoor units table of models

Model	Capacity													
	15	22	28	36	45	56	71	90	112	140	160	224	280	
Ceiling cassette-4 way type (FDT)			○	○	○	○	○	○	○	○	○			
Ceiling cassette-4 way compact type (FDTC)	○	○	○	○	○	○								
Ceiling cassette-2 way type (FDTW)			○		○	○	○	○	○	○				
Ceiling cassette-1 way type (FDTS)					○		○							
Ceiling cassette-1 way compact type (FDTQ)		○	○	○										
Duct connected-High static pressure type (FDU)					○	○	○	○	○	○	○	○	○	
Duct connected-Low/Middle static pressure type (FDUM)		○	○	○	○	○	○	○	○	○	○			
Duct connected (thin)-Low static pressure type (FDUT)	○	○	○	○	○	○	○							
Wall mounted type (FDK)		○	○	○	○	○	○							
Ceiling suspended type (FDE)				○	○	○	○		○	○				
Floor standing (with casing) type (FDL)							○							
Floor standing (without casing) type (FDL)			○		○	○	○							
Floor standing-2 way type (FDL)			○		○	○								
Duct connected-compact and flexible type (FDUH)		○	○	○										

Note (1) Reference No. of data book : '14-KX-DB-206

1.5 Outdoor units branch pipe set

(a) Branch pipe set (Option)

Total capacity downstream	Branching pipe set
Less than 180	DIS-22-1G
180 or more but less than 371	DIS-180-1G

(b) Header pipe set (Option)

Total capacity downstream	Header set model type	Number of branches
Less than 180	HEAD4-22-1G	4 branches at the most
180 or more but less than 371	HEAD6-180-1G	6 branches at the most

2. OUTDOOR UNIT

2.1 Specifications

Item		Model	FDC224KXZPE1	FDC280KXZPE1	
Power source			3Phase 380-415V 50Hz / 380V 60Hz		
Operation data	Nominal cooling capacity	kW	22.4	28	
	Capacity control	%	-	-	
	Nominal heating capacity	kW	22.4	28	
	Capacity control	%	-	-	
	Power consumption	Cooling	kW	5.6	7.87
		Heating		4.8	6.47
	Max power consumption		13.2	13.7	
	Running current	Cooling	A	9.2/8.5	12.9/11.8
		Heating		7.9/7.3	10.6/9.7
	Inrush current, max current		5, 21	5, 22	
	Power factor	Cooling	%	92	94
		Heating		92	93
	EER	Cooling		4.00	3.56
	COP	Heating		4.67	4.33
	Sound pressure level	Cooling	dB(A)	59	60
Heating		60		63	
Sound power level	Cooling		72	74	
	Heating		73	76	
Silent mode sound pressure level			-	-	
Exterior dimensions (Height x Width x Depth)	mm		1505 x 970 x 370		
Exterior appearance (Munsell color)			Stucco White (4.2Y7.5/1.1) near equivalent		
Net weight	kg		165	165	
Compressor type & Q'ty			GTC5150NC40KFx1		
Compressor motor (Starting method)	kW		Direct line start		
Refrigerant oil (Amount, type)	ℓ		1.45 M-MA32R		
Refrigerant (Type, amount, pre-charge length)	kg		R410A 8.9kg in outdoor unit (Standard charge)		
Heat exchanger			M shape fin & inner grooved tubing		
Refrigerant control			Electronic expansion valve		
Fan type & Q'ty			Propeller fan x2		
Fan motor (Starting method)	W		86 x2 < Direct line start >		
Air flow (Standard)	Cooling	m ³ /min	130	135	
	Heating		130	145	
Available external static pressure	Pa		35		
Shock & vibration absorber			Rubber sleeve(for Compressor)		
Electric heater	W		33 (Crank case heater)		
Safety equipments			Overcurrent protection, Frost protection control Abnormal high pressure protection, Abnormal low pressure protection, Abnormal discharge temperature protection Overload protection for fan motor		
Installation data	Refrigerant piping size (O.D.)	mm	Liquid line: φ 9.52 x 0.8 (3/8")		
			Gas line: φ 19.05 (3/4")x1.0 or φ 22.22 (7/8")x1.0	Gasline: φ 22.22(7/8)x1.0 or φ 25.4 (1")x1.0 or φ 28.58 (11/8")x1.0	
	Connecting method		Liquid : Flare / Gas : Brazing		
	Insulation for piping		Necessary (both Liquid & Gas lines)		
	Refrigerant line (one way) length	m	Max.120m		
Vertical height diff. between O.U. and I.U.	m	Max.30m			
Drain holes		Holes size φ 20 x 3pcs			
Recommended breaker size	A		-		
L.R.A. (Locked rotor ampere)	A		5/5		
IP number			IP24		
Standard accessories			Edging	Connecting pipe, Edging	
Option parts			-		

Note (1) The data are measured at the following conditions.

The pipe length is 7.5m.

Item	Indoor air temperature		Outdoor air temperature		Standards
	DB	WB	DB	WB	
Cooling	27°C	19°C	35°C	24°C	ISO5151-T1,H1
Heating	20°C	-	7°C	6°C	

(2) This air-conditioner is manufactured and tested in conformity with the ISO.

(3) Sound level indicates the value in an anechoic chamber. During operation these values are somewhat higher due to ambient conditions.

(4) Select the breaker size according to the own national standard.

(5) The operation data indicate when the air-conditioner is operated at 380V or 415V.

(6) Use 1/2H pipes having a 1.0mm or thicker wall for φ 19.05 or larger pipes.

(7) This air-conditioner is adapted to RoHS directive.

PCB003Z877 

PCB003Z870

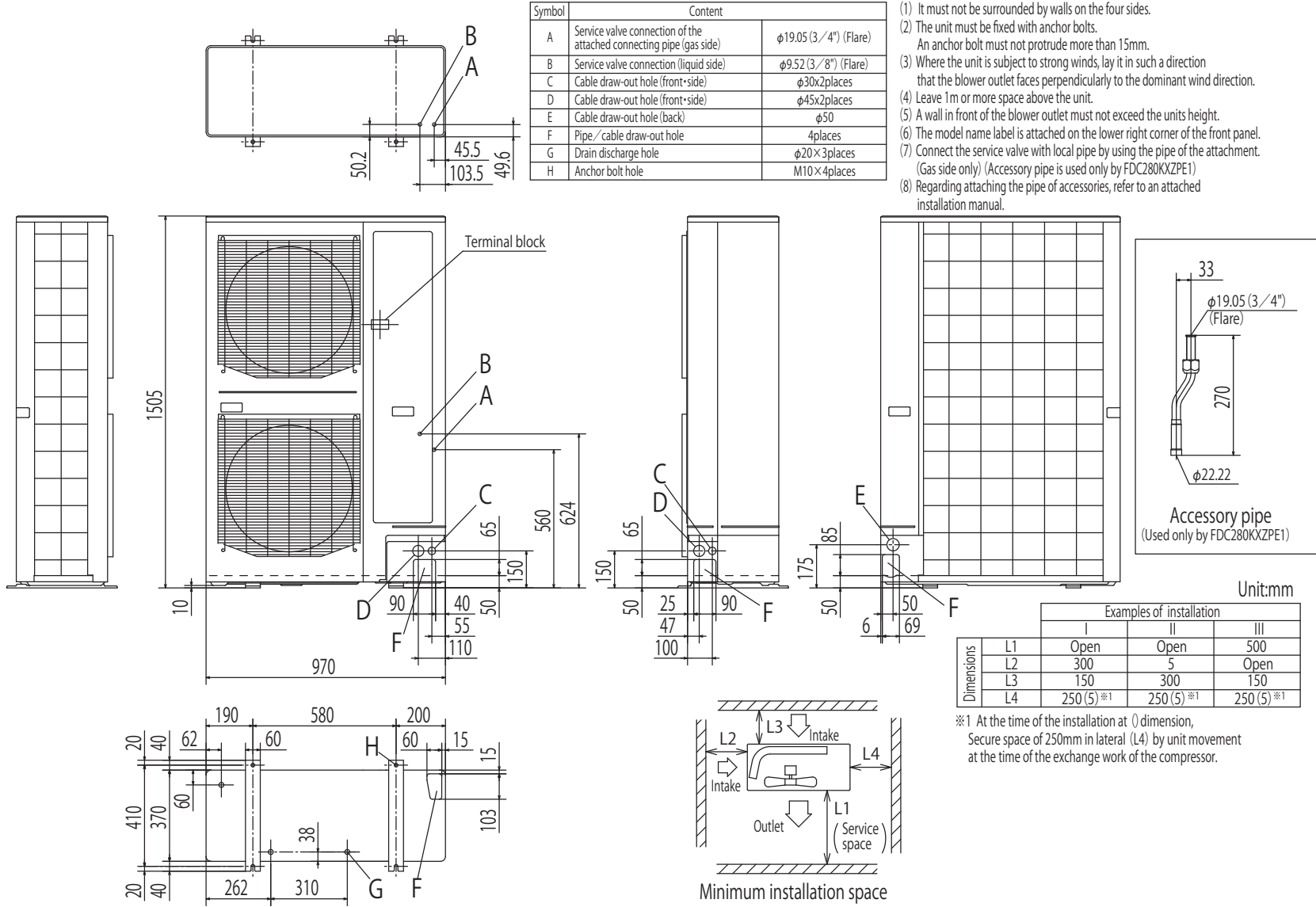

2.2 Exterior dimensions

Models FDC224KXZPE1, 280KXZPE1

2.3 Electrical wiring

Models FDC224KXZPE1, 280KXZPE1

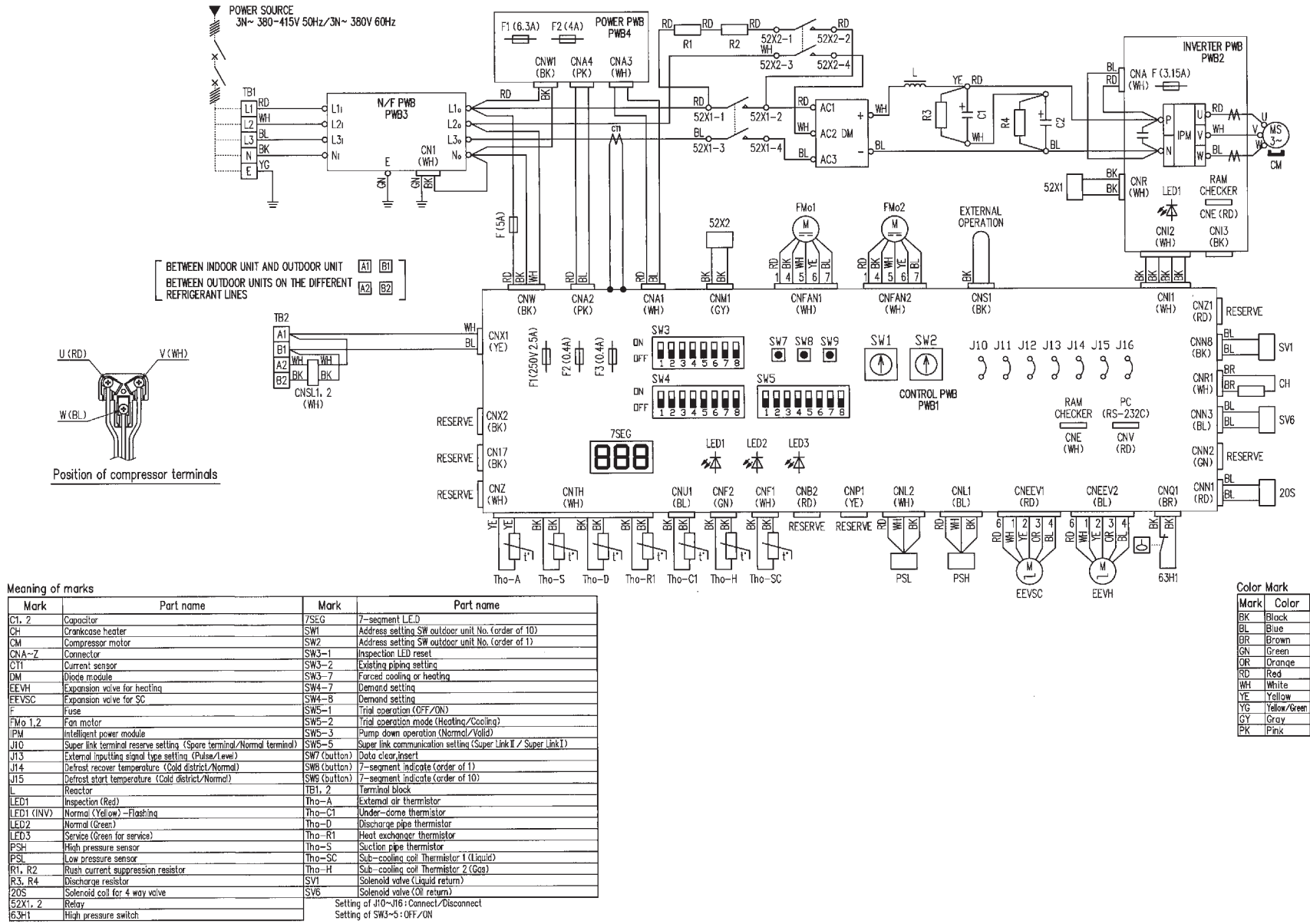

PCB003Z871

2.4 Noise level

Measured based on JIS B 8616

Mike position as highest noise level in position as below

Distance from front side 1m

Height 1m

(1) Sound pressure level

Model FDC224KXZPE1

Noise level 59 dB (A) at cooling
60 dB (A) at heating

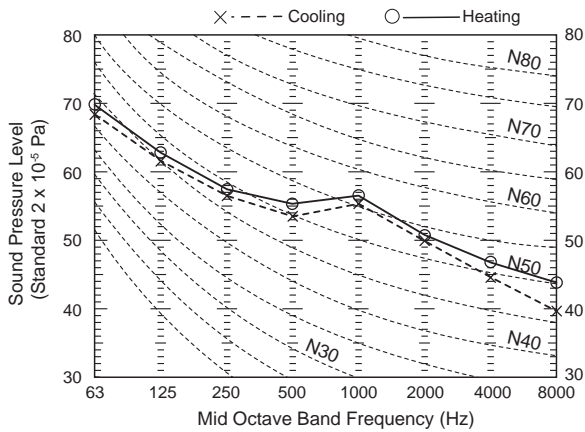

Model FDC280KXZPE1

Noise level 60 dB (A) at cooling
63 dB (A) at heating

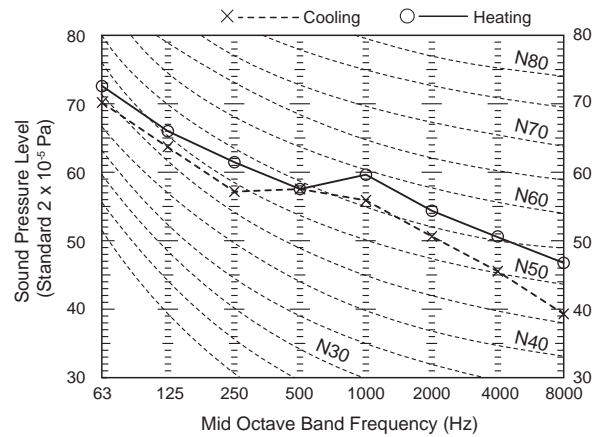

(2) Sound power level

Model FDC224KXZPE1

Noise level 72 dB (A) at cooling
73 dB (A) at heating

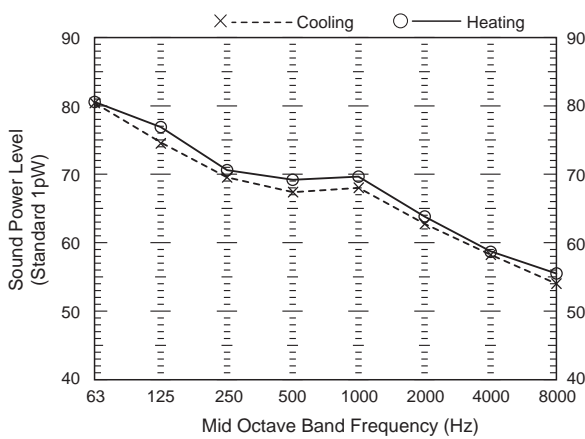

Model FDC280KXZPE1

Noise level 74 dB (A) at cooling
76 dB (A) at heating

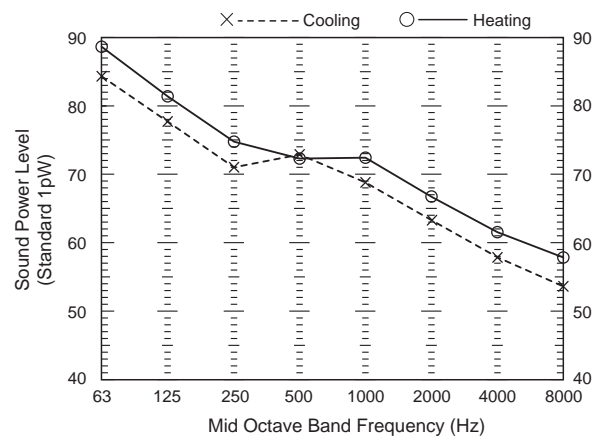

3. RANGE OF USAGE & LIMITATIONS

• Single use

System		FDC224KXZPE1	FDC280KXZPE1
Indoor air temperature (Upper, lower limits)		Refer to page 15	
Outdoor air temperature (Upper, lower limits)			
Indoor units that can be used in combination	Number of connected units	1 to 8 units	1 to 8 units
	Connectable capacity	112 - 268	140 - 336
Total piping length		150m or less	
Main pipe length		90m or less	
Single direction piping length		Actual length : 120m or less	
Allowable pipe length from the first branching		40m or less	
Elevation difference between the first branching point and the indoor unit		18m or less	
Difference in height between indoor and outdoor units	Outdoor unit is higher	30m or less	
	Outdoor unit is lower	30m or less	
Difference in the elevation of indoor units in a system		18m or less	
Indoor unit atmosphere (behind ceiling) temperature and humidity (Only models FDT, FDTC, FDTW, FDTs, FDTQ, FDU, FDUM, FDUT, FDUH)		Dew point temperature 28 °C or less, relative humidity 80% or less (FDE, FDK, FDFL, FDFU, FDFW : Dew point temperature 23°C or less, relative humidity 80% or less)	
Compressor stop/start frequency	1 cycle time	5 min or more (from stop to stop or from start to start)	
	Stop time	3 min or more	
Power source voltage	Voltage fluctuation	Within ±10% of rated voltage	
	Voltage drop during start	Within -15% of rated voltage	
	Phase unbalance	Within 3%	

Allowable length of refrigerant piping, height difference between indoor and outdoor unit

(1) Branch pipe System (Branch piping used)

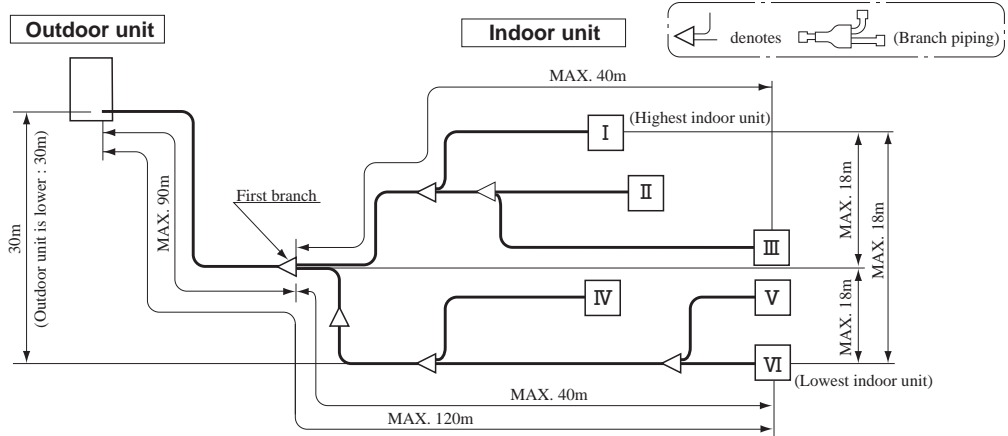

(2) Header System (Header used)

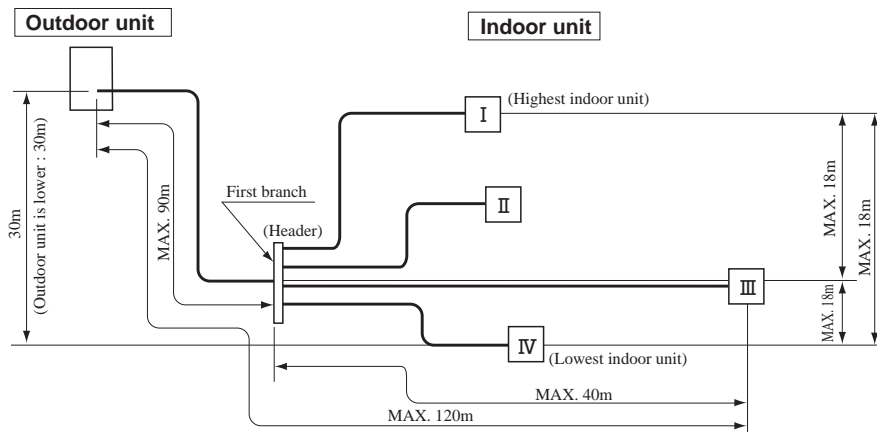

(3) Mixed System (Branch piping and header used)

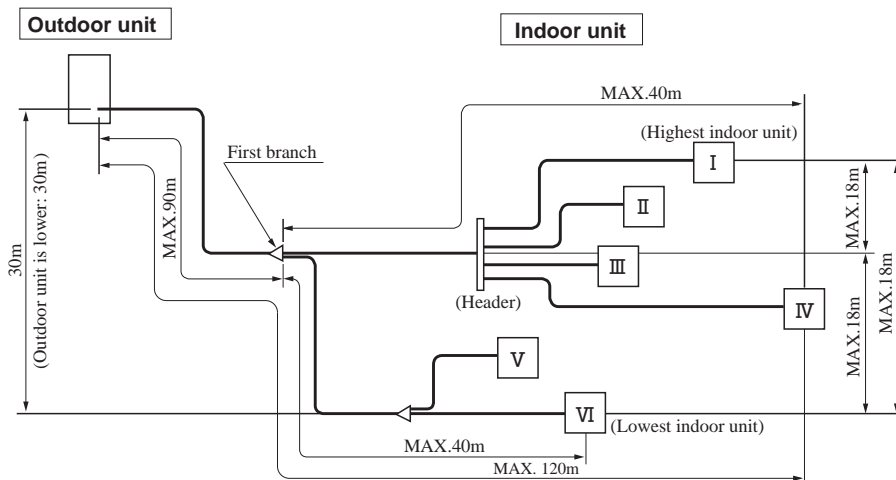

Note (1) A branch piping system cannot be connected after a header system.

Important When the additional refrigerant quantity is over 9.1kg, please separate the refrigerant line.

Operating temperature range

Cooling operation

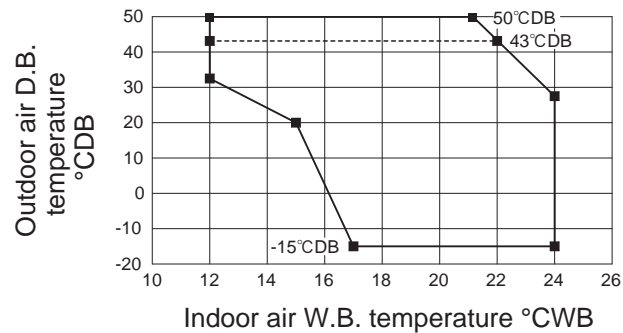

Broken line :
In case of usage of existing pipe
and limit the high pressure.

Heating operation

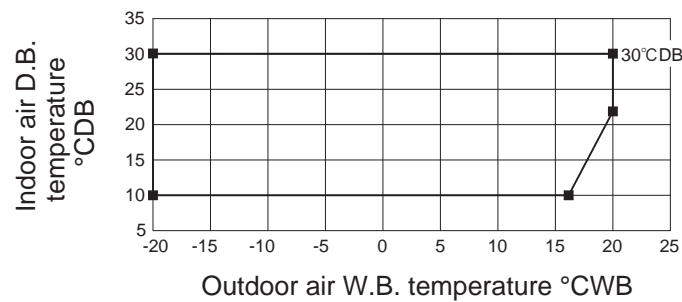

“CAUTION” Cooling operation under low outdoor air temperature conditions

KXZ models can be operated in cooling mode at low outdoor air temperature condition within above temperature range. However in case of severely low temperature conditions if the following precaution is not observed, it may not be operated in spite of operable temperature range mentioned above and cooling capacity may not be established under certain conditions.

[Precaution]

In case of severely low temperature condition

- 1) Install the outdoor unit at the place where strong wind cannot blow directly into the outdoor unit.
- 2) If there is no installation place where can prevent strong wind from directly blowing into the outdoor unit, prepare a windbreak fence or something like that locally in order to divert the strong wind from the outdoor unit.

[Reason]

Under the low outdoor air temperature conditions of -5°C or lower, if strong wind directly blow into the outdoor unit, the outdoor heat exchanger temperature will drop, even though the outdoor fan is stopped by outdoor fan control. This makes high and low pressures to drop as well. This low pressure drop makes the indoor heat exchanger temperature to drop and will activate anti-frost control at indoor heat exchanger at frequent intervals, that cooling operation may not be established for any given time.

4. PIPING SYSTEM

Models FDC224KXZPE1, 280KXZPE1

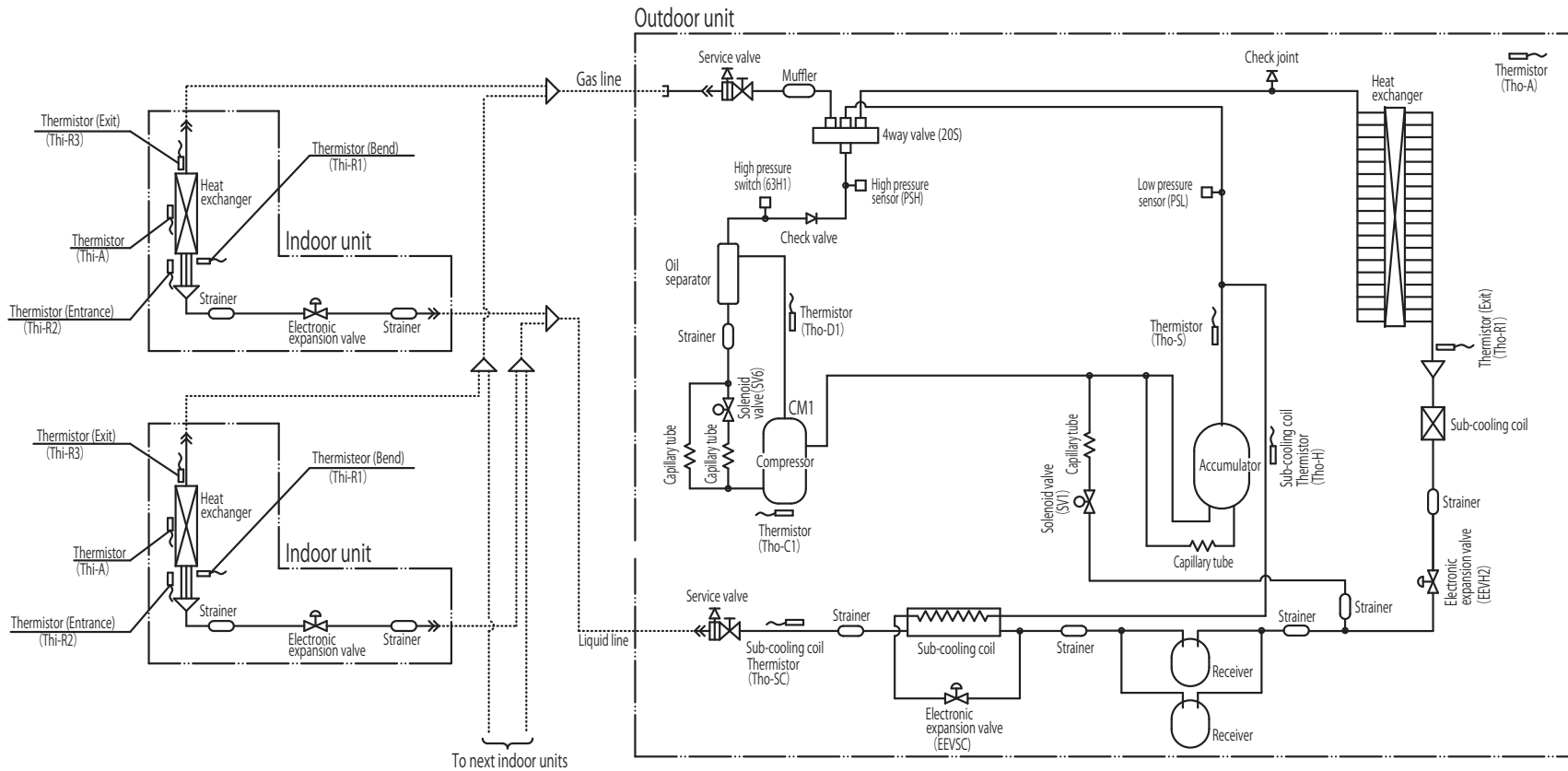

- Notes (1) Preset point of protective device
 63H1 : Open 4.15MPa, Close 3.15MPa
 (For protection)
- (2) Function of thermistor
 PSH : For compressor control
 3.70 ON (MPa)
 PSL : ON 0.18MPa, OFF 0.20MPa
 (For compressor control)
 ON 0.134MPa, OFF 0.18MPa
 (For protection)

- Thi-R1, R2 : Heating operation : Indoor fan control.
 Cooling operation : Frost prevention control.
 Super heat control.
- Thi-R3 : For super heat control of cooling operation.
 Tho-D1 : For control of discharge pipe temperature.
 Tho-C1 : For control of temperature under the dome.
 Tho-S : For control of suction pipe temperature, super heat control.
 Tho-R1: For control of defrosting.
 Tho-A : For control of defrosting.
 Tho-SC : Electronic expansion valve (EEVSC) control of cooling operation.
 Tho-H : For super heat control of sub-cooling coil.

5. SELECTION CHART

(1) Equipment selection flow

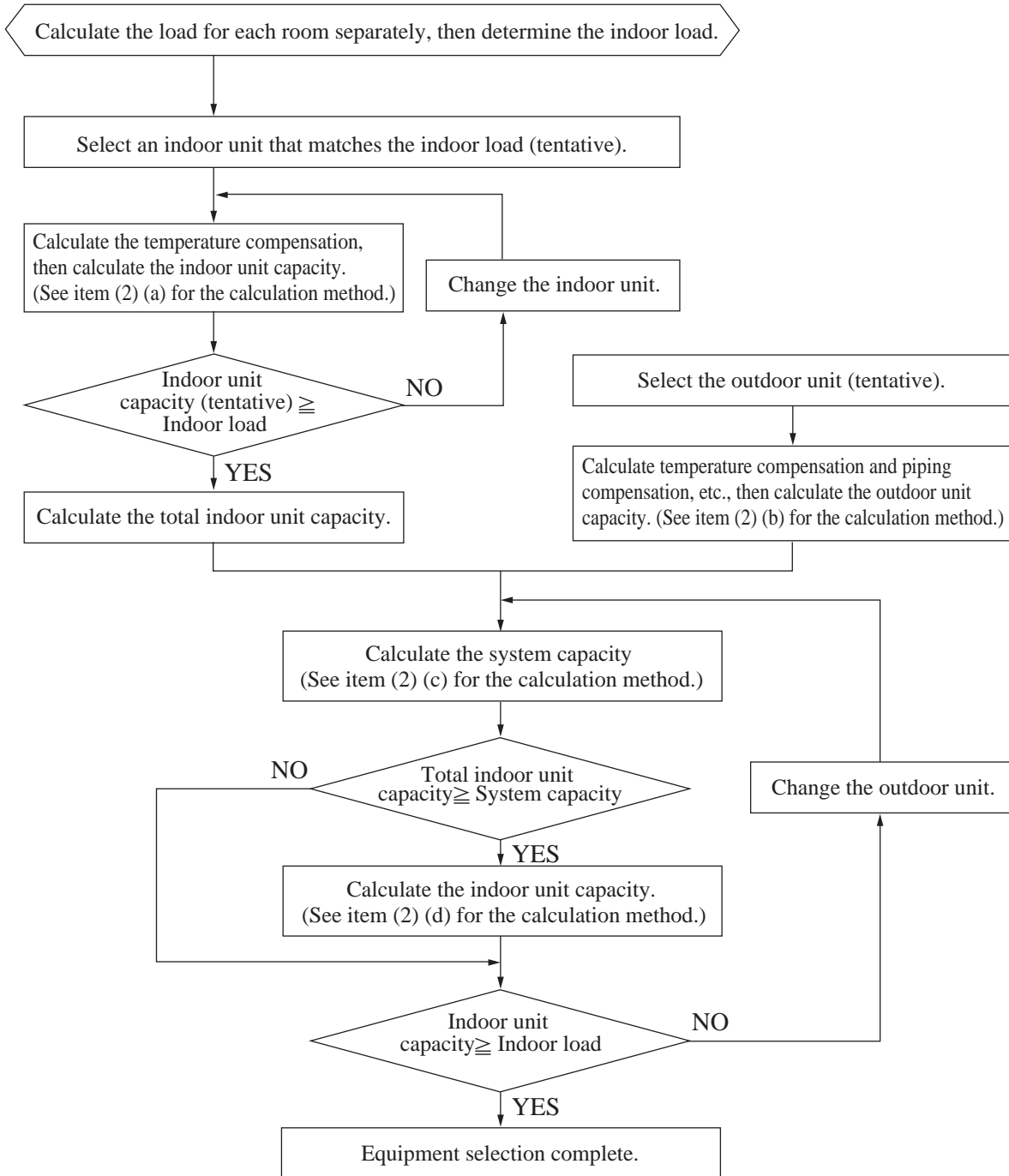

(2) Capacity calculation method**(a) Calculating the indoor unit capacity compensation**

Indoor unit capacity (cooling, heating) = Indoor unit total rated capacity
 × Capacity compensation coefficient according to temperature conditions

See item (3) (a) concerning the capacity compensation coefficient according to temperature conditions.

(b) Calculating the outdoor unit capacity compensation

Outdoor Unit Capacity (Cooling, Heating) = Outdoor unit rated capacity (rated capacity when 100% connected)
 × Capacity compensation coefficient according to temperature conditions
 × Capacity compensation coefficient according to piping length
 × Capacity compensation coefficient according to height difference
 × Correction of heating capacity in relation to the frost on the outdoor unit heat exchanger
 × Capacity compensation coefficient according to indoor unit connection capacity

- ① See item (3) (a) concerning the capacity compensation coefficient according to temperature conditions.
- ② See item (3) (b) concerning the capacity compensation coefficient according to piping length.
- ③ See item (3) (c) concerning the capacity compensation coefficient according to height difference. This compensation should be carried out only in cases where the outdoor unit is lower during cooling and higher during heating.
- ④ See item (3) (d) correction of heating capacity in relation to the frost on the outdoor unit heat exchanger. This compensation should be carried out only when calculating the heating capacity.
- ⑤ See item (3) (e) concerning the capacity compensation coefficient according to indoor unit connected capacity. This compensation should be carried out only in cases where the indoor unit total capacity is 100% or higher.

(c) Calculating system capacity

Compare the capacities determined in items (a) and (b) above and let the smaller value be the system capacity (cooling, heating).

- ① In cases where indoor unit total capacity (cooling, heating) > outdoor unit capacity (cooling, heating)
 System capacity (cooling, heating) = Outdoor unit capacity (cooling, heating)
- ② In cases where indoor unit total capacity (cooling, heating) < outdoor unit capacity (cooling, heating)
 System capacity (cooling, heating) = Indoor unit capacity (cooling, heating)

(d) Calculating indoor unit capacity [item (c) ① only]

Indoor unit capacity (cooling, heating) = System capacity (cooling, heating)
 × [(Indoor unit capacity) / (Indoor unit total capacity)]

Capacity calculation examples**Example 1****Cooling (when the indoor unit connected total capacity is less than 100%)**

- Outdoor unit FDC280KXZPE1..... 1 Unit
- Indoor unit FDT36KXE6F..... 7 Units
- Piping length 60 m (Equivalent length)
- Indoor, outdoor unit height difference 15 m (Outdoor unit is lower)
- Temperature conditions Outdoor temperature: 33°C DB
- Temperature conditions Indoor temperature: 19°C WB

<Indoor unit total cooling capacity>: Item (2) (a) calculation.

- Indoor unit rated cooling capacity: 3.6 kW
- Capacity compensation coefficient according to temperature conditions:
 1.02 (Calculated according to Indoor 19°C WB / Outdoor 33°C DB); (See page 20)
 Indoor unit cooling capacity: 3.6 kW × 1.02 = 3.7 kW
- Indoor unit total cooling capacity calculation;
 indoor unit total cooling capacity: 3.7 kW × 7 units = 25.9 kW

<Outdoor unit maximum cooling capacity> : Item (2) (b) calculation

- Outdoor unit rated cooling capacity: 28.0 kW
- Capacity compensation coefficient according to temperature conditions:
 1.02 (Calculated according to Indoor 19°C WB / Outdoor 33°C DB); (See page 20)
 Outdoor unit cooling capacity: 28.0 kW × 1.02 = 28.6 kW
- Capacity compensation coefficient according to piping length: 0.94 (calculated according to 60 m length); (See page 22)
 28.6 kW × 0.94 = 26.9 kW

- Capacity compensation coefficient according to height difference: 0.97 (calculated according to 15 m difference); (See page 23)
 $26.9 \text{ kW} \times 0.97 = \underline{26.1 \text{ kW}}$
- Capacity compensation coefficient according to indoor unit connected total capacity: $1.0 \leftarrow (36 \times 7) / 280 < 100\%$
 No compensation

<System cooling capacity>: Item (2) (c) calculation

Compare the indoor unit total cooling capacity and the outdoor unit maximum cooling capacity. The smaller value is the actual system cooling capacity.

- Indoor unit total cooling capacity: 25.9 kW \Rightarrow System cooling capacity: 25.9 kW
- Outdoor unit maximum cooling capacity: 26.1 kW

<Indoor unit capacity compensation> No compensation (3.7 kW)

Example 2

Cooling (when the indoor unit connected total capacity is 100% or higher)

- Outdoor unit FDC280KXZPE1..... 1 Unit
- Indoor unit FDT45KXE6F..... 7 Units
- Piping length 60 m (Equivalent length)
- Indoor, outdoor unit height difference 15 m (Outdoor unit is higher)
- Temperature conditions Outdoor temperature: 35°C DB
- Temperature conditions Indoor temperature: 18°C WB

<Indoor unit total cooling capacity>: Item (2) (a) calculation.

- Indoor unit rated cooling capacity: 4.5 kW
- Capacity compensation coefficient according to temperature conditions:
 0.95 (Calculated according to Indoor 18°C WB / Outdoor 35°C DB); (See page 20)
 Indoor unit cooling capacity: $4.5 \text{ kW} \times 0.95 = 4.3 \text{ kW}$
- Indoor unit total cooling capacity calculation;
 indoor unit total cooling capacity: $4.3 \text{ kW} \times 7 \text{ units} = \underline{30.1 \text{ kW}}$

<Outdoor unit maximum cooling capacity> : Item (2) (b) calculation

- Outdoor unit rated cooling capacity: 28.0 kW
- Capacity compensation coefficient according to temperature conditions:
 0.95 (Calculated according to Indoor 18°C WB / Outdoor 35°C DB); (See page 20)
 Outdoor unit cooling capacity: $28.0 \text{ kW} \times 0.95 = 26.6 \text{ kW}$
- Capacity compensation coefficient according to piping length: 0.94 (calculated according to 60 m length); (See page 22)
 $26.6 \text{ kW} \times 0.94 = 25.0 \text{ kW}$
- Capacity compensation coefficient according to height difference: 1.0 (the outdoor unit is higher during cooling)
 No compensation
- Capacity compensation coefficient according to indoor unit connected total capacity: $1.03 \leftarrow (45 \times 7) / 280 = 113\%$ (See page 23)
 $25.0 \text{ kW} \times 1.03 = \underline{25.8 \text{ kW}}$

<System cooling capacity>: Item (2) (c) calculation

Compare the indoor unit total cooling capacity and the outdoor unit maximum cooling capacity. The smaller value is the actual system cooling capacity.

- Indoor unit total cooling capacity : 30.1 kW \Rightarrow System cooling capacity: 25.8 kW
- Outdoor unit maximum cooling capacity : 25.8 kW

<Indoor unit cooling capacity compensation>: Item (2) (d) calculation.

$$\frac{25.8 \text{ kW} \times 4.3 \text{ kW}}{30.1 \text{ kW}} = \underline{3.7 \text{ kW}}$$

Example 3

Heating (when the indoor unit connected total capacity is 100% or higher)

- Outdoor unit FDC280KXZPE1..... 1 Unit
- Indoor unit FDT45KXE6F..... 7 Units
- Piping length 60 m (Equivalent length)
- Indoor, outdoor unit height difference 20 m (Outdoor unit is higher)
- Temperature conditions Outdoor temperature: 6°C DB
- Temperature conditions Indoor temperature: 19°C DB

<Indoor unit total heating capacity>: Item (2) (a) calculation.

- Indoor unit rated heating capacity: 5.0 kW
- Capacity compensation coefficient according to temperature conditions:
 1.04 (Calculated according to Outdoor 6°C WB / Indoor 19°C DB); (See page 21)
 Indoor unit heating capacity: $5.0 \text{ kW} \times 1.04 = 5.2 \text{ kW}$
- Indoor unit total heating capacity calculation;
 indoor unit total heating capacity: $5.2 \text{ kW} \times 7 \text{ units} = \underline{36.4 \text{ kW}}$

<Outdoor unit maximum heating capacity> : Item (2) (b) calculation

- Outdoor unit rated heating capacity: 28.0 kW
- Capacity compensation coefficient according to temperature conditions:
1.04 (Calculated according to Outdoor 6°C WB / Indoor 19°C DB); (See page 21)
Outdoor unit heating capacity: 28.0 kW × 1.04 = 29.1 kW
- Capacity compensation coefficient according to piping length: 0.982 (calculated according to 60 m length); (See page 22)
29.1 kW × 0.982 = 28.6 kW
- Capacity compensation coefficient according to height difference: 0.96 (calculated according to 20 m difference); (See page 23)
28.6 kW × 0.96 = 27.5 kW
- Correction of heating capacity in relation to the frost on the outdoor unit heat exchanger:
1.0 (calculated according to 6°C WB); (See page 23)
27.5 kW × 1.0 = 27.5 kW.
- Capacity compensation coefficient according to indoor unit connected total capacity: 1.0 ← (45 × 7) / 280 = 113% (See page 23)
27.5 kW × 1.0 = 27.5 kW.

<System heating capacity> : Item (2) (c) calculation

Compare the indoor unit total heating capacity and the outdoor unit maximum heating capacity. The smaller value is the actual system heating capacity.

- Indoor unit total heating capacity : 36.4 kW ⇒ System heating capacity: 27.5 kW
- Outdoor unit maximum heating capacity : 27.5 kW

<Indoor unit heating capacity compensation> : Item (2) (d) calculation

$$\frac{27.5 \text{ kW} \times 5.2 \text{ kW}}{36.4 \text{ kW}} = 3.9 \text{ kW}$$

(3) Capacity compensation coefficient

(a) Capacity compensation coefficient and power consumption compensation coefficient according to indoor and outdoor temperature conditions.

1) Capacity compensation coefficient

◆ Cooling

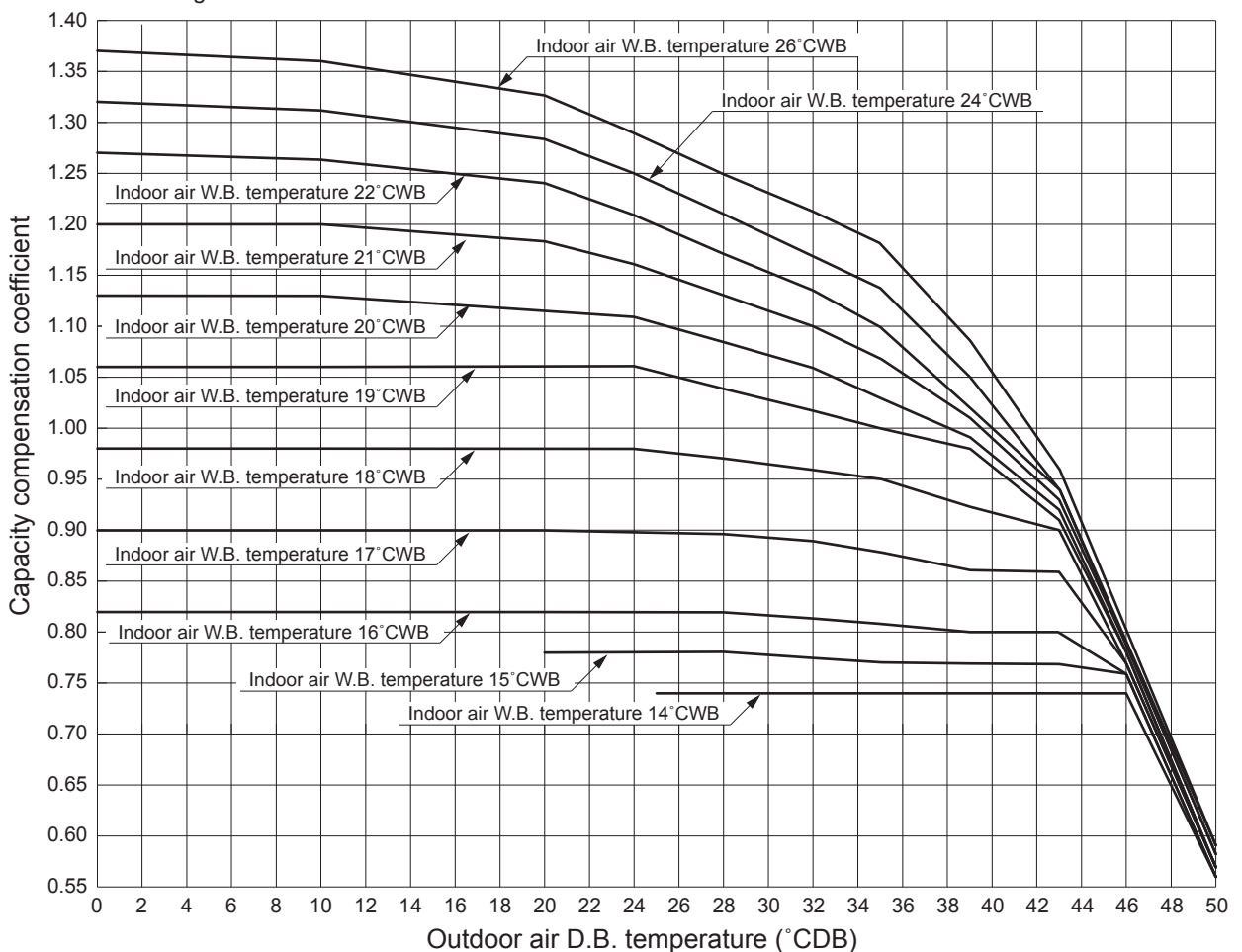

Note (1) The above-mentioned table shows a typical condition among conditions to occur via controlling an air-conditioning equipment.
 (2) When performing the cooling operation with the outdoor air temperature being -5°C or under, a windbreak fence must be installed.

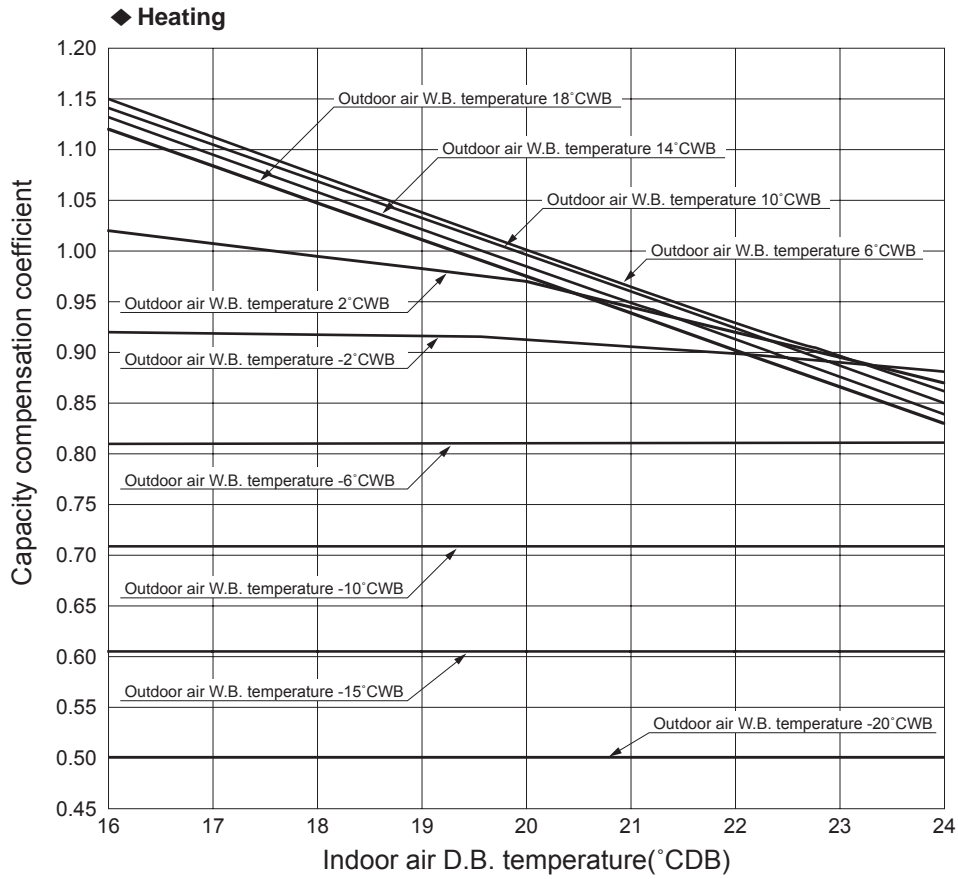

Note (1) The above-mentioned table shows a typical condition among conditions to occur via controlling an air-conditioning equipment.

2) Power consumption correction factor

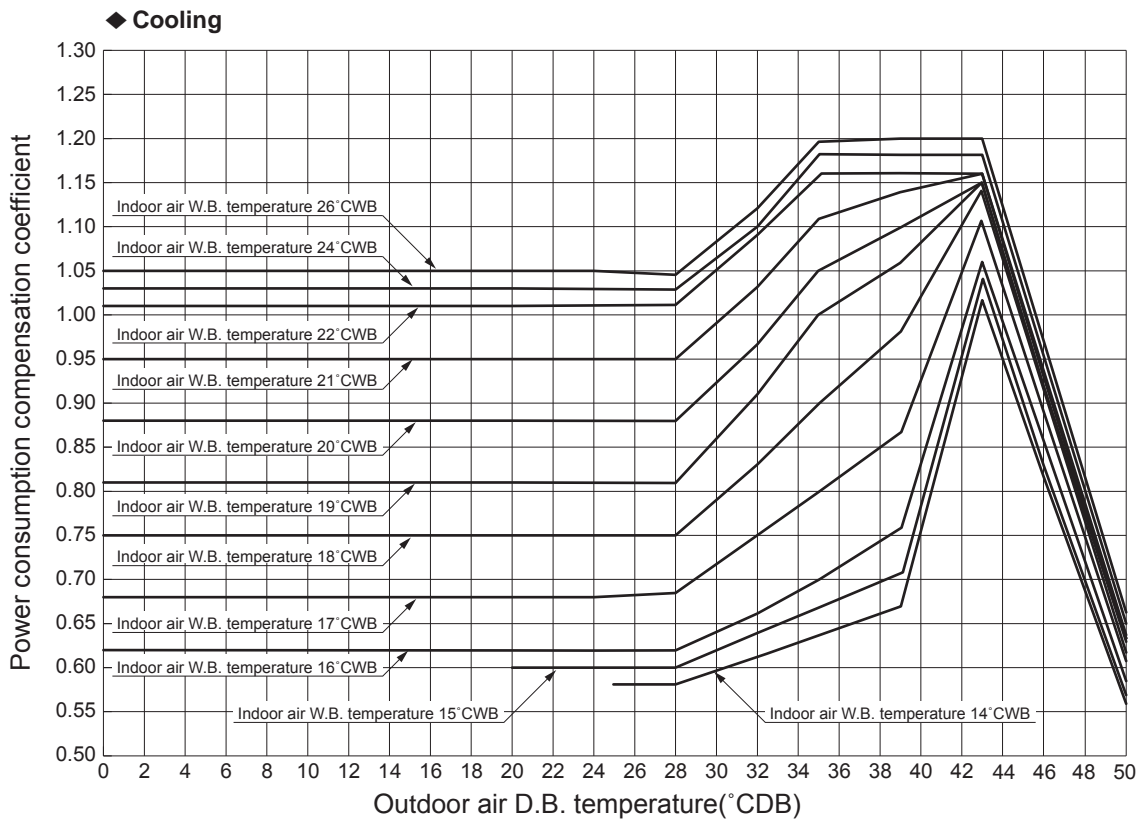

Note (1) The above-mentioned table shows a typical condition among conditions to occur via controlling an air-conditioning equipment.

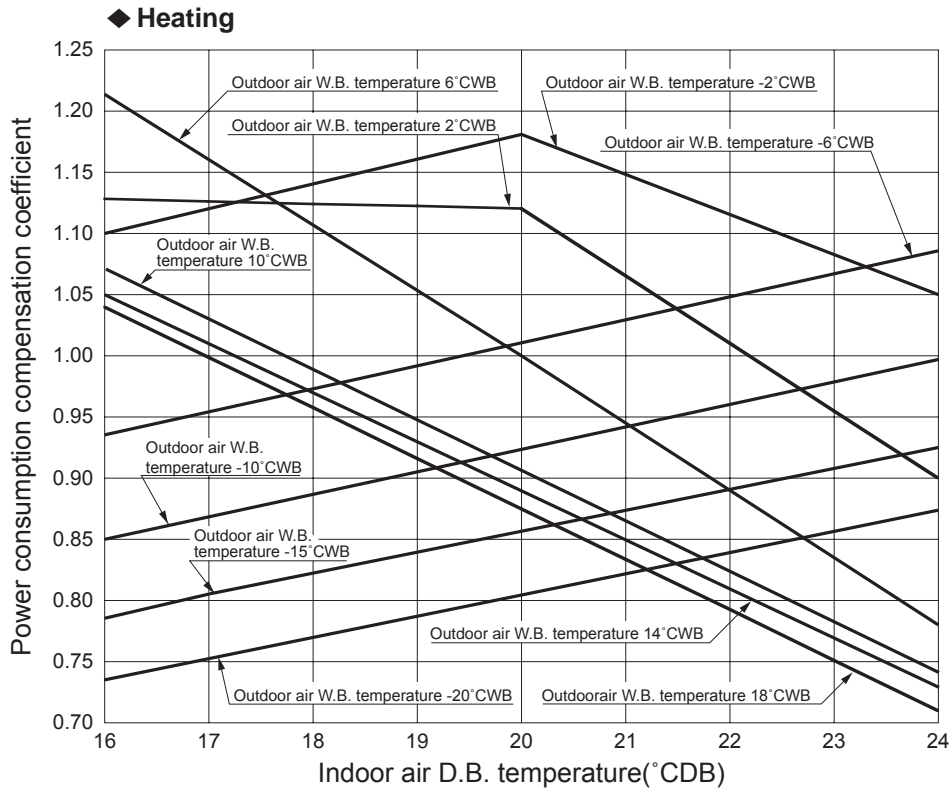

Note (1) The above-mentioned table shows a typical condition among conditions to occur via controlling an air-conditioning equipment.

(b) Correction of cooling and heating capacity in relation to one way length of refrigerant piping.

(Note) This table is for reference only. If the refrigerant piping one way equivalent after the first branch is extended longer than 40m, it could drop further by about 10% in the worst case.

1) Cooling

Model FDC224KXZPE1

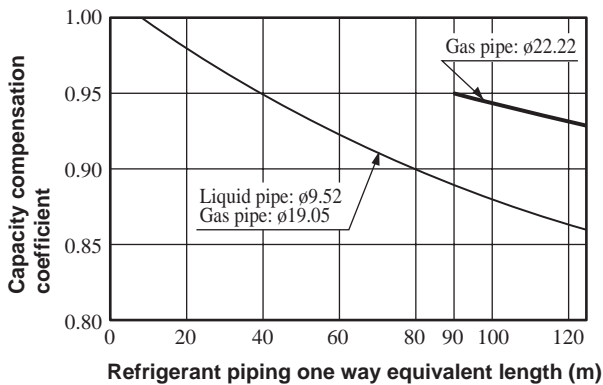

Model FDC280KXZPE1

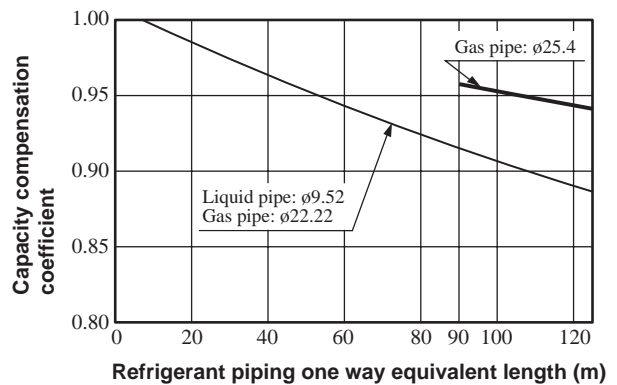

2) Heating

All models

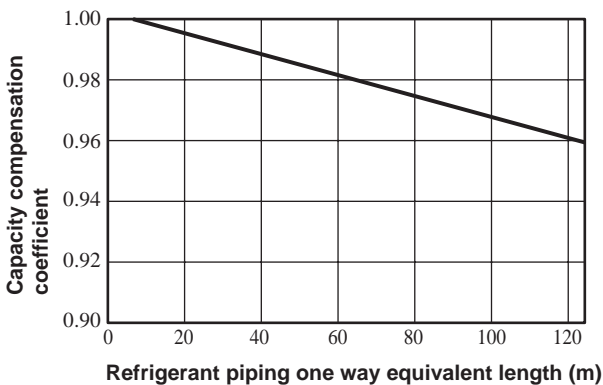

Note (1) Equivalent piping length can be obtained by calculating as follows.

$$\text{Equivalent piping length} = \text{Real gas piping length} + \text{Number of bends in gas piping} \times \text{Equivalent piping length of bends.}$$

Equivalent length of each joint

Unit : m/one pair

Gas piping size	φ19.05	φ22.22	φ25.4	φ28.58
Joint (90° elbow)	0.30	0.35	0.40	0.45

- (c) When the outdoor unit is located at a lower height than the indoor unit in cooling operation and when the outdoor unit is located at a higher height than the indoor unit in heating operation, the following values should be subtracted from the values in the above table.

Height difference between the indoor unit and outdoor unit in the vertical height difference	5 m	10 m	15 m	20 m	25 m	30 m
Adjustment coefficient	0.99	0.98	0.97	0.96	0.95	0.94

- (d) Correction of heating capacity in relation to the frost on the outdoor unit heat exchanger

Air inlet temperature of outdoor unit in °C WB	-20	-15	-13	-11	-9	-7	-5	-3	-1	1	3	6 or more
Adjustment coefficient	0.96	0.96	0.96	0.95	0.94	0.93	0.91	0.88	0.85	0.85	0.88	1

The correction factors will change drastically according to weather conditions. So necessary adjustment should be made empirically according to the weather data of the particular area.

- (e) The capacity compensation coefficient and power consumption compensation coefficient vary according to the total capacity of concurrently operating indoor units, as shown below.

(Note) This table shows typical values.

Model FDC224, 280KXZPE1

◆ **Capability compensation coefficient**

Cooling

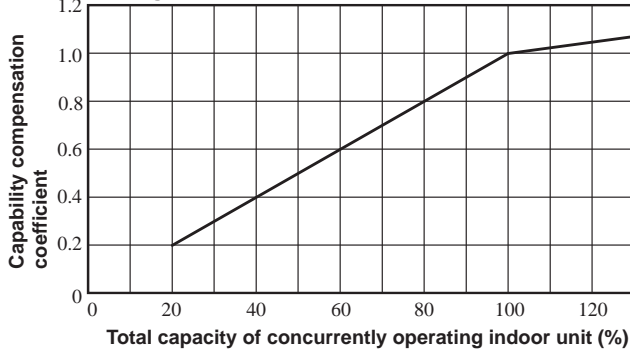

Heating

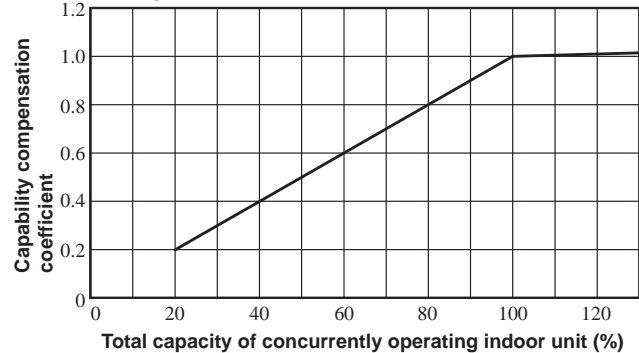

◆ **Power consumption compensation coefficient**

Cooling

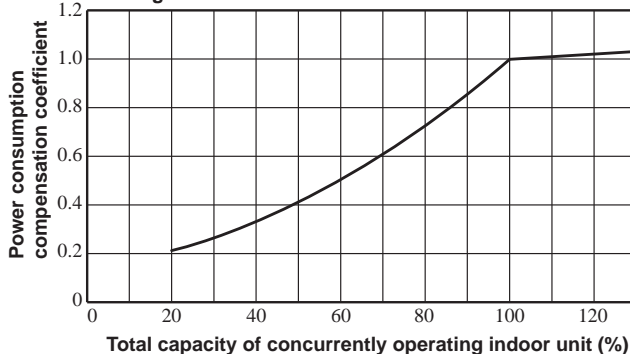

Heating

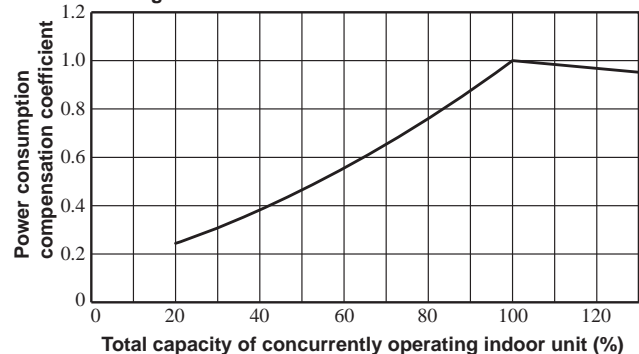

6. WARNINGS ON REFRIGERANT LEAKAGE

Check of concentration limit

The room in which the air conditioner is to be installed requires a design that in the event of refrigerant gas leaking out, its concentration will not exceed a set limit.

The refrigerant R410A which is used in the air conditioner is safe, without the toxicity or combustibility of ammonia, and is not restricted by laws to be imposed which protect the ozone layer. However, since it contains more than air, it poses the risk of suffocation if its concentration should rise excessively.

Suffocation from leakage of R410A is almost nonexistent. With the recent increase in the number of high concentration buildings, however, the installation of multi air conditioner systems is on the increase because of the need for effective use of floor space, individual control, energy conservation by curtailing heat and carrying power etc.

Most importantly, the multi air conditioner system is able to replenish a large amount of refrigerant compared with conventional individual air conditioners. If a single unit of the multi conditioner system is to be installed in a small room, select a suitable model and installation procedure so that if the refrigerant accidentally leaks out, its concentration does not reach the limit (and in the event of an emergency, measures can be made before injury can occur).

In a room where the concentration may exceed the limit, create an opening with adjacent rooms, or install mechanical ventilation combined with a gas leak detection device.

The concentration is as given below.

$$\frac{\text{Total amount of refrigerant (kg)}}{\text{Min. volume of the indoor unit installed room (m}^3\text{)}} \leq \text{Concentration limit (kg/m}^3\text{)}$$

The concentration limit of R410A which is used in multi air conditioners is 0.42kg/m³. (ISO5149)

Note(1) If there are 2 or more refrigerating systems in a single refrigerating device, the amounts of refrigerant should be as charged in each independent device.

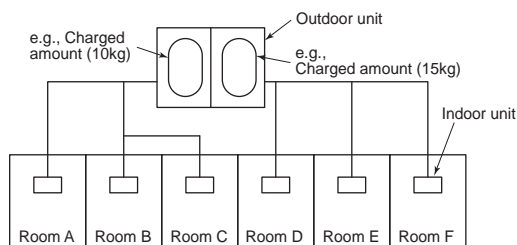

For the amount of charge in this example:
 The possible amount of leaked refrigerant gas in rooms A, B and C is 10kg.
 The possible amount of leaked refrigerant gas in rooms D, E and F is 15kg.

Important

Note(2) The standards for minimum room volume are as follows.

- ① No partition (shaded portion)

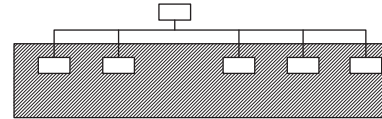

- ② When there is an effective opening with the adjacent room for ventilation of leaking refrigerant gas (opening without a door, or an opening 0.15% or larger than the respective floor spaces at the top or bottom of the door).

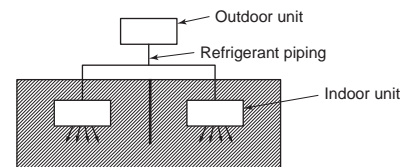

- ③ If an indoor unit is installed in each partitioned room and the refrigerant tubing is interconnected, the smallest of course becomes the object.

But when a mechanical ventilation is installed interlocked with a gas leakage detector in the smallest room where the density limit is exceeded, the volume of the next smallest room becomes the object.

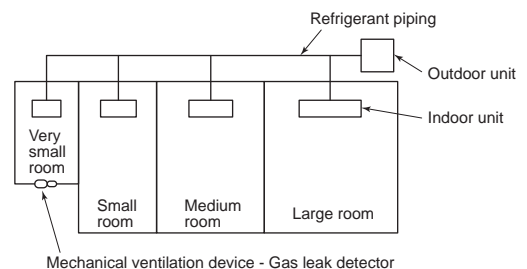

Note(3) The minimum indoor floor area compared with the amount of refrigerant is roughly as follows: (When the ceiling is 2.7m high)

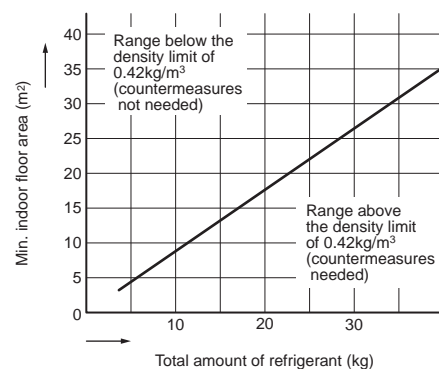

VRF INVERTER MULTI-SYSTEM AIR-CONDITIONERS



Air-Conditioning & Refrigeration Division
16-5, Konan 2-chome, Minato-ku, Tokyo, 108-8215 Japan
<http://www.mhi.co.jp>

Because of our policy of continuous improvement, we reserve the right to make changes in all specifications without notice.

© Copyright MITSUBISHI HEAVY INDUSTRIES, LTD.