

# Air conditioner

---

## Installation manual

ADN\*\*\*BDE\*\* / AM\*\*\*FNBD\*\* / AM\*\*\*FNBF\*\* / AM\*\*\*TNBF\*\*

---

- Thank you for purchasing this Samsung Product.
- Before operating this unit, please read this manual carefully and retain it for future reference.



**SAMSUNG**

# Contents

Safety precautions .....	3
Preparing the installation .....	7
Base construction and installation of the DVM Hydro unit / Hydro unit HT .....	10
Refrigerant pipe installation .....	14
Performing leak test and insulation .....	20
Installing the drain pipe .....	21
Water pipe installation .....	22
Connecting power and communication cable .....	27
Connecting external contact .....	40
Setting an indoor unit address and installation option .....	55
Product maintenance .....	63
Failure diagnosis .....	64
Error code .....	65
Using the PCB Switch .....	67
Completing the installation .....	72
Explaining functions to the user .....	72
Appendix .....	73



## ***Correct Disposal of This Product (Waste Electrical & Electronic Equipment)***

### ***(Applicable in countries with separate collection systems)***

This marking on the product, accessories or literature indicates that the product and its electronic accessories (e.g. charger, headset, USB cable) should not be disposed of with other household waste at the end of their working life. To prevent possible harm to the environment or human health from uncontrolled waste disposal, please separate these items from other types of waste and recycle them responsibly to promote the sustainable reuse of material resources.

Household users should contact either the retailer where they purchased this product, or their local government office, for details of where and how they can take these items for environmentally safe recycling.

Business users should contact their supplier and check the terms and conditions of the purchase contract. This product and its electronic accessories should not be mixed with other commercial wastes for disposal.

For information on Samsung's environmental commitments and product-specific regulatory obligations, e.g. REACH, visit: [www.samsung.com/uk/aboutsamsung/sustainability/environment/our-commitment/data/](http://www.samsung.com/uk/aboutsamsung/sustainability/environment/our-commitment/data/)

# Safety precautions

Before installing an DVM Hydro unit / Hydro unit HT please read this manual thoroughly to ensure that you know how to safely and efficiently install a new appliance.

Store the Operation and Installation in a safe location and remember to hand it over to the new owner if the Product is sold or transferred.



- \* This product uses R-410A and R-134a(Hydro unit HT) are refrigerant.
  - When using R-410A and R-134a(Hydro unit HT), moisture or foreign substances may affect the capacity and reliability of the product. Safety precautions must be taken when installing the refrigerant pipe.
  - The designed maximum pressure of the system is 4.1 MPa. Select appropriate material and thickness according to the regulations.
  - R-410A and R-134a(Hydro unit HT) are a quasi-azeotrope of two refrigerants. Make sure to charge with liquid phase when filling refrigerant. (If you charge vapor refrigerant, it may affect the capacity and reliability of the product as a result of a change in the blend of the refrigerant.)
- \* You must connect the outdoor unit for R-410A refrigerant.
- \* This product uses plate type heat exchanger, and extra concern must be taken regarding on selecting the installation location since it requires water pipe installation.
- \* For product protection, closed type water circuit system must be adopted for water pipe system.

Before the installation, read the 'Severe warning signs' and the 'Caution signs' thoroughly.

Manufacturer is not responsible for accidents due to incorrect installation. (User will be responsible for any service charges that may occur.)

Manufacturer is not responsible for any product problems that may occur due to incorrect water pipe installation.

Maintain the water temperature and the amount of water flow within operational range. Manufacturer is not responsible if the heat exchanger freezes and ruptures due to incorrect installation.

 <b>WARNING</b>	Hazards or unsafe practices that may result in <b>severe personal injury or death.</b>
 <b>CAUTION</b>	Hazards or unsafe practices that may result in <b>minor personal injury or property damage.</b>

# Safety precautions

---

## SEVERE WARNING SIGNS

---

Installation must be requested to a qualified installer.

- ▶ If the user installs a product improperly on their own, it may cause refrigerant leakage and lead to electric shock or fire in worst case scenario.

Install the unit in a place where it is strong enough to hold the product weight.

- ▶ When installed in place where it is not strong enough to withhold the product weight, the unit could fall and cause injury.

Do not put any product or object under the DVM Hydro unit / Hydro unit HT.

- ▶ Water from the DVM Hydro unit / Hydro unit HT may fall and cause fire or loss of property.

Electric work must be done by qualified persons, complying the national wiring regulations and installed according to the instruction stated in the installation manual with leased circuit.

- ▶ Capacity shortage on the leased circuit and improper installation may cause electric shock or fire.

Use the specified wires for wiring. Make sure that the wires are firmly connected and firmly fixed to the terminal connections so that no external is applied to the wires.

- ▶ Improper connection or fixation may cause fire.

Neatly arrange the wires in the electrical parts to make sure that electrical cover is closed securely without any gap.

- ▶ If the cover is not properly closed, heat may generate on the electrical terminal and cause electric shock or fire.

Make sure to use the provided or specified parts with the specified tools for installation.

- ▶ Failing to do so may cause product failure, refrigerant leakage, fire or electric shock.

In any case of refrigerant leakage, make sure to ventilate.

- ▶ If the refrigerant gas comes in contact with fire, harmful gas will be generated.
- ▶ Make sure that the refrigerant gas does not leak after completing the installation. If the refrigerant gas of the indoor unit leaks and comes into contact with the fan heater, space heater or stove, harmful gas will be generated.

Make sure to perform grounding work.

- ▶ Do not connect the ground wire to a gas pipe, water pipe, lightning rod or telephone grounding. Improper grounding could cause electric shock.

Do not install the product in a place where it is or might be exposed to inflammable gas leakage.

- ▶ When the gas leaks and gets accumulated around the product, it may cause fire.

Installation work must be done according to the instruction in this installation manual.

- ▶ Improper installation may cause water leakage, electric shock or fire.

When inserting the power plug, make sure to insert it fully and check that power plug and a consent does not have any dusts, blockage or loosened part.

- ▶ If there are dusts, blockage or loosened part on a power plug or consent, it can cause electric shock or fire. Also, replace the consent if it is loosened.

When installation is in progress, check the following before operating the product.

- ▶ Make sure pipes are properly connected without any leakage.
- ▶ When there is leakage on the connected part, air may get in and cause abnormally high pressure state which may lead to pipe explosion and personal injury.

Do not assemble the power cord on your own, use two cables together to extend the cable length or connect the power to a multi consent connected with other products.

- ▶ Bad connection, isolation and over voltage may cause fire or electric shock.

Cut-off the main power supply before electrical installation of DVM Hydro unit / Hydro unit HT.

- ▶ Potential risk or electric shock.

You may need to install an ELB (earth leakage breaker) depending on the installation location.

- ▶ Not installing an ELB (earth leakage breaker) may cause electric shock.

Supply power to the product for winter even if it is idle, because it operates in protection mode when the temperature goes down to zero.

- ▶ If you cut-off the power, protection mode cannot be operated and may cause damage to the product.
- ▶ DVM Hydro unit / Hydro unit HT is designed to be installed indoor. Make sure to install it in a place where there is no risk of surrounding temperature from dropping below zero.

Wear protective equipment (such as safety gloves, goggles, and headgear) during installation and maintenance works. Installation/repair technicians may be injured if protective equipment is not properly equipped.

This appliance is not intended for use by persons (including children) with reduced physical, sensory or mental capabilities, or lack of experience and knowledge, unless they have been given supervision or instruction concerning use of the appliance by a person responsible for their safety ; Young children should be supervised to ensure that they do not play with the appliance.

**For use in Europe :** This appliance can be used by children aged from 8 years and above and persons with reduced physical, sensory or mental capabilities or lack of experience and knowledge if they have been given supervision or instruction concerning use of the appliance in a safe way and understand the hazards involved. Children shall not play with the appliance. Cleaning and user maintenance shall not be made by children without supervision.

Be sure not to perform power cable modification, midway wiring, and multiple wire connection.

- ▶ It may cause electric shock or fire due to poor connection or insulation and current limit override.
- ▶ When midway wiring is required due to power line damage, refer to "How to connect your extended power cables" in the installation manual.

## CAUTION SIGNS

Read the installation manual thoroughly before installing the product.

Make sure to transport the product with its packages on. In case if you must remove the packaging, use soft materials to carry the product to prevent any damages on the product.

Perform the drainage/piping work securely according to the installation manual.

- ▶ If not, water could drop from the unit and household goods could get wet and damaged.

Wear thick gloves during the installation process.

- ▶ If not, personal injury may occur due to the air conditioner parts.

If the DVM Hydro unit / Hydro unit HT is installed in a small area, beware of oxygen deficiency in the area that may caused by refrigerant leakage.

Do not install or operate DVM Hydro unit / Hydro unit HT in following places:

- ▶ Place where surrounding air contains mineral oil or where oil vapor occurs; or cooking area where vapor or water particles occur by spraying. (When particles of oil sticks to the heat exchanger following incidents may occur; it may cause performance decrease or cause condensation water to scatter. Also, if oil particles sticks to the plastic parts, it may cause damage or deformation of those part which may lead to product malfunction or refrigerant leakage.)
- ▶ Place where corrosive gas, such as sulphurous gas, exists. (When installing the product in these places, contact an installation specialty store since the copper pipe and brazing part will need additional corrosion proof or anti-rust additive to prevent corrosion.
- ▶ Place where product is exposed to flammable gases, carbon fiber, flammable powder/dust or place where volatile flammable gases such as thinner or gasoline is frequently used. (Gases near DVM Hydro unit / Hydro unit HT may ignite.)
- ▶ Place where electromagnetic waves are emitted (Control devices may not work.)
- ▶ Place with high level of basicity within the air such as near ocean; place with high voltage fluctuation such as factory; and within the car or ship.
- ▶ Place where special spray is frequently used.
- ▶ Place where fine powder is used (such as bakery)
- ▶ Do not use the product to store precision instrument, food, plants or animals, cosmetic goods, art works or any other special purpose. (There is risk of property loss.)
- ▶ Place where noise or vibration may occur.

# Safety precautions

## CAUTION SIGNS

After completing the installation, run the trial operation. If no error occurs, explain to the customer how to use and clean the air conditioner according to the user's manual. In addition give the installation manual and the user's manual to the customer.

Before the installation, check if the product is in good shape.

▶ Do not install the product with the damage which occurred during shipment.

All of the materials used to manufacture product and packages are eco-friendly and they are recyclable.

Refrigerant used in this product must be added or disposed in an appropriate way by qualified personnel.

▶ At the end of the life cycle, take it to a proper recycling or disposal center or return it to the dealer so that it can be disposed correctly.

Combination rate

▶ This product should be connected with outdoor unit of the DVM S

▶ The combinations of the installation.

- This product should be combined among 50~130% of outdoor unit's capacity.

- When this product would be combined with heat pump outdoor units for 130~180% combination rate, it need to meet the conditions below.

1) The combination rate for indoor units : Under the 100% of the A2A indoor units + Under the 80% of the DVM Hydro unit/ Hydro unit HT.

2) A2A indoor units should be operated for cooling mode only, and DVM Hydro unit/ Hydro unit HT should be operated for heating mode(including floor heating) only.

3) It is not possible to operate A2A indoor units and DVM Hydro unit/ Hydro unit HT at the same time.

- When combining an outdoor unit with an indoor unit, refer to the tables below for the capacity of DVM Hydro HT.

	Capacity correction
AM160FNBF** AM160TNBF**	14.0kW
AM250FNBF** AM250TNBF**	22.4kW

# Preparing the installation

## Tools required for installation

### General tools



- ① Vacuum pump
- ② Torque wrench
- ③ Pipe cutter
- ④ Reamer
- ⑤ Pipe bender
- ⑥ Spirit level
- ⑦ Screw driver
- ⑧ Spanner
- ⑨ Drill
- ⑩ L wrench
- ⑪ Measuring tape

### Tools for operation

- ① Thermometer
- ② Resistance meter
- ③ Electroscope



## Accessories (supplied)

Before the installation, make sure to check if following accessories are included inside the DVM Hydro unit / Hydro unit HT.

Installation manual	Drain plug	Drain cap
		

## Additional accessory (not included)

Additional accessory needs to be purchased separately and installed to operate DVM Hydro unit / Hydro unit HT.  
[Model name of the wire remote controller: MWR-WW00N (All Model), MWR-WW10N (AM\*\*\*TNBF Model only)]

Wired remote controller	
MWR-WW00N 	MWR-WW10N 

► Recommended specification of the strainer

Model type	Model name	Work pressure	Work temperature	Water pipe connection part	Mesh size	Material (Strainer/Mesh)
HE	ADN160BDE**	1.0 MPa	-5~48 °C	PT 1(25A)	50 Mesh	AISI316/SUS304
	ADN320BDE**					
	AM160FNBD**					
	AM320FNBD**					
	ADN500BDE**					
AM500FNBD**						
HT	AM***FNBF** AM***TNBF**		-20 ~ 43 °C	PT 1(25A)		

# Preparing the installation

## Selecting installation location

- ▶ Choose a place with ventilation duct or opening to cool down the heat generated from the product and maintain the surrounding temperature within Hydro unit : 5 ~ 40 °C, humidity 80 % Hydro unit HT : 5 ~ 35 °C humidity 80 %.
- ▶ Choose a place where structure can bear the weight and vibration of the DVM Hydro unit / Hydro unit HT.
- ▶ Choose a flat place that rainwater does not settle or leak.
- ▶ Choose a well ventilated place with sufficient space for repair and other services.
- ▶ Choose a place where you can easily connect the refrigerant pipes between the DVM Hydro unit / Hydro unit HT and outdoor unit within allowable distance.
- ▶ Do not install this product in a place where it may corrode.
- ▶ Install the power cable and communication cable of the DVM Hydro unit / Hydro unit HT and outdoor unit at least 1 m away from the electric appliance such as TV. (In some cases, there may be problem even if there's more than 1m gap from the electric appliances.)

## Space requirement

- ▶ When installing the product, make sure to secure minimum distance with obstacles as shown below.
- ▶ When you install one product on top of the other one, secure at least 600 mm of space on the water pipe side.

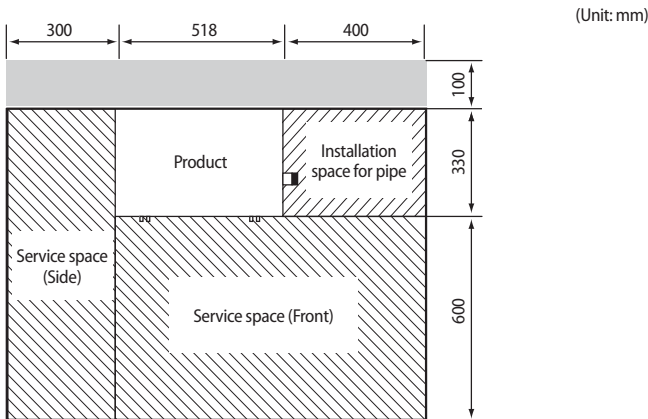



# Hydro unit

(Unit: mm)

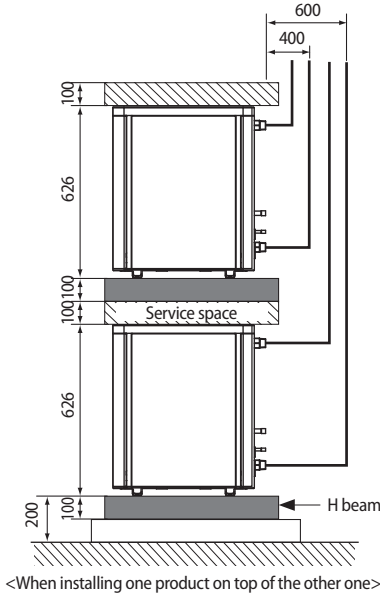

# Hydro unit HT

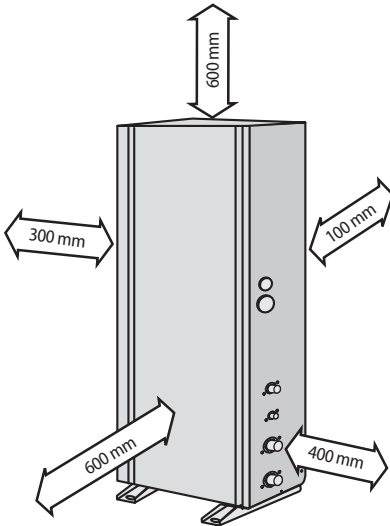

• If the Hydro unit / Hydro unit HT is needed installed closed to the walls unavoidably, prevent the vibration generated from the product to the walls with cushioning materials etc.

# Base construction and installation of the DVM Hydro unit / Hydro unit HT



• If this product is installed in residential area, apply anti-vibration product to prevent the vibration from transferring to the building.

- ▶ Manufacturer is not responsible for the damage occurred by not following the installation standards.
1. Considering the vibration and weight of the DVM Hydro unit / Hydro unit HT, strength of the base ground must be strong enough to prevent noise and the top part of the base ground has to be flat.
  2. Base ground should be 1.5 times larger than the bottom of the Hydro unit.
  3. It is necessary to add wire mesh or steel bar during concrete construction for the base ground to prevent damages or cracks.
  4. Place the DVM Hydro unit / Hydro unit HT on the base construction and completely fix it with the bolt, nut and washer. (The bearing force has to be over 3.5 kN)
  5. Fix the DVM Hydro unit / Hydro unit HT firmly with 4 foundation bolts.
  6. When concrete construction for DVM Hydro unit / Hydro unit HT installation is completed, install an anti-vibration pad( $t=20$  mm or more) or an anti-vibration frame(vibration transmissibility=5 % and below) to prevent vibration of the outdoor unit from transferring to the base ground.
  7. When constructing base ground, DVM Hydro unit / Hydro unit HT must be supported within the range of following dimensions.

## Base ground construction

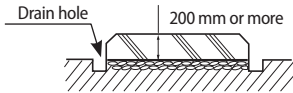

## DVM Hydro unit installation

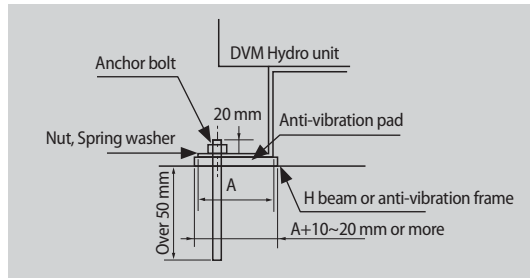
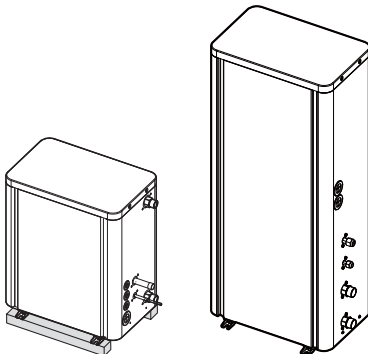
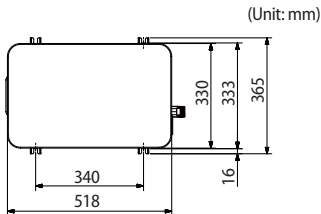

## DVM Hydro unit HT installation

Considering the vibration and weight of the DVM Hydro unit HT, strength of the base ground must be strong enough to prevent noise and the top part of the base ground has to be flat.

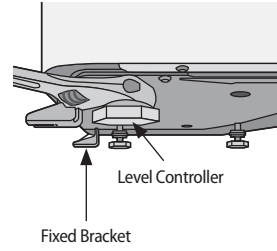

Adjust the level controller to make fixed controller has to be min. 10 mm higher than level controller.

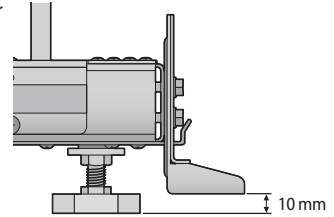

Place the DVM Hydro unit HT on the base construction and completely fix it with the foundation bolt(M10), nut and washer.

The recommended length of foundation bolts are over 20 mm from the base ground.

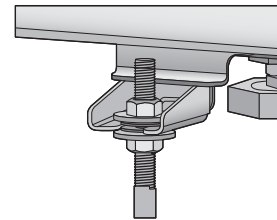

< A method of fixing the bracket >

# Base construction and installation of the DVM Hydro unit / Hydro unit HT

## Anchor specification

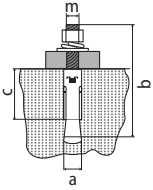

Size	Diameter of drill bit (a)	Anchor length (b)	Sleeve length (c)	Insert depth	Fastening torque
M10	14 mm	75 mm	40 mm	50 mm	30 N·m

## Dimension of the DVM Hydro unit

(Unit: mm)

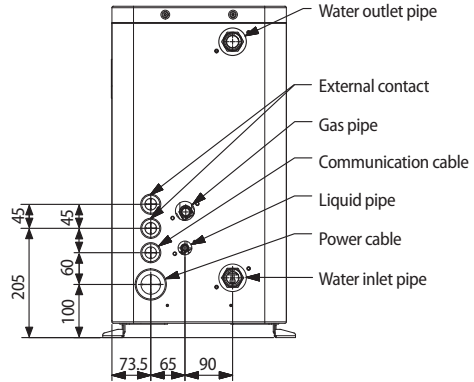
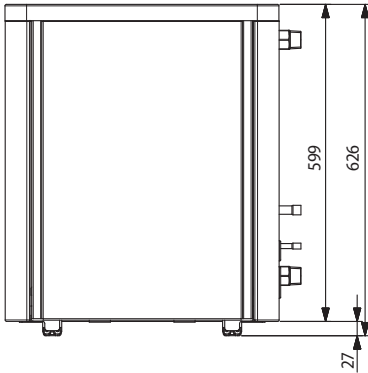
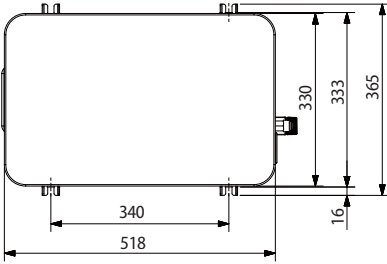

Model of the DVM Hydro unit		ADN160BDE** AM160FNBD**	ADN320BDE** AM320FNBD**	ADN500BDE** AM500FNBD**
Refrigerant side	Liquid side connection part	3/8" (ø9.52)	3/8" (ø9.52)	1/2" (ø12.7)
	Gas side connection part	5/8" (ø15.88)	7/8" (ø22.23)	1-1/8" (ø28.58)
Water side connection part		PT 1 (25A)	PT 1 (25A)	PT 1-1/4 (32A)

## Dimension of the Hydro unit HT

(Unit: mm)

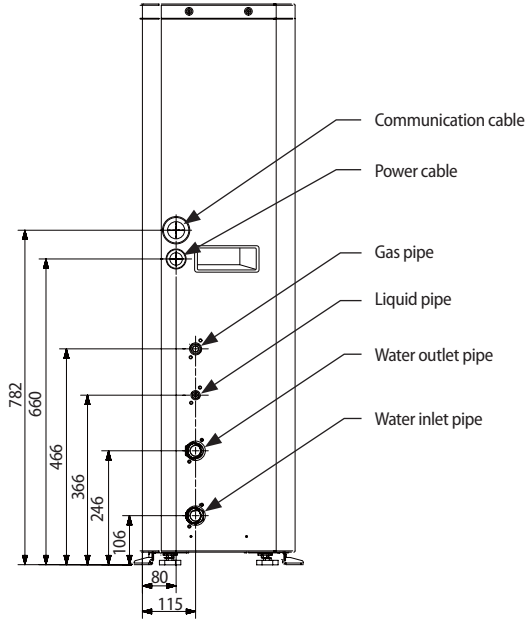
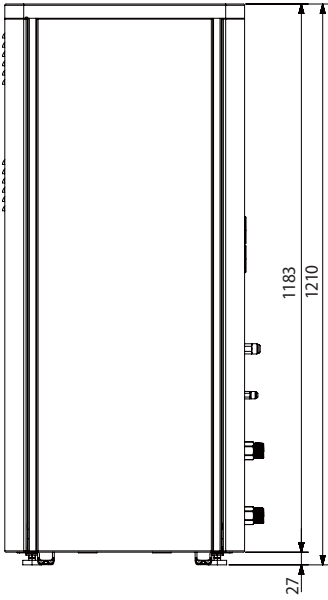
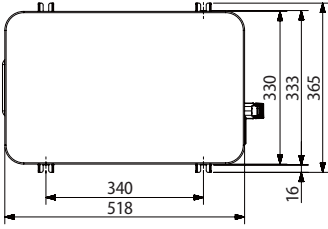

Model of the Hydro unit		AM***FNBF*B AM***TNBF**
Refrigerant side	Liquid side connection part	3/8" (ø9.52)
	Gas side connection part	5/8" (ø15.88)
Water side connection part		PT 1(25A)

# Refrigerant pipe installation

## Refrigerant pipe work

- ▶ Use exclusive tools and accessories for R-410A to respond to pressure of the R-410A and prevent foreign substances from entering into the pipes.
- ▶ The length of refrigerant pipe should be as short as possible and the height difference between the DVM Hydro unit / Hydro unit HT and outdoor unit should be minimized.
- ▶ Piping work must be done within allowable piping length, height difference, and the allowable length after branching.
- ▶ The pressure of the R-410A is high. Use only certified refrigerant pipe and follow the installation method.
- ▶ Use clean refrigerant pipe and there shouldn't be any harmful ion, oxide, dust, iron content or moisture inside pipe.
- ▶ Pipe work must be done aside from the product.
- ▶ After completing the pipe installation, calculate the additional amount of refrigerant according to method of each indoor units and make sure to use R-410A refrigerant when charging. (Color of the R-410A refrigerant container is painted in pink.)

Model name of DVM Hydro unit	ADN160BDE** AM160FNBD** AM***FNBF** AM***TNBF**	ADN320BDE** AM320FNBD**	ADN500BDE** AM500FNBD**
Amount of additional refrigerant	0.6 kg	0.7 kg	1.2 kg

- ▶ Do not use Flux when welding the refrigerant pipes.



- The maximum number of the Hydro Unit HT connectable to one system(module) is 3 units.
- In case the capacity conjunction of the Hydro Unit HT/HE exceeds 50 % among the total indoor unit, please don't put the additional refrigerant.
  - When operate Hydro unit HT to add R-410A refrigerant at the outdoor unit side, Hydro unit HT will not work for cooling refrigerant charging operation if water temperature is under 33°C. Perform heating refrigerant charging operation or perform cooling refrigerant charging operation after warming water up over 33°C.
  - When operate Hydro unit HT to collect R-410A refrigerant at the outdoor unit side, Hydro unit Ht will not work if water temperature is under 33°C. Perform refrigerant collecting operation after warming water up over 33°C.
  - All other indoor units should perform the heating or stop, when R-134a refrigerant collecting operation.

## Important information regulation regarding the refrigerant used

- ▶ DVM Hydro unit HT contains fluorinated greenhouse gases.
- ▶ Do not vent gases into the atmosphere.
- ▶ Refrigerant type : R-134a
- ▶ Quantity: 2.15 kg (3.075 tCO<sub>2</sub>e)
- ▶ Global Warming Potential(GWP) = 1430
- ▶ Hermetically sealed equipment

Please fill in the following with indelible ink on the refrigerant charge label supplied with this product and on this manual.

- ▶ ① the factory refrigerant charge of the product.
  - ▶ ② the additional refrigerant amount charged in the field.
  - ▶ ①+② the total refrigerant charge.
- \* The refrigerant charge label supplied with the product.

Unit	kg	tCO <sub>2</sub> e
①, a		
②, b		
①+②, C		

Refrigerant type	GWP value
R-410A	2088

- GWP=Global Warming Potential
- Calculating tCO<sub>2</sub>e : kg x GWP / 1000



- a Factory refrigerant charge of the product: see unit name plate.
- b Additional refrigerant amount charged in the field. (Refer to the above information for the quantity of refrigerant replenishment.)
- c Total refrigerant charge.
- d Refrigerant cylinder and manifold for charging.



- The filled-out label must be adhered in the proximity of the product charging port. (ex. onto the inside of the stop valve cover.)
- The F-GAS label must be adhered in the proximity of the product.

## Tools used for refrigerant pipe installation

Product using R-410A/R-134a refrigerant requires exclusive tools. Check the conventional tools for compatibility before installation.

Tool	Work	Compatibility with conventional tool	
Pipe cutter	Refrigerant pipe work	Pipe cutting	Compatible
Flaring tool		Pipe flaring	
Refrigerating machine oil		Apply refrigerant oil on flared part	Use exclusive ether oil, ester oil, alkali benzene oil or mixture of these oils
Torque wrench		Connect flare nut with pipe	Compatible
Pipe bender		Pipe bending	
Nitrogen gas	Air tightness test	Inhibition of oxidation	
Welder		Pipe welding	
Manifold gauge	Air tightness test ~ additional refrigerant charging	Vacuuming, charging and checking operation	Need exclusive one to prevent mixture of R-22 refrigerant oil use and also the measurement is not available due to the high pressure.
Refrigerant charging hose			Need exclusive one due to the refrigerant leakage or inflow of impurities.
Vacuum pump	Vacuum drying	Compatible (Use products which contains the check valve to prevent the oil from flowing backward into the outdoor unit.) Use the one that can be vacuumed up to 100.7 kPa (5 Torr).	
Scale for refrigerant charging		Compatible	
Gas leak detector		Gas leak test	Need exclusive one (Ones used for R-134a is compatible)
Flare nut	Must use the flare nut equipped with the product. Refrigerant leakage may occur when the conventional flare nut for R-22 is used.		

# Refrigerant pipe installation

## Selecting refrigerant pipe

- ▶ Install the refrigerant pipe according to main pipe size for each capacities of DVM Hydro unit / Hydro unit HT.

Model name of DVM Hydro unit		ADN160BDE** AM160FNBD** AM***FNBF** AM***TNBF**	ADN320BDE** AM320FNBD**	ADN500BDE** AM500FNBD**
Refrigerant side	Liquid side	3/8" (ø9.52)	3/8" (ø9.52)	1/2" (ø12.7)
	Gas side	5/8" (ø15.88)	7/8" (ø22.23)	1-1/8" (ø28.58)

## Keeping refrigerant pipe

- ▶ To prevent foreign materials or water from entering the pipe, storing method and sealing method (especially during installation) is very important. Apply correct sealing method depending on the environment.
- ▶ Be especially careful when you penetrate the pipe through the hole in a wall or when the end of the pipe is exposed to outdoor during installation.
- ▶ Use the flare nut supplied with the product. If other flare nuts are used, it can cause refrigerant leakage.

Exposure place	Exposure time	Sealing type
Outdoor	Longer than one month	Pipe pinch
	Shorter than one month	Taping
Indoor	-	Taping

## Pinching the refrigerant pipe

- ▶ Compress the end of the refrigerant pipe and weld the compressed part.

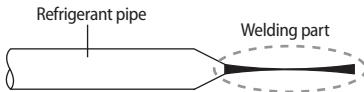

## Taping the refrigerant pipe

- ▶ Seal the end of the refrigerant pipe with a PVC vinyl tape.

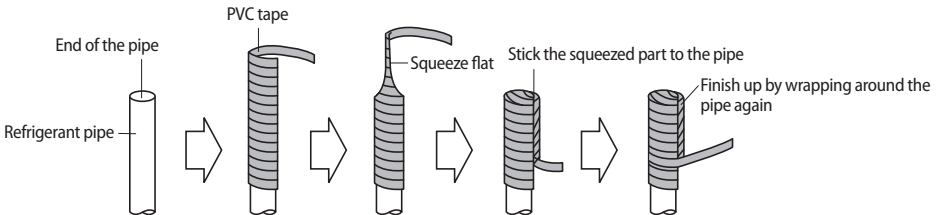



## Refrigerant pipe welding and safety information

### Important information for refrigerant pipe work

- ▶ Make sure there is no moisture inside the pipe.
- ▶ Make sure there are no foreign substances and impurities in the pipe.
- ▶ Make sure there is no leakage.
- ▶ Make sure to follow the instruction when welding or storing the pipe.

### Nitrogen flushing welding (DVM Hydro unit)

- ▶ When welding the refrigerant pipes, flush them with nitrogen gas as shown in the picture.
- ▶ If you do not perform nitrogen flushing when welding the pipes, oxide may form inside the pipe and can cause damage to the important parts such as compressor and valves etc.
- ▶ Adjust the flow rate of the nitrogen flushing with a pressure regulator to maintain 0.05 m<sup>3</sup>/h or less.
- ▶ When welding the pipes on the connection port, cover the valve with wet cloth before welding (to protect the parts within the valve)

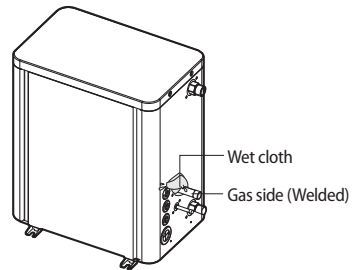
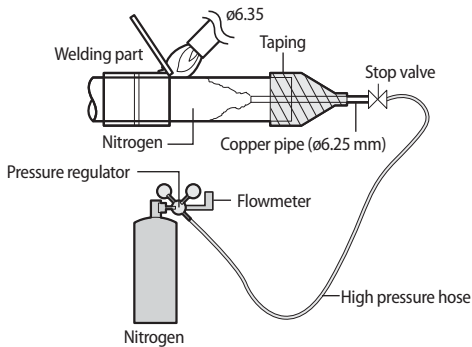

### Direction of the pipe when welding

- ▶ Direction of the pipe should be headed downward or in a sideways when welding.
- ▶ Avoid welding the pipe with pipe direction heading upward.

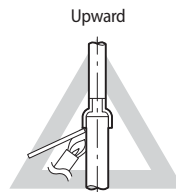
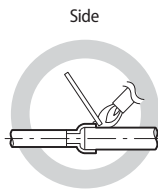
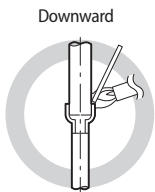

# Refrigerant pipe installation

## Refrigerant pipe work on DVM Hydro unit

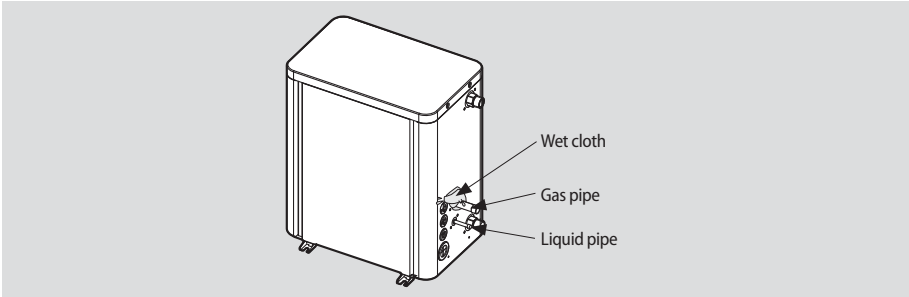

### • Caution for welding the pipe to a DVM Hydro unit

- When welding the pipe to the product, the unit may get damaged by the heat and flame from welding. Use a flame proofing cloth to protect the unit from a brazing fire or flame.
- Wrap the pipe with a wet cloth and weld it as shown in the illustration. Also, water dripping from the wet cloth may interrupt the welding so make sure the water does not drip from the wet cloth.
- Make sure that connected pipes of DVM Hydro unit and the outdoor unit does not interrupt each other or make contact with the product. (Vibration may cause damage to the pipes.)
- When removing the sealed pipe on the bottom side of the service valve, cut it with a pipe cutter first and then start the welding. When the sealed pipe is welded without cutting, you may get injured by the refrigerant within the pipe.

1. Remove the copper cap of the refrigerant pipe and eliminate the sludge or foreign substances on the welded part and then weld the connecting pipe on each port.
  - Since nitrogen gas is sealed within the pipe, you must discharge the nitrogen gas from the liquid pipe. Then remove the copper cap and check for existence of the nitrogen gas.
  - Check the pressure of the nitrogen gas before welding. If the nitrogen gas is not being purged, product is not normal so do not install it.

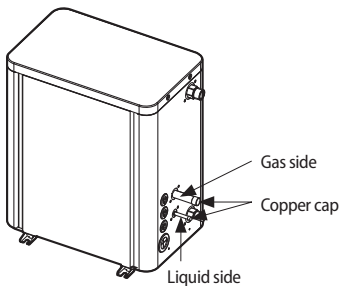

2. Cover the refrigerant pipe well with an insulator.
  - It prevents the water, on the outer surface of the pipe, from dripping and increase the efficiency of the DVM Hydro unit.
3. Cut off the leftover insulator.
4. Check for cracks on the bent part of the pipes.
5. When the DVM Hydro unit is installed in a hot and humid place, water may form on the outer surface of the insulator so it would be necessary to double the insulation thickness (10mm or more).

## Refrigerant pipe work on DVM Hydro unit HT

DVM Hydro unit HT has refrigerant pipes of two different types.

- ▶ Liquid side pipe
- ▶ Gas side pipe
- ▶ Make sure there are no foreign substances and impurities in the pipe.



- There is no nitrogen gas inside of connected pipes of Hydro unit HT and the outdoor unit.
- DVM Hydro unit HT is using the new refrigerant, R-134a. The connected pipes of Hydro unit HT and the outdoor unit are using R-410A
- If impurities (moisture, micro-substances) are introduced into the refrigerant pipes, the product performance and reliability may be seriously affected.
- The design pressure is 4.1 MPa, and make sure to consider selecting the refrigerant pipes which meet the standard(material, thickness)
- Make sure to use liquid refrigerant when charging the refrigerant, because the used refrigerant is a mixture refrigerant.
- \* DVM Hydro unit HT is using heat exchanger of plate type, and make sure to consider installation location to connecting water pipes.

1. Remove the safety cap of the refrigerant pipe and fasten the nuts after connecting refrigerant pipes to each port of the Hydro unit HT.
  - ▶ Make sure to fasten the nut using hand of person first, after that use tools like torque wrench and spanner.

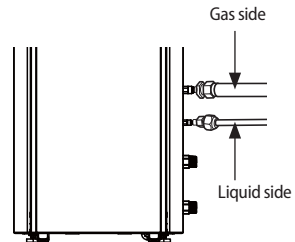

2. Wrap the refrigerant pipes with insulator.
3. Cut the rest of insulator.
4. Make sure to check any defects on the bent parts of the pipes.
5. The standard temperature and humidity condition is 30 °C with humidity below 85 %. If the condition is in high humidity, use one grade thicker. (Over 10 mm)

# Performing leak test and insulation

Before completing the installation (insulating hose and pipes), you must check for gas leakage and when there is no leakage, you may insulate the pipes and hoses.

## Leak test

Use a gas detector to check the connection part of the pipes for gas leakage.

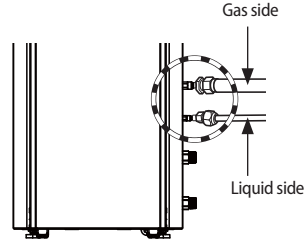
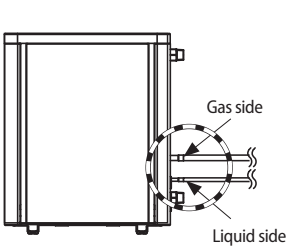

## Insulation

### Selecting the insulator of refrigerant pipe

- ▶ Insulate the gas pipe and liquid pipe by referring to the thickness of insulator for each pipe size.
- ▶ The standard temperature and humidity condition is 30 °C with humidity below 85 %. If the condition is in high humidity, use one grade thicker.

Pipe	Pipe size (mm)	Thickness of the insulator [Cooling, Heating (mm)]		Remarks
		Standard [30 °C, 85 %]	High humidity [30 °C, 85 % or more]	
		EPDM, NBR		
Liquid pipe	Ø6.35~Ø9.52	9	9	Heat resisting temperature should be over 120 °C
	Ø12.70~Ø19.05	13	13	
Gas pipe	Ø6.35	13	19	
	Ø9.52 ~ Ø28.58	19	25	

- To avoid condensation problems, wrap each pipes with heat-resisting polyethylene foam.
  - Make sure that the opening part of the insulation to face up.

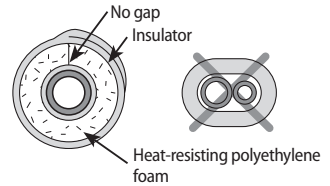

- Wrap the refrigerant pipes and drain pipes with insulator.

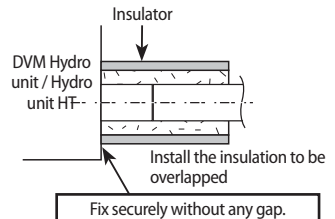

# Installing the drain pipe

## Installing the drain pipe

- ▶ Use a spirit level to make sure that product is horizontally leveled.
- ▶ Choose one of the 2 drain holes on the bottom of the product and insert the provided drain plug, then connect the drain pipe.
- ▶ From the 2 drain holes, block the unused hole with the provided rubber plug.
- ▶ Install the drain pipe at the rear side of the unit to get a sufficient space for repairs and service on the front side.
- ▶ Do not install a trap on the pipe and install the drain pipe horizontally with a slope of 1/50 or more to prevent water from flowing backwards.
- ▶ For smooth drainage, install an air vent that is open to air.
- ▶ Insulate the drain pipe and drain plug with insulation over 10 mm.
- ▶ Install self-regulating heat cable on the drain pipe to prevent it from being frozen.
- ▶ Install the safety equipment for a heating appliance.

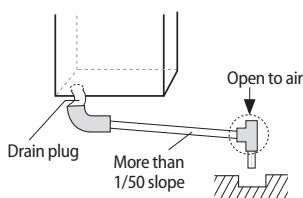

## When concentrated drainage is installed

- ▶ Install a concentrated drain pipe with an air vent that is open to air.

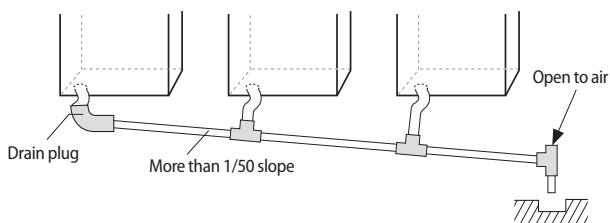

## Checking the water leakage

Prepare about 2 liters of water and pour water into the drain pan of the DVM Hydro unit / Hydro unit HT as shown in the illustration.

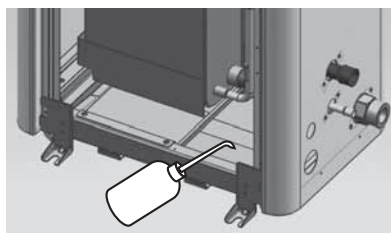

<DVM hydro unit>

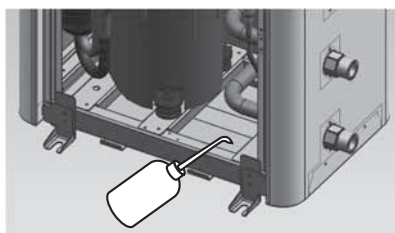

<DVM hydro unit HT>

# Water pipe installation

1. Use closed type water pipe and closed type expansion tank when constructing water piping system.
2. Water pipe installation system
  - 1) Install the water pipe as shown in the below illustration. All the parts, other than DVM Hydro unit / Hydro unit HT, must follow on site installation specification.

<Water pipe connection part>

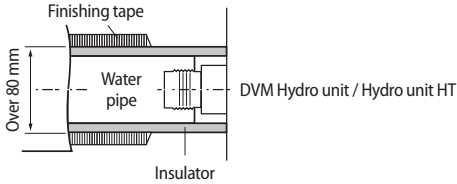

► Installing hot water supply

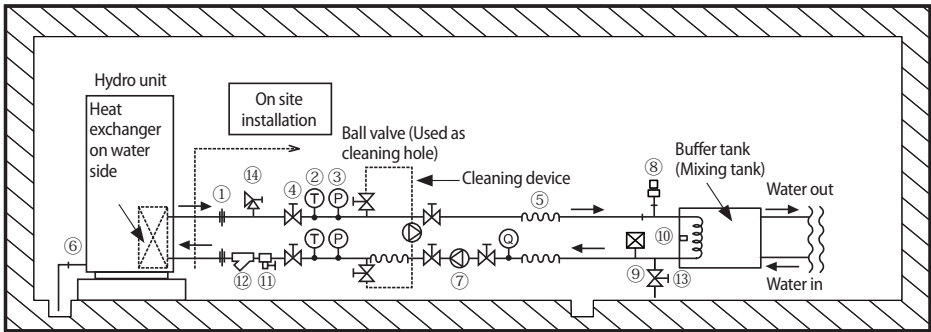

①	Water pipe joint (union, flange)	⑤	Flexible joint	⑨	Expansion tank
②	Thermometer	⑥	Drain (within the product)	⑩	Temperature sensor for hot water tank
③	Manometer	⑦	Pump	⑪	Drain valve
④	Ball valve	⑧	Air vent	⑫	Strainer
⑬	Water Valve	⑭	Pressure relief valve (Pressure safety valve)		

► Installing under floor heating

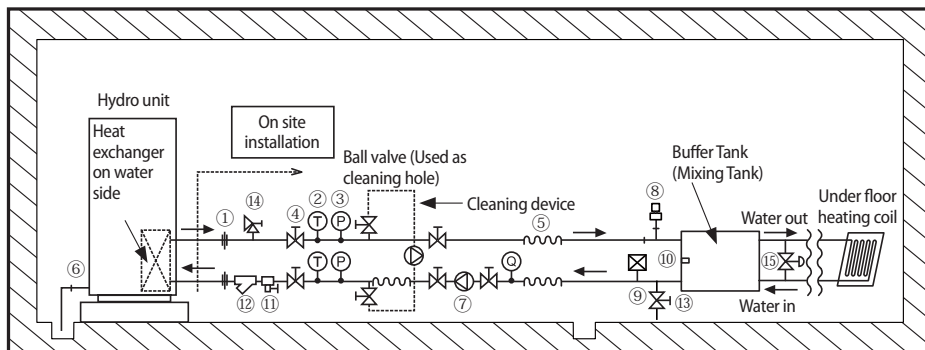

①	Water pipe joint (union, flange)	⑤	Flexible joint	⑨	Expansion tank
②	Thermometer	⑥	Drain (within the product)	⑩	Temperature sensor for thermal storage tank
③	Manometer	⑦	Pump	⑪	Drain valve
④	Ball valve	⑧	Air vent	⑫	Strainer
⑬	Water Valve	⑭	Pressure relief valve (Pressure safety valve)	⑮	Differential Pressure bypass Valve

When more than two water pipes are used for heating (e.g. Floor + Fan Coil Unit), Buffer Tank (Mixing Tank) or bypass valve should be used to maintain the water flow rate.

► On site installation specification

Model name	Strainer	Flow meter	Thermometer	Manometer	Air vent	Pump	Ball valve	Drain valve
AM160FNBF** AM160TNBF**	#50 PT 1	0~50 l/min	0~100 °C	0~1 MPa	0.6 m³/h (Condition: 0.15 MPa)	23 l/min	PT 1	15 A
AM250FNBF** AM250TNBF**		0~100 l/min				36 l/min		
ADN160BDE** AM160FNBD**		0~50 l/min				48 l/min		
ADN320BDE** AM320FNBD**		0~100 l/min				92 l/min (Refer to pressure drop graph)		
ADN500BDE** AM500FNBD**	#50 PT 1-1/4	0~150 l/min	0~100 °C	0~1 MPa	0.6 m³/h (Condition: 0.15 MPa)	150 l/min (Refer to pressure drop graph)	PT 1-1/4	15 A

# Water pipe installation

- 2) Water pipe socket must be connected with a less tightening torque value stated in the below table. If you apply more torque, it may cause damage to the product.

Diameter of water pipe (Outer diameter, mm)	Tightening torque (N·m)
ø10~20	25
ø21~30	50
ø31~50	100
ø51~80	220
ø81~115	600

\* 1 N·m = 10 kgf·cm

- 3) Use certified parts for water pipe system and the water pressure of the water pipe system connected to outdoor unit must remain under 1.0 MPa. Use copper or stainless pipe water pipe.
- 4) Water pipes must be equipped with valves and other instrumentations as shown in the diagram. Strainer must be installed within 1~2 m from the entrance pipe of the DVM Hydro unit / Hydro unit HT.
- When strainer is not installed, sand, dust or rust debris may cause product breakage.
  - Make sure that the strainer mesh is made of stainless steel.
- 5) Water inlet pipe is located at the bottom part of the heat exchanger and the water outlet pipe is at the top part of the heat exchanger.
- 6) DVM Hydro unit / Hydro unit HT must be installed indoor at room temperature and the water inlet and outlet must be insulated as shown in the 'Water pipe installation system' diagram on page 22.
- 7) Damp-proof, cold reserving and insulation work must be done thoroughly to prevent condensation from forming on the surface of the product and drain pipes of indoor/outdoor units. When the necessary work is not done thoroughly, you will waste energy caused by thermal loss and may get property damage during cold seasons when water pipe freezes and bursts.
- 8) If you stop the product for long time or in night time, water pipe circuit may freeze naturally when the temperature around the DVM Hydro unit / Hydro unit HT is under 0 °C. When water pipe circuit freezes, it will cause damage to the plate type heat exchanger and therefore preventive measure must be taken according to the situation.
- Drain remaining water in the water pipe
  - Install self-regulating heat cable on the water pipes
  - If the product is installed in a place where surround temperature drops below 0 °C, use anti-freeze accordingly for freezing point depression.
- 9) Install number of auto air discharge valve at a point where air may remain within the pipe (such as vertical water pipe). If the air within the pipe is not discharged, it may cause performance decrease or corrosion on the product or pipes.
- 10) Following is the operation range of water.

Section		Outlet water temperature (°C)		Amount of water (ℓ/min)				
		ADN***BDE**	AM***FNBF**	ADN160BDE**	ADN320BDE**	ADN500BDE**	AM160FNBF**	AM250FNBF**
Standard condition	Cooling	18	-	48	92	150	-	-
	Heating	35	65				23	36
Operation range	Cooling	5~30	-	24~48	46~92	75~150	-	-
	Heating	20~50	25~80				14~46	14~72

- ▶ When the amount of cooling water is out of the operation range, stop the DVM Hydro unit / Hydro unit HT and take care of the cause before re-start the operation.
- ▶ Temperature of discharged water is very high so be careful not to come in contact with the body. Also, cover the external water pipe with appropriate insulator for insulation and preventing burns.



- 11) Water scale may occur on the plate type heat exchanger depending on the water quality and the type of plate heat exchanger so regular chemical cleaning is necessary. When installing water pipes, install a heat source water shut-off valve and also install the flushing pipe with a ball valves (for chemical cleaning) on the pipe installed between the shut-off valve and the outdoor unit.
- 12) Before trial operation, connect the cleaning pipes installed on inlet and outlet as shown in above illustration. Then, take appropriate measures (such as blind flange etc) to stop the circulation water from entering the outdoor unit plate type heat exchanger, and use circulating pump to remove foreign substance within the water pipes and clean the strainer. If you do not clean the strainer, foreign substances may accumulates on plate type heat exchanger and may break the heat exchanger or cause problem to it.
- 13) Make sure that water quality within the water pipe meets the standard of cooling water quality for refrigerating and air conditioning equipment.
  - Heat source water containing high level of foreign substances can cause water heat exchanger and pipe corrosion or creation of water scale. (Use the appropriate heat source water according to the below table)
  - If the make-up water is provide from any other source than local water supply, make sure to check the quality of water.
  - Strainer (which needs to be purchased separately) must be installed to the 'Water IN' pipes of the water pipe. If sand, dust or rust debris enters to water system, it may cause corrosion on metallic materials or blockage of the water heat exchanger and damage the heat exchanger.
  - If the existing thermal storage tank or pipes are used, foreign substances may block the plate type heat exchanger of the DVM Hydro unit / Hydro unit HT so, water quality and foreign substances must be managed.
- 14) Check that the total water volume in the installation, excluding the internal water volume of DVM Hydro unit / Hydro unit HT, is 20L minimum.

Section	Item	Closed circuit system		Effects		Recommended number for water quality inspection
		Heat source water	Make-up water	Corrosion	Scale	
Standard value	pH[25 °C]	7.0 ~ 8.0	7.0 ~ 8.0	0	0	Once a year
	Electric conductivity [25 °C] (mS/m)	30 and below	30 and below	0	0	
	Chloride ion (mg Cl <sup>-</sup> /L)	50 and below	50 and below	0		
	Sulfate ion (mg SO <sub>4</sub> <sup>2-</sup> /L)	50 and below	50 and below	0		
	M alkali level [pH 4.8](mg CaCO <sub>3</sub> /L)	50 and below	50 and below		0	
	Total hardness (mg CaCO <sub>3</sub> /L)	70 and below	70 and below		0	
	Calcium hardness (mg CaCO <sub>3</sub> /L)	50 and below	50 and below		0	
Ionized silica (mg SiO <sub>2</sub> /L)	30 and below	30 and below		0		
Reference	Iron (mg Fe/L)	1.0 and below	0.3 and below	0	0	
	Copper (mg Cu/L)	1.0 and below	1.0 and below	0		
	Sulfate ion(mg S <sup>2-</sup> /L)	Not to be detected	Not to be detected	0		
	Ammonium ion (mg NH <sub>4</sub> <sup>+</sup> /L)	0.3 and below	0.1 and below	0		
	Residual chlorine (mg Cl/L)	0.25 and below	0.3 and below	0		
	Free carbon dioxide (mg CO <sub>2</sub> /L)	0.4 and below	0.4 and below	0		
	Stability index	-	-	0	0	

# Water pipe installation



NOTE

- Circle (O) marks in the chart show the factor relevant to corrosion or water scale.
- When the water temperature is over 40°C, steels without protective coating may corrode when expose to water. Applying corrosion prevention material or degassing can be effective measure to prevent corrosion.
- For the cooling water and the make-up water, used under closed circuit water system with closed circuit cooling tower, should satisfy the standard shown in above table.
- Supplied water or make-up water should be tap water, industrial water. Purified water, neutralized water and softened water should not be supplied.
- 15 items in the above table is a typical factor for corrosion and/or water scale.
- When water pipe circuit freezes, it will cause breakage on the plate type heat exchanger. Therefore appropriate preventive measure must be taken according to the situation.
  - Drain remaining water in the water pipe
  - Constantly operate the water pump to circulate the water within the water pipe
  - Install a self-regulating heat cable on the water pipe
- Open the valve of the water pipe connected to the outdoor unit after flushing (cleaning foreign substances in water pipe) is completed.
- Check that air is vented from the water pipe and circulation amount is secured before opening the service valve on the refrigerant side of the outdoor unit.
- When circulating water stops during outdoor nit operation, it may cause breakage on plate type heat exchanger.

## Pressure drop graphs

▶ ADN160BDE\*\* / AM160FNBD\*\*

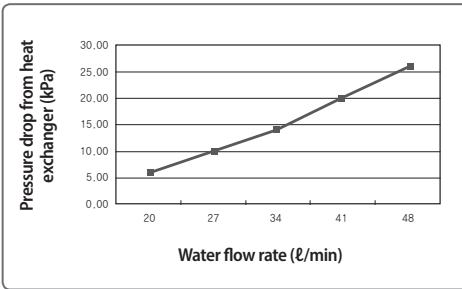

▶ ADN320BDE\*\* / AM320FNBD\*\*

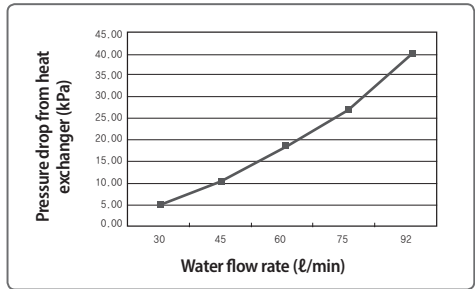

▶ ADN500BDE\*\* / AM500FNBD\*\*

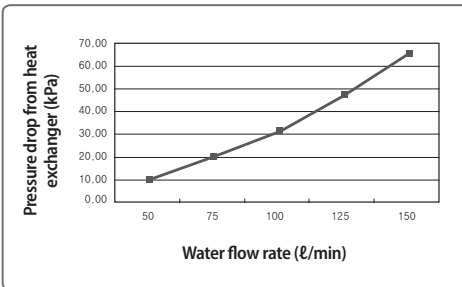

▶ AM\*\*\*FNBF\*\* / AM\*\*\*TNBF\*\*

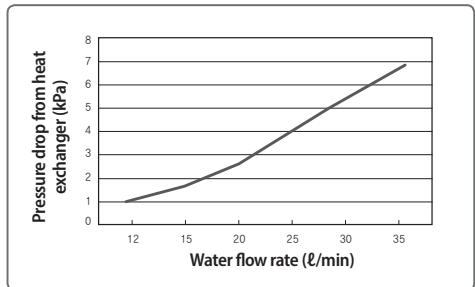

## Connecting strainer

- ▶ Use a strainer with 50 mesh (Diameter of each hole must be under 0.4 mm, excluding punching plate)
- ▶ Connect the strainer after checking the direction of the strainer on the water inlet hole as shown in the illustration.
- ▶ Wind the Teflon tape more than 15 times on the thread of the water pipe before connecting it.
- ▶ Service port must face downward and angle should be within 45° on the left and the right side.
- ▶ After installing the strainer, makes sure that there is no water leakage on the connection part.
- ▶ For normal operation of the product, clean the strainer regularly (more than once a year).

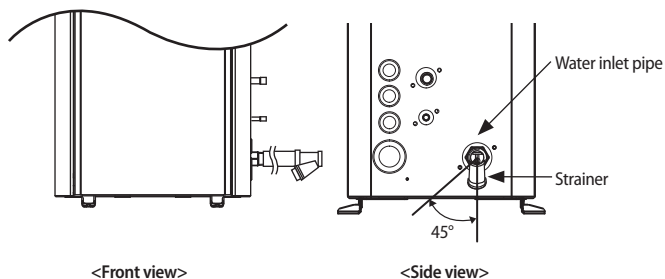

## Connecting power and communication cable

### Specification of electric wires

Indoor unit	Power supply	MCCB [A]	ELB [A]	Power cable (mm <sup>2</sup> )	Earth cable (mm <sup>2</sup> )	Communication cable (mm <sup>2</sup> )
DVM Hydro unit	1Ø, 220~240 V/50 Hz Max : 264 V Min : 198 V	X [A]	X [A], 30 mA, 0.1 sec ↓	2.5 mm <sup>2</sup> ↑ (Single Installation)	2.5 mm <sup>2</sup>	0.75~1.5 mm <sup>2</sup>
DVM Hydro unit HT	1Ø, 220~240 V/50 Hz Max : 264 V Min : 198V	X [A]	X [A], 30 mA, 0.1 sec ↓	4.0 mm <sup>2</sup> ↑ (Single Installation)		
	3Ø, 380~415 V/50 Hz Max : 456.5 V Min : 342 V	X [A]	X [A], 30 mA, 0.1 sec ↓	2.5 mm <sup>2</sup> ↑ (Single Installation)		

This Equipment complies with IEC 61000-3-12, provided that the short-circuit power  $S_{sc}$  is greater than or equal to 3.881 M at the interface point between the user's supply and the public system. It is responsibility of the installer or user of the equipment to ensure, by consultation with the distribution network operator if necessary that the equipment is connected only to a supply with a short-circuit power  $S_{sc}$  greater than or equal to 3.881 M

# Connecting power and communication cable

\* Table for current (Single installation)

Indoor unit	Model	Rated current (A)	MCA (A)	MFA (Min. ELCB, MCCB, A)
DVM Hydro unit	ADN***BDE**	0.05	2.2	2.75
	AM***FNBD**			
DVM Hydro unit HT	AM160FNBFE*	14.3	24.15	30.19
	AM250FNBFE*	23.1	32.15	40.19
	AM160FNBFG*	4.85	12.88	16.1
	AM250FNBFG*	7.85	12.88	16.1
	AM160TNBFE*	14.3	18.0	25.0
	AM250TNBFE*	23.1	30.0	40.0
	AM160TNBFG*	4.85	16.1	20.0
	AM250TNBFG*	7.85	16.1	20.0

► Decide the power cable specification and maximum length within 10 % power drop among indoor units.

$$\sum_{k=1}^n \left( \frac{\text{Coef} \times 35.6 \times L_k \times i_k}{1000 \times A_k} \right) < 10\% \text{ of input voltage [V]}$$

- coef : 1.55
- L<sub>k</sub> : Distance among each indoor unit [m], A<sub>k</sub> : Power cable specification [mm<sup>2</sup>]
- i<sub>k</sub> : Running current of each unit [A]

## Example of Installation

- Total power cable length L = 100(m), Running current of each units 1[A]
- Total 10 indoor units were installed

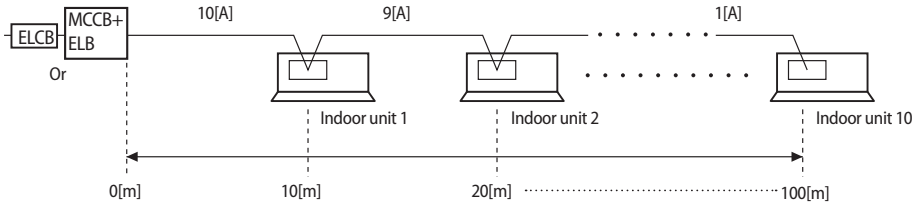

► Apply following equation

$$\sum_{k=1}^n \left( \frac{\text{Coef} \times 35.6 \times L_k \times i_k}{1000 \times A_k} \right) < 10\% \text{ of input voltage [V]}$$

\* Calculation

- Installing 1 type of wire.

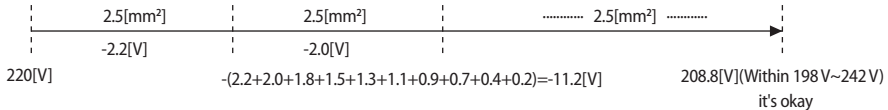

- Installing with 2 different sort wire.

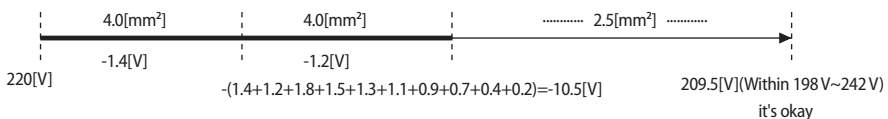

## Overall system configuration

DVM Hydro unit / Hydro unit HT use 220~240V or three phase, 380~415V (DVM Hydro unit HT)

### DVM Hydro unit

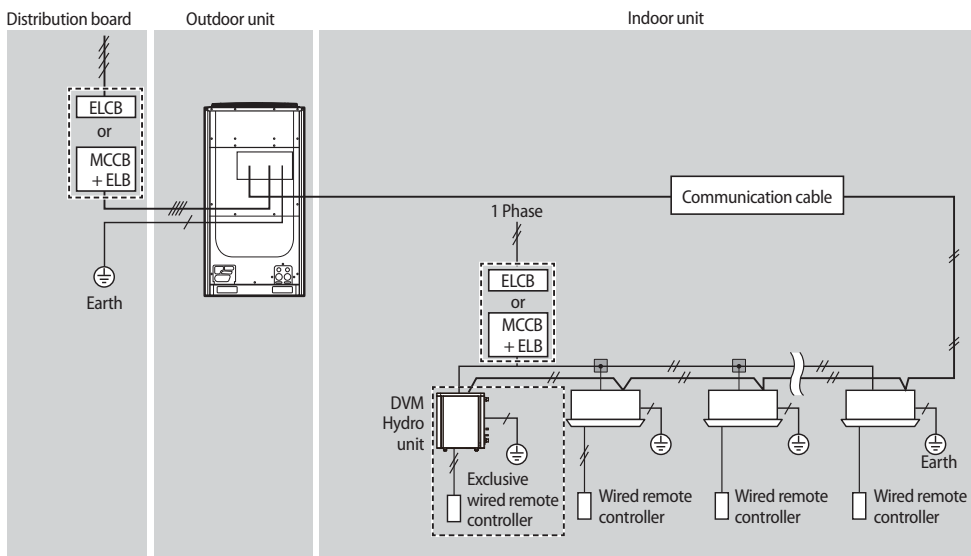

# Connecting power and communication cable

## DVM Hydro unit HT

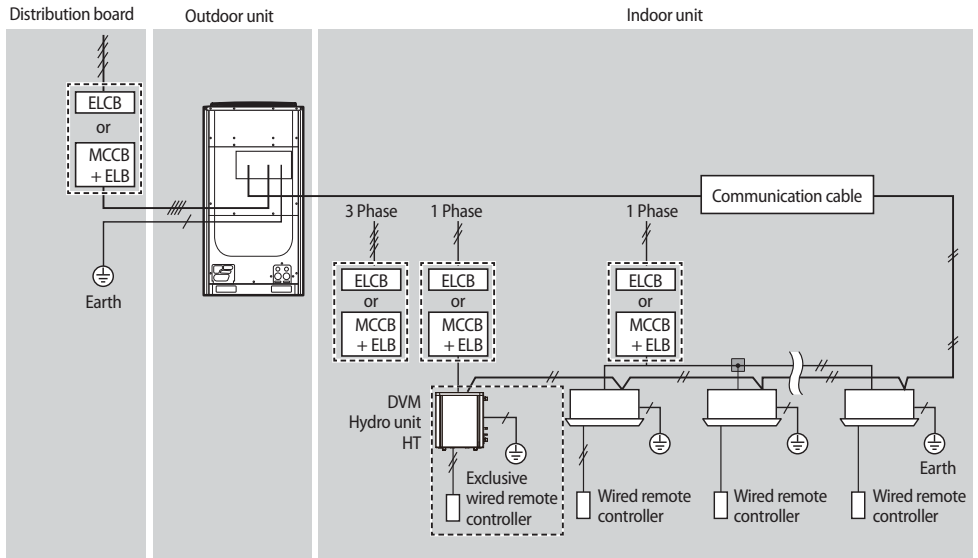

- Do not divide communication cable multiple times from one indoor/DVM Hydro unit / Hydro unit HT to another. It may cause communication error.
- Do not divide power cable multiple times from one Hydro unit HT to another. DVM Hydro unit HT can get a damage.
- Power supply cords of parts of appliances for outdoor use shall not be lighter than polychloroprene sheathed flexible cord. (Code designation IEC:60245 IEC 57 / CENELEC: H05RN-F) (ADN\*\*\*BDE\*\* / AM\*\*\*FNBD\*\* Model)
- Power supply cords of parts of appliances for outdoor use shall not be lighter than polychloroprene sheathed flexible cord. (Code designation IEC:60245 IEC 66 / CENELEC: H07RN-F) (AM\*\*\*FNBF\*\* / AM\*\*\*TNBF\*\* Model)

## Power supply and communication cable configuration

- ▶ Withdraw a main power cable and a grounding cable through the cable outlet on the right side of the DVM Hydro unit / Hydro unit HT.
- ▶ When connecting external contact signal wire, connect them to the PCB terminal board through the cable outlets in the right side of the outdoor unit.
- ▶ Wires must be installed after putting them in separate cable protection tubes.
- ▶ Fix a cable tube at the cable outlet using a CD connector.

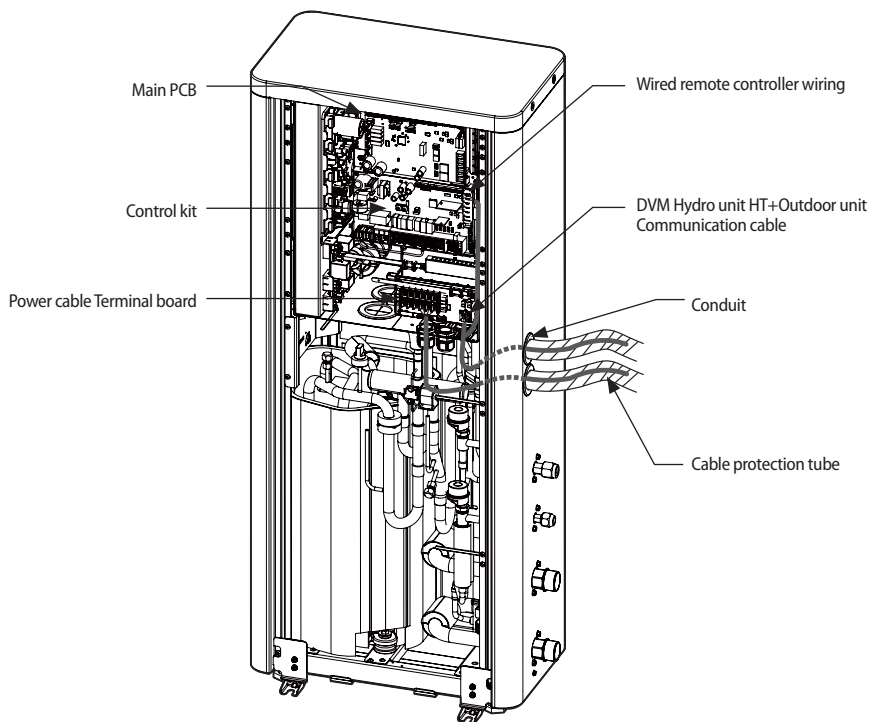
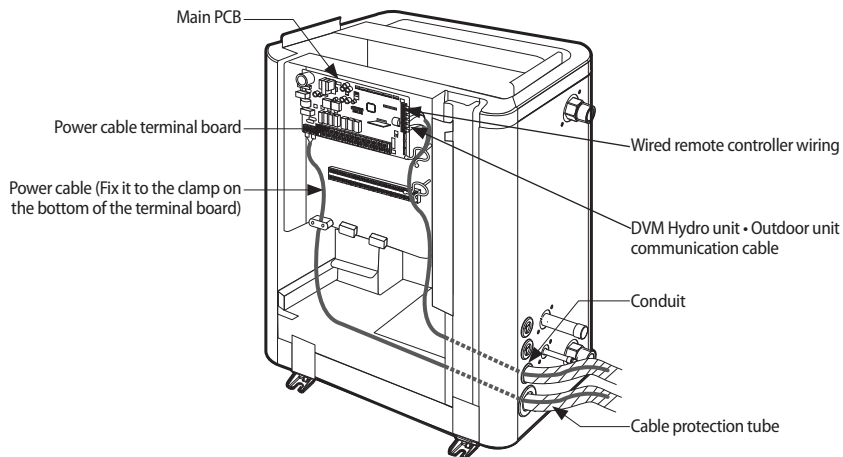

# Connecting power and communication cable

## Specifications of the cable protection tube

Name	Material	Applicable conditions
Flexible PVC conduit	PVC	When the cable tube is installed indoor and not exposed to outside, because it is embedded in concrete structure
Class 1 flexible conduit	Galvanized steel sheet	When the cable tube is installed indoor but exposed to outside so there are risk of damage to the cable tube
Class 1 PVC coated flexible conduit	Galvanized steel sheet and Soft PVC compound	When the cable tube is installed outdoor and exposed to outside so there are risk of damage to the cable tube and extra waterproof is needed

## Power and communication wiring diagram

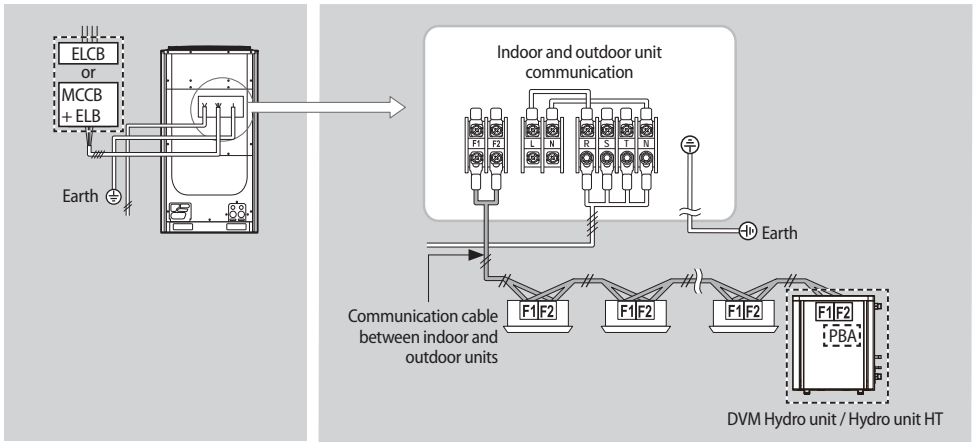

- ▶ The communication cable between indoor and outdoor units has no polarity.
- ▶ Arrange the cables using a clamp attached on the left side of the terminal board.
- ▶ When you connect the power cable, you must apply rated tightening torque to connect the screws for the terminal board.



## PBA connection diagram

### ► ADN\*\*\*BDE\*\*

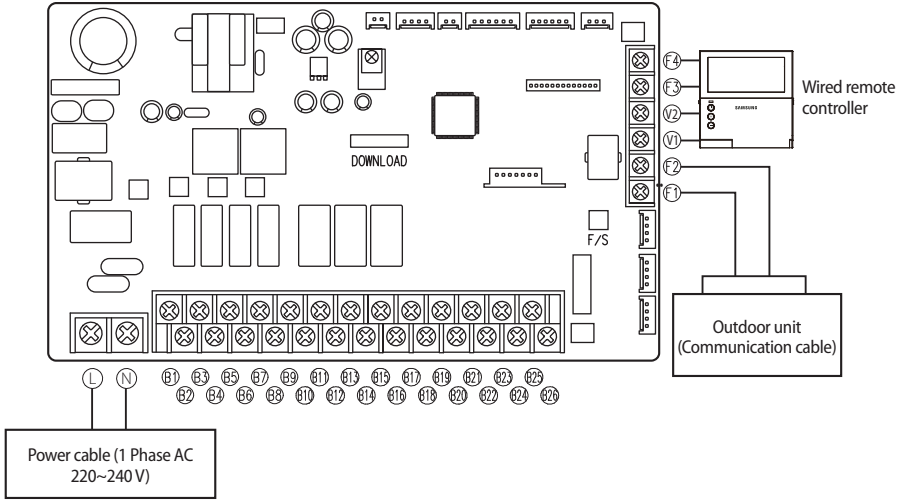

### ► AM\*\*\*FNBD\*\*

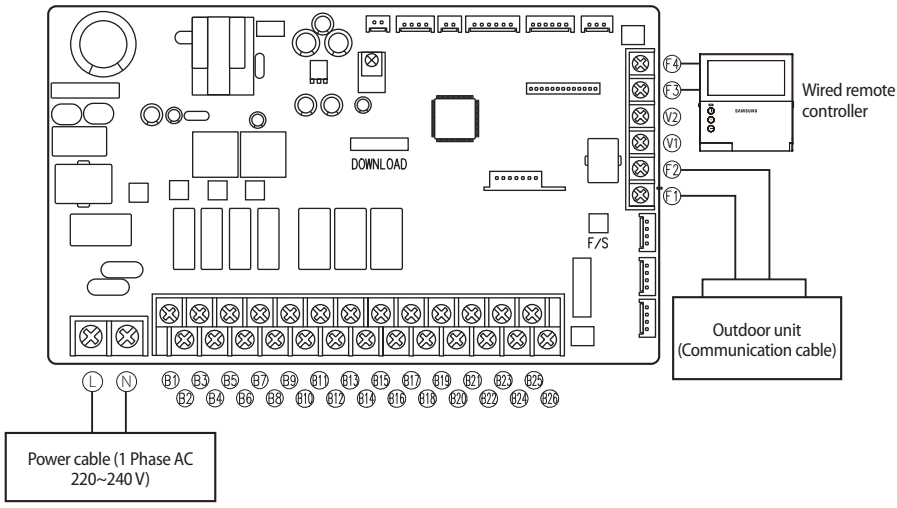

# Connecting power and communication cable

▶ AM\*\*\*FNBF\*\* / AM\*\*\*TNBF\*\*

- Single phase

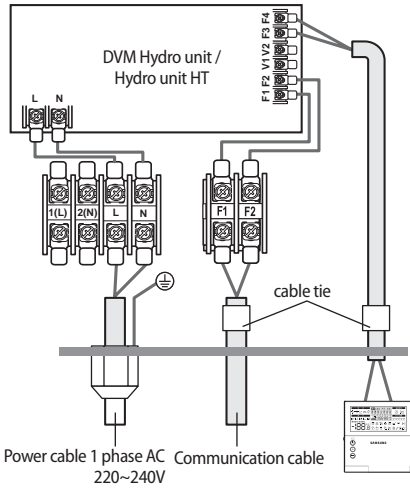

- Three phase

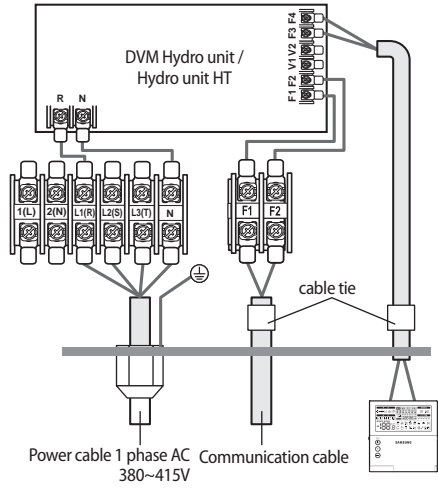

# Wiring diagram for connecting 2 wired remote controllers

## ► ADN\*\*\*BDE\*\*

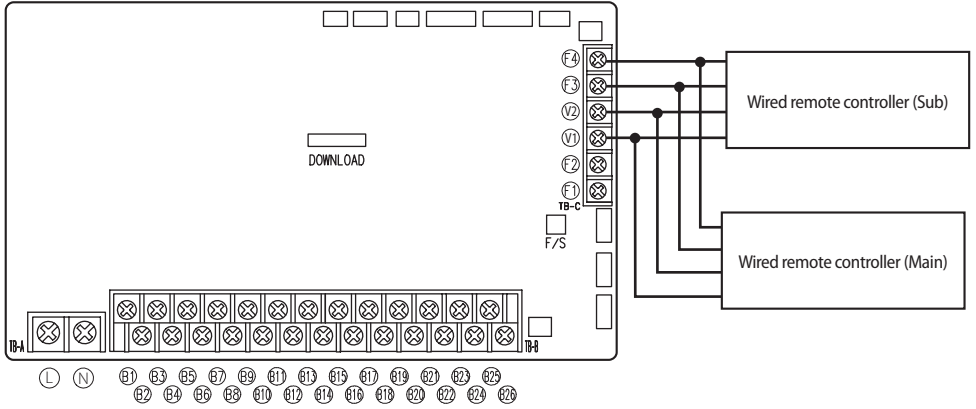

## ► AM\*\*\*FNBD\*\* / AM\*\*\*FNBF\*\* / AM\*\*\*TNBF\*\*

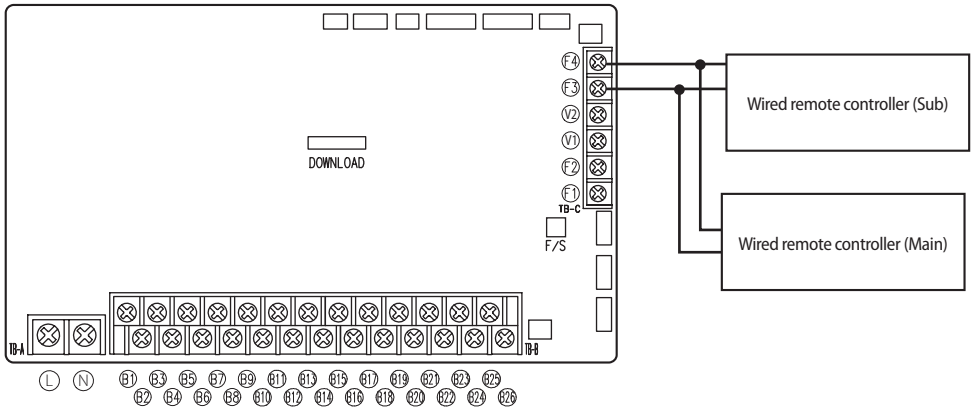

# Connecting power and communication cable

## Connecting the power terminal

- ▶ Connect the cables to the terminal board using a solderless ring terminal.
- ▶ Properly connect the cables by using certified and rated cables and make sure to fix them properly so that external force is not applied to the terminal.
- ▶ Use a driver and wrench that can apply the rated torque when tightening the screws on the terminal board.
- ▶ Tighten the terminal screws by complying rated torque value. If the terminal is loose, arc heat may occur and cause fire and if the terminal is connected too firmly, terminal may get damaged.

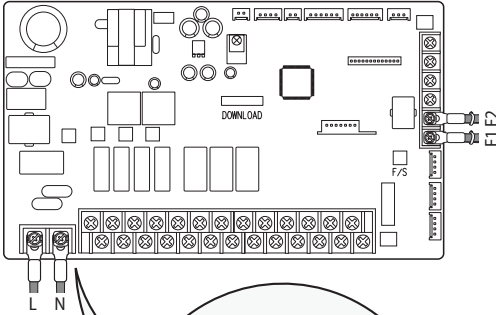

Connect one cable per terminal and fix it with a solderless terminal.

Terminal name	Tightening Torque (N·m)	
External contact	M3	0.5~0.75
Communication	M3.5	0.8~1.2
Power	M4	1.2~1.8

<DVM Hydro unit >

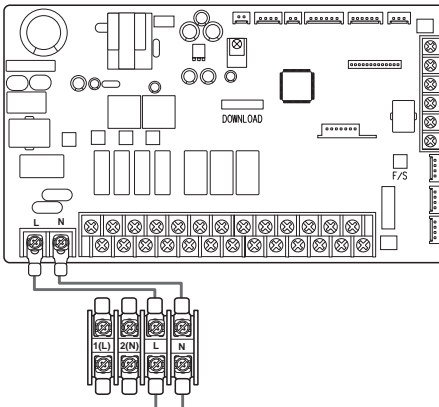

<DVM Hydro unit HT>

## Selecting solderless ring terminal

- ▶ Select a solderless ring terminal for a power cable according to the nominal dimensions for cable.
- ▶ Apply insulation coating to the connection part of the solderless ring terminal and the power cable.

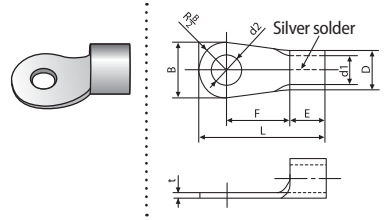





Nominal dimensions for cable (mm <sup>2</sup> )		1.5		2.5			10	16
Nominal dimensions for screw (mm)		4	5	4	5	5	5	
B	Standard dimension (mm)	6.6	8	6.6	8.5	9.5	12	12
	Allowance (mm)	±0.2		±0.2			±0.2	±0.2
D	Standard dimension (mm)	3.4		4.2			7.1	9
	Allowance (mm)	+0.3	-0.2	+0.3	-0.2	+0.3	-0.2	+0.3
d1	Standard dimension (mm)	1.7		2.3			4.5	5.8
	Allowance (mm)	±0.2		±0.2			±0.2	±0.2
E	Min.	4.1		6			7.9	9.5
F	Min.	6	7	6	7	6	9.5	
L	Max.	16		17.5			24	30
d2	Standard dimension (mm)	4.3	5.3	4.3	5.3	5.3	5.3	
	Allowance (mm)	+0.2	+0.2	+0.2	+0.2	+0.2	+0.2	
t	Min.	0		0			0	0
	Min.	0.7		0.8			1.15	1.45

# Connecting power and communication cable

## How to connect your extended power cables

1. Prepare the following tools.

Tools	Crimping pliers	Connection sleeve (mm)	Insulation tape	Contraction tube (mm)
Spec	MH-14	20xØ6.5 (HxOD)	Width 19 mm	70xØ8.0 (LxOD)
Shape				

2. As shown in the figure, peel off the shields from the rubber and wire of the power cable.

- Peel off 20 mm of cable shields from the pre-installed tube.



- For information about the power cable specifications for indoor and outdoor units, refer to the installation manual.
- After peeling off cable wires from the pre-installed tube, insert a contraction tube.

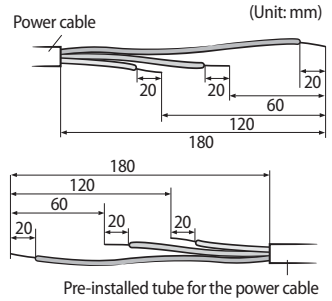

3. Insert both sides of core wire of the power cable into the connection sleeve.

### ► Method 1

Push the core wire into the sleeve from both sides.

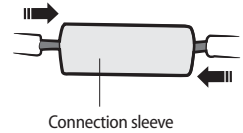

### ► Method 2

Twist the wire cores together and push it into the sleeve.

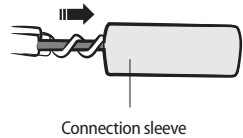

- If cable wires are connected without using connecting sleeves, their contact area becomes reduced, or corrosion develops on the outer surfaces of the wires (copper wires) over a long time. This may cause an increase of resistance (reduction of passing current) and consequently may result in a fire.

4. Using a crimping tool, compress the two points and flip it over and compress another two points in the same location.

- The compression dimension should be 8.0.

- After compressing it, pull both sides of the wire to make sure it is firmly pressed.

### ► Method 1

Compress it 4 times.

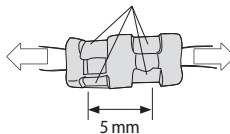

### ► Method 2

Compress it 4 times.

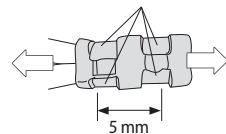

5. Apply heat to the contraction tube to contract it.

► **Method 1**

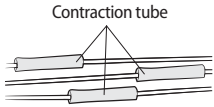

► **Method 2**

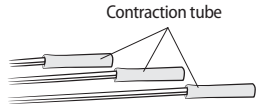

6. Wrap it with the insulation tape twice or more and position your contraction tube in the middle of the insulation tape.

► **Method 1**

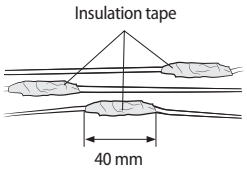

► **Method 2**

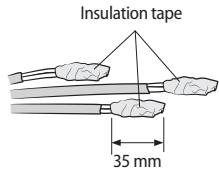

7. After tube contraction work is completed, wrap it with the insulation tape to finish. Three or more layers of insulation are required.

► **Method 1**

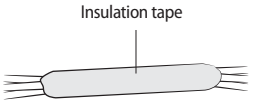

► **Method 2**

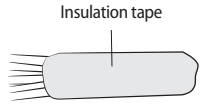

CAUTION

- Make sure that the connection parts are not exposed to outside.
- Be sure to use insulation tape and a contraction tube made of approved reinforced insulating materials that have the same level of withstand voltage with the power cable. (Comply with the local regulations on extensions.)



WARNING

- In case of extending the electric wire, please DO NOT use a round-shaped Pressing socket.
- Incomplete wire connections can cause electric shock or a fire.

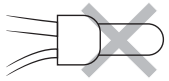

# Connecting external contact

## External contact connection diagram

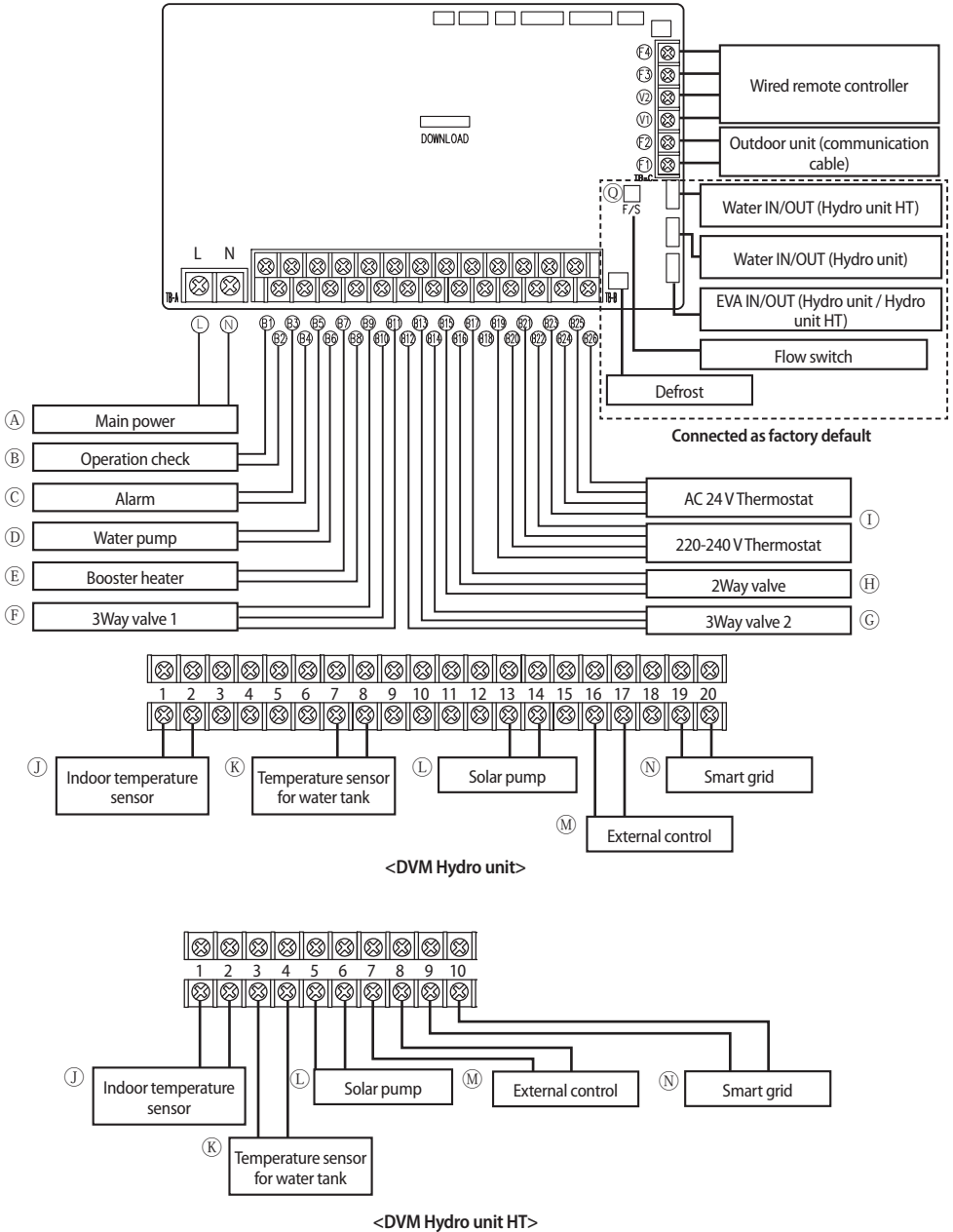



Explanation		Terminal No.	Input / Output	AC/DC	Maximum allowable current
A	Power	L, N	Input	AC	2.5 A
B	Operation check	B1, B2	Contact output	-	0.5 A
C	Alarm	B3, B4	Contact output	-	0.5 A
D	Water pump	B5, B6	Contact output	-	0.5 A
E	Booster heater	B7, B8	Contact output	-	0.5 A
F	3Way valve 1	B9 ~ B11	Output	AC	0.5 A
G	3Way valve 2	B12 ~ B14	Output	AC	0.5 A
H	2Way valve	B15 ~ B17	Output	AC	0.5 A
I	AC 230, AC 24 V Thermostat	B19 ~ B26	Input	AC	10 mA
J	Separately installed indoor temperature sensor (MRW-TA)	1,2(1,2)	Input	DC	1 mA
K	Temperature sensor for water tank	7,8(3,4)	Input	DC	20 mA
L	Solar pump	13,14(5,6)	Contact input	-	10 mA
M	External control	16,17(7,8)	Contact input	-	1 mA
N	Smart grid	19,20(9,10)	Input	DC	1 mA
O	Communication cable (RS485)	F1, F2	Input, Output	DC	10 mA
P	Wired remote controller	V1	Output	DC	210 mA (per each controller)
		V2	Grounding	-	-
		F3, F4	Input, Output	DC	10 mA
Q	Flow switch	F/S	Input	DC	1 mA

\* ( ) : Hydro unit HT

\* For instruction regarding on wiring power, communication and wired remote controller, refer to "Connecting power and communication cable" chapter.

\* External control: Operation On or Off by external contact signal

\* Smart grid: Set by remote controller FSV

FSV#5041 : Default is 0 (Disable)

FSV#5042 : 0 (default) While the external contact is maintained as High, disable all heat source (heater).

1 Use Booster Heater only

# Connecting external contact

► Refer to the below table for the terminal numbers that needs on the site for connecting external contact.

Terminal No.	External contact	Function	Remarks
B1, B2	Operation check	Output operation status	Optional
B3, B4	Alarm	Output alarm status	Optional
B5, B6	Water pump	Output operation signal for a water pump	Mandatory
B7, B8	Booster heater	Output operation signal for booster heater of DHW tank	Optional
B9~B11	3Way valve 1	Output 3 way valve direction signal for indoor heating / DHW selection	Optional
B12~B14	3Way valve 2	Output for solar pump interconnection/defrost signal interconnection	Optional
B15~B17	2Way valve	Output 2 way valve switching signal for blocking cold water fall in floor cooling	Optional
B19, B20	AC230, Thermostat 1	Input thermostat signal for cooling (AC 220-240 V)	Optional
B21, B22	AC230, Thermostat 2	Input thermostat signal for heating (AC 220-240 V)	Optional
B23, B24	AC24, Thermostat 1	Input thermostat signal for cooling (AC 24V)	Optional
B25, B26	AC24, Thermostat 2	Input thermostat signal for heating (AC 24V)	Optional
1, 2 (1, 2)	Indoor temperature sensor	Connect indoor temperature sensor (Connection status can be checked on the wired remote controller.)	Optional
7, 8 (3, 4)	Temperature sensor for water tank	Connect temperature sensor of DHW tank (Connection status can be checked on the wired remote controller.)	hot water supply operation
13, 14 (5, 6)	Solar pump	Input contact signal for solar heat pump operation	Optional
16, 17 (7, 8)	External control	Input external contact control signal (Refer to seg 14 of 02 series remote controller installation option.)	Optional
19, 20 (9, 10)	Smart grid	Input contact signal for smart grid	Optional

\* ( ): Hydro unit HT

\* You may need to set different field specifications for the wired remote controller depending on the function.

## Water pump connection

► Connect a water pump to B5, B6 of the PBA terminal block.

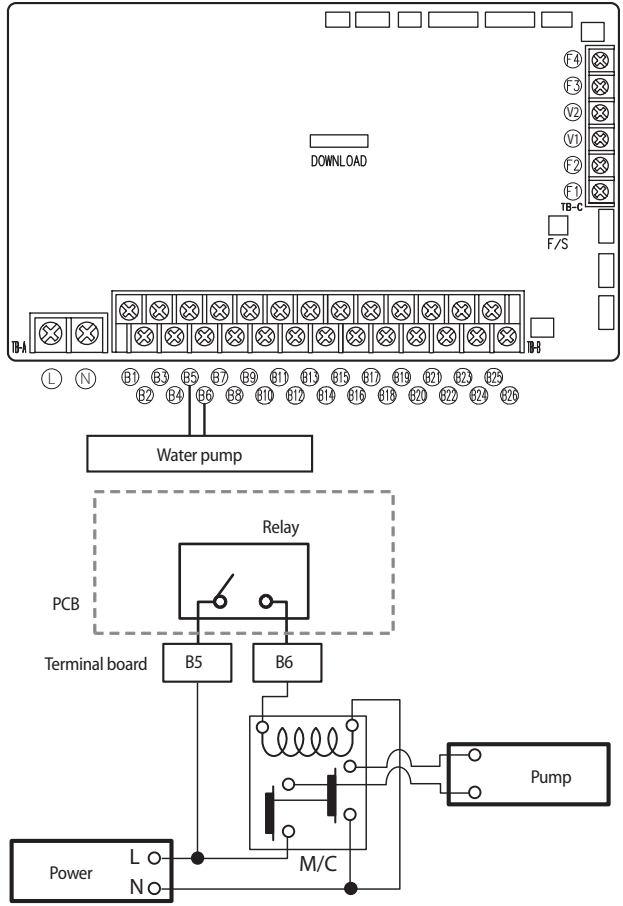

**CAUTION** • Terminal of this product is for water pump and the maximum allowable current is 0.5 A

### Specification table

Part	Specification
Terminal block (Output)	B5, B6
Connection type	Water pump (No-voltage contact)

# Connecting external contact

## Booster heater connection

- ▶ Connect a booster heater to B7, B8 of the PBA terminal block.

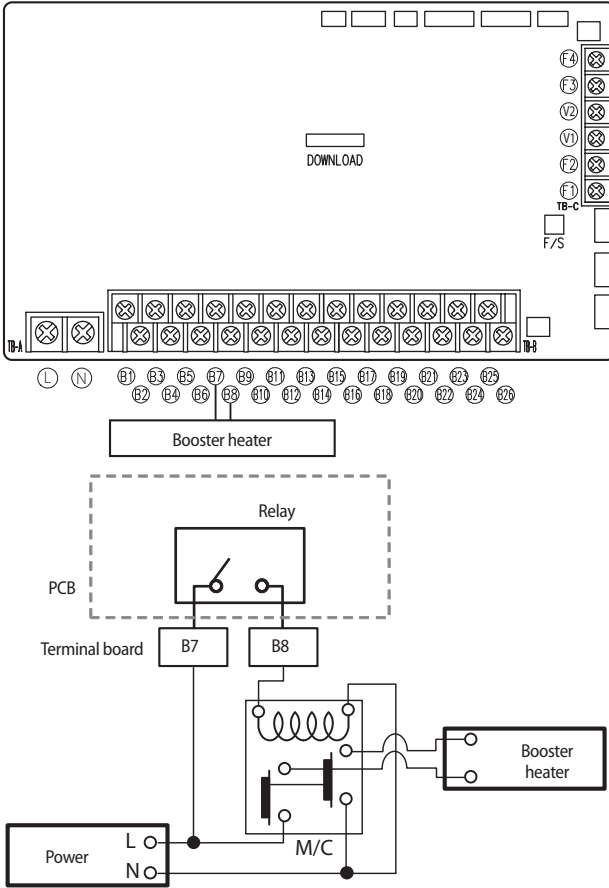

## Specification table

Part	Specification
Terminal block (Output)	B7, B8
Connection type	Booster heater (No-voltage contact)

### 3Way valve connection

- ▶ Check the type of 3Way valve and connect it to the terminal board as shown in the illustration.
- ▶ Use a rated wire and connect it as shown in the illustration.
- ▶ 3 Way valve 1: When the valve is connected to B9 and B11, its direction should be indoor side.
- ▶ 3 Way valve 2: When the valve is connected to B12 and B14, its direction should be tank side.

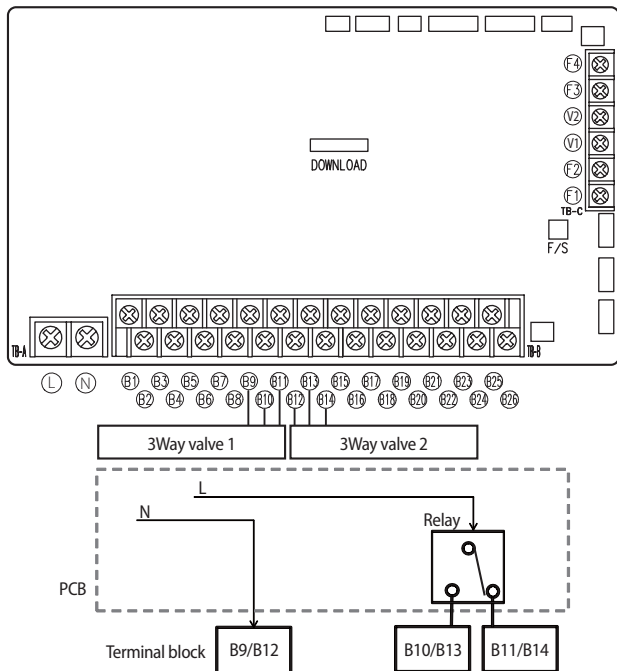

\* Initially, relay is connected between L and B11/B14 of the terminal block.



• Before completing installation of 3Way valve, check the opening direction of the port.

Part	Specification
Output (B9 ~ B11, B12 ~ B14)	AC 220 - 240 V (Max 0.5A / 120W)

### Allowed connection

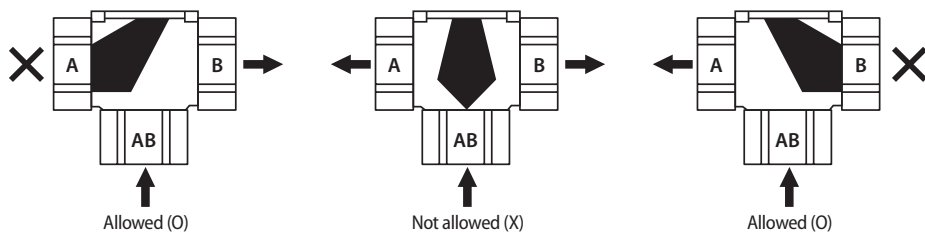

# Connecting external contact

## Example of installation (Danfoss H-series valve)

### ► Connecting the valve

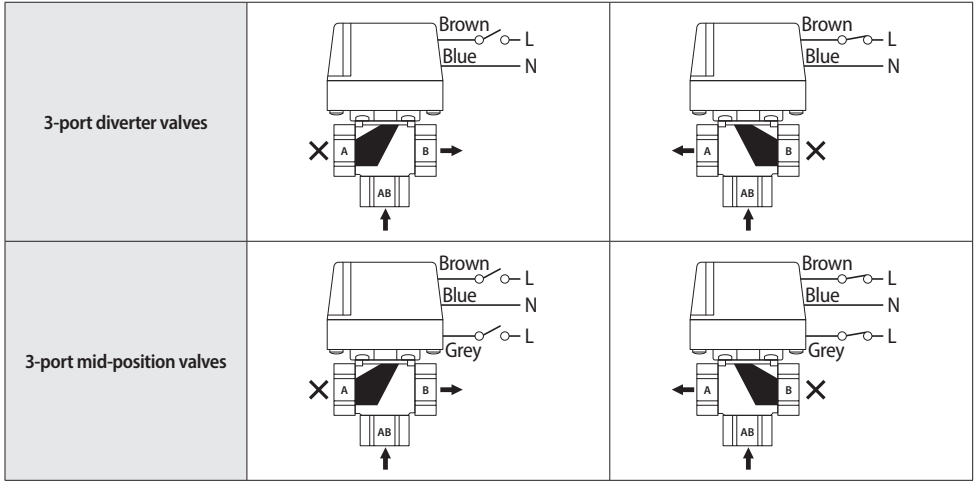

### ► Example of wiring

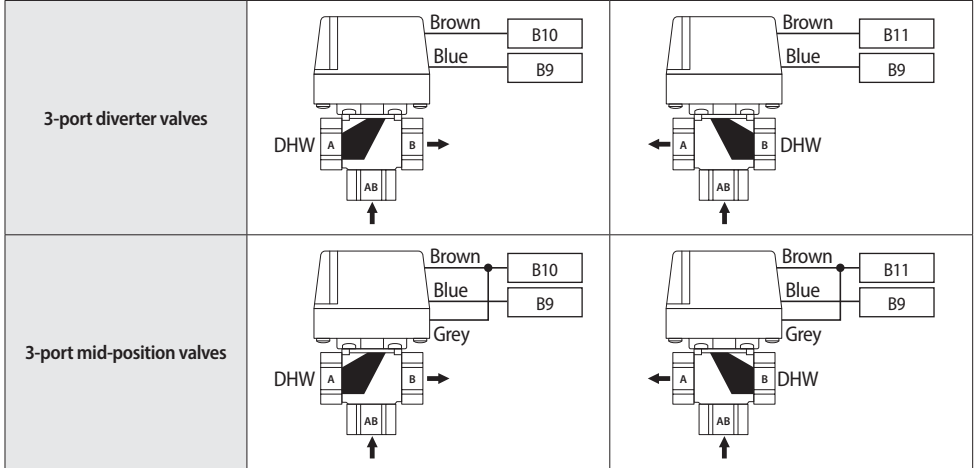

\* Connect B12/B13 (3 Way valve 2) of the terminal block to use the defrost mode contact output.

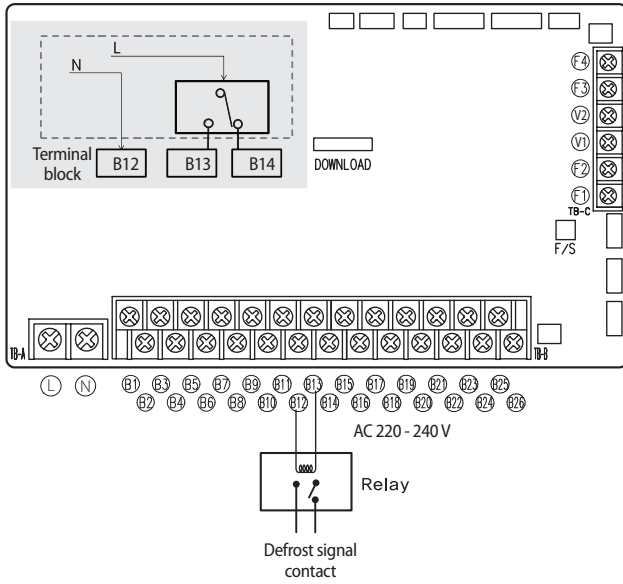





## Wiring 2Way valve

When floor cooling and fan coil unit cooling operate at the same time, 2 way valve prevent temperature drop of the floor.

- ▶ Use a rated wire to connect it as shown in the illustration and fix it with a cable tie.
- ▶ Initial setting of the valve is 'closed (no flow)'.

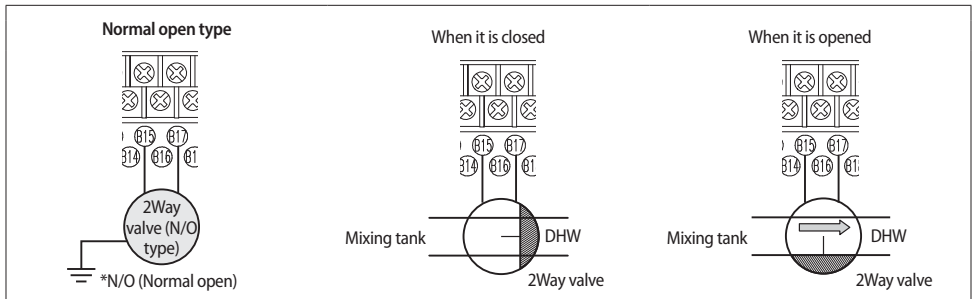
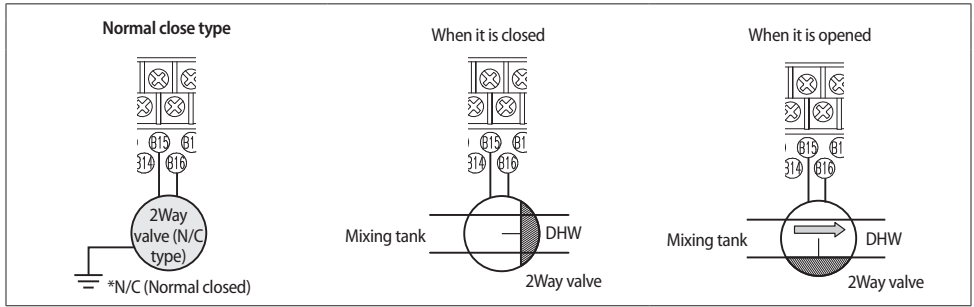

- Wiring is different for a N/C (Normal closed) valve and N/O (Normal open) valve.

# Connecting external contact

## AC 220-240 V or AC 24V thermostat

- ▶ Connect the indoor thermostat to B19~B26 of the PBA terminal block.
- ▶ Connect a thermostat to the designated terminal as stated in the rated table.
- ▶ Only 1 type of thermostat can be connected. (B19~B22 or B23~B26)
- ▶ Product will not operate when signal for cooling and heating mode is inputted at the same time.

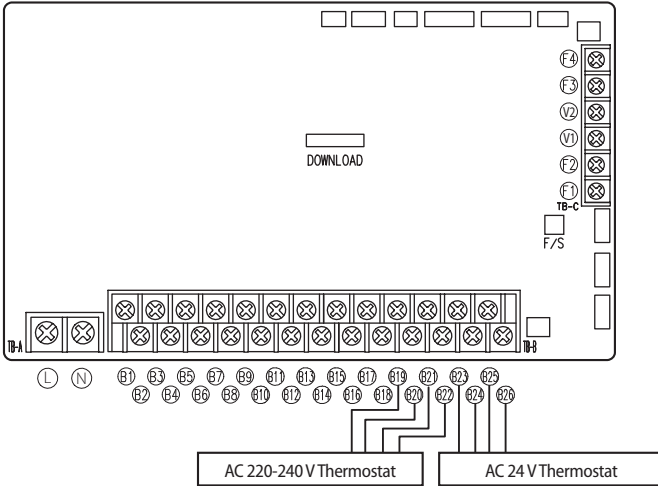

• Maximum allowable current of each terminal is below 10mA

## Specification table

Part	Specification
Terminal block (AC 220-240 V)	B19: Output power L (for cooling mode) B20: Input power N (for cooling mode) B21: Output power L (for heating mode) B22: Input power N (for heating mode)
Terminal block (AC 24V)	B23: Output power L (for cooling mode) B24: Input power N (for cooling mode) B25: Output power L (for heating mode) B26: Input power N (for heating mode)
Connection type	Connect to indoor power controller
Input (B19~B22)	AC 220-240 V (Maximum 10 mA)
Input (B23~B26)	AC 24 V (Maximum 10 mA)
Condition for operation	When B20 or B24 is detected -> cooling mode When B22 or B26 is detected -> heating mode

## AC 220-240 V thermostat

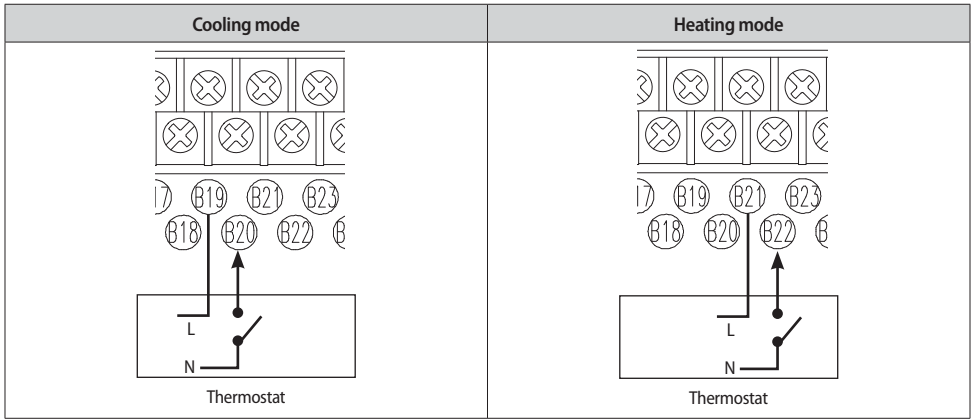

## AC 24 V thermostat

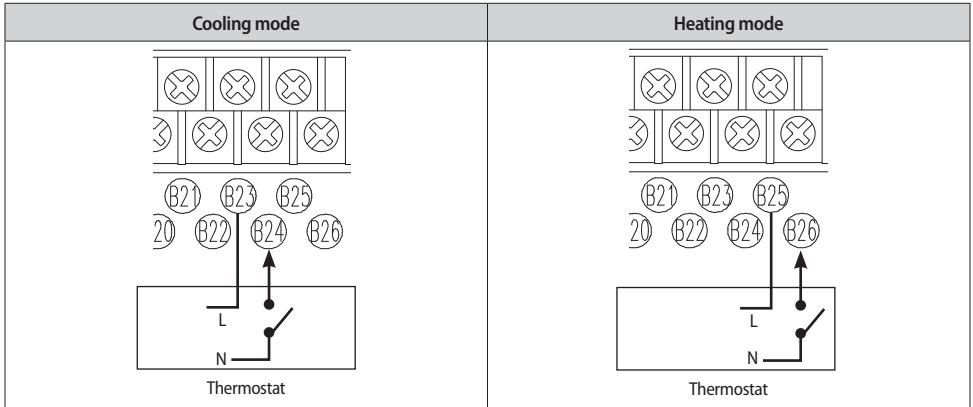

# Connecting external contact

## Connecting temperature sensor of water tank and flow switch

- ▶ Connect the temperature sensor of water tank to number 7 and 8 of the terminal block located on the bottom side.
- ▶ Connect 4~20 mA temperature sensor for water tank. When there is more than one unit, at least one of them should be connected directly to the temperature sensor.

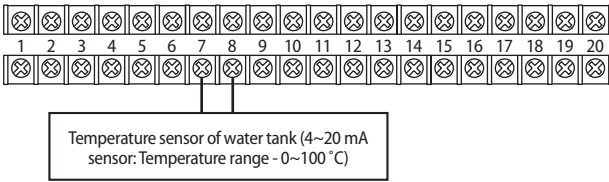
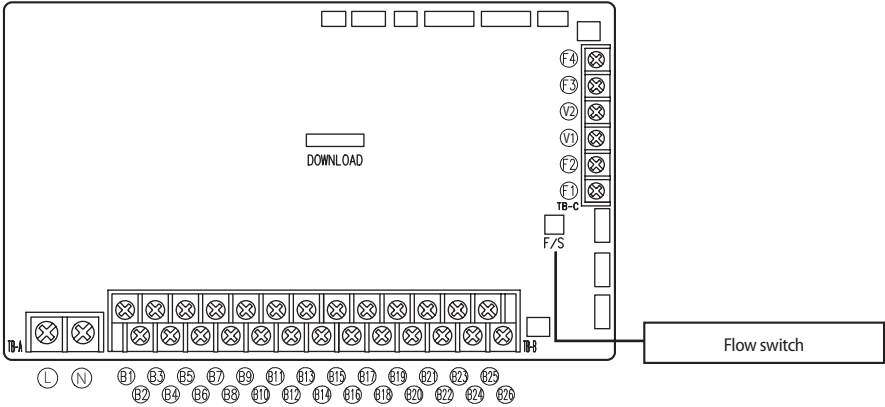

<DVM Hydro unit>

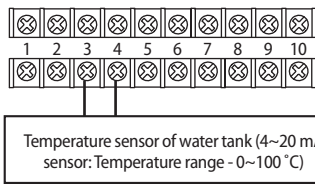
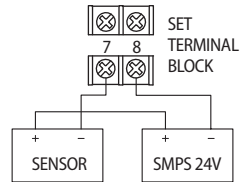

<DVM Hydro unit HT>

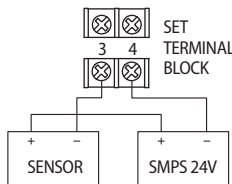

## Connecting solar pump

- ▶ Connect the signal wire for solar pump to number 13 and 14 (HT: 5. 6) of the terminal block located on the bottom side.

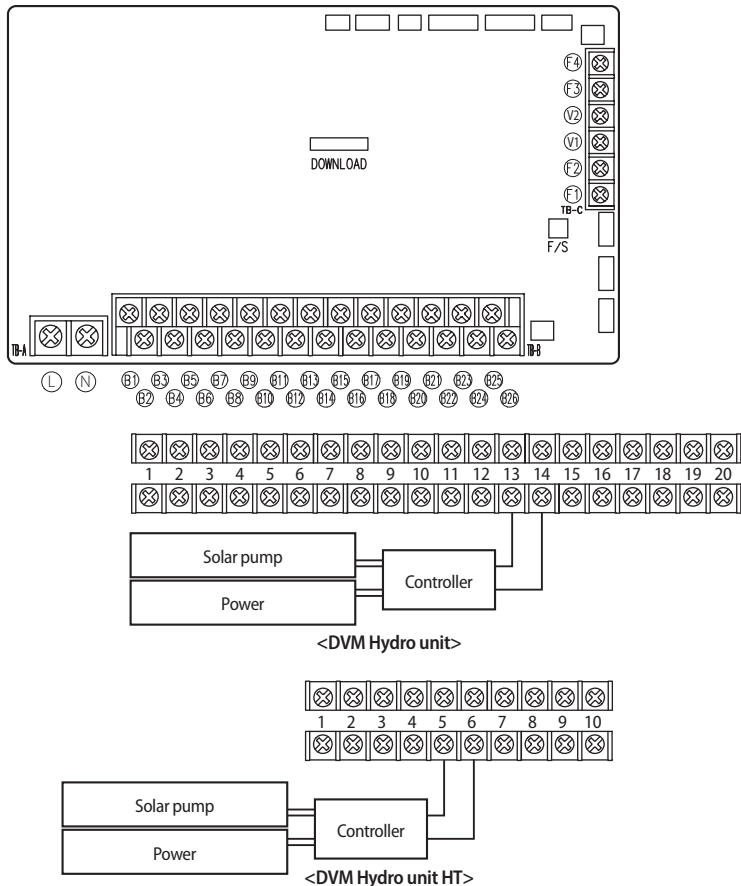

- Maximum allowable current of each terminal is below 10 mA.
- Ports number 13 and 14 (HT: 5. 6) is for input port for detection and they do not supply power to a solar pump.

## Specification table

Part	Specification
Terminal block (Input)	13 and 14 (HT: 5. 6): No-voltage contact
Connection type	Connect to solar pump controller (contact signal)

# Connecting external contact

## Grounding work

A ground rod must be installed if the grounding terminal on the power circuit does not exist or meet the standard. Additional accessories required for installation must be purchased separately since they are not supplied with DVM Hydro unit / Hydro unit HT.

1. Prepare a ground rod that matches the one shown in the illustration.

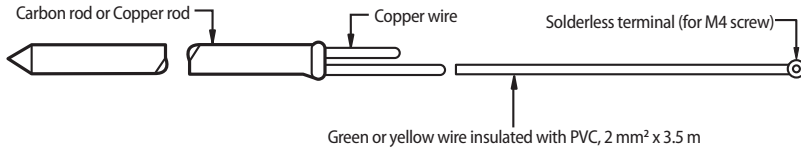

2. Select an appropriate place to install a ground rod.

- It is better to select a damp and firm ground than sandy ground or ground with gravels which is high-resisting.
- Avoid place with underground structure or facilities. (Gas pipe, water pipe, phone lines, or underground cable)
- Place has to be at least 2 m away from the lightning rod.

\* Ground wire for phone lines cannot be used for grounding DVM Hydro unit / Hydro unit HT.

3. Install a green or yellow ground wire.

- Refer to the illustration on step 1 for the specification of a ground rod.
- If the ground wire is too short, it can be extended but connected part (where extended wire is connected) must be wrapped with insulation tape. (Do not bury the connected part underground.)
- Fix the ground wire.

\* Ground wire must be fixed firmly when it is installed at a place with lots of passerby.

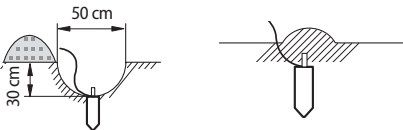

4. Check the ground resistance with an earth resistance tester to see if installation is done properly.

- If the resistance value exceeds requirement, place the ground rod deeper or add more ground rods.

5. Connect the ground wire to the terminal block of DVM Hydro unit / Hydro unit HT.

# Setting an indoor unit address and installation option

- ▶ Set the indoor unit address and installation option with remote controller option.  
Set the each option separately since you cannot set the ADDRESS setting and indoor unit installation setting option at the same time. You need to set twice when setting indoor unit address and installation option.

## The procedure of option setting

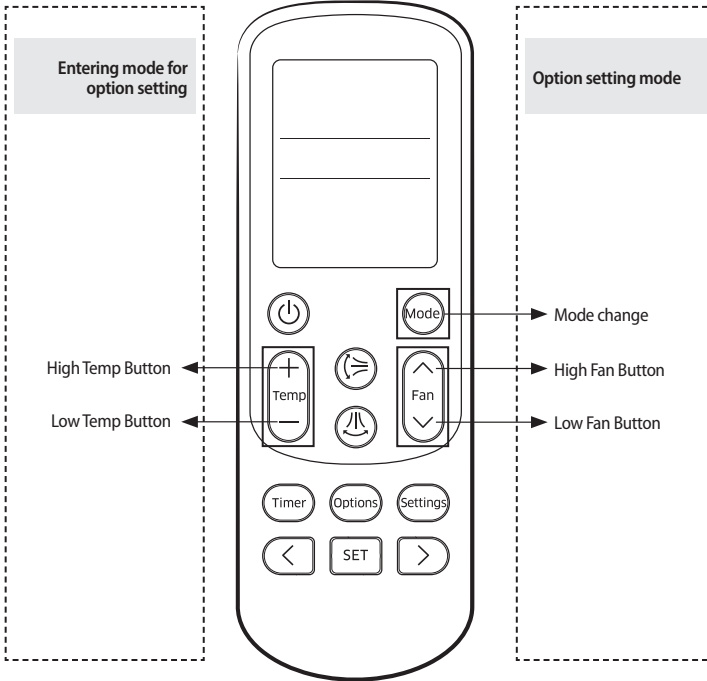

### Step 1. Entering mode to set option

1. Remove batteries from the remote controller.
2. Insert batteries and enter the option setting mode while pressing High Temp button and Low Temp button.
3.  Check if you have entered the option setting status.

### Step 2. The procedure of option setting

After entering the option setting status, select the option as listed below.















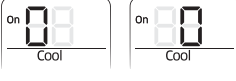

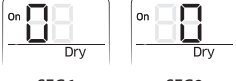
Option setting is available from SEG1 to SEG24

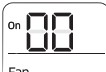
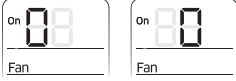
- SEG1, SEG7, SEG13, SEG19 are not set as page option.
- Set the SEG2~SEG6, SEG8~SEG12 as ON status and SEG14~18, SEG20~24 as OFF status.





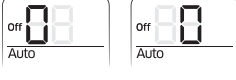





SEG1	SEG2	SEG3	SEG4	SEG5	SEG6	SEG7	SEG8	SEG9	SEG10	SEG11	SEG12
0	X	X	X	X	X	1	X	X	X	X	X
SEG13	SEG14	SEG15	SEG16	SEG17	SEG18	SEG19	SEG20	SEG21	SEG22	SEG23	SEG24
2	X	X	X	X	X	3	X	X	X	X	X

On(SEG1~12)	Off(SEG13~24)
On 00 Auto	Off 00 Auto

# Setting an indoor unit address and installation option

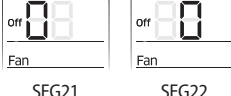
Option setting	Status
<p>1. Setting SEG2, SEG3 option</p> <p>Press Low Fan button(∨) to enter SEG2 value.</p> <p>Press High Fan button(∧) to enter SEG3 value.</p> <p>Each time you press the button, 0 → 1 → ... 8 → F will be selected in rotation.</p>	 <p>SEG2                  SEG3</p>
<p>2. Setting Cool mode</p> <p> Press Mode button to be changed to Cool mode in the ON status.</p>	
<p>3. Setting SEG4, SEG5 option</p> <p>Press Low Fan button(∨) to enter SEG4 value.</p> <p>Press High Fan button(∧) to enter SEG5 value.</p> <p>Each time you press the button, 0 → 1 → ... 8 → F will be selected in rotation.</p>	 <p>SEG4                  SEG5</p>
<p>4. Setting Dry mode</p> <p> Press Mode button to be changed to DRY mode in the ON status.</p>	
<p>5. Setting SEG6, SEG8 option</p> <p>Press Low Fan button(∨) to enter SEG6 value.</p> <p>Press High Fan button(∧) to enter SEG8 value.</p> <p>Each time you press the button, 0 → 1 → ... 8 → F will be selected in rotation.</p>	 <p>SEG6                  SEG8</p>
<p>6. Setting Fan mode</p> <p> Press Mode button to be changed to FAN mode in the ON status.</p>	
<p>7. Setting SEG9, SEG10 option</p> <p>Press Low Fan button(∨) to enter SEG9 value.</p> <p>Press High Fan button(∧) to enter SEG10 value.</p> <p>Each time you press the button, 0 → 1 → ... 8 → F will be selected in rotation.</p>	 <p>SEG9                  SEG10</p>
<p>8. Setting Heat mode</p> <p> Press Mode button to be changed to HEAT mode in the ON status.</p>	
<p>9. Setting SEG11, SEG12 option</p> <p>Press Low Fan button(∨) to enter SEG11 value.</p> <p>Press High Fan button(∧) to enter SEG12 value.</p> <p>Each time you press the button, 0 → 1 → ... 8 → F will be selected in rotation.</p>	 <p>SEG11                  SEG12</p>
<p>10. Setting Auto mode</p> <p> Press Mode button to be changed to AUTO mode in the OFF status.</p>	
<p>11. Setting SEG14, SEG15 option</p> <p>Press Low Fan button(∨) to enter SEG14 value.</p> <p>Press High Fan button(∧) to enter SEG15 value.</p> <p>Each time you press the button, 0 → 1 → ... 8 → F will be selected in rotation.</p>	 <p>SEG14                  SEG15</p>
<p>12. Setting Cool mode</p> <p> Press Mode button to be change to Cool mode in the OFF status.</p>	



Option setting	Status
13. Setting SEG16, SEG17 option Press Low Fan button(∨) to enter SEG16 value. Press High Fan button(∧) to enter SEG17 value. Each time you press the button, 0 → 1 → ... E → F will be selected in rotation.	
14. Setting Dry mode  Press Mode button to be change to Dry mode in the OFF status.	
15. Setting SEG18, SEG20 option Press Low Fan button(∨) to enter SEG18 value. Press High Fan button(∧) to enter SEG20 value. Each time you press the button, 0 → 1 → ... E → F will be selected in rotation.	
16. Setting Fan mode  Press Mode button to be change to Fan mode in the OFF status.	
17. Setting SEG21, SEG22 option Press Low Fan button(∨) to enter SEG21 value. Press High Fan button(∧) to enter SEG22 value. Each time you press the button, 0 → 1 → ... E → F will be selected in rotation.	
18. Setting Heat mode  Press Mode button to be change to HEAT mode in the OFF status.	
19. Setting SEG23, SEG24 mode Press Low Fan button(∨) to enter SEG23 value. Press High Fan button(∧) to enter SEG24 value. Each time you press the button, 0 → 1 → ... E → F will be selected in rotation.	

### Step 3. Check the option you have set

After setting option, press  button to check whether the option code you input is correct or not.

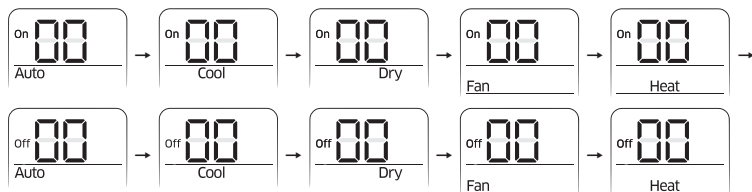

### Step 4. Input option

Press operation button  with the direction of remote control for set.

For the correct option setting, you must input the option twice.

### Step 5. Check operation

- 1) Reset the indoor unit by pressing the RESET button of indoor unit or outdoor unit.
- 2) Take the batteries out of the remote controller and insert them again and then press the operation button.

# Setting an indoor unit address and installation option

## Setting an indoor unit address (MAIN/RMC)

1. Check whether power is supplied or not.
  - When the indoor unit is not plugged in, there should be additional power supply in the indoor unit.
2. The panel(display) should be connected to an indoor unit to receive option.
3. Before installing the indoor unit, assign an address to the indoor unit according to the air conditioning system plan.
4. Assign an indoor unit address by wireless remote controller.
  - The initial setting status of indoor unit ADDRESS(MAIN/RMC) is "0A0000-100000-200000-300000".

Option No. : 0AXXXX-1XXXXX-2XXXXX-3XXXXX

Option	SEG1		SEG2		SEG3		SEG4		SEG5		SEG6	
Explanation	PAGE		MODE		Setting Main address		100-digit of indoor unit address		10-digit of indoor unit		The unit digit of an indoor unit	
Remote Controller Display												
Indication and Details	Indication	Details	Indication	Details	Indication	Details	Indication	Details	Indication	Details	Indication	Details
	0		A		0	No Main address	0~9	100-digit	0~9	10-digit	0~9	A unit digit
				1	Main address setting mode							
Option	SEG7		SEG8		SEG9		SEG10		SEG11		SEG12	
Explanation	PAGE				Setting RMC address				Group channel(*16)		Group address	
Remote Controller Display												
Indication and Details	Indication	Details	Indication	Details	Indication	Details	Indication	Details	Indication	Details	Indication	Details
	1				0	No RMC address			RMC1	0~2	RMC2	0~F
				1	RMC address setting mode							



- When "A"~"F" is entered to SEG5~6, the indoor unit MAIN ADDRESS is not changed.
- If you set the SEG 3 as 0, the indoor unit will maintain the previous MAIN ADDRESS even if you input the option value of SEG5~6.
- If you set the SEG 9 as 0, the indoor unit will maintain previous RMC ADDRESS even if you input the option value of SEG11~12.

## Setting an indoor unit installation option (suitable for the condition of each installation location)

1. Check whether power is supplied or not.
  - When the indoor unit is not plugged in, there should be additional power supply in the indoor unit.
2. The panel(display) should be connected to an indoor unit to receive option.
3. Set the installation option according to the installation condition of an air conditioner.
  - The default setting of an indoor unit installation option is "020000-100000-200010-300000"
  - Individual control of a remote controller(SEG20) is the function that controls an indoor unit individually when there is more than one indoor unit.
4. Set the indoor unit option by wireless remote controller.





### 02 series installation option

SEG1	SEG2	SEG3	SEG4	SEG5	SEG6
0	2	-	-	Central control	-
SEG7	SEG8	SEG9	SEG10	SEG11	SEG12
1	-	-	-	Opening the electronic expansion valve	-
SEG13	SEG14	SEG15	SEG16	SEG17	SEG18
2	External control	External control output	-	-	-
SEG19	SEG20	SEG21	SEG22	SEG23	SEG24
3	-	Heating setting compensation	EEV opening of an indoor unit stopped during oil return or Defrost operation.	-	-

- ▶ If you input a number other than 0~4 of the individual control of the indoor unit(SEG20), the indoor is set as "indoor 1".
- ▶ SEG5 option for centralized control usage is set to 0(disuse) as a default setting. You must adjust the setting for this option separately when centralized control needs to be used.

### 02 series installation option(Detailed)

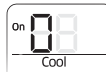
Option No. : 02XXXX-1XXXXX-2XXXXX-3XXXXX

Option	SEG1	SEG2	SEG3	SEG4	SEG5	SEG6
Explanation	PAGE	MODE	-	-	Use of central control	-
Remote Controller Display						
Indication and Details	Indication	Details	Indication	Details	Indication	Details
	0	2	0	-	0 1	0 Disuse Use

# Setting an indoor unit address and installation option

Option	SEG7	SEG8	SEG9	SEG10	SEG11	SEG12
Explanation	PAGE	-	-	-	Opening the electronic expansion valve of an indoor unit when heating operation stops.	-
Remote Controller Display						
Indication and Details	Indication	Indication	Indication	Indication	Indication	Indication
	Details	Details	Details	Details	Details	Details
	1	0	0	0	0	0
		-	-	-	-	-
					1	Default Noise reduction setting
Option	SEG13	SEG14	SEG15	SEG16	SEG17	SEG18
Explanation	PAGE	Use of external control	Setting the output of external control	-	-	-
Remote Controller Display						
Indication and Details	Indication	Indication	Indication	Indication	Indication	Indication
	Details	Details	Details	Details	Details	Details
	2	0	0	0	0	0
		Disuse	Thermo on	-	-	-
	1	ON/OFF Control	1	Operation on		
	2	OFF Control				
Option	SEG19	SEG20	SEG21	SEG22	SEG23	SEG24
Explanation	PAGE	-	Heating setting compensation	EEV opening of an indoor unit stopped during oil return or defrost operation.	-	-
Remote Controller Display						
Indication and Details	Indication	Indication	Indication	Indication	Indication	Indication
	Details	Details	Details	Details	Details	Details
	3	0	0	0	0	0
		-	Default	Default	-	-
			1	2 °C	1	Noise reduction setting
			2	5 °C		

✳ Use of external control function in SEG 14

- 1: When the contact is open, indoor unit operation is turned off, when the contact is short, the indoor unit returns to previous operation status. / When the contact is open, the indoor unit can be controlled by a remote controller.
- 2: When the contact is open, indoor unit operation is turned off, when the contact is short, indoor unit is controlled by a remote controller / When the contact is open, the indoor unit cannot be operated.

## ■ 05 series installation option

SEG1	SEG2	SEG3	SEG4	SEG5	SEG6
0	5	-	-	-	-
SEG7	SEG8	SEG9	SEG10	SEG11	SEG12
1	-	-	Compensation option for Long pipe or height difference between indoor units	-	-
SEG13	SEG14	SEG15	SEG16	SEG17	SEG18
2	-	-	-	-	-
SEG19	SEG20	SEG21	SEG22	SEG23	SEG24
3	-	-	-	-	Water tank sensor setting

## ■ 05 series installation option(Detailed)

Option No. : 05XXXX-1XXXX-2XXXX-3XXXX

Option	SEG1	SEG2	SEG3	SEG4	SEG5	SEG6
Explanation	PAGE	MODE	-	-	-	-
Remote Controller Display						
Indication and Details	Indication 0	Details 5	Indication 0	Details -	Indication 0	Details -
Option	SEG7	SEG8	SEG9	SEG10	SEG11	SEG12
Explanation	PAGE	-	-	Compensation option for Long pipe or height difference between indoor units	-	-
Remote Controller Display						
Indication and Details	Indication 1	Details -	Indication 0	Details -	Indication 0	Details -
				1) Height difference <sup>1)</sup> is more than 30m or 2) Distance <sup>2)</sup> is longer than 110m		
				1) Height difference is <sup>1)</sup> 15~30m or 2) Distance <sup>2)</sup> is 50~110m		
Option	SEG13	SEG14	SEG15	SEG16	SEG17	SEG18
Explanation	-	-	-	-	-	-
Remote Controller Display						
Indication and Details	Indication 2	Details -	Indication 0	Details -	Indication 0	Details -

# Setting an indoor unit address and installation option

Option	SEG19		SEG20		SEG21		SEG22		SEG23		SEG24	
Explanation	-		-		-		-		-		Water tank sensor setting	
Remote Controller Display												
Indication and Details	Indication	Details	Indication	Details	Indication	Details	Indication	Details	Indication	Details	Indication	Details
	3		0	-	0	-	0	-	0	-	0	Default (Direct connected water tank sensor)
											1	Shared sensing value of water tank

- 1) Height difference : The difference of the height between the corresponding indoor unit and the indoor unit installed at the lowest place.  
For example, When the indoor unit is installed 40m higher than the indoor unit installed at the lowest place, select the option "1".
- 2) Distance : The difference between the pipe length of the indoor unit installed at the farthest place from an outdoor unit and the pipe length of the corresponding indoor unit from an outdoor unit.  
For example, when the farthest pipe length is 100m and the corresponding indoor unit is 40m away from an outdoor unit, select the option "2". (100 - 40 = 60m)

## Changing a particular option

You can change each digit of set option.

Option	SEG1		SEG2		SEG3		SEG4		SEG5		SEG6	
Explanation	PAGE		MODE		The option mode you want to change		The tens' digit of an option SEG you will change		The unit digit of an option SEG you will change		The changed value	
Remote Controller Display												
Indication and Details	Indication	Details	Indication	Details	Indication	Details	Indication	Details	Indication	Details	Indication	Details
	0		D		Option mode	0~F	Tens' digit of SEG	0~9	Unit digit of SEG	0~9	The changed value	0~9



NOTE

- When changing a digit of an indoor unit address setting option, set the SEG3 as 'A'.
- When changing a digit of indoor unit installation option, set the SEG3 as '2'.

**Ex) When setting the 'buzzer control' into disuse status.**

Option	SEG1	SEG2	SEG3	SEG4	SEG5	SEG6
Explanation	PAGE	MODE	The option mode you want to change	The tens' digit of an option SEG you will change	The unit digit of an option SEG you will change	The changed value
Indication	0	D	2	1	7	1

# Product maintenance

1. Water quality management
  - Plate type heat exchanger is designed in a impossible way to disassemble part for cleaning or replace the parts. To prevent corrosion or water scale on the plate type heat exchanger, you must manage the cooling water quality in compliance with national standards.
  - If the temperature of water is higher than room temperature, make sure to keep the concentration of chloride ion below 100 ppm to prevent corrosion and the water hardness should be below 150 mCaCO<sub>3</sub>/L to prevent water scale. When scale inhibitor is used, make sure to use the ones that does not cause corrosion to stainless steel and copper.
2. Amount of water flow management
  - Insufficient amount of water flow will lead to accidents related to frozen plate type heat exchanger. Check to make sure if there is any decrease in amount of water flow due to blocked strainer, problem on air ventilation or circulation pump after checking the temperature/pressure difference between the inlet and outlet of the plate type heat exchanger. If the temperature/pressure difference exceeds optimal range, stop the operation until cause is taken care before re-start the operation.
3. Precautions on plate type heat exchanger maintenance
  - ▶ Make sure to tell the user to keep this installation manual.
    - 1) When the product was not operated for long period of time, check the followings.
      - Check the water to see if the water quality meets the standard.
      - Clean the strainer.
      - Check if the amount of water flow is appropriate. (The Flow switch starts to operate at a minimum flow rate of 12 liters per minute.)
      - Check to see if there is any problems on the water pressure, amount of water and the water temperature at inlet/outlet.
    - 2) Plate type heat exchanger is designed in a impossible way to disassemble part for cleaning. Therefore it has to be cleaned by following methods.
      - Check if there is any cleaning hole for chemical cleaning at the inlet water pipe. For water scale cleaning use diluted (down to 5 %) citric acid, oxalic acid, acetic acid, phosphoric acid. However, do not use a cleaning solution containing hydrochloric acid, sulfuric acid or nitric acid since they are highly corrosive.
      - Check if there is valve on the inlet/outlet of the plate type heat exchanger.
      - Connect a exclusive pipe for cleaning to the inlet/outlet pipe of the plate type heat exchanger and fill the detergent at the temperature of 50~60°C and circulate the detergent for about 2~5 hours. Cleaning time can be different depending on the temperature of detergent or degree of water scale. Judge the degree of water scale removal by the color of water detergent.
      - After cleaning, discharge the detergent within the plate type heat exchanger and fill the plate type heat exchanger with a water mixed with 1~2 % of sodium hydroxide (NaOH) or sodium bicarbonate (NAHCO<sub>3</sub>). Circulate the water mixture for 15~20 minutes to neutralize.
      - After neutralizing the pipes, rinse the plate type heat exchanger with distilled water.
      - If you are using the detergent sold at local retail stores, make sure that it doesn't cause any corrosion to the stainless steel.
      - For detail information on cleaning method (and proper use of detergent), contact the detergent manufacturer.
    - 3) After cleaning, check to see if it is possible to operate normally.

# Failure diagnosis

When there is problem on DVM Hydro unit / Hydro unit HT, error will be displayed on the Main PCB and the display of the remote controller.

## Display on the remote controller display when error is detected

Error indications are displayed as seen below.

### 1. Hydro unit/Hydro unit HT error

- The address of Error, "Ai" and the error code will be displayed alternately on the remote controller display.



### 2. Outdoor unit error

- The address of Error, "Ao" and error code will be displayed alternately on the remote controller display.



### 3. Wired remote controller error

- The error code will blink at 0.5 second interval on the remote controller display and the address of error will not be displayed.

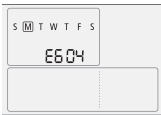



# Error code

Please follow below instruction when there is error on sensor.

- ▶ Check the resistance of the sensor
  - Hydro unit : Water pipe inlet/outlet, R-410A EVA IN/OUT → 10 kΩ @ 25 °C
  - Hydro unit HT : Water pipe inlet/outlet → 200 kΩ @25 °C, R-410A EVA IN/OUT → 10 kΩ @25 °C
- ▶ Check the DVM Hydro unit / Hydro unit HT's system diagram for the location of each sensor.
- ▶ Check if the sensor is attached properly to the copper pipe.
- ▶ If the problem persist after checking following above instruction, replace the PBA.



When error is occurred due to 'Freeze prevention', 'Pipe rupture protection' (E907, E908/E909), make sure to solve the cause before re-start the operation.

Display	Explanation
E 10 1	Communication error between DVM Hydro unit / Hydro unit HT and outdoor unit (When DVM Hydro unit / Hydro unit HT is having trouble with receiving data from outdoor unit)
E 102	Communication error on outdoor unit (When outdoor unit is having trouble sending data to DVM Hydro unit / Hydro unit HT)
E 1 10	Communication error between DVM Hydro unit / Hydro unit HT and Control Kit (Detection from the Control Kit)
E 12 1	Error on room temperature sensor of DVM Hydro unit / Hydro unit HT (Short or Open)
E 122	Error on EVA IN sensor of DVM Hydro unit / Hydro unit HT (Short or Open)
E 123	Error on EVA OUT sensor of DVM Hydro unit / Hydro unit HT (Short or Open)
E 128	EVA IN sensor of DVM Hydro unit / Hydro unit HT is detached
E 129	EVA OUT sensor of DVM Hydro unit / Hydro unit HT is detached
E 130	EVA IN and EVA OUT sensor of DVM Hydro unit / Hydro unit HT is detached
E 15 1	Error due to opened EEV of DVM Hydro unit / Hydro unit HT (2nd detection)
E 152	Error due to closed EEV of DVM Hydro unit / Hydro unit HT (2nd detection)
E 16 1	Mixed operation mode error
E 162	EEPROM error
E 163	EEPROM option setting error
E 177	Check the water circulating
E 185	Cross wiring error (When power line is connected to communication line of DVM Hydro unit / Hydro unit HT)
E 198	Error due to disconnected Thermal Fuse (When the temperature of terminal block is increases)
E60 1	Communication error between remote controller and the DVM Hydro unit / Hydro unit HT
E602	Communication error between main and sub remote controller
E604	Tracking error between remote controller and the DVM Hydro unit / Hydro unit HT
E6 18	Error due to exceeding maximum numbers of Hydro unit installation (16 units)
E627	Error due to exceeding maximum numbers of wired remote controller installation (2 units)
E633	Error caused by installing mixed models
E653	Remote controller's temperature sensor is disconnected or has problem
E654	Data error on remote controller (Memory read/write error)
E90 1	Error on the sensor of water inlet pipe (Short or Open)
E902	Error on the sensor of water outlet pipe (Short or Open)

# Error code

Display	Explanation
E904	Hot Water Tank Temperature sensor short/open
E907	Error due to pipe rupture protection (Re-operation is impossible)
E908	Error due to freeze prevention (Re-operation is possible)
E909	Error due to freeze prevention (Re-operation is impossible)
E9 10	Water temperature sensor on water outlet pipe is detached
E9 11	Flow Switch Off Error, When Water pump is running
E9 13	Six times detection for Flow Switch Error (Re-operation is possible, AM***TNBF** model only)
E9 14	Error due to incorrect thermostat connection
E9 15	Error on DC fan (Non-operating)
E9 17	Water Tank Sensor configuration error
E9 19	Error that the set temperature for disinfection operation is not reached, or, after reaching, the temperature fails to continue for the requested time

## System diagram for DVM Hydro unit / Hydro unit HT

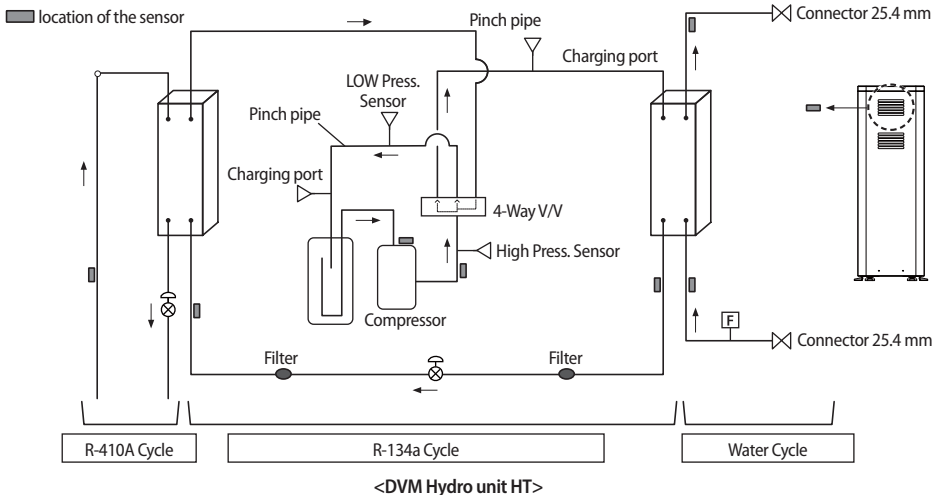
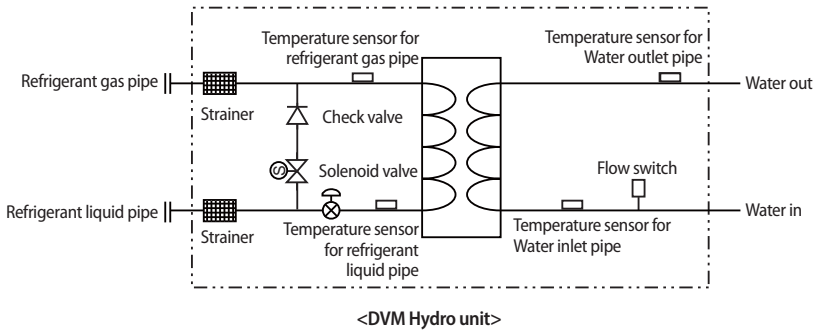

# Using the PCB Switch

## Switch is located on the control kit PCB

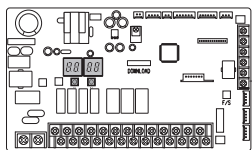

1. Check the power between DVM Hydro unit / Hydro unit HT and the distribution board.
    - Single phase: L, N
    - Three phase: R, S, T, N
  2. Check the outdoor unit.
    - 1) Check if power and communication cable of the outdoor unit is connected properly. (Communication cable between the DVM Hydro unit / Hydro unit HT and the outdoor unit should be connected to F1, F2)
    - 2) Check the connection of the temperature sensor, drain pump and display etc.
3. Press the [K1] button to check the information on status of DVM Hydro unit / Hydro unit HT as shown in the below table.

[K1] Number of press	Displayed contents	Display			
		SEG1	SEG2	SEG3	SEG4
1	Capacity of DVM Hydro unit / Hydro unit HT	1	25000W → 250		
2	Set temperature	2	27 °C → 027		
3	Current temperature	3	27 °C → 027		
4	Room temperature	4	27 °C → 027		
5	EVA IN temperature	5	-17 °C → -17		
6	EVA OUT temperature	6	-17 °C → -17		
7	WATER IN temperature	7	-17 °C → -17		
8	WATER OUT temperature	8	-17 °C → -17		
9	Hot water tank temperature	9	27 °C → 027		
10	Defrost bypass valve	A	ON → 000 / OFF → 001		
11	Pump output	B	ON → 000 / OFF → 001		
12	Flow switch input	C	ON → 000 / OFF → 001		
13	EEV Step	D	1400 → 140		
14	Current targeted degree of super heat	E	3 °C → 003		
15	DVM Hydro unit / Hydro unit HT address	F	01 → 001		
16	Version	June 2020 → 2006			

4. When there are more than one error, press the [K2] button to check the errors.

[K2] Number of press	Displayed contents
1	Currently displayed error
2	Most recently occurred error 1
3	Most recently occurred error 2
4	Most recently occurred error 3
5	Most recently occurred error 4

# Using the PCB Switch

Switch is located on the Main PCB (AM\*\*\*FNB\*\*\* Series)

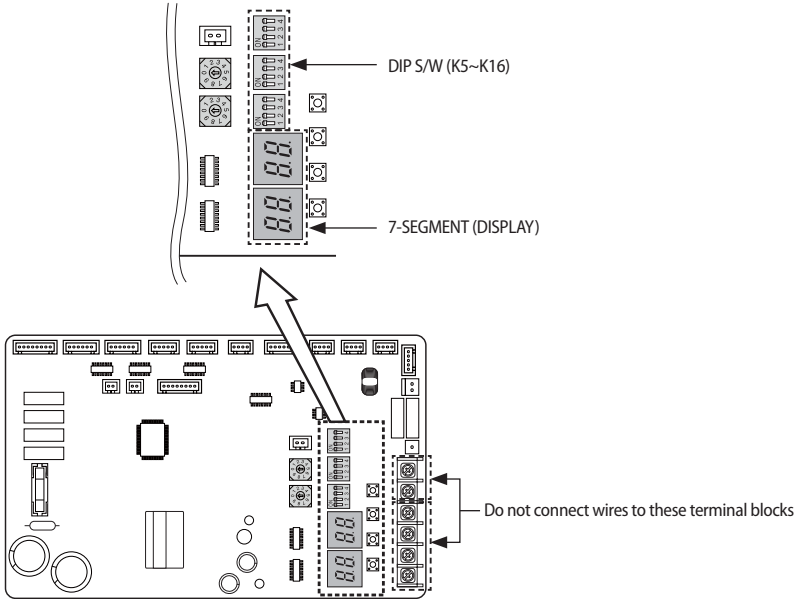

## S/W function

Tact switch	Heating KEY operation	-	Reset	View Mode
	K1	K2	K3	K4
DIP switch	-	-	-	-
	K5	K6	K7	K8
	-	-	Heating capacity correction	Heating capacity correction
	K9	K10	K11	K12
	-	-	-	-
	K13	K14	K15	K16

## TACT S/W specification setting

TACT switch	Number of presses	Content	SEG1	SEG2	SEG3	SEG4	Remark
K1	1	Heating refrigerant charging	8	8			
	2	Completion					
K3		Reset					

► K4 input display order

(1) Current frequency → (2) Low pressure value → (3) Outdoor temperature → (4) Discharge temperature → (5) OLP temperature → (6) COND temperature → (7) Suction temperature → (8) High pressure value → (9) → (10) → (11) MAIN EEV → (12) Present running current → (13) Number of connected hydro units → (14) Number of operating hydro units → (15) Sum of hydro unit capacity

K4(Press and hold to enter the setting) → K4 press(Number of press)	Displayed content	Display on segment		
0 time	Main Micom version	Version (ex. 0912)		
1 time	Inverter Micom version	Version (ex. 0912)		
2 times	EEPROM version	Version (ex. 0912)		
3 times	Automatically assigned address of the units	SEG1	SEG2	SEG3, 4
		Hydro unit:"A"	Hydro unit:"0"	Address (ex: 05)
4 times	Manually assigned address of the units	SEG1	SEG2	SEG3, 4
		Hydro unit:"A"	Hydro unit:"0"	Address (ex: 01)

[K4] Number of press	Displayed contents	Display			
		SEG1	SEG2	SEG3	SEG4
1	Current frequency	1	15Hz → 015		
2	Low pressure value	2	1.56 MPa → 156		
3	Outdoor temperature	3	23.5 °C → 235		
4	Discharge temperature	4	80.7°C → 807		
5	OLP temperature	5	95 °C → 950		
6	COND temperature	6	26.3 °C → 263		
7	Suction temperature	7	26.7 °C → 267		
8	High pressure value	8	1.56 MPa → 156		
9		9			
10		A			
11	MAIN EEV	B	1500Step → 150		
12	Present running current	C	15A → 150		
13	Number of connected hydro units	D	10 → 010		
14	Number of operating hydro units	E	10 → 010		
15	Sum of hydro unit capacity	F	12000kcal/h → 120		

► K11, K12: Changing heating capacity correction table

Switch		Function
K11	K12	
ON	ON	Default
ON	OFF	Default -196 kPa
OFF	ON	Default - 98 kPa
OFF	OFF	Default + 98 kPa

- \* Heating operation increases frequency when current high pressure is higher than target high pressure; vice versa, decreases frequency. When target high pressure is high, the discharge water temperature of a hydro unit will increase but energy consumption will increase as well.
- \* Maintaining factory default status is recommended. However, if you want to reduce energy consumption or you are not satisfied with heating performance, control the operation according to the surrounding environment. As you decrease the target high pressure, energy consumption and noise may decrease but hydro unit water discharge temperature decreases as well.

# Using the PCB Switch

Switch is located on the Main PCB (AM\*\*\*TNBF\*\* Series)

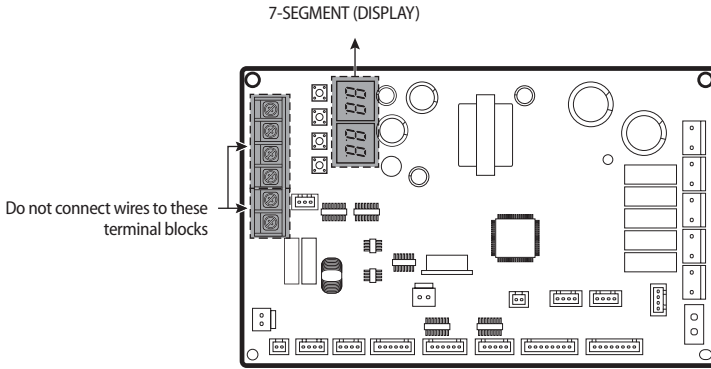

## Tact S/W Function

Tact switch	Number of press	Content	SEG1	SEG2	SEG3	SEG4
K1	1	Heating refrigerant charging	8	8		
	2	Vacuuming	8	2		
	3	End Key operation	-	-		
K2	1	Inverter Check	8	3		
	2	Discharge mode of DC link voltage	8	4		
	3	End Key operation	-	-		
K3	1	Reset	-	-		

## Setting key function (AM\*\*\*TNBF\*\* Model only)

- Press and hold K2 to enter the option setting. (Only available when the operation is stopped)
  - If you enter the option setting, display will show the following. (If you have set the 'Emergency operation for compressor malfunction', 1 or 2 will be displayed on Seg 4.)



- Seg 1 and Seg 2 will display the number for selected option.
  - Seg 3 and Seg 4 will display the number for set value of the selected option.
- If you have entered option setting, you can shortly press the K1 switch to adjust the value of the Seg 1, Seg 2 and select the desired option.

Example)



- If you have selected desired option, you can shortly press the K2 switch to adjust the value of the Seg 3, Seg 4 and change the function for the selected option.

Example)



- After selecting the function for options, press and hold the K2 switch for 2 seconds. Edited value of the option will be saved when entire segments blinks and tracking mode begins.



• Edited option will not be saved if you do not end the option setting as explained in above instruction.

- \* While you are setting the option, you may press and hold the K1 button to reset the value to previous setting.
- \* If you want to restore the setting to factory default, press and hold the K4 button while you are in the option setting mode.
  - If you press and hold the K4 button, setting will be restored to factory default but it doesn't mean that restored setting is saved. Press and hold the K2 button. When the segments shows that tracking mode is in progress, setting will be saved.

Operation item	SEG1	SEG2	SEG3	SEG4	Function of the option	Remarks
Capacity correction for heating	0	0	0	0	Default	Targeted high pressure [Mpa]
			0	1	Default - 0.2	
			0	2	Default - 0.1	
			0	3	Default + 0.1	
Changing current limit value	0	1	0	0	Default	A: 1phase (2A), 3phase (1A) B: 1phase (4A), 3phase (2A) C: 1phase (6A), 3phase (3A)
			0	1	Default-A	
			0	2	Default-B	
			0	3	Default-C	
Stabilization mode of water outlet temperature	0	2	0	0	Disabled (Factory default)	Compressor Hz control to continuously maintain the set water outlet temperature
			0	1	Enabled	

# Completing the installation

---

- ▶ Measure the power terminal (1 phase : L, N) and the grounding of the outdoor unit using a DC 500 V insulation resistance meter before connecting the power.

The measured value should be over 30 MΩ



- Never measure the communication terminal to prevent the communication circuit from being damaged.
- Check the short-circuit of the communication terminal using a general circuit tester.
- When you execute Key operation (trial operation, pump down etc.) from the outdoor unit, select 'Water temperature' as a control type for DVM Hydro unit / Hydro unit HT. (This can be set from the service mode for wired remote controller)

# Explaining functions to the user

---

When the DVM Hydro unit / Hydro unit HT is completed explain the following functions to the user by referring to the user manual.

1. Starting/Stopping the operation of DVM Hydro unit / Hydro unit HT.
2. Adjusting the temperature when selecting the operation mode.
3. Setting the 'On/Off timer'
4. Cleaning the DVM Hydro unit / Hydro unit HT.
  - To prevent performance decrease or product failure, strainer on the DVM Hydro unit / Hydro unit HT must be cleaned regularly (at least once a year). Explain these matters to the user and how to clean the strainer.
5. When user moves out for long time, user should drain water circuit of the product, or do not cut off the power supply if the outside temperature is under the 0 °C



- Hand over the user manual to the user after explaining the functions of the DVM Hydro unit / Hydro unit HT and make sure to tell them to keep the manual.



# Appendix

## Model specification (weight and dimension)

Type	Model	Net weight	Net dimension (W x D x H)
DVM Hydro unit	AM160FNBDEH/EU	29.0 kg	518 x 330 x 627 mm
	AM320FNBDEH/EU	33.0 kg	518 x 330 x 627 mm
	AM500FNBDEH/EU	40.0 kg	518 x 330 x 627 mm
Hydro unit HT	AM160FNBFEB/EU	104 kg	518 x 330 x 1,210 mm
	AM160FNBFGB/EU	104 kg	518 x 330 x 1,210 mm
	AM250FNBFEB/EU	104 kg	518 x 330 x 1,210 mm
	AM250FNBFGB/EU	104 kg	518 x 330 x 1,210 mm
	AM160TNBFEB/EU	105.0 kg	518 x 330 x 1,210 mm
	AM160TNBFGB/EU	103.5 kg	518 x 330 x 1,210 mm
	AM250TNBFEB/EU	105.0 kg	518 x 330 x 1,210 mm
	AM250TNBFGB/EU	103.5 kg	518 x 330 x 1,210 mm

# SAMSUNG

Samsung, PO Box 12987, Blackrock, Co. Dublin. IE  
or Euro QA Lab. Saxony Way, Yateley, Hampshire GU46 6GG, UK

This product is India RoHS compliant

