

AIR CONDITIONING SYSTEMS

# CITY MULTI



## DATA BOOK

MODEL

---

**PEFY-M-VMA(L)-A**



**PEFY-M-VMA(L)-A**

1. SPECIFICATIONS .....	2
2. EXTERNAL DIMENSIONS .....	8
3. CENTER OF GRAVITY .....	16
4. ELECTRICAL WIRING DIAGRAMS .....	17
5. SOUND LEVELS .....	18
5-1. Sound levels .....	18
5-2. NC curves .....	19
6. FAN CHARACTERISTICS CURVES .....	23
7. CAPACITY TABLES .....	32
7-1. Correction by fan speed .....	32
8. ELECTRICAL CHARACTERISTICS .....	33
9. OPTIONAL PARTS .....	34
9-1. Optional parts line up for the Indoor unit .....	34
9-2. Filter box .....	34

# 1. SPECIFICATIONS

Ceiling concealed (Medium static pressure type)

PEFY-M-VMA(L)-A

Model		PEFY-M20VMA-A	PEFY-M25VMA-A	PEFY-M32VMA-A	PEFY-M40VMA-A		
Power source		1-phase 220-230-240 V 50 Hz	1-phase 220-230-240 V 50 Hz	1-phase 220-230-240 V 50 Hz	1-phase 220-230-240 V 50 Hz		
Cooling capacity (Nominal)	*1 kW	2.2	2.8	3.6	4.5		
	*1 kcal/h	1,900	2,400	3,100	3,900		
	*1 BTU/h	7,500	9,600	12,300	15,400		
	*2 Power input kW	0.032	0.032	0.044	0.047		
	*2 Current input A	0.26-0.25-0.24	0.26-0.25-0.24	0.36-0.34-0.33	0.39-0.37-0.36		
Heating capacity (Nominal)	*3 kW	2.5	3.2	4.0	5.0		
	*3 kcal/h	2,200	2,800	3,400	4,300		
	*3 BTU/h	8,500	10,900	13,600	17,100		
	*2 Power input kW	0.030	0.030	0.042	0.045		
	*2 Current input A	0.26-0.25-0.24	0.26-0.25-0.24	0.36-0.34-0.33	0.39-0.37-0.36		
External finish		Galvanized steel plate	Galvanized steel plate	Galvanized steel plate	Galvanized steel plate		
External dimension H x W x D		mm	250 x 700 x 732	250 x 700 x 732	250 x 900 x 732		
		in.	9-7/8 x 27-9/16 x 28-7/8	9-7/8 x 27-9/16 x 28-7/8	9-7/8 x 27-9/16 x 28-7/8	9-7/8 x 35-7/16 x 28-7/8	
Net weight		kg (lbs)	21 (47)	21 (47)	25 (56)		
Heat exchanger		Cross fin (Aluminum fin and copper tube)	Cross fin (Aluminum fin and copper tube)	Cross fin (Aluminum fin and copper tube)	Cross fin (Aluminum fin and copper tube)		
FAN	Type x Quantity		Sirocco fan x 1	Sirocco fan x 1	Sirocco fan x 1	Sirocco fan x 2	
	*4 External static press.	Pa	35 - <50> - <70> - <100> - <150>	35 - <50> - <70> - <100> - <150>	35 - <50> - <70> - <100> - <150>	35 - <50> - <70> - <100> - <150>	
		mmH <sub>2</sub> O	3.6 - <5.1> - <7.1> - <10.2> - <15.3>	3.6 - <5.1> - <7.1> - <10.2> - <15.3>	3.6 - <5.1> - <7.1> - <10.2> - <15.3>	3.6 - <5.1> - <7.1> - <10.2> - <15.3>	
	Motor Type		DC motor	DC motor	DC motor	DC motor	
	Motor output kW		0.085	0.085	0.085	0.121	
	Driving mechanism		Direct-driven by motor	Direct-driven by motor	Direct-driven by motor	Direct-driven by motor	
	Air flow rate		(Low-Mid-High)				
			m <sup>3</sup> /min	6.0 - 7.5 - 8.5	6.0 - 7.5 - 8.5	7.5 - 9.0 - 10.5	10.0 - 12.0 - 14.0
			L/s	100 - 125 - 142	100 - 125 - 142	125 - 150 - 175	167 - 200 - 233
			cfm	212 - 265 - 300	212 - 265 - 300	265 - 318 - 371	353 - 424 - 494
Sound pressure level (measured in anechoic room)		(Low-Mid-High)					
*2, 5 *2, 6	dB <A>	21.0-25.0-27.0	21.0-25.0-27.0	23.0-27.0-30.0	23.0-28.0-31.0		
		18.0-22.0-24.0	18.0-22.0-24.0	20.0-24.0-27.0	20.0-25.0-28.0		
Insulation material		EPS, Polystyrene foam, Urethane foam	EPS, Polystyrene foam, Urethane foam	EPS, Polystyrene foam, Urethane foam	EPS, Polystyrene foam, Urethane foam		
Air filter		PP honeycomb fabric.	PP honeycomb fabric.	PP honeycomb fabric.	PP honeycomb fabric.		
Protection device		Fuse	Fuse	Fuse	Fuse		
Refrigerant control device		LEV	LEV	LEV	LEV		
Connectable outdoor unit		R32, R410A CITY MULTI	R32, R410A CITY MULTI	R32, R410A CITY MULTI	R32, R410A CITY MULTI		
Refrigerant piping diameter	Liquid	mm (in.) 6.35 (1/4)Braze	6.35 (1/4)Braze	6.35 (1/4)Braze	6.35 (1/4)Braze		
	Gas	mm (in.) 12.7 (1/2)Braze	12.7 (1/2)Braze	12.7 (1/2)Braze	12.7 (1/2)Braze		
Field drain pipe size		mm (in.) O.D.32 (1-1/4")	O.D.32 (1-1/4")	O.D.32 (1-1/4")	O.D.32 (1-1/4")		
Drawing	External	KB94C15Y	KB94C15Y	KB94C15Y	KB94C15Y		
	Wiring	KB94C15X	KB94C15X	KB94C15X	KB94C15X		
	Refrigerant cycle	-	-	-	-		
Standard attachment	Document	Installation Manual, Instruction Book	Installation Manual, Instruction Book	Installation Manual, Instruction Book	Installation Manual, Instruction Book		
	Accessory	Washer, Drain hose, Tie band	Washer, Drain hose, Tie band	Washer, Drain hose, Tie band	Washer, Drain hose, Tie band		
Optional parts	Filter box	PAC-KE91TB-E	PAC-KE91TB-E	PAC-KE91TB-E	PAC-KE92TB-E		
Remarks		* Details on foundation work, duct work, insulation work, electrical wiring, power source switch, and other items shall be referred to the Installation Manual. * Due to continuing improvement, above specifications may be subject to change without notice.					

Notes:	Unit converter
1. Nominal cooling conditions Indoor: 27°CDB/19°CWB (81°FDB/66°FWB), Outdoor: 35°CDB (95°FDB) Pipe length: 7.5m (24-9/16ft.), Level difference: 0m (0ft.)	kcal = kW x 860
2. The values are measured at the factory setting of external static pressure.	BTU/h = kW x 3,412
3. Nominal heating conditions Indoor: 20°CDB (68°FDB), Outdoor: 7°CDB/6°CWB (45°FDB/43°FWB) Pipe length: 7.5m (24-9/16ft.), Level difference: 0m (0ft.)	cfm = m <sup>3</sup> /min x 35.31
4. The factory setting of airflow mode and external static pressure mode is shown without < >. Refer to "Fan characteristics curves", according to the external static pressure, in DATA BOOK for the usable range of air flow rate.	lbs = kg/0.4536
5. Measured in anechoic room with a 1 m air inlet duct and 2 m air outlet duct attached to the unit and 1.5 m below the unit.	*Above specification data is subject to rounding variation.
6. Measured in anechoic room with a 2 m air inlet duct and 2 m air outlet duct attached to the unit and 1.5 m below the unit.	
* The sound pressure level measured by the conventional method in JIS.	
* R32 is flammable, and certain restrictions apply to the installation of units. For detail, refer to the section in the Databook on installation restrictions.	

# 1. SPECIFICATIONS

Ceiling concealed (Medium static pressure type)

Model		PEFY-M50VMA-A	PEFY-M63VMA-A	PEFY-M71VMA-A	PEFY-M80VMA-A			
Power source		1-phase 220-230-240 V 50 Hz	1-phase 220-230-240 V 50 Hz	1-phase 220-230-240 V 50 Hz	1-phase 220-230-240 V 50 Hz			
Cooling capacity (Nominal)	*1	kW	5.6	7.1	8.0	9.0		
	*1	kcal/h	4,800	6,100	6,900	7,700		
	*1	BTU/h	19,100	24,200	27,300	30,700		
	*2	Power input	kW	0.066	0.087	0.080	0.080	
	*2	Current input	A	0.53-0.51-0.49	0.69-0.66-0.63	0.60-0.57-0.55	0.60-0.57-0.55	
	Heating capacity (Nominal)		*3	kW	6.3	8.0	9.0	10.0
		*3	kcal/h	5,400	6,900	7,700	8,600	
		*3	BTU/h	21,500	27,300	30,700	34,100	
		*2	Power input	kW	0.064	0.085	0.078	0.078
		*2	Current input	A	0.53-0.51-0.49	0.69-0.66-0.63	0.60-0.57-0.55	0.60-0.57-0.55
External finish		Galvanized steel plate						
External dimension H x W x D		mm	250 x 900 x 732	250 x 900 x 732	250 x 1,100 x 732	250 x 1,100 x 732		
		in.	9-7/8 x 35-7/16 x 28-7/8	9-7/8 x 35-7/16 x 28-7/8	9-7/8 x 43-5/16 x 28-7/8	9-7/8 x 43-5/16 x 28-7/8		
Net weight		kg (lbs)	25 (56)	27 (60)	30 (67)	30 (67)		
Heat exchanger		Cross fin (Aluminum fin and copper tube)						
FAN		Sirocco fan x 2						
*4	Type x Quantity		Sirocco fan x 2					
	External static press.	Pa	35 - <50> - <70> - <100> - <150>	35 - <50> - <70> - <100> - <150>	40 - <50> - <70> - <100> - <150>	40 - <50> - <70> - <100> - <150>		
		mmH <sub>2</sub> O	3.6 - <5.1> - <7.1> - <10.2> - <15.3>	3.6 - <5.1> - <7.1> - <10.2> - <15.3>	4.1 - <5.1> - <7.1> - <10.2> - <15.3>	4.1 - <5.1> - <7.1> - <10.2> - <15.3>		
	Motor Type		DC motor					
	Motor output		kW					
	Driving mechanism		Direct-driven by motor					
	Air flow rate		(Low-Mid-High)					
			m <sup>3</sup> /min	12.0 - 14.5 - 17.0	13.5 - 16.0 - 19.0	14.5 - 18.0 - 21.0	14.5 - 18.0 - 21.0	
			L/s	200 - 242 - 283	225 - 267 - 317	242 - 300 - 350	242 - 300 - 350	
			cfm	424 - 512 - 600	477 - 565 - 671	512 - 636 - 742	512 - 636 - 742	
Sound pressure level (measured in anechoic room)		(Low-Mid-High)						
		*2, 5	24.0-31.0-34.0	27.0-31.0-35.0	25.0-31.0-34.0	25.0-31.0-34.0		
		*2, 6	21.0-28.0-31.0	24.0-28.0-32.0	22.0-28.0-31.0	22.0-28.0-31.0		
Insulation material		EPS, Polystyrene foam, Urethane foam						
Air filter		PP honeycomb fabric.						
Protection device		Fuse						
Refrigerant control device		LEV						
Connectable outdoor unit		R32, R410A CITY MULTI						
Refrigerant piping diameter	Liquid	mm (in.)	6.35 (1/4)Braze	9.52 (3/8)Braze	9.52 (3/8)Braze	9.52 (3/8)Braze		
	Gas	mm (in.)	12.7 (1/2)Braze	15.88 (5/8)Braze	15.88 (5/8)Braze	15.88 (5/8)Braze		
Field drain pipe size		mm (in.)	O.D.32 (1-1/4")	O.D.32 (1-1/4")	O.D.32 (1-1/4")	O.D.32 (1-1/4")		
Drawing	External		KB94C15Y					
	Wiring		KB94C15X					
	Refrigerant cycle		-					
Standard attachment	Document		Installation Manual, Instruction Book					
	Accessory		Washer, Drain hose, Tie band					
Optional parts	Filter box		PAC-KE92TB-E					
Remarks		* Details on foundation work, duct work, insulation work, electrical wiring, power source switch, and other items shall be referred to the Installation Manual. * Due to continuing improvement, above specifications may be subject to change without notice.						

Notes:	Unit converter
1. Nominal cooling conditions Indoor:27°CDB/19°CWB (81°FDB/66°FWB), Outdoor:35°CDB (95°FDB) Pipe length:7.5m (24-9/16ft.), Level difference:0m (0ft.)	kcal =kW x 860
2. The values are measured at the factory setting of external static pressure.	BTU/h =kW x 3,412
3. Nominal heating conditions Indoor:20°CDB (68°FDB), Outdoor:7°CDB/6°CWB (45°FDB/43°FWB) Pipe length:7.5m (24-9/16ft.), Level difference:0m (0ft.)	cfm =m <sup>3</sup> /min x 35.31
4. The factory setting of airflow mode and external static pressure mode is shown without < > . Refer to "Fan characteristics curves", according to the external static pressure, in DATA BOOK for the usable range of air flow rate.	lbs =kg/0.4536
5. Measured in anechoic room with a 1 m air inlet duct and 2 m air outlet duct attached to the unit and 1.5 m below the unit.	*Above specification data is
6. Measured in anechoic room with a 2 m air inlet duct and 2 m air outlet duct attached to the unit and 1.5 m below the unit.	subject to rounding variation.
* The sound pressure level measured by the conventional method in JIS.	
* R32 is flammable, and certain restrictions apply to the installation of units. For detail, refer to the section in the Databook on installation restrictions.	

# 1. SPECIFICATIONS

Ceiling concealed (Medium static pressure type)

PEFY-M-VMA(L)-A

Model		PEFY-M100VMA-A	PEFY-M125VMA-A	PEFY-M140VMA-A	
Power source		1-phase 220-230-240 V 50 Hz	1-phase 220-230-240 V 50 Hz	1-phase 220-230-240 V 50 Hz	
Cooling capacity (Nominal)	*1 kW	11.2	14.0	16.0	
	*1 kcal/h	9,600	12,000	13,800	
	*1 BTU/h	38,200	47,800	54,600	
	*2 Power input kW	0.142	0.199	0.208	
	*2 Current input A	1.01-0.97-0.93	1.29-1.23-1.18	1.40-1.34-1.28	
	Heating capacity (Nominal)				
	*3 kW	12.5	16.0	18.0	
	*3 kcal/h	10,800	13,800	15,500	
	*3 BTU/h	42,700	54,600	61,400	
	*2 Power input kW	0.140	0.197	0.206	
	*2 Current input A	1.01-0.97-0.93	1.29-1.23-1.18	1.40-1.34-1.28	
	External finish		Galvanized steel plate	Galvanized steel plate	Galvanized steel plate
External dimension H x W x D		mm	250 x 1,400 x 732	250 x 1,600 x 732	
		in.	9-7/8 x 55-1/8 x 28-7/8	9-7/8 x 55-1/8 x 28-7/8	
Net weight		kg (lbs)	37 (82)	38 (84)	
Heat exchanger		Cross fin (Aluminum fin and copper tube)	Cross fin (Aluminum fin and copper tube)	Cross fin (Aluminum fin and copper tube)	
FAN		Sirocco fan x 3			
*4	Type x Quantity		Sirocco fan x 3		
	External static press.		Pa	40 - <50> - <70> - <100> - <150>	
			mmH <sub>2</sub> O	4.1 - <5.1> - <7.1> - <10.2> - <15.3>	
	Motor Type		DC motor		
	Motor output kW		0.300		
	Driving mechanism		Direct-driven by motor		
	Air flow rate		(Low-Mid-High)		
			m <sup>3</sup> /min	23.0 - 28.0 - 32.0	
			L/s	383 - 467 - 533	
			cfm	812 - 989 - 1,130	
Sound pressure level (measured in anechoic room)		(Low-Mid-High)			
*2, 5 *2, 6		dB <A>	30.0-35.0-38.0		
			27.0-32.0-35.0		
Insulation material		EPS, Polystyrene foam, Urethane foam			
Air filter		PP honeycomb fabric.			
Protection device		Fuse			
Refrigerant control device		LEV			
Connectable outdoor unit		R32, R410A CITY MULTI			
Refrigerant piping diameter	Liquid	9.52 (3/8)Braze			
	Gas	15.88 (5/8)Braze			
Field drain pipe size		mm (in.) O.D.32 (1-1/4")			
Drawing	External		KB94C15Y		
	Wiring		KB94C15X		
	Refrigerant cycle		-		
Standard attachment	Document		Installation Manual, Instruction Book		
	Accessory		Washer, Drain hose, Tie band		
Optional parts	Filter box	PAC-KE94TB-E			
Remarks		* Details on foundation work, duct work, insulation work, electrical wiring, power source switch, and other items shall be referred to the Installation Manual. * Due to continuing improvement, above specifications may be subject to change without notice.			

Notes:	Unit converter
1.Nominal cooling conditions Indoor:27°CDB/19°CWB (81°FDB/66°FWB), Outdoor:35°CDB (95°FDB) Pipe length:7.5m (24-9/16ft.), Level difference:0m (0ft.)	kcal =kW x 860
2.The values are measured at the factory setting of external static pressure.	BTU/h =kW x 3,412
3.Nominal heating conditions Indoor:20°CDB (68°FDB), Outdoor:7°CDB/6°CWB (45°FDB/43°FWB) Pipe length:7.5m (24-9/16ft.), Level difference:0m (0ft.)	cfm =m <sup>3</sup> /min x 35.31
4.The factory setting of airflow mode and external static pressure mode is shown without < > . Refer to "Fan characteristics curves", according to the external static pressure, in DATA BOOK for the usable range of air flow rate.	lbs =kg/0.4536
5.Measured in anechoic room with a 1 m air inlet duct and 2 m air outlet duct attached to the unit and 1.5 m below the unit.	*Above specification data is subject to rounding variation.
6.Measured in anechoic room with a 2 m air inlet duct and 2 m air outlet duct attached to the unit and 1.5 m below the unit.	
* The sound pressure level measured by the conventional method in JIS.	
* R32 is flammable, and certain restrictions apply to the installation of units. For detail, refer to the section in the Databook on installation restrictions.	

# 1. SPECIFICATIONS

Ceiling concealed (Medium static pressure type)

Model		PEFY-M20VMAL-A	PEFY-M25VMAL-A	PEFY-M32VMAL-A	PEFY-M40VMAL-A	
Power source		1-phase 220-230-240 V 50 Hz	1-phase 220-230-240 V 50 Hz	1-phase 220-230-240 V 50 Hz	1-phase 220-230-240 V 50 Hz	
Cooling capacity (Nominal)	*1	kW	2.2	2.8	3.6	
	*1	kcal/h	1,900	2,400	3,100	
	*1	BTU/h	7,500	9,600	12,300	
	*2	Power input	kW	0.030	0.042	0.045
	*2	Current input	A	0.26-0.25-0.24	0.26-0.25-0.24	0.36-0.34-0.33
						0.39-0.37-0.36
Heating capacity (Nominal)	*3	kW	2.5	3.2	4.0	
	*3	kcal/h	2,200	2,800	3,400	
	*3	BTU/h	8,500	10,900	13,600	
	*2	Power input	kW	0.030	0.042	0.045
	*2	Current input	A	0.26-0.25-0.24	0.26-0.25-0.24	0.36-0.34-0.33
						0.39-0.37-0.36
External finish		Galvanized steel plate	Galvanized steel plate	Galvanized steel plate	Galvanized steel plate	
External dimension H x W x D		mm	250 x 700 x 732	250 x 700 x 732	250 x 700 x 732	
		in.	9-7/8 x 27-9/16 x 28-7/8	9-7/8 x 27-9/16 x 28-7/8	9-7/8 x 27-9/16 x 28-7/8	9-7/8 x 35-7/16 x 28-7/8
Net weight		kg (lbs)	20 (45)	20 (45)	20 (45)	
Heat exchanger		Cross fin (Aluminum fin and copper tube)	Cross fin (Aluminum fin and copper tube)	Cross fin (Aluminum fin and copper tube)	Cross fin (Aluminum fin and copper tube)	
FAN	Type x Quantity		Sirocco fan x 1	Sirocco fan x 1	Sirocco fan x 1	
	*4	External static press.	Pa	35 - <50> - <70> - <100> - <150>	35 - <50> - <70> - <100> - <150>	35 - <50> - <70> - <100> - <150>
			mmH <sub>2</sub> O	3.6 - <5.1> - <7.1> - <10.2> - <15.3>	3.6 - <5.1> - <7.1> - <10.2> - <15.3>	3.6 - <5.1> - <7.1> - <10.2> - <15.3>
	Motor Type		DC motor	DC motor	DC motor	DC motor
	Motor output		kW	0.085	0.085	0.085
	Driving mechanism		Direct-driven by motor	Direct-driven by motor	Direct-driven by motor	Direct-driven by motor
	Air flow rate		(Low-Mid-High)		(Low-Mid-High)	(Low-Mid-High)
			m <sup>3</sup> /min	6.0 - 7.5 - 8.5	6.0 - 7.5 - 8.5	7.5 - 9.0 - 10.5
			L/s	100 - 125 - 142	100 - 125 - 142	125 - 150 - 175
			cfm	212 - 265 - 300	212 - 265 - 300	265 - 318 - 371
Sound pressure level (measured in anechoic room)		(Low-Mid-High)	(Low-Mid-High)	(Low-Mid-High)	(Low-Mid-High)	
*2, 5	*2, 6	dB <A>	21.0-25.0-27.0	21.0-25.0-27.0	23.0-27.0-30.0	
			18.0-22.0-24.0	18.0-22.0-24.0	20.0-24.0-27.0	
Insulation material		EPS, Polystyrene foam, Urethane foam	EPS, Polystyrene foam, Urethane foam	EPS, Polystyrene foam, Urethane foam	EPS, Polystyrene foam, Urethane foam	
Air filter		PP honeycomb fabric.	PP honeycomb fabric.	PP honeycomb fabric.	PP honeycomb fabric.	
Protection device		Fuse	Fuse	Fuse	Fuse	
Refrigerant control device		LEV	LEV	LEV	LEV	
Connectable outdoor unit		R32, R410A CITY MULTI	R32, R410A CITY MULTI	R32, R410A CITY MULTI	R32, R410A CITY MULTI	
Refrigerant piping diameter	Liquid	mm (in.)	6.35 (1/4)Braze	6.35 (1/4)Braze	6.35 (1/4)Braze	
	Gas	mm (in.)	12.7 (1/2)Braze	12.7 (1/2)Braze	12.7 (1/2)Braze	
Field drain pipe size		mm (in.)	O.D.32 (1-1/4")	O.D.32 (1-1/4")	O.D.32 (1-1/4")	
Drawing	External		KB94C15Z	KB94C15Z	KB94C15Z	
	Wiring		KB94C15X	KB94C15X	KB94C15X	
	Refrigerant cycle		-	-	-	
Standard attachment	Document		Installation Manual, Instruction Book	Installation Manual, Instruction Book	Installation Manual, Instruction Book	
	Accessory		Washer, Drain hose, Tie band	Washer, Drain hose, Tie band	Washer, Drain hose, Tie band	
Optional parts	Filter box		PAC-KE91TB-E	PAC-KE91TB-E	PAC-KE91TB-E	
Remarks		* Details on foundation work, duct work, insulation work, electrical wiring, power source switch, and other items shall be referred to the Installation Manual. * Due to continuing improvement, above specifications may be subject to change without notice.				

Notes:	Unit converter
1. Nominal cooling conditions Indoor:27°CDB/19°CWB (81°FDB/66°FWB), Outdoor:35°CDB (95°FDB) Pipe length:7.5m (24-9/16ft.), Level difference:0m (0ft.)	kcal =kW x 860
2. The values are measured at the factory setting of external static pressure.	BTU/h =kW x 3,412
3. Nominal heating conditions Indoor:20°CDB (68°FDB), Outdoor:7°CDB/6°CWB (45°FDB/43°FWB) Pipe length:7.5m (24-9/16ft.), Level difference:0m (0ft.)	cfm =m <sup>3</sup> /min x 35.31
4. The factory setting of airflow mode and external static pressure mode is shown without < > . Refer to "Fan characteristics curves", according to the external static pressure, in DATA BOOK for the usable range of air flow rate.	lbs =kg/0.4536
5. Measured in anechoic room with a 1 m air inlet duct and 2 m air outlet duct attached to the unit and 1.5 m below the unit.	*Above specification data is
6. Measured in anechoic room with a 2 m air inlet duct and 2 m air outlet duct attached to the unit and 1.5 m below the unit.	subject to rounding variation.
* The sound pressure level measured by the conventional method in JIS.	
* R32 is flammable, and certain restrictions apply to the installation of units. For detail, refer to the section in the Databook on installation restrictions.	

# 1. SPECIFICATIONS

Ceiling concealed (Medium static pressure type)

PEFY-M-VMA(L)-A

Model		PEFY-M50VMA-A	PEFY-M63VMA-A	PEFY-M71VMA-A	PEFY-M80VMA-A		
Power source		1-phase 220-230-240 V 50 Hz	1-phase 220-230-240 V 50 Hz	1-phase 220-230-240 V 50 Hz	1-phase 220-230-240 V 50 Hz		
Cooling capacity (Nominal)	*1 kW	5.6	7.1	8.0	9.0		
	*1 kcal/h	4,800	6,100	6,900	7,700		
	*1 BTU/h	19,100	24,200	27,300	30,700		
	*2 Power input kW	0.064	0.085	0.078	0.078		
	*2 Current input A	0.53-0.51-0.49	0.69-0.66-0.63	0.60-0.57-0.55	0.60-0.57-0.55		
Heating capacity (Nominal)	*3 kW	6.3	8.0	9.0	10.0		
	*3 kcal/h	5,400	6,900	7,700	8,600		
	*3 BTU/h	21,500	27,300	30,700	34,100		
	*2 Power input kW	0.064	0.085	0.078	0.078		
	*2 Current input A	0.53-0.51-0.49	0.69-0.66-0.63	0.60-0.57-0.55	0.60-0.57-0.55		
External finish		Galvanized steel plate	Galvanized steel plate	Galvanized steel plate	Galvanized steel plate		
External dimension H x W x D		mm	250 x 900 x 732	250 x 900 x 732	250 x 1,100 x 732		
		in.	9-7/8 x 35-7/16 x 28-7/8	9-7/8 x 35-7/16 x 28-7/8	9-7/8 x 43-5/16 x 28-7/8	9-7/8 x 43-5/16 x 28-7/8	
Net weight		kg (lbs)	24 (53)	26 (58)	29 (64)		
Heat exchanger		Cross fin (Aluminum fin and copper tube)	Cross fin (Aluminum fin and copper tube)	Cross fin (Aluminum fin and copper tube)	Cross fin (Aluminum fin and copper tube)		
FAN	Type x Quantity		Sirocco fan x 2	Sirocco fan x 2	Sirocco fan x 2		
	*4 External static press.	Pa	35 - <50> - <70> - <100> - <150>	35 - <50> - <70> - <100> - <150>	40 - <50> - <70> - <100> - <150>	40 - <50> - <70> - <100> - <150>	
		mmH <sub>2</sub> O	3.6 - <5.1> - <7.1> - <10.2> - <15.3>	3.6 - <5.1> - <7.1> - <10.2> - <15.3>	4.1 - <5.1> - <7.1> - <10.2> - <15.3>	4.1 - <5.1> - <7.1> - <10.2> - <15.3>	
	Motor Type		DC motor	DC motor	DC motor	DC motor	
	Motor output kW		0.121	0.121	0.121	0.121	
	Driving mechanism		Direct-driven by motor	Direct-driven by motor	Direct-driven by motor	Direct-driven by motor	
	Air flow rate		(Low-Mid-High)		(Low-Mid-High)		
			m <sup>3</sup> /min	12.0 - 14.5 - 17.0	13.5 - 16.0 - 19.0	14.5 - 18.0 - 21.0	14.5 - 18.0 - 21.0
			L/s	200 - 242 - 283	225 - 267 - 317	242 - 300 - 350	242 - 300 - 350
	cfm		424 - 512 - 600	477 - 565 - 671	512 - 636 - 742	512 - 636 - 742	
Sound pressure level (measured in anechoic room)		(Low-Mid-High)		(Low-Mid-High)			
*2, 5 *2, 6 dB <A>		24.0-31.0-34.0		27.0-31.0-35.0			
		21.0-28.0-31.0		24.0-28.0-32.0			
Insulation material		EPS, Polystyrene foam, Urethane foam	EPS, Polystyrene foam, Urethane foam	EPS, Polystyrene foam, Urethane foam	EPS, Polystyrene foam, Urethane foam		
Air filter		PP honeycomb fabric.	PP honeycomb fabric.	PP honeycomb fabric.	PP honeycomb fabric.		
Protection device		Fuse	Fuse	Fuse	Fuse		
Refrigerant control device		LEV	LEV	LEV	LEV		
Connectable outdoor unit		R32, R410A CITY MULTI	R32, R410A CITY MULTI	R32, R410A CITY MULTI	R32, R410A CITY MULTI		
Refrigerant piping diameter	Liquid	6.35 (1/4)Braze	9.52 (3/8)Braze	9.52 (3/8)Braze	9.52 (3/8)Braze		
	Gas	12.7 (1/2)Braze	15.88 (5/8)Braze	15.88 (5/8)Braze	15.88 (5/8)Braze		
Field drain pipe size		mm (in.)	O.D.32 (1-1/4")	O.D.32 (1-1/4")	O.D.32 (1-1/4")		
Drawing	External		KB94C15Z	KB94C15Z	KB94C15Z		
	Wiring		KB94C15X	KB94C15X	KB94C15X		
	Refrigerant cycle		-	-	-		
Standard attachment	Document		Installation Manual, Instruction Book	Installation Manual, Instruction Book	Installation Manual, Instruction Book		
	Accessory		Washer, Drain hose, Tie band	Washer, Drain hose, Tie band	Washer, Drain hose, Tie band		
Optional parts	Filter box	PAC-KE92TB-E	PAC-KE92TB-E	PAC-KE93TB-E	PAC-KE93TB-E		
Remarks		* Details on foundation work, duct work, insulation work, electrical wiring, power source switch, and other items shall be referred to the Installation Manual. * Due to continuing improvement, above specifications may be subject to change without notice.					

Notes:	Unit converter
1. Nominal cooling conditions Indoor: 27°CDB/19°CWB (81°FDB/66°FWB), Outdoor: 35°CDB (95°FDB) Pipe length: 7.5m (24-9/16ft.), Level difference: 0m (0ft.)	kcal = kW x 860
2. The values are measured at the factory setting of external static pressure.	BTU/h = kW x 3,412
3. Nominal heating conditions Indoor: 20°CDB (68°FDB), Outdoor: 7°CDB/6°CWB (45°FDB/43°FWB) Pipe length: 7.5m (24-9/16ft.), Level difference: 0m (0ft.)	cfm = m <sup>3</sup> /min x 35.31
4. The factory setting of airflow mode and external static pressure mode is shown without < >. Refer to "Fan characteristics curves", according to the external static pressure, in DATA BOOK for the usable range of air flow rate.	lbs = kg/0.4536
5. Measured in anechoic room with a 1 m air inlet duct and 2 m air outlet duct attached to the unit and 1.5 m below the unit.	*Above specification data is subject to rounding variation.
6. Measured in anechoic room with a 2 m air inlet duct and 2 m air outlet duct attached to the unit and 1.5 m below the unit.	
* The sound pressure level measured by the conventional method in JIS.	
* R32 is flammable, and certain restrictions apply to the installation of units. For detail, refer to the section in the Databook on installation restrictions.	

# 1. SPECIFICATIONS

Ceiling concealed (Medium static pressure type)

Model		PEFY-M100VMAL-A	PEFY-M125VMAL-A	PEFY-M140VMAL-A		
Power source		1-phase 220-230-240 V 50 Hz	1-phase 220-230-240 V 50 Hz	1-phase 220-230-240 V 50 Hz		
Cooling capacity (Nominal)	*1 kW	11.2	14.0	16.0		
	*1 kcal/h	9,600	12,000	13,800		
	*1 BTU/h	38,200	47,800	54,600		
	*2 Power input kW	0.140	0.197	0.206		
	*2 Current input A	1.01-0.97-0.93	1.29-1.23-1.18	1.40-1.34-1.28		
	Heating capacity (Nominal)					
	*3 kW	12.5	16.0	18.0		
	*3 kcal/h	10,800	13,800	15,500		
	*3 BTU/h	42,700	54,600	61,400		
	*2 Power input kW	0.140	0.197	0.206		
	*2 Current input A	1.01-0.97-0.93	1.29-1.23-1.18	1.40-1.34-1.28		
	External finish		Galvanized steel plate	Galvanized steel plate	Galvanized steel plate	
External dimension H x W x D		mm	250 x 1,400 x 732	250 x 1,600 x 732		
		in.	9-7/8 x 55-1/8 x 28-7/8	9-7/8 x 55-1/8 x 28-7/8		
Net weight		kg (lbs)	36 (80)	37 (82)		
Heat exchanger		Cross fin (Aluminum fin and copper tube)	Cross fin (Aluminum fin and copper tube)	Cross fin (Aluminum fin and copper tube)		
FAN		Sirocco fan x 3	Sirocco fan x 3	Sirocco fan x 3		
*4	Type x Quantity		Sirocco fan x 3	Sirocco fan x 3		
	External static press.	Pa	40 - <50> - <70> - <100> - <150>	<40> - 50 - <70> - <100> - <150>	<40> - 50 - <70> - <100> - <150>	
		mmH <sub>2</sub> O	4.1 - <5.1> - <7.1> - <10.2> - <15.3>	<4.1> - 5.1 - <7.1> - <10.2> - <15.3>	<4.1> - 5.1 - <7.1> - <10.2> - <15.3>	
	Motor Type		DC motor	DC motor	DC motor	
	Motor output	kW	0.300	0.300	0.300	
	Driving mechanism		Direct-driven by motor	Direct-driven by motor	Direct-driven by motor	
	Air flow rate		(Low-Mid-High)	(Low-Mid-High)	(Low-Mid-High)	
			m <sup>3</sup> /min	23.0 - 28.0 - 32.0	28.0 - 34.0 - 37.0	29.5 - 35.5 - 40.0
			L/s	383 - 467 - 533	467 - 567 - 617	492 - 592 - 667
			cfm	812 - 989 - 1,130	989 - 1,201 - 1,306	1,042 - 1,254 - 1,412
Sound pressure level (measured in anechoic room)		(Low-Mid-High)	(Low-Mid-High)	(Low-Mid-High)		
*2, 5 *2, 6	dB <A>	30.0-35.0-38.0	34.0-38.0-40.0	33.0-37.0-40.0		
		27.0-32.0-35.0	31.0-35.0-37.0	30.0-34.0-37.0		
Insulation material		EPS, Polystyrene foam, Urethane foam	EPS, Polystyrene foam, Urethane foam	EPS, Polystyrene foam, Urethane foam		
Air filter		PP honeycomb fabric.	PP honeycomb fabric.	PP honeycomb fabric.		
Protection device		Fuse	Fuse	Fuse		
Refrigerant control device		LEV	LEV	LEV		
Connectable outdoor unit		R32, R410A CITY MULTI	R32, R410A CITY MULTI	R32, R410A CITY MULTI		
Refrigerant piping diameter	Liquid	mm (in.)	9.52 (3/8)Braze	9.52 (3/8)Braze		
	Gas	mm (in.)	15.88 (5/8)Braze	15.88 (5/8)Braze		
Field drain pipe size		mm (in.)	O.D.32 (1-1/4")	O.D.32 (1-1/4")		
Drawing	External		KB94C15Z	KB94C15Z		
	Wiring		KB94C15X	KB94C15X		
	Refrigerant cycle		-	-		
Standard attachment	Document		Installation Manual, Instruction Book	Installation Manual, Instruction Book		
	Accessory		Washer, Drain hose, Tie band	Washer, Drain hose, Tie band		
Optional parts	Filter box		PAC-KE94TB-E	PAC-KE95TB-E		
Remarks		* Details on foundation work, duct work, insulation work, electrical wiring, power source switch, and other items shall be referred to the Installation Manual. * Due to continuing improvement, above specifications may be subject to change without notice.				

Notes:	Unit converter
1. Nominal cooling conditions Indoor: 27°CDB/19°CWB (81°FDB/66°FWB), Outdoor: 35°CDB (95°FDB) Pipe length: 7.5m (24-9/16ft.), Level difference: 0m (0ft.)	kcal = kW x 860
2. The values are measured at the factory setting of external static pressure.	BTU/h = kW x 3,412
3. Nominal heating conditions Indoor: 20°CDB (68°FDB), Outdoor: 7°CDB/6°CWB (45°FDB/43°FWB) Pipe length: 7.5m (24-9/16ft.), Level difference: 0m (0ft.)	cfm = m <sup>3</sup> /min x 35.31
4. The factory setting of airflow mode and external static pressure mode is shown without < > . Refer to "Fan characteristics curves", according to the external static pressure, in DATA BOOK for the usable range of air flow rate.	lbs = kg/0.4536
5. Measured in anechoic room with a 1 m air inlet duct and 2 m air outlet duct attached to the unit and 1.5 m below the unit.	*Above specification data is
6. Measured in anechoic room with a 2 m air inlet duct and 2 m air outlet duct attached to the unit and 1.5 m below the unit.	subject to rounding variation.
* The sound pressure level measured by the conventional method in JIS.	
* R32 is flammable, and certain restrictions apply to the installation of units. For detail, refer to the section in the Databook on installation restrictions.	



## 2. EXTERNAL DIMENSIONS

Ceiling concealed (Medium static pressure type)

PEFY-M-VMA(L)-A

### PEFY-M20, 25, 32, 40, 50, 63, 71, 80, 100, 125, 140VMA-A

Unit: mm

- Note 1. Use M10 screw for the Suspension bolt (field supply).  
 2. Keep the service space for the maintenance at the bottom.  
 3. This chart indicates for PEFY-M71:80VMA-A models, which have 2 fans. PEFY-M20:25-32VMA-A models have 1 fan. PEFY-M40-50-63VMA-A models have 2 fans. PEFY-M100-125-140VMA-A models have 3 fans.  
 4. In case of the inlet duct is used, remove the air filter (supply with the unit), then install the filter (field supply) at suction side.

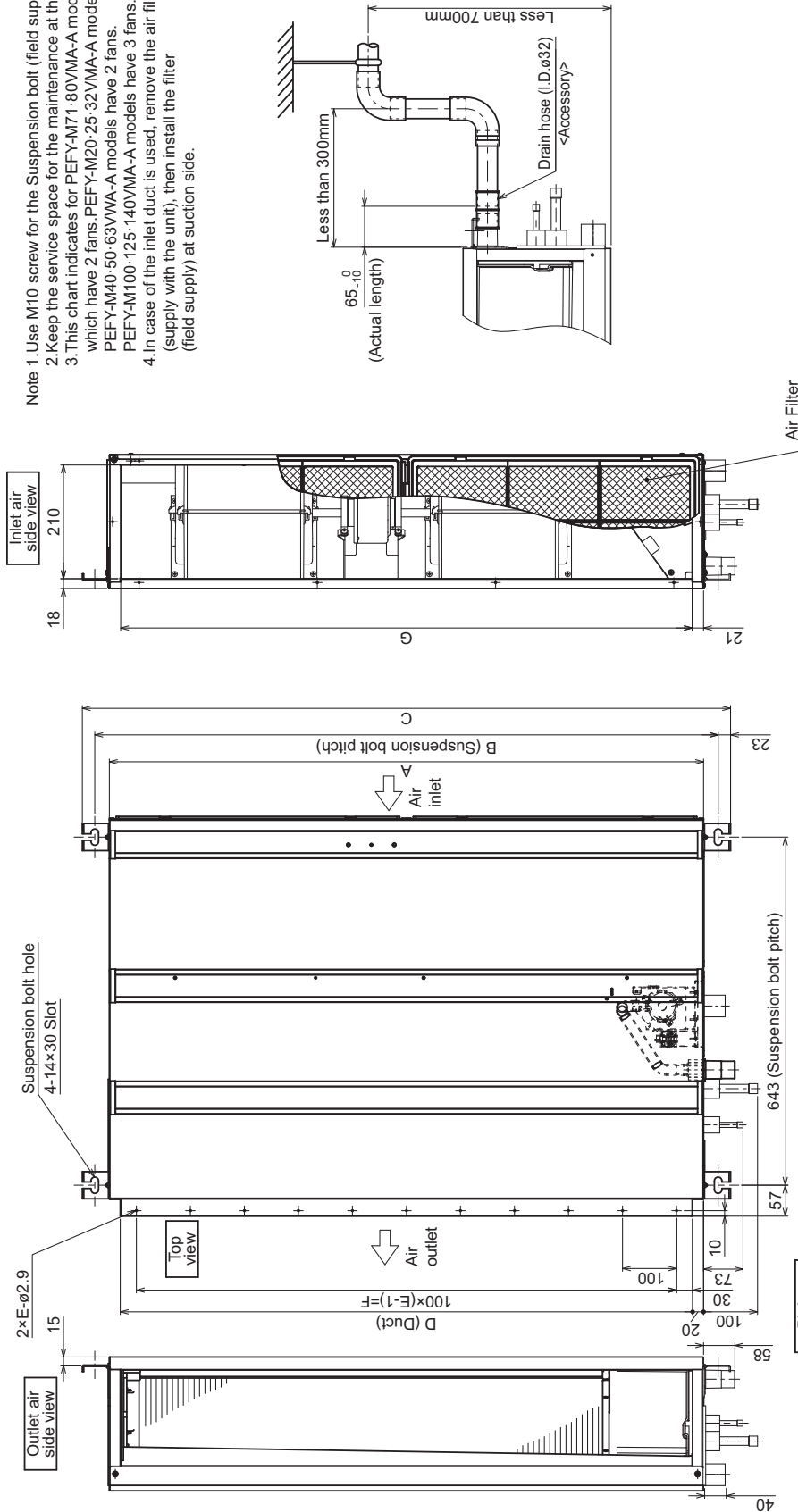

Model	A	B	C	D	E	F	G	① Gas pipe	② Liquid pipe
PEFY-M20, 25, 32VMA-A	700	754	800	660	7	600	658	ø12.7	ø6.35
PEFY-M40, 50VMA-A	900	954	1000	860	9	800	858		
PEFY-M63VMA-A	900	954	1000	860	9	800	858		
PEFY-M71, 80VMA-A	1100	1154	1200	1060	11	1000	1058	ø15.88	ø9.52
PEFY-M100, 125VMA-A	1400	1454	1500	1360	14	1300	1358		
PEFY-M140VMA-A	1600	1654	1700	1560	16	1500	1558		

PEFY-M20, 25, 32, 40, 50, 63, 71, 80, 100, 125, 140VMA-A

Unit: mm

[Maintenance access space]  
 Secure enough access space to allow for the maintenance, inspection, and replacement of the motor, fan, drain pump, heat exchanger, and control box in one of the following ways.  
 Select an installation site for the indoor unit so that its maintenance access space will not be obstructed by beams or other objects.

(1) When a space of 300mm or more is available below the unit between the unit and the ceiling. (Fig.1)

· Create access door 1 and 2 (450×450mm each) as shown in Fig.2.  
 (Access door 2 is not required if enough space is available below the unit for a maintenance worker to work in.)

(2) When a space of less than 300mm is available below the unit between the unit and the ceiling.

(At least 20mm of space should be left below the unit as shown in Fig.3.)

· Create access door 1 diagonally below the control box and access door 3 below the unit as shown in Fig.4.

or

· Create access door 4 below the control box and the unit as shown in Fig.5.

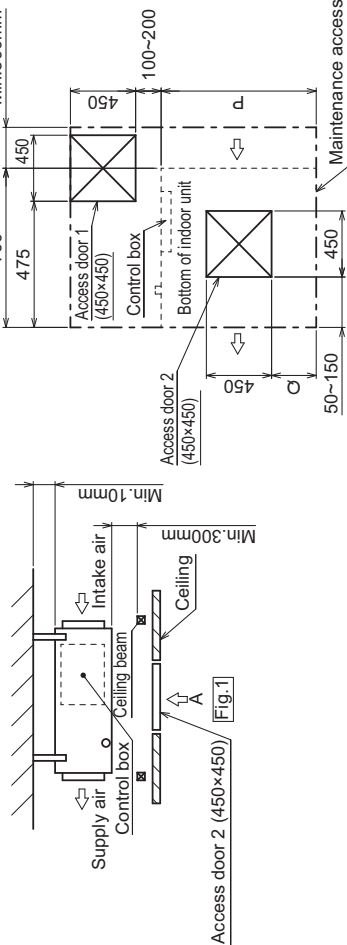

Fig.2 (Viewed from the direction of the arrow A)

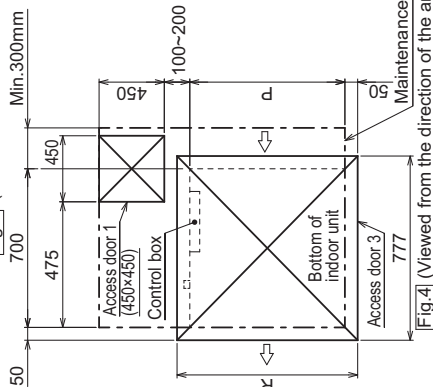

Fig.4 (Viewed from the direction of the arrow B)

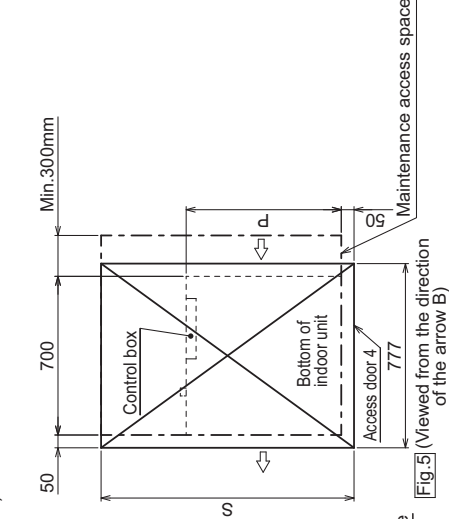

Fig.5 (Viewed from the direction of the arrow B)

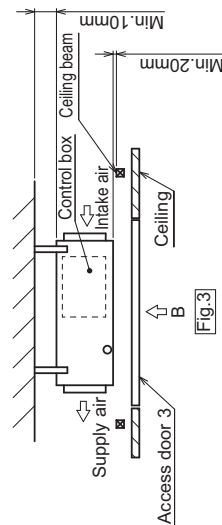
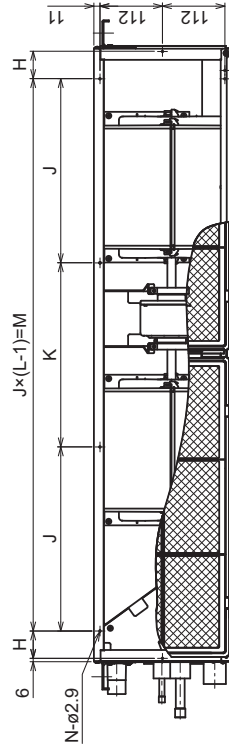

Fig.3

Model	H	J	K	L	M	N	P	Q	R	S
PEFY-M20, 25, 32VMA-A	44	150	300				700	50~150	800	1300
PEFY-M40, 50, 63VMA-A	54	260		4	780	10	900	150~250	1000	1500
PEFY-M71, 80VMA-A	49	330		4	990	10	1100	250~350	1200	1700
PEFY-M100, 125VMA-A	54	320		5	1280	12	1400	400~500	1500	2000
PEFY-M140VMA-A	54	370		5	1480	12	1600	500~600	1700	2200

PEFY-M20, 25, 32, 40, 50, 63, 71, 80, 100, 125, 140VMA-A Suction filter box built-in-specification

Unit: mm

- Note 1. Use M10 screw for the Suspension bolt (field supply).  
 2. Keep the service space for the maintenance at the bottom.  
 3. This chart indicates for PEFY-M71-80VMA-A models, which have 2 fans. PEFY-M20-25-32VMA-A models have 1 fan. PEFY-M40-50-63VMA-A models have 2 fans. PEFY-M100-125-140VMA-A models have 3 fans.  
 4. Use air filter installed with indoor unit.

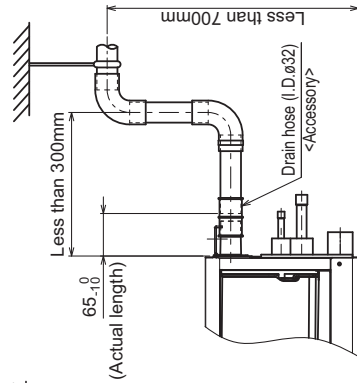
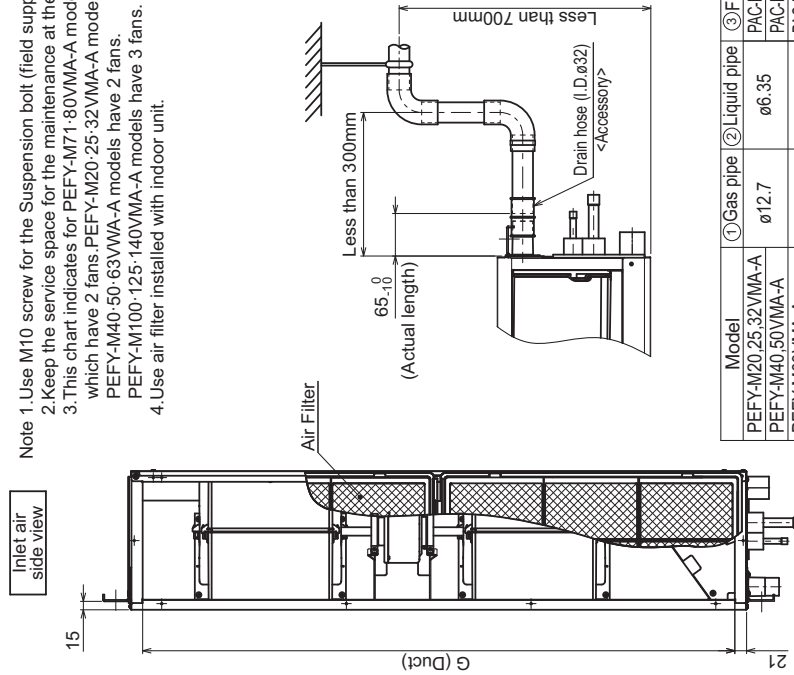

Model	① Gas pipe	② Liquid pipe	③ Filter box
PEFY-M20,25,32VMA-A	ø12.7	ø6.35	PAC-KE91TB-E
PEFY-M40,50VMA-A			PAC-KE92TB-E
PEFY-M63VMA-A			PAC-KE93TB-E
PEFY-M71,80VMA-A	ø15.88	ø9.52	PAC-KE94TB-E
PEFY-M100,125VMA-A			PAC-KE95TB-E
PEFY-M140VMA-A			PAC-KE95TB-E

Model	A	B	C	D	E	F	G	H	J
PEFY-M20,25,32VMA-A	700	754	800	660	7	600	658	7	600
PEFY-M40,50,63VMA-A	900	954	1000	860	9	800	858	9	800
PEFY-M71,80VMA-A	1100	1154	1200	1060	11	1000	1058	11	1000
PEFY-M100,125VMA-A	1400	1454	1500	1360	14	1300	1358	14	1300
PEFY-M140VMA-A	1600	1654	1700	1560	16	1500	1558	16	1500

<Suction filter box built-in-specification>

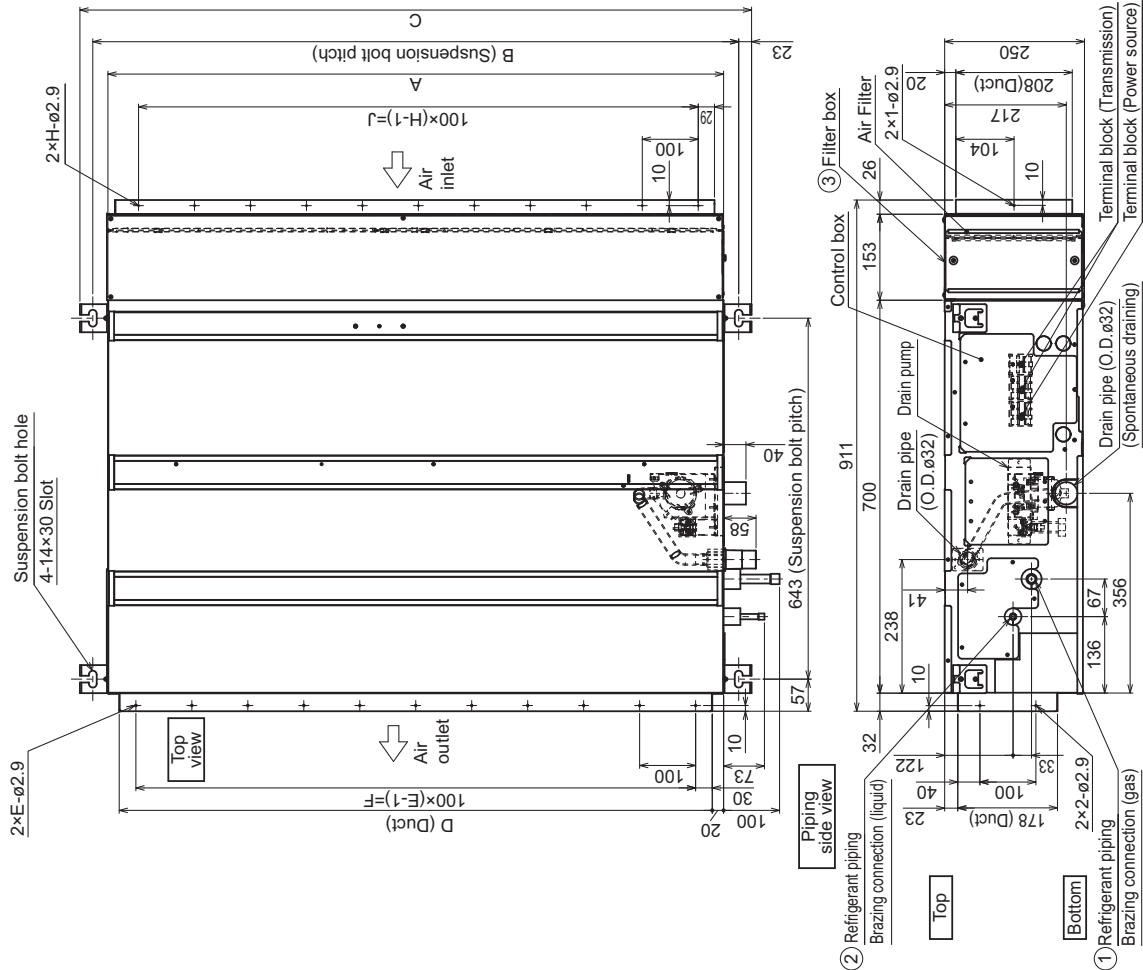

PEFY-M-VMA(L)-A

PEFY-M20, 25, 32, 40, 50, 63, 71, 80, 100, 125, 140VMA-A Suction filter box built-in-specification

Unit: mm

[Maintenance access space]  
 Secure enough access space to allow for the maintenance, inspection, and replacement of the motor, fan, drain pump, heat exchanger, and control box in one of the following ways.  
 Select an installation site for the indoor unit so that its maintenance access space will not be obstructed by beams or other objects.

- (1) When a space of 300mm or more is available below the unit between the unit and the ceiling. (Fig.1)
  - Create access door 1 and 2 (450×450mm each) as shown in Fig.2.
  - (Access door 2 is not required if enough space is available below the unit for a maintenance worker to work in.)
- (2) When a space of less than 300mm is available below the unit between the unit and the ceiling. (At least 20mm of space should be left below the unit as shown in Fig.3.)
  - Create access door 1 diagonally below the control box and access door 3 below the unit as shown in Fig.4.
  - or
  - Create access door 4 below the control box and the unit as shown in Fig.5.

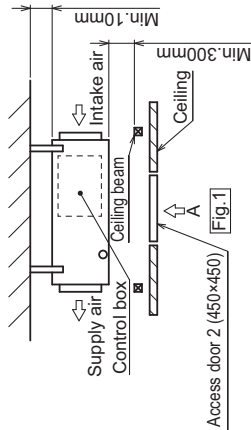

Fig.2 (Viewed from the direction of the arrow A)

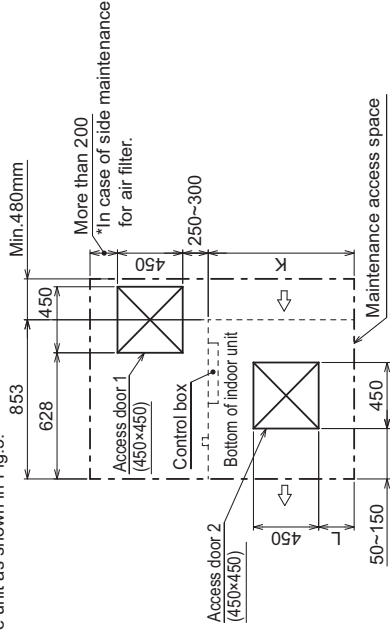

Fig.3 (Viewed from the direction of the arrow B)

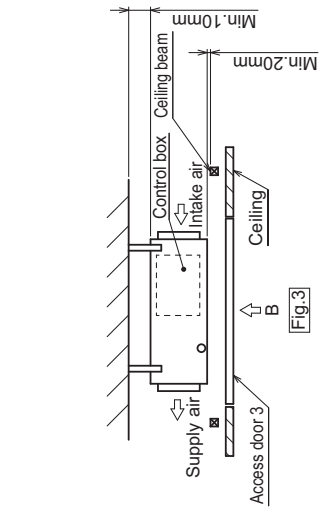

Fig.4 (Viewed from the direction of the arrow B)

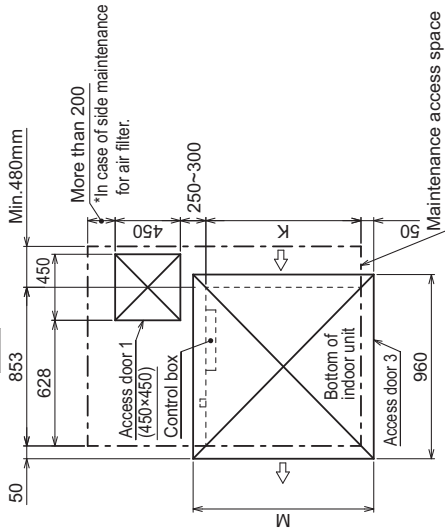
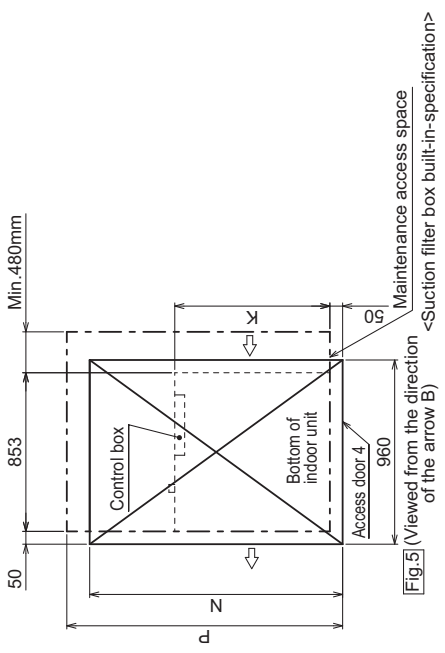

Fig.5 (Viewed from the direction of the arrow B)



\* Dimension 'P' is in case of side maintenance for air filter.

Model	K	L	M	N	P*
PEFY-M20, 25, 32VMA-A	700	50~150	800	1300	1450
PEFY-M40, 50, 63VMA-A	900	150~250	1000	1500	1850
PEFY-M71, 80VMA-A	1100	250~350	1200	1700	
PEFY-M100, 125VMA-A	1400	400~500	1500	2000	2150
PEFY-M140VMA-A	1600	500~600	1700	2200	2550

## 2. EXTERNAL DIMENSIONS

Ceiling concealed (Medium static pressure type)

### PEFY-M20, 25, 32, 40, 50, 63, 71, 80, 100, 125, 140VMAL-A

Unit: mm

- Note 1. Use M10 screw for the Suspension bolt (field supply).  
 2. Keep the service space for the maintenance at the bottom.  
 3. This chart indicates for PEFY-M71~80VMAL-A models, which have 2 fans. PEFY-M20, 25, 32VMAL-A models have 1 fan. PEFY-M40~50, 63VMAL-A models have 2 fans. PEFY-M100~125, 140VMAL-A models have 3 fans.  
 4. In case of the inlet duct is used, remove the air filter (supply with the unit), then install the filter (field supply) at suction side.

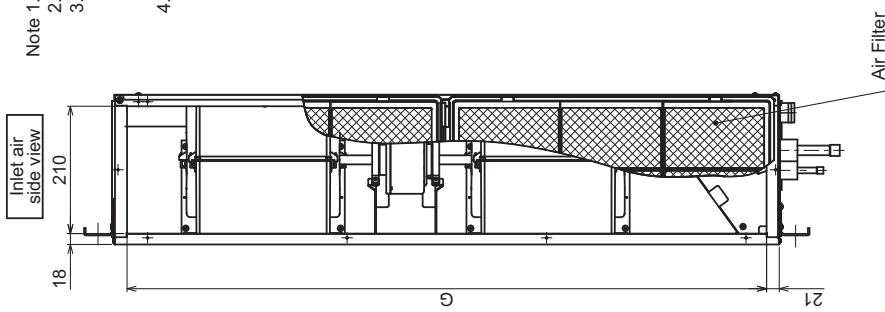
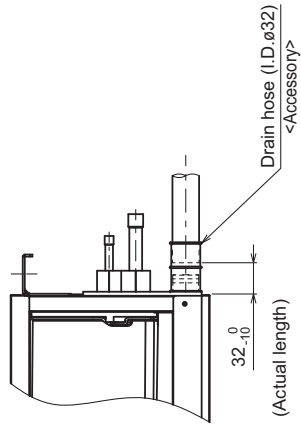

Model	A	B	C	D	E	F	G	① Gas pipe	② Liquid pipe
PEFY-M20, 25, 32VMAL-A	700	754	800	660	7	600	658	ø12.7	ø6.35
PEFY-M40, 50VMAL-A	900	954	1000	860	9	800	858		
PEFY-M63VMAL-A	900	954	1000	860	9	800	858		
PEFY-M71, 80VMAL-A	1100	1154	1200	1060	11	1000	1058	ø15.88	ø9.52
PEFY-M100, 125VMAL-A	1400	1454	1500	1360	14	1300	1358		
PEFY-M140VMAL-A	1600	1654	1700	1560	16	1500	1558		

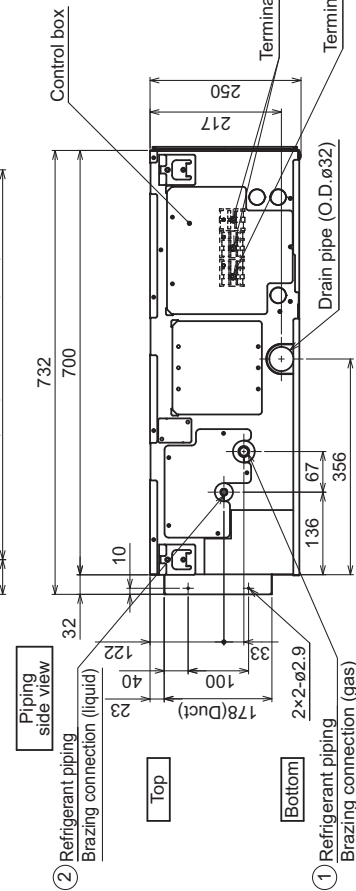
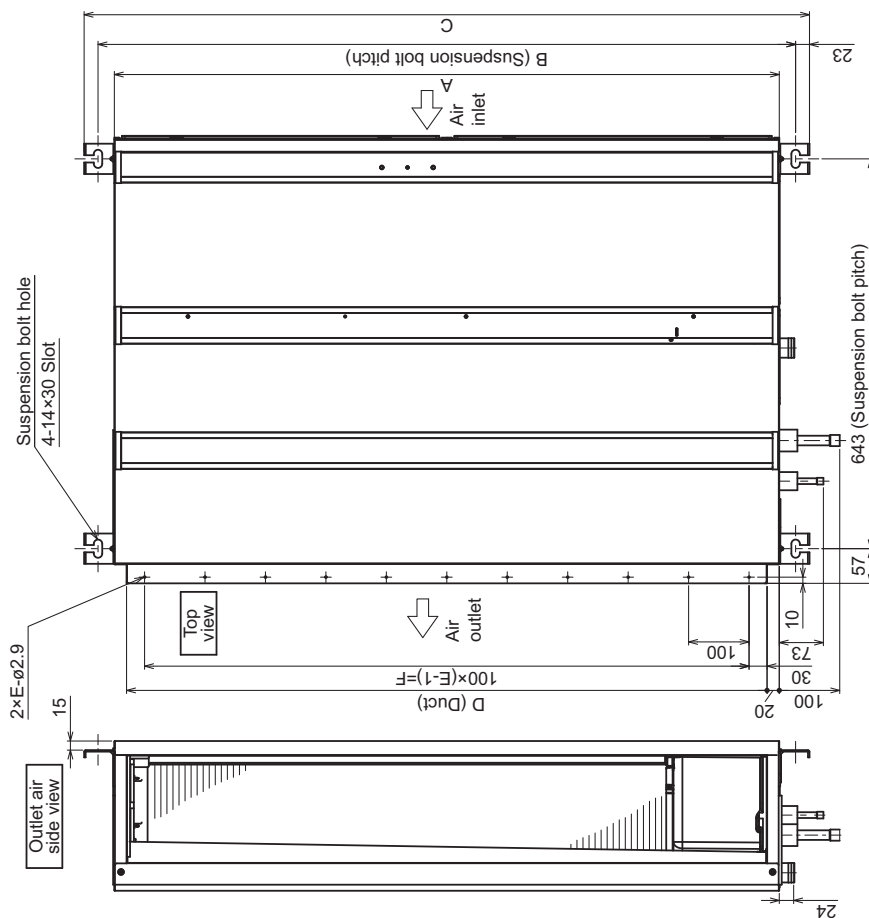

PEFY-M20, 25, 32, 40, 50, 63, 71, 80, 100, 125, 140VMAL-A

Unit: mm

[Maintenance access space]  
 Secure enough access space to allow for the maintenance, inspection, and replacement of the motor, fan, heat exchanger, and control box in one of the following ways.  
 Select an installation site for the indoor unit so that its maintenance access space will not be obstructed by beams or other objects.  
 (1) When a space of 300mm or more is available below the unit between the unit and the ceiling, (Fig. 1)  
 · Create access door 1 and 2 (450×450mm each) as shown in Fig. 2.  
 (Access door 2 is not required if enough space is available below the unit for a maintenance worker to work in.)

(2) When a space of less than 300mm is available below the unit between the unit and the ceiling.  
 (At least 20mm of space should be left below the unit as shown in Fig. 3.)  
 · Create access door 1 diagonally below the control box and access door 3 below the unit as shown in Fig. 4.  
 or  
 · Create access door 4 below the control box and the unit as shown in Fig. 5.

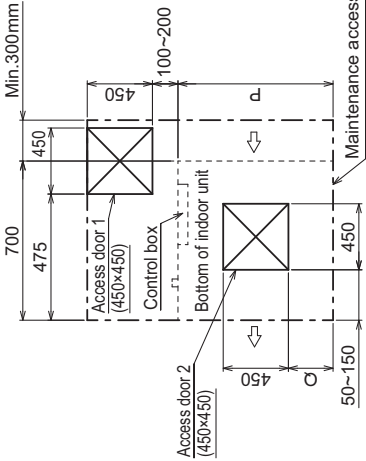
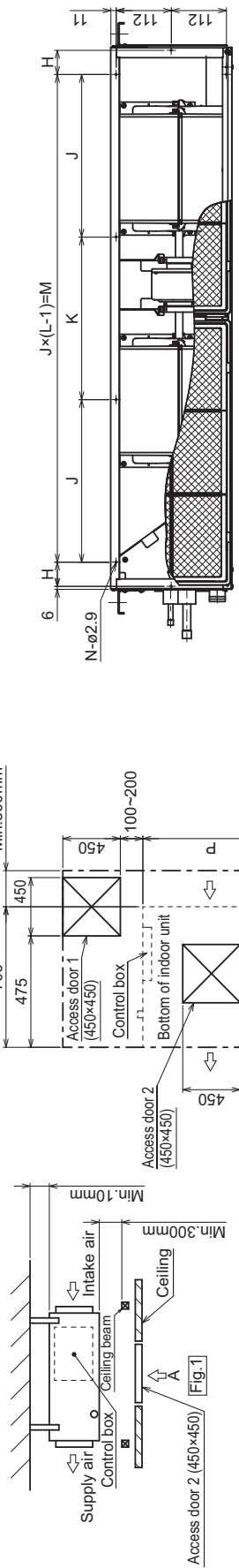

Fig. 2 (Viewed from the direction of the arrow A)

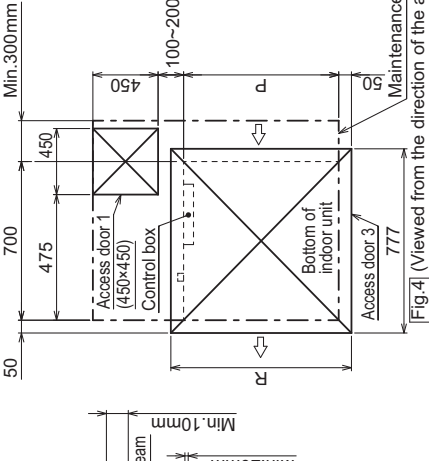

Fig. 4 (Viewed from the direction of the arrow B)

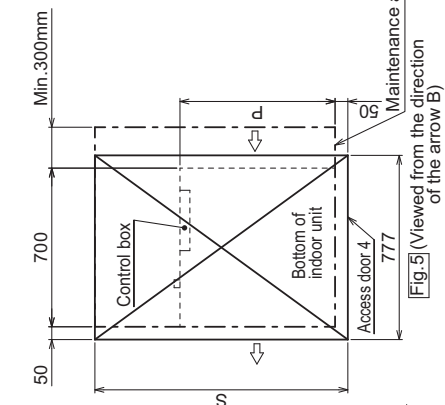

Fig. 5 (Viewed from the direction of the arrow B)

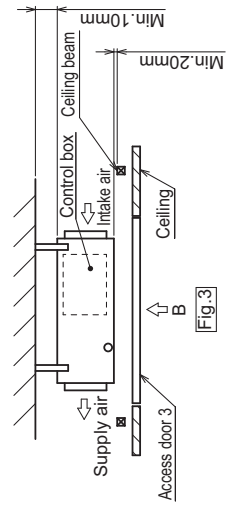

Fig. 3

Model	H	J	K	L	M	N	P	Q	R	S
PEFY-M20, 25, 32VMAL-A	44	150	300	4	780	10	700	50~150	800	1300
PEFY-M40, 50, 63VMAL-A	54	260	4	900	150~250	1000	1500			
PEFY-M71, 80VMAL-A	49	330	4	990	10	1100	250~350	1200	1700	
PEFY-M100, 125VMAL-A	54	320	5	1280	12	1400	400~500	1500	2000	
PEFY-M140VMAL-A	54	370	5	1480	12	1600	500~600	1700	2200	

PEFY-M-VMA(L)-A

PEFY-M20, 25, 32, 40, 50, 63, 71, 80, 100, 125, 140VMA-A Suction filter box built-in-specification

Unit: mm

- Note 1. Use M10 screw for the Suspension bolt (field supply).  
 2. Keep the service space for the maintenance at the bottom.  
 3. This chart indicates for PEFY-M71-80VMA-A models, which have 2 fans. PEFY-M20-25-32VMA-A models have 1 fan. PEFY-M40-50-63VMA-A models have 2 fans. PEFY-M100-125-140VMA-A models have 3 fans.  
 4. Use air filter installed with indoor unit.

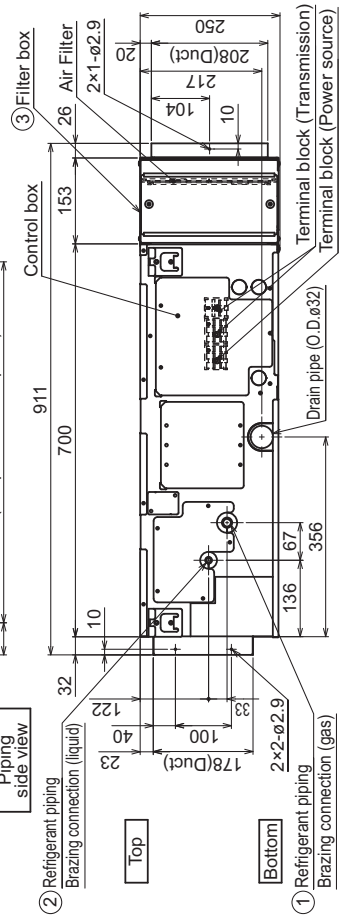
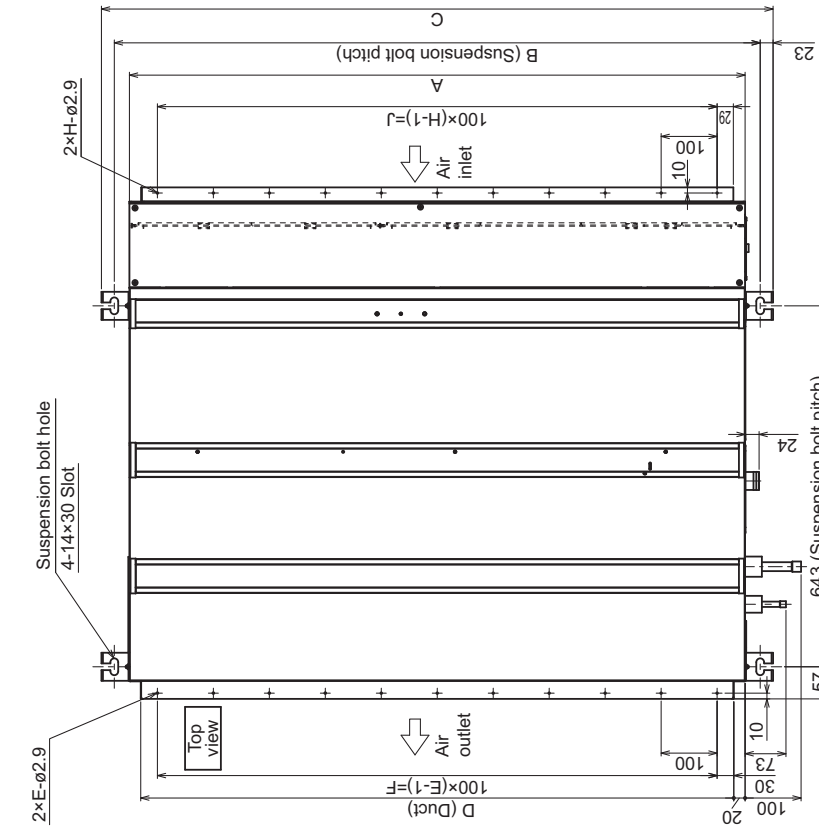
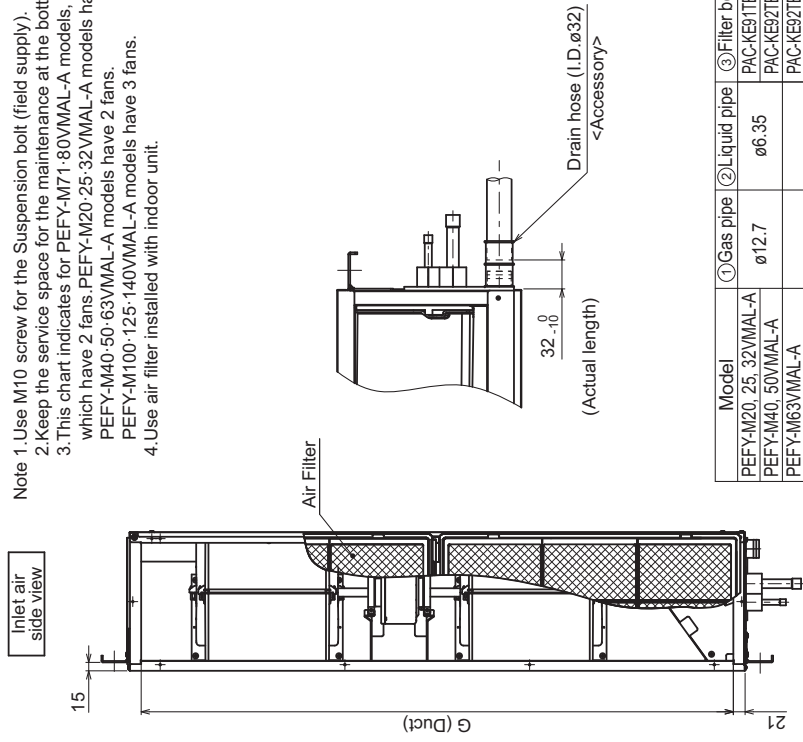

Model	① Gas pipe	② Liquid pipe	③ Filter box
PEFY-M20, 25, 32VMA-A	ø12.7	ø6.35	PAC-KE97TB-E
PEFY-M40, 50VMA-A			PAC-KE97TB-E
PEFY-M63VMA-A	ø15.88	ø9.52	PAC-KE97TB-E
PEFY-M71, 80VMA-A			PAC-KE93TB-E
PEFY-M100, 125VMA-A			PAC-KE94TB-E
PEFY-M140VMA-A			PAC-KE93TB-E

Model	A	B	C	D	E	F	G	H	J
PEFY-M20, 25, 32VMA-A	700	754	800	660	7	600	658	7	600
PEFY-M40, 50, 63VMA-A	900	954	1000	860	9	800	858	9	800
PEFY-M71, 80VMA-A	1100	1154	1200	1060	11	1000	1058	11	1000
PEFY-M100, 125VMA-A	1400	1454	1500	1360	14	1300	1358	14	1300
PEFY-M140VMA-A	1600	1654	1700	1560	16	1500	1558	16	1500

<Suction filter box built-in-specification>

PEFY-M20, 25, 32, 40, 50, 63, 71, 80, 100, 125, 140VMAL-A Suction filter box built-in-specification

Unit: mm

[Maintenance access space]  
Secure enough access space to allow for the maintenance, inspection, and replacement of the motor, fan, heat exchanger, and control box in one of the following ways.  
Select an installation site for the indoor unit so that its maintenance access space will not be obstructed by beams or other objects.

- (1) When a space of 300mm or more is available below the unit between the unit and the ceiling. (Fig. 1)
  - Create access door 1 and 2 (450×450mm each) as shown in Fig. 2.
  - (Access door 2 is not required if enough space is available below the unit for a maintenance worker to work in.)
- (2) When a space of less than 300mm is available below the unit between the unit and the ceiling. (At least 20mm of space should be left below the unit as shown in Fig. 3.)
  - Create access door 1 diagonally below the control box and access door 3 below the unit as shown in Fig. 4.
  - or
  - Create access door 4 below the control box and the unit as shown in Fig. 5.

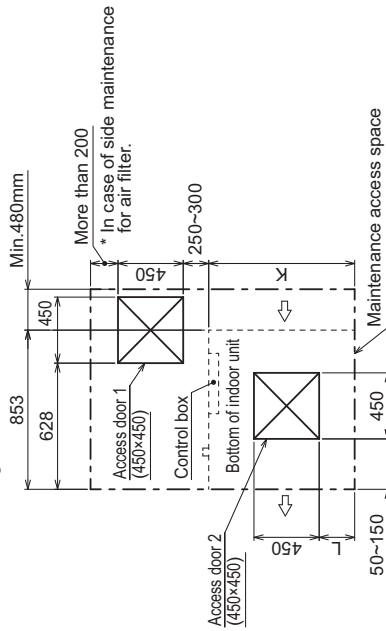
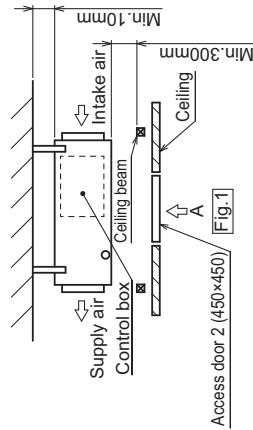

Fig. 2 (Viewed from the direction of the arrow A)

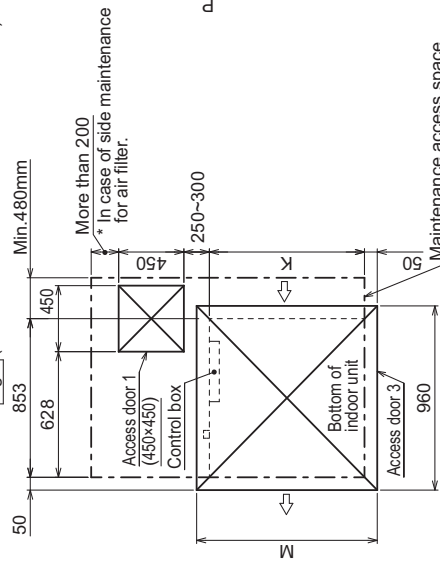

Fig. 4 (Viewed from the direction of the arrow B)

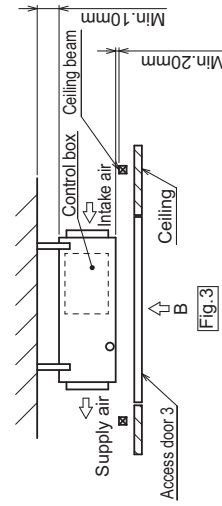

Fig. 3

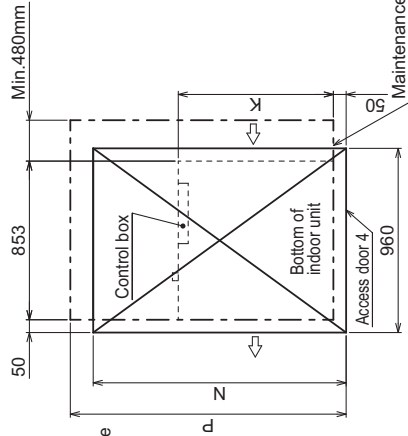

Fig. 5 (Viewed from the direction of the arrow B) <Suction filter box built-in-specification>

\* Dimension 'P' is in case of side maintenance for air filter.

Model	K	L	M	N	P*
PEFY-M20, 25, 32VMAL-A	700	50~150	800	1300	1450
PEFY-M40, 50, 63VMAL-A	900	150~250	1000	1500	1850
PEFY-M71, 80VMAL-A	1100	250~350	1200	1700	1700
PEFY-M100, 125VMAL-A	1400	400~500	1500	2000	2150
PEFY-M140VMAL-A	1600	500~600	1700	2200	2550



PEFY-M20, 25, 32, 40, 50, 63, 71, 80, 100, 125, 140VMA(L)-A

PEFY-M-VMA(L)-A

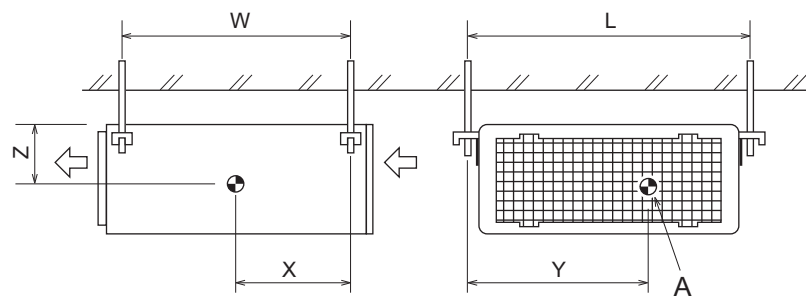

A : Center of gravity

(mm) [in]

Model name	W	L	X	Y	Z
PEFY-M20VMA(L)-A	643 [25 - 6/16]	754 [29 - 11/16]	330 [13]	300 [11 - 13/16]	130 [5 - 2/16]
PEFY-M25VMA(L)-A	643 [25 - 6/16]	754 [29 - 11/16]	330 [13]	300 [11 - 13/16]	130 [5 - 2/16]
PEFY-M32VMA(L)-A	643 [25 - 6/16]	754 [29 - 11/16]	330 [13]	300 [11 - 13/16]	130 [5 - 2/16]
PEFY-M40VMA(L)-A	643 [25 - 6/16]	954 [37 - 9/16]	340 [13 - 7/16]	375 [14 - 13/16]	130 [5 - 2/16]
PEFY-M50VMA(L)-A	643 [25 - 6/16]	954 [37 - 9/16]	340 [13 - 7/16]	375 [14 - 13/16]	130 [5 - 2/16]
PEFY-M63VMA(L)-A	643 [25 - 6/16]	954 [37 - 9/16]	340 [13 - 7/16]	375 [14 - 13/16]	130 [5 - 2/16]
PEFY-M71VMA(L)-A	643 [25 - 6/16]	1154 [45 - 7/16]	325 [12 - 13/16]	525 [20 - 11/16]	130 [5 - 2/16]
PEFY-M80VMA(L)-A	643 [25 - 6/16]	1154 [45 - 7/16]	325 [12 - 13/16]	525 [20 - 11/16]	130 [5 - 2/16]
PEFY-M100VMA(L)-A	643 [25 - 6/16]	1454 [57 - 4/16]	330 [13]	675 [26 - 10/16]	130 [5 - 2/16]
PEFY-M125VMA(L)-A	643 [25 - 6/16]	1454 [57 - 4/16]	330 [13]	675 [26 - 10/16]	130 [5 - 2/16]
PEFY-M140VMA(L)-A	643 [25 - 6/16]	1654 [65 - 2/16]	332 [13 - 2/16]	725 [28 - 9/16]	130 [5 - 2/16]

PEFY-M20, 25, 32, 40, 50, 63, 71, 80, 100, 125, 140VMA(L)-A

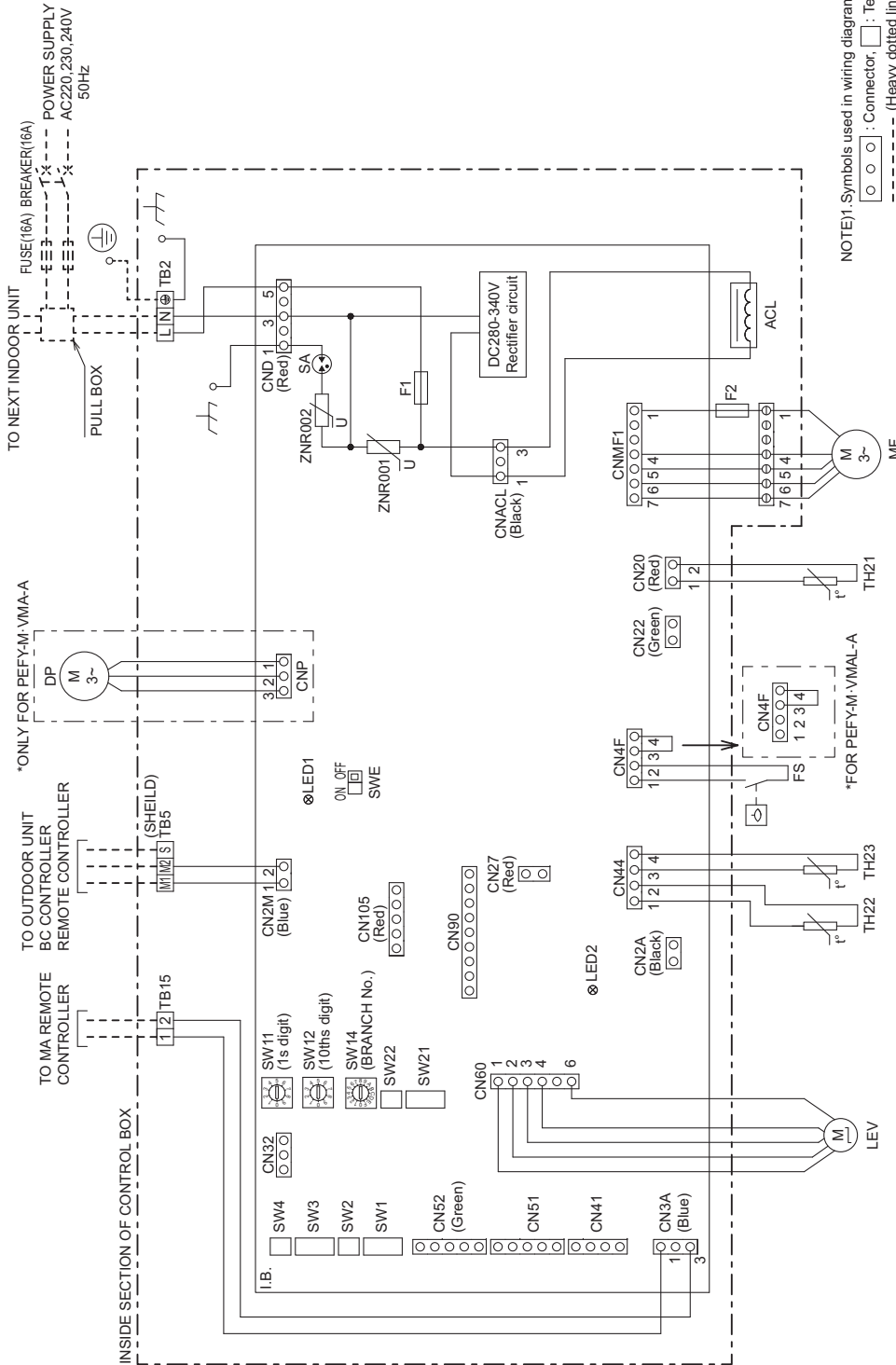

NOTE1: Symbols used in wiring diagram are  
 ○ ○ ○ ○ : Connector, □ : Terminal,  
 ○ ○ ○ ○ (Heavy dotted line): Field wiring,  
 2. Have all electric work done by a licensed electrician according to the local regulations.  
 3. Earth leakage circuit breaker should be set up on the wiring of the power supply.  
 4. To perform a drainage test for the drain pump turn on the SWE on the control board while the indoor unit is being powered.  
 \*Be sure to turn off the SWE after completing a drainage test or test run.

SYMBOL EXPLANATION

SYMBOL	NAME	SYMBOL	NAME	SYMBOL	NAME
ACL	AC reactor(Power factor improvement)	I.B.	Indoor controller board	SW1	Indoor controller board
DP	Drain Pump	SA	Arrester	SW2	Switch (for mode selection)
F2	Fuse DC400V 3A	F1	Fuse AC250V 6.3A	SW3	Switch (for capacity code)
FS	Float switch	ZNR001/002	Varistor	SW4	Switch (for mode selection)
MF	Fan Motor	CN2A	Connector (0-10V Analog input)	SW11	Switch (1s digit address set)
LEV	Linear expansion valve	CN22	Connector (Optional Thermistor)	SW12	Switch (10ths digit address set)
TB2	Power source terminal block	CN27	Connector (Damper)	SW14	Switch (BRANCH No.)
TB5	Transmission terminal block	CN32	Connector (Remote switch)	SW21	Switch (for static pressure selection)
TB15	Transmission terminal block	CN41	Connector (HA terminal-A)	SW22	Switch (Wireless pair No.)
TH21	Thermistor (inlet air temp. detection)	CN51	Connector (Centrally control)	SWE	Connector (emergency operation)
TH22	Thermistor (piping temp.detection(liquid))	CN52	Connector (Remote indication)	LED1	LED(Power supply)
TH23	Thermistor (piping temp.detection(gas))	CN90	Connector (Wireless)	LED2	LED(Remote controller supply)
		CN105	Connector (IT terminal)		

## 5-1. Sound levels

## 5-1-1. Sound levels (Measured point: With 1m air inlet duct and 2m air outlet duct)

PEFY-M-VMA(L)-A

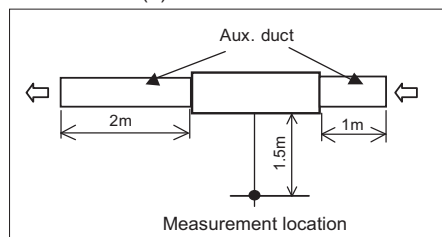

\* Measured in anechoic room.

Sound level at anechoic room: Low-Mid-High

Model	Sound level dB (A)					
	35Pa	40Pa	50Pa	70Pa	100Pa	150Pa
PEFY-M20, 25VMA(L)-A	21-25-27	-	23-26-29	22-27-30	24-30-33	28-34-38
PEFY-M32VMA(L)-A	23-27-30	-	24-28-33	25-30-34	27-32-35	31-35-39
PEFY-M40VMA(L)-A	23-28-31	-	24-31-33	27-31-35	29-33-37	32-37-41
PEFY-M50VMA(L)-A	24-31-34	-	28-32-36	28-33-38	31-36-40	33-38-42
PEFY-M63VMA(L)-A	27-31-35	-	30-33-38	30-35-39	32-37-41	35-40-44
PEFY-M71, 80VMA(L)-A	-	25-31-34	29-32-35	29-33-37	30-35-39	33-39-42
PEFY-M100VMA(L)-A	-	30-35-38	31-36-39	33-38-41	35-40-43	37-43-46
PEFY-M125VMA(L)-A	-	33-37-39	34-38-40	34-39-41	35-40-42	38-43-45
PEFY-M140VMA(L)-A	-	33-37-39	33-37-40	34-38-40	35-39-42	37-41-45

## 5-1-2. Sound levels (Measured point: With 2m air inlet duct and 2m air outlet duct)

PEFY-M-VMA(L)-A

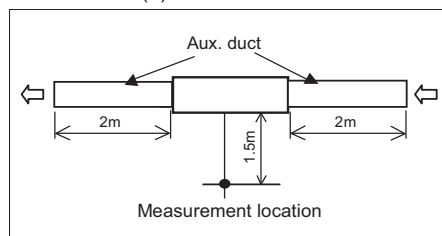

\* Measured in anechoic room.

Sound level at anechoic room: Low-Mid-High

Model	Sound level dB (A)					
	35Pa	40Pa	50Pa	70Pa	100Pa	150Pa
PEFY-M20, 25VMA(L)-A	18-22-24	-	20-23-26	19-24-27	21-27-30	25-31-35
PEFY-M32VMA(L)-A	20-24-27	-	21-25-30	22-27-31	24-29-32	28-32-36
PEFY-M40VMA(L)-A	20-25-28	-	21-28-30	24-28-32	26-30-34	29-34-38
PEFY-M50VMA(L)-A	21-28-31	-	25-29-33	25-30-35	28-33-37	30-35-39
PEFY-M63VMA(L)-A	24-28-32	-	27-30-35	27-32-36	29-34-38	32-37-41
PEFY-M71, 80VMA(L)-A	-	22-28-31	26-29-32	26-30-34	27-32-36	30-36-39
PEFY-M100VMA(L)-A	-	27-32-35	28-33-36	30-35-38	32-37-40	34-40-43
PEFY-M125VMA(L)-A	-	30-34-36	31-35-37	31-36-38	32-37-39	35-40-42
PEFY-M140VMA(L)-A	-	30-34-36	30-34-37	31-35-37	32-36-39	34-38-42

5-2. NC curves

5-2-1. NC curves (Sound level measured point: With 1m air inlet duct and 2m air outlet duct)

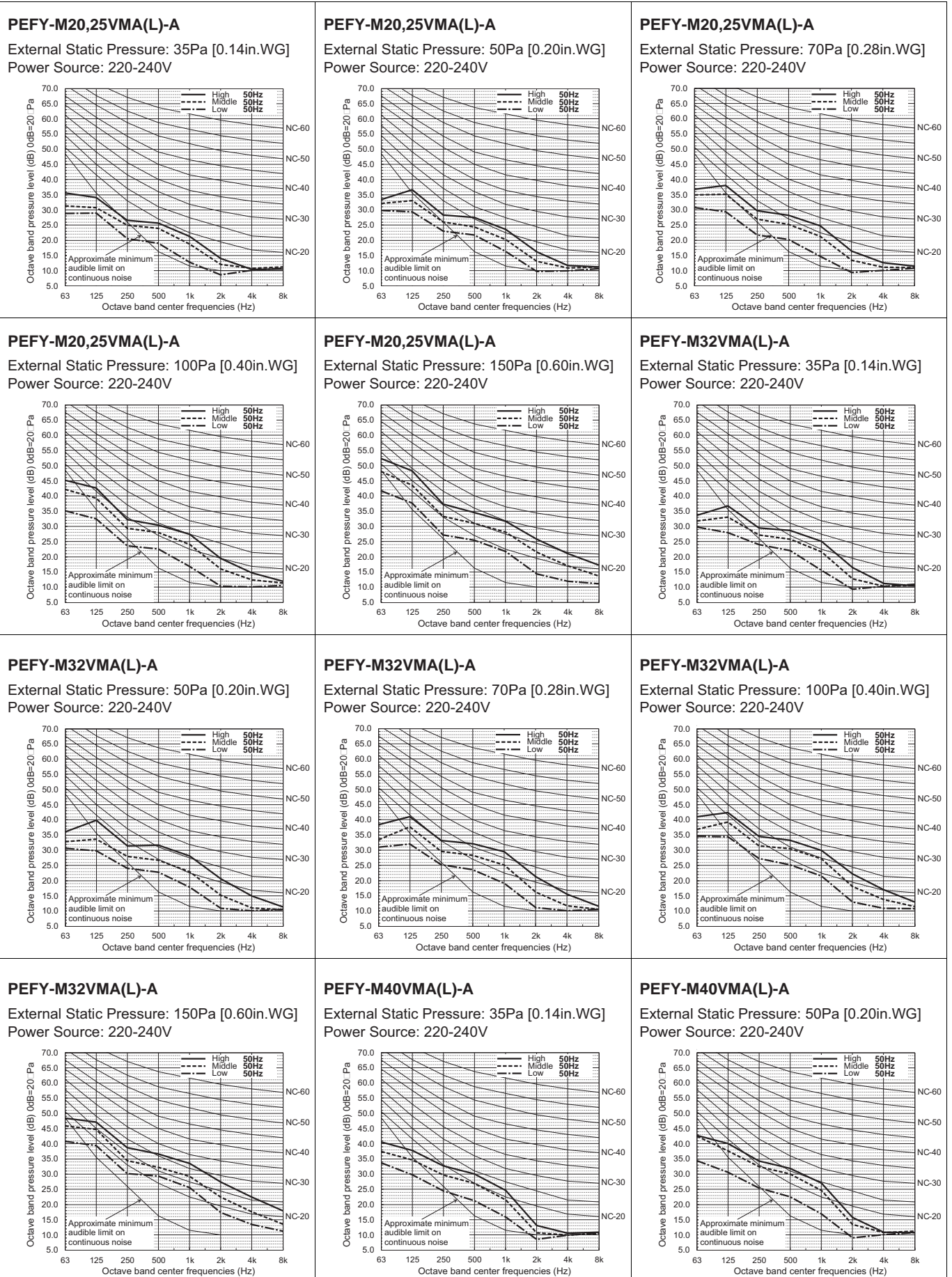

**PEFY-M40VMA(L)-A**

External Static Pressure: 70Pa [0.28in.WG]  
Power Source: 220-240V

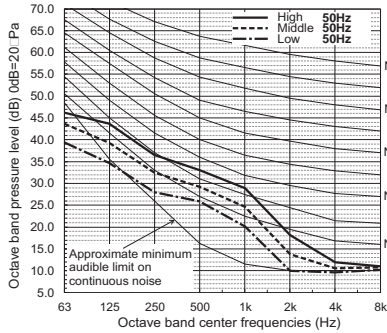

**PEFY-M40VMA(L)-A**

External Static Pressure: 100Pa [0.40in.WG]  
Power Source: 220-240V

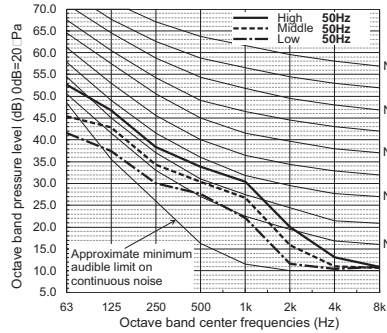

**PEFY-M40VMA(L)-A**

External Static Pressure: 150Pa [0.60in.WG]  
Power Source: 220-240V

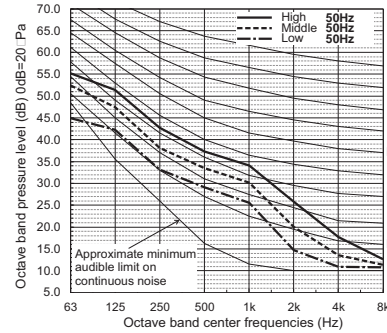

**PEFY-M50VMA(L)-A**

External Static Pressure: 35Pa [0.14in.WG]  
Power Source: 220-240V

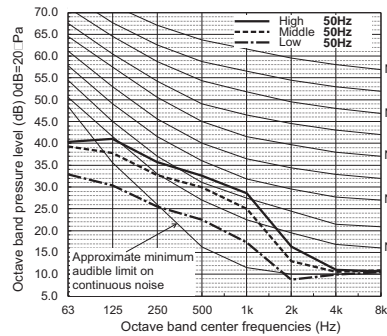

**PEFY-M50VMA(L)-A**

External Static Pressure: 50Pa [0.20in.WG]  
Power Source: 220-240V

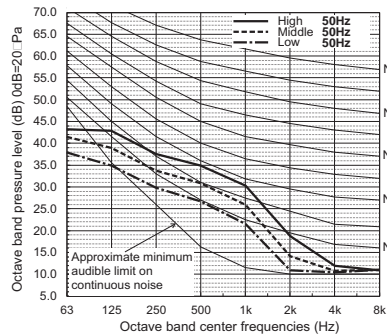

**PEFY-M50VMA(L)-A**

External Static Pressure: 70Pa [0.28in.WG]  
Power Source: 220-240V

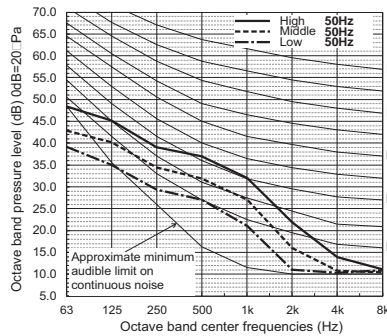

**PEFY-M50VMA(L)-A**

External Static Pressure: 100Pa [0.40in.WG]  
Power Source: 220-240V

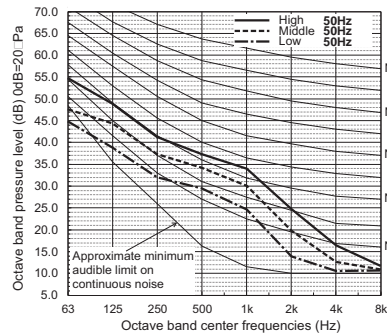

**PEFY-M50VMA(L)-A**

External Static Pressure: 150Pa [0.60in.WG]  
Power Source: 220-240V

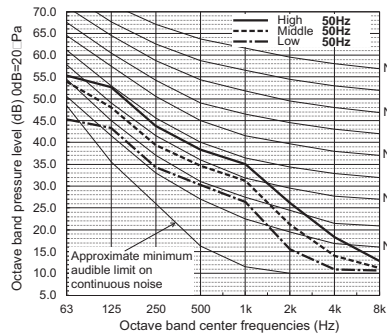

**PEFY-M63VMA(L)-A**

External Static Pressure: 35Pa [0.14in.WG]  
Power Source: 220-240V

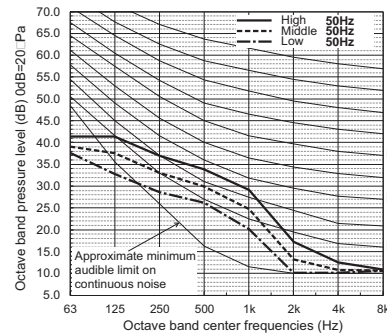

**PEFY-M63VMA(L)-A**

External Static Pressure: 50Pa [0.20in.WG]  
Power Source: 220-240V

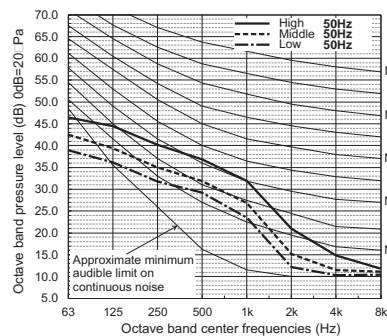

**PEFY-M63VMA(L)-A**

External Static Pressure: 70Pa [0.28in.WG]  
Power Source: 220-240V

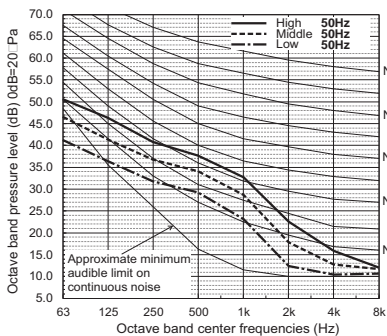

**PEFY-M63VMA(L)-A**

External Static Pressure: 100Pa [0.40in.WG]  
Power Source: 220-240V

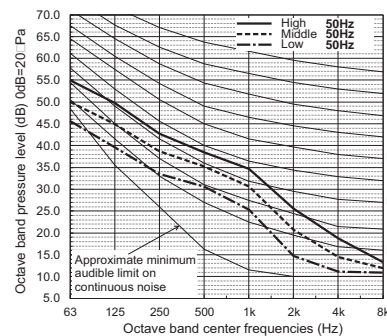

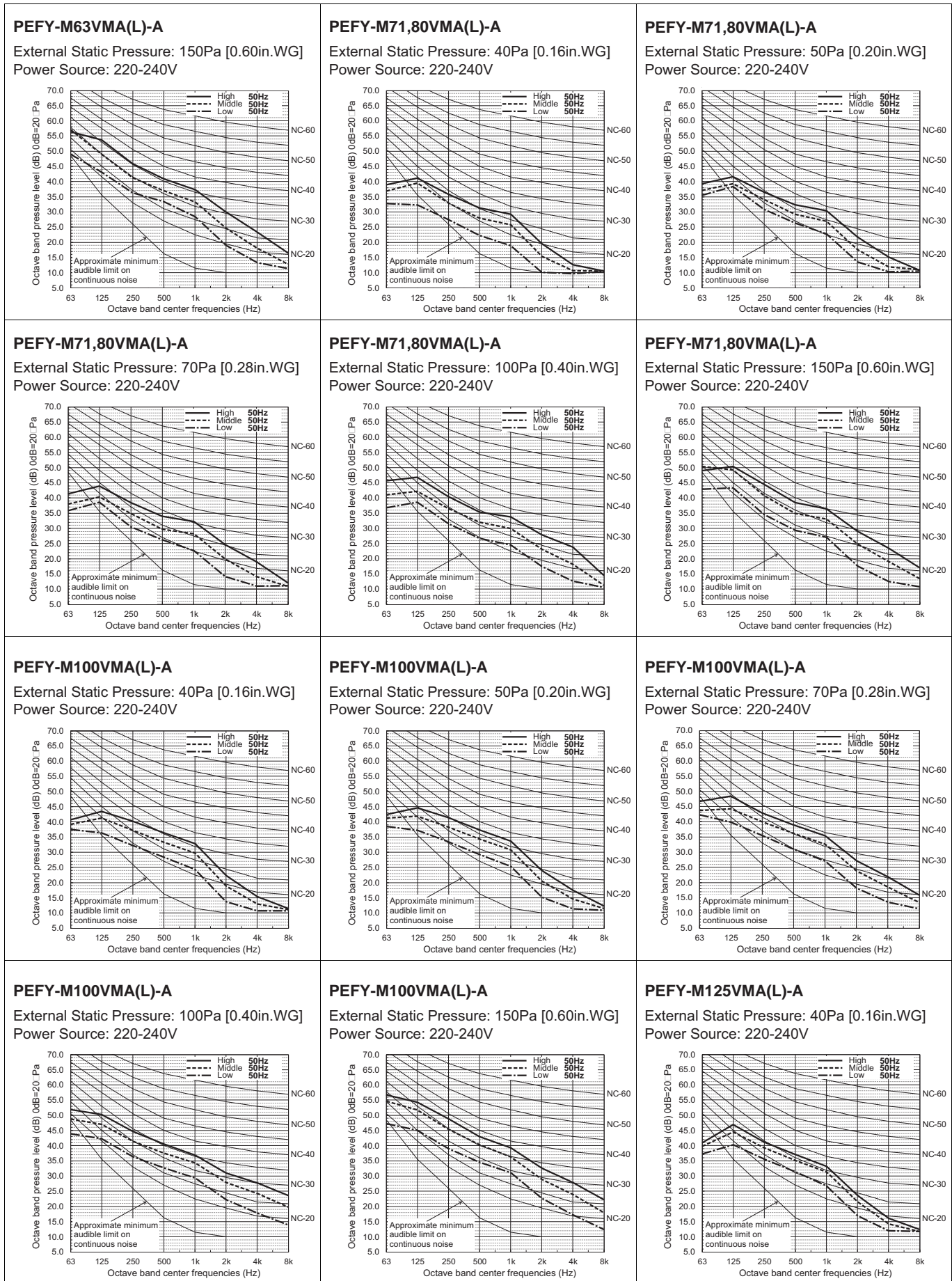

PEFY-M-VMA(L)-A

**PEFY-M125VMA(L)-A**

External Static Pressure: 50Pa [0.20in.WG]  
Power Source: 220-240V

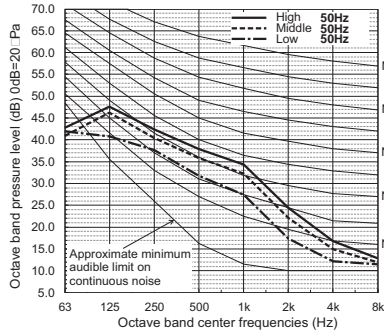

**PEFY-M125VMA(L)-A**

External Static Pressure: 70Pa [0.28in.WG]  
Power Source: 220-240V

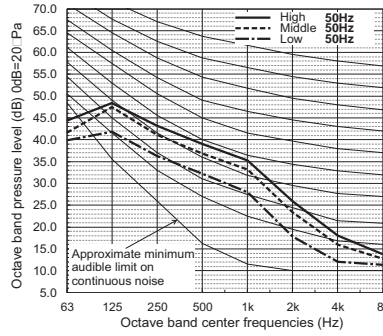

**PEFY-M125VMA(L)-A**

External Static Pressure: 100Pa [0.40in.WG]  
Power Source: 220-240V

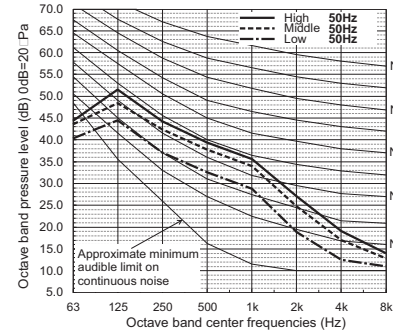

**PEFY-M125VMA(L)-A**

External Static Pressure: 150Pa [0.60in.WG]  
Power Source: 220-240V

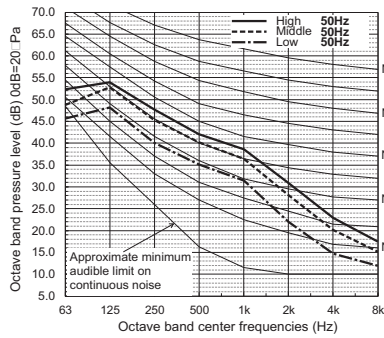

**PEFY-M140VMA(L)-A**

External Static Pressure: 40Pa [0.16in.WG]  
Power Source: 220-240V

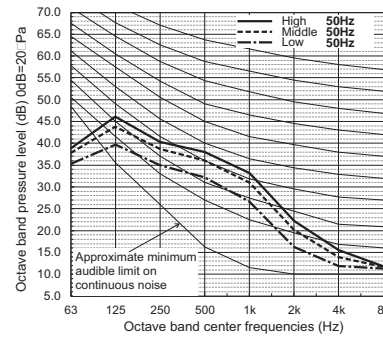

**PEFY-M140VMA(L)-A**

External Static Pressure: 50Pa [0.20in.WG]  
Power Source: 220-240V

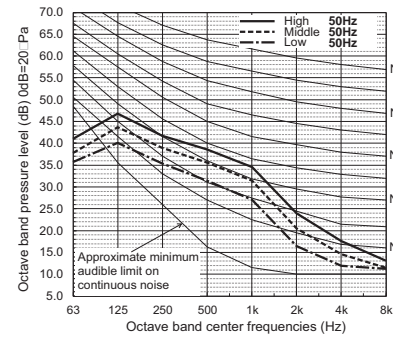

**PEFY-M140VMA(L)-A**

External Static Pressure: 70Pa [0.28in.WG]  
Power Source: 220-240V

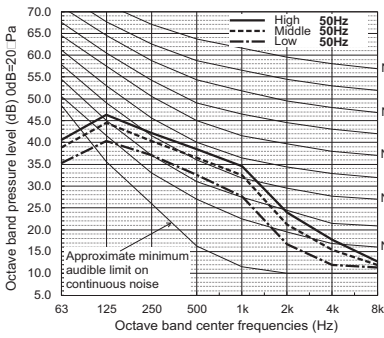

**PEFY-M140VMA(L)-A**

External Static Pressure: 100Pa [0.40in.WG]  
Power Source: 220-240V

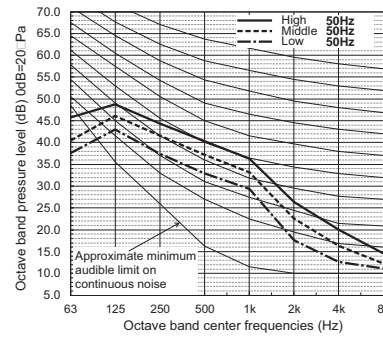

**PEFY-M140VMA(L)-A**

External Static Pressure: 150Pa [0.60in.WG]  
Power Source: 220-240V

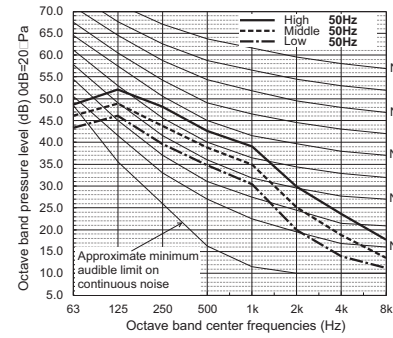

## 6. FAN CHARACTERISTICS CURVES

Ceiling concealed (Medium static pressure type)

PEFY-M-VMA(L)-A

### PEFY-M20, 25VMA(L)-A

External static pressure : 35Pa  
Power source : 220-240V

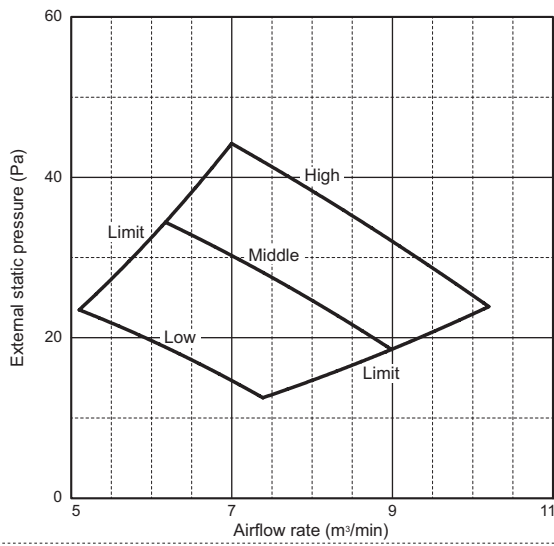

### PEFY-M20, 25VMA(L)-A

External static pressure : 50Pa  
Power source : 220-240V

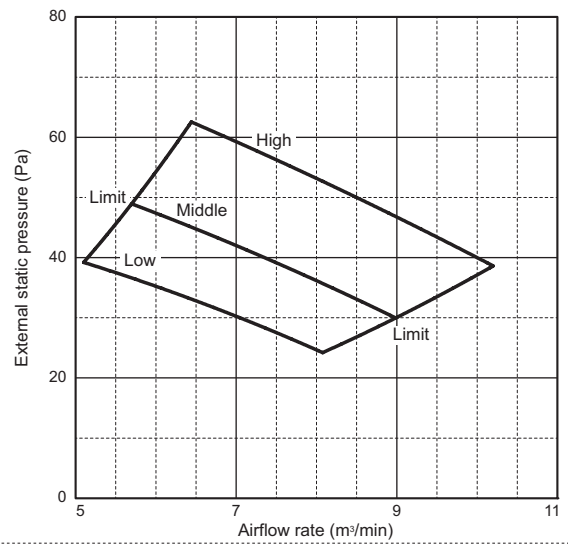

### PEFY-M20, 25VMA(L)-A

External static pressure : 70Pa  
Power source : 220-240V

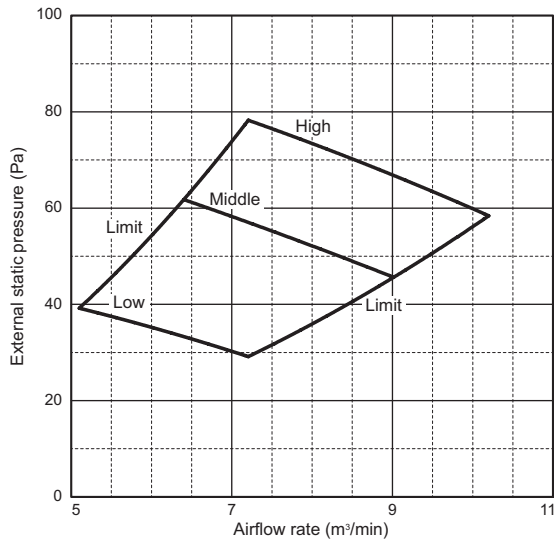

### PEFY-M20, 25VMA(L)-A

External static pressure : 100Pa  
Power source : 220-240V

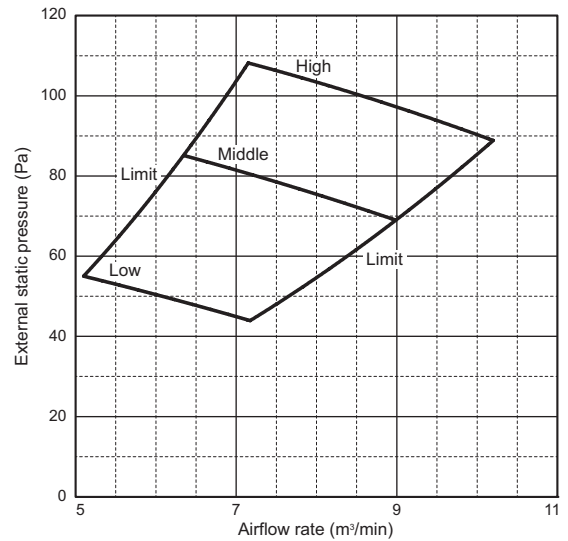

### PEFY-M20, 25VMA(L)-A

External static pressure : 150Pa  
Power source : 220-240V

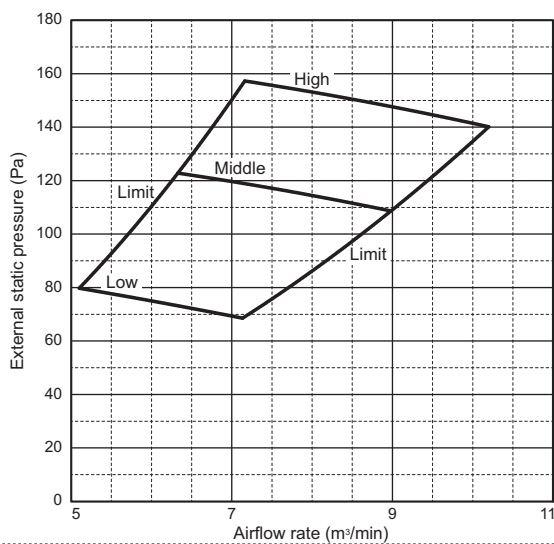



## 6. FAN CHARACTERISTICS CURVES

Ceiling concealed (Medium static pressure type)

PEFY-M-VMA(L)-A

### PEFY-M32VMA(L)-A

External static pressure : 35Pa  
Power source : 220-240V

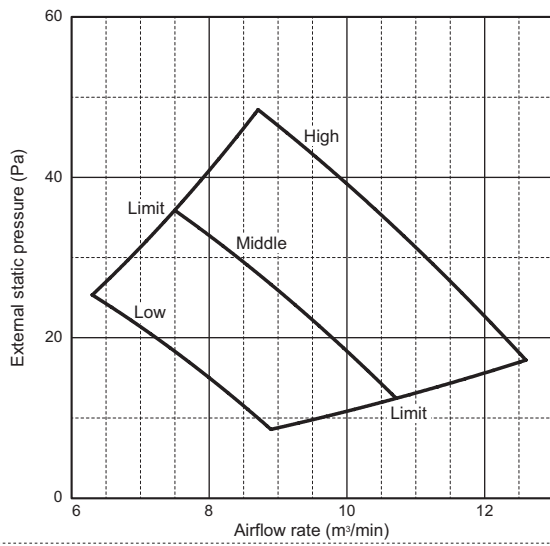

### PEFY-M32VMA(L)-A

External static pressure : 50Pa  
Power source : 220-240V

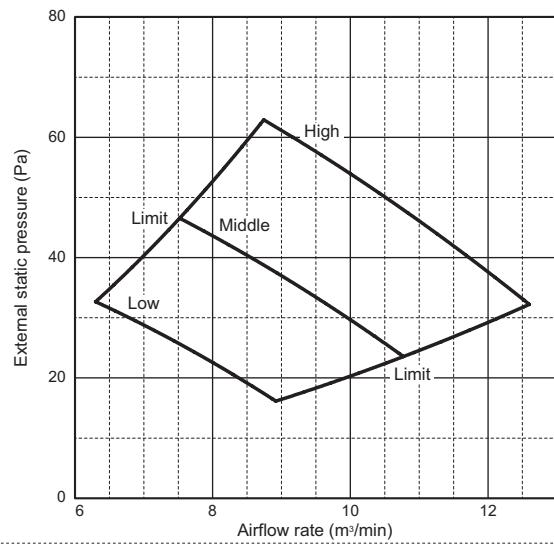

### PEFY-M32VMA(L)-A

External static pressure : 70Pa  
Power source : 220-240V

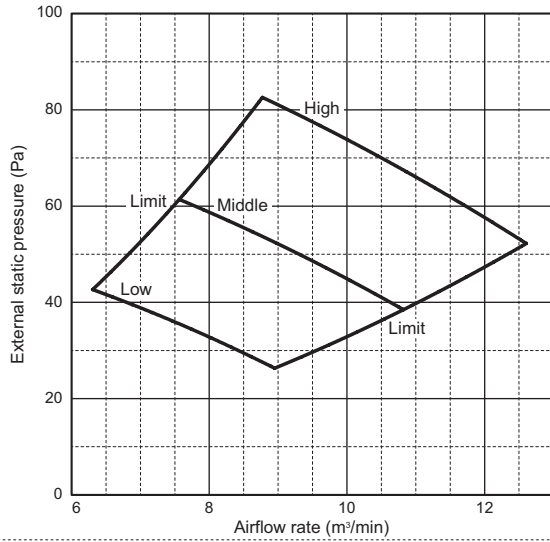

### PEFY-M32VMA(L)-A

External static pressure : 100Pa  
Power source : 220-240V

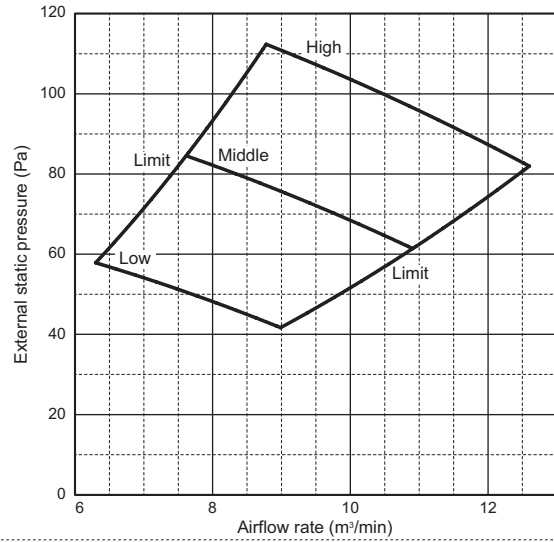

### PEFY-M32VMA(L)-A

External static pressure : 150Pa  
Power source : 220-240V

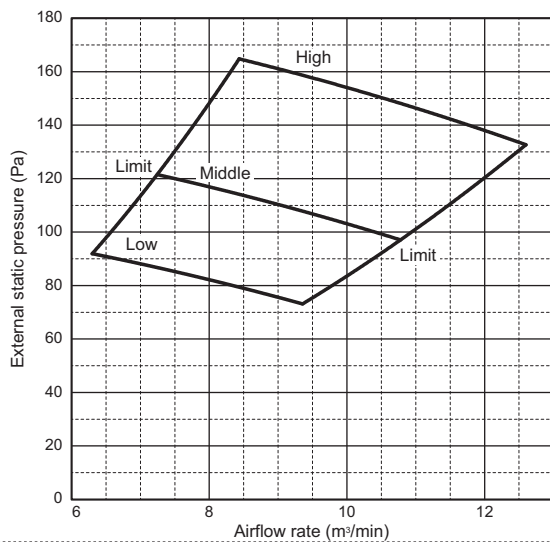

## 6. FAN CHARACTERISTICS CURVES

Ceiling concealed (Medium static pressure type)

PEFY-M-VMA(L)-A

### PEFY-M40VMA(L)-A

External static pressure : 35Pa  
Power source : 220-240V

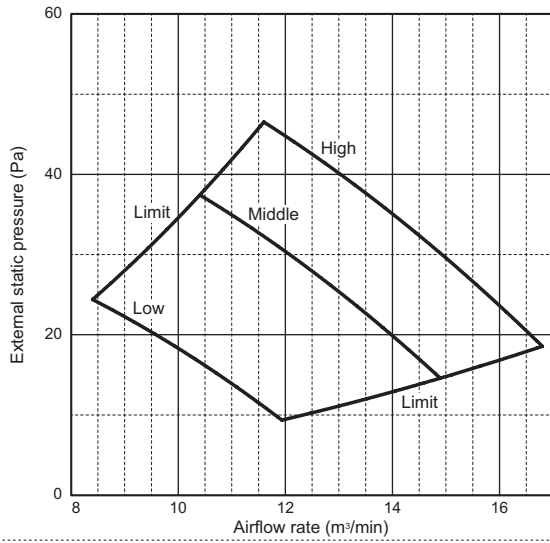

### PEFY-M40VMA(L)-A

External static pressure : 50Pa  
Power source : 220-240V

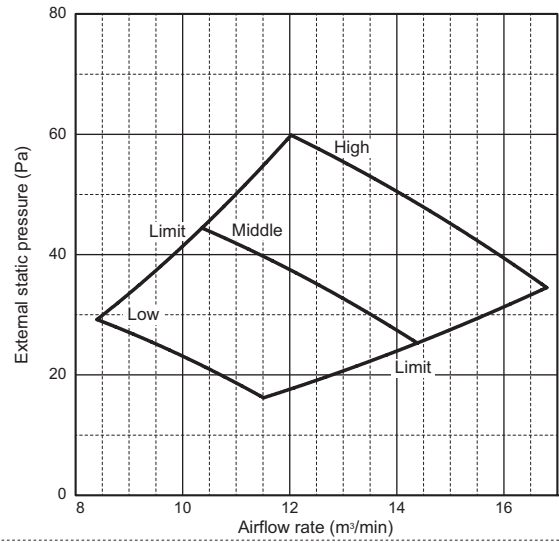

### PEFY-M40VMA(L)-A

External static pressure : 70Pa  
Power source : 220-240V

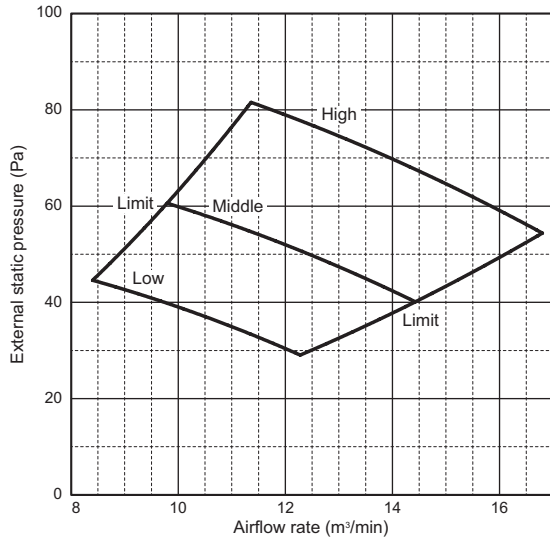

### PEFY-M40VMA(L)-A

External static pressure : 100Pa  
Power source : 220-240V

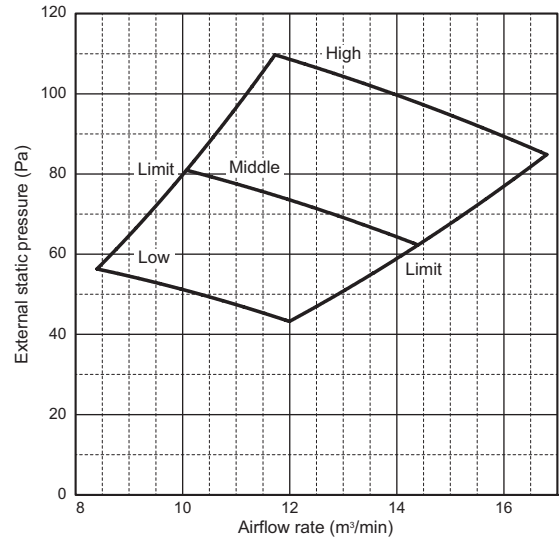

### PEFY-M40VMA(L)-A

External static pressure : 150Pa  
Power source : 220-240V

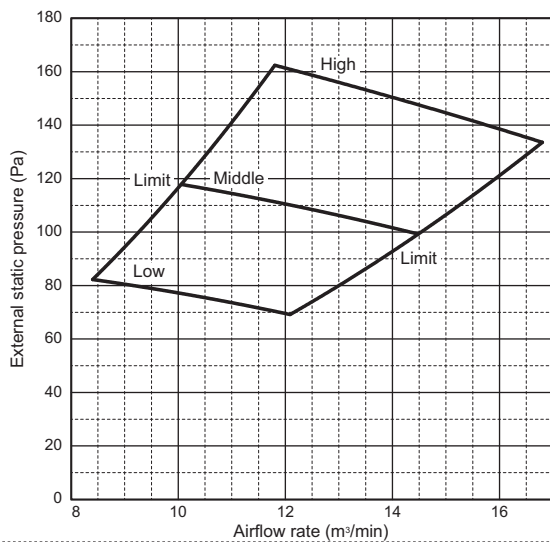

## 6. FAN CHARACTERISTICS CURVES

Ceiling concealed (Medium static pressure type)

PEFY-M-VMA(L)-A

### PEFY-M50VMA(L)-A

External static pressure : 35Pa  
Power source : 220-240V

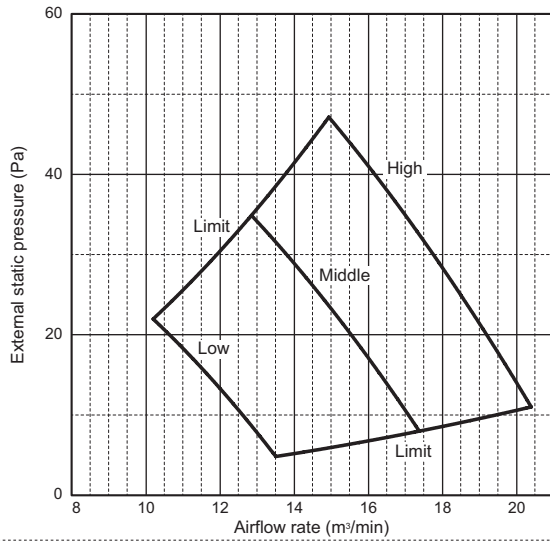

### PEFY-M50VMA(L)-A

External static pressure : 50Pa  
Power source : 220-240V

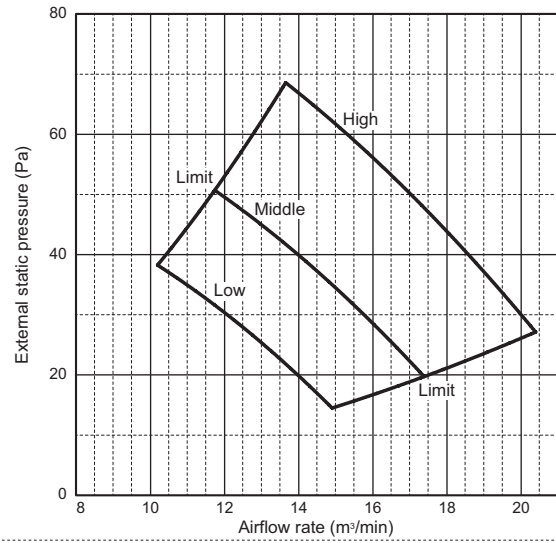

### PEFY-M50VMA(L)-A

External static pressure : 70Pa  
Power source : 220-240V

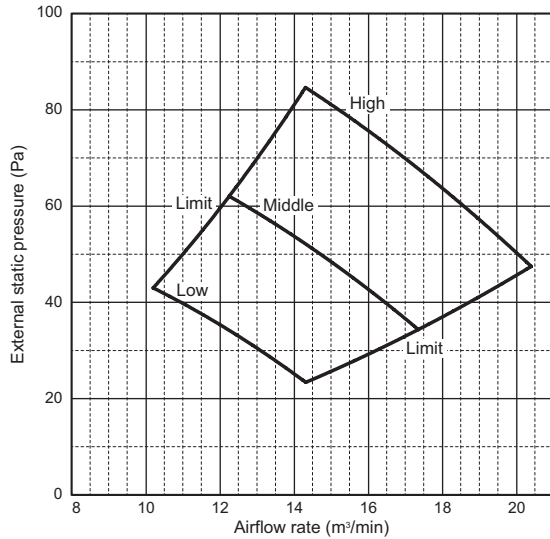

### PEFY-M50VMA(L)-A

External static pressure : 100Pa  
Power source : 220-240V

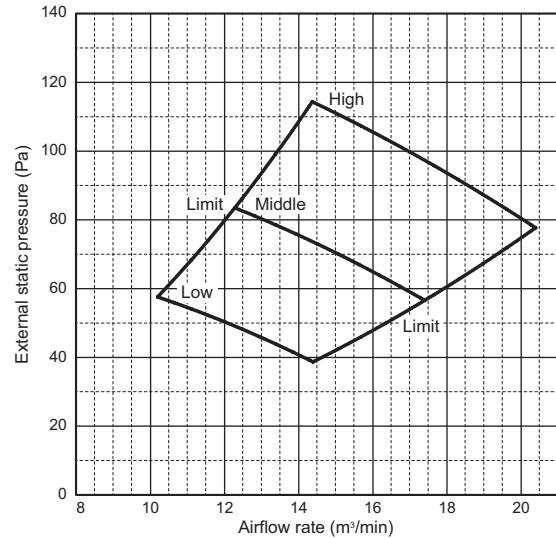

### PEFY-M50VMA(L)-A

External static pressure : 150Pa  
Power source : 220-240V

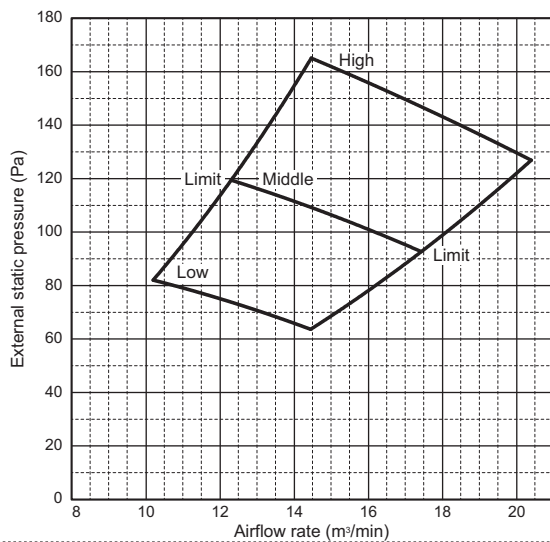

**PEFY-M63VMA(L)-A**

External static pressure : 35Pa  
Power source : 220-240V

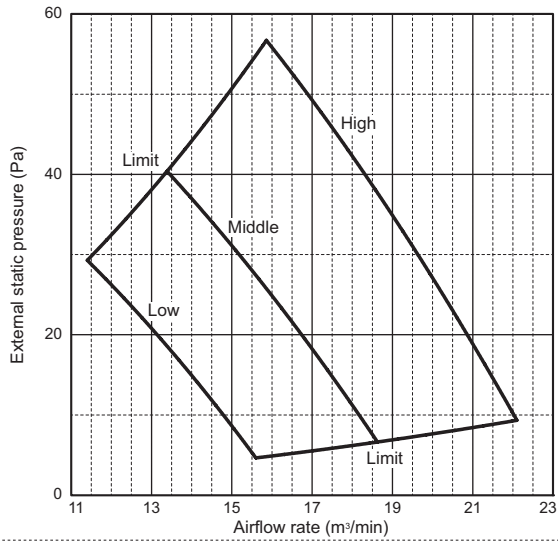

**PEFY-M63VMA(L)-A**

External static pressure : 50Pa  
Power source : 220-240V

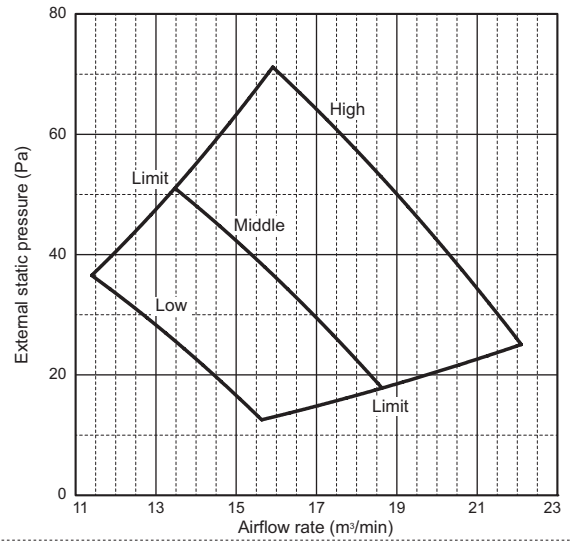

**PEFY-M63VMA(L)-A**

External static pressure : 70Pa  
Power source : 220-240V

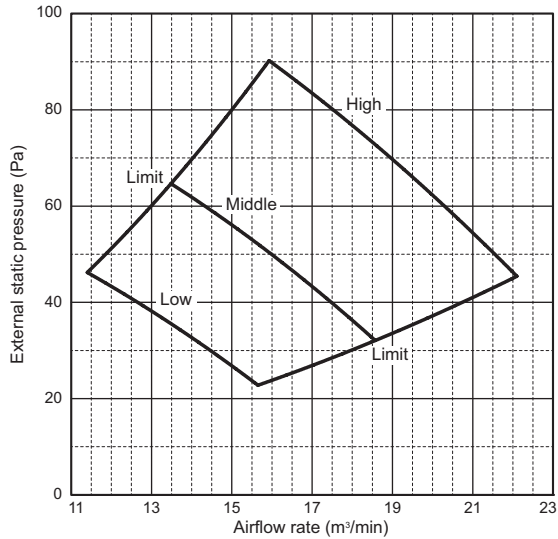

**PEFY-M63VMA(L)-A**

External static pressure : 100Pa  
Power source : 220-240V

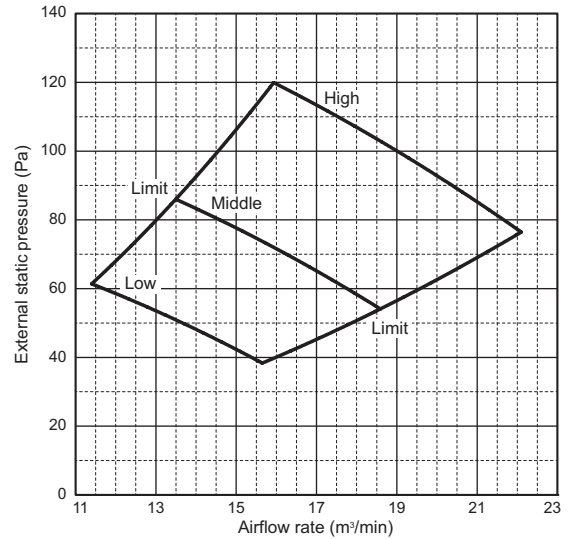

**PEFY-M63VMA(L)-A**

External static pressure : 150Pa  
Power source : 220-240V

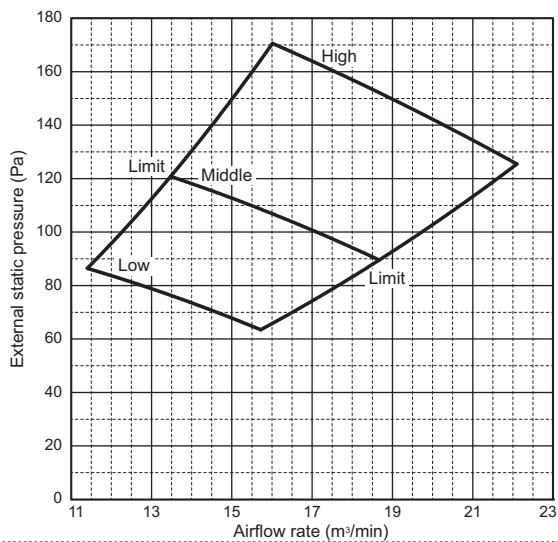

## 6. FAN CHARACTERISTICS CURVES

Ceiling concealed (Medium static pressure type)

PEFY-M-VMA(L)-A

### PEFY-M71, 80VMA(L)-A

External static pressure : 40Pa

Power source : 220-240V

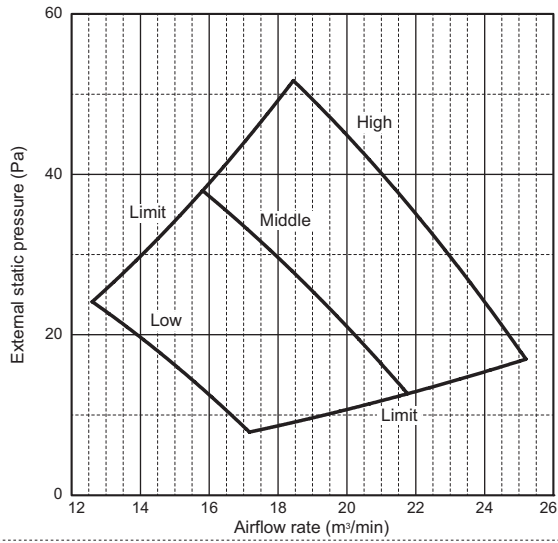

### PEFY-M71, 80VMA(L)-A

External static pressure : 50Pa

Power source : 220-240V

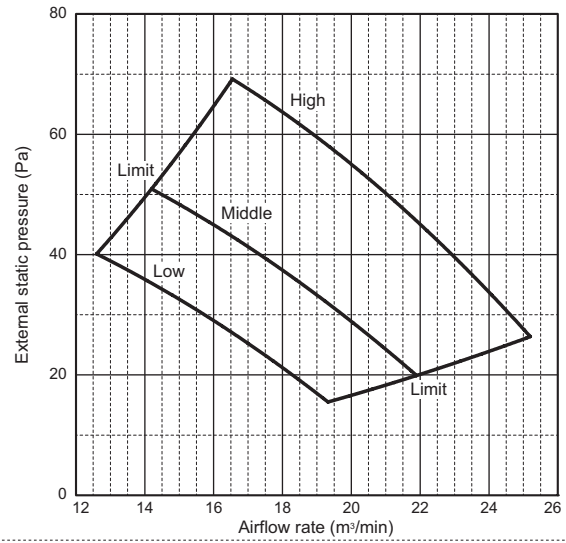

### PEFY-M71, 80VMA(L)-A

External static pressure : 70Pa

Power source : 220-240V

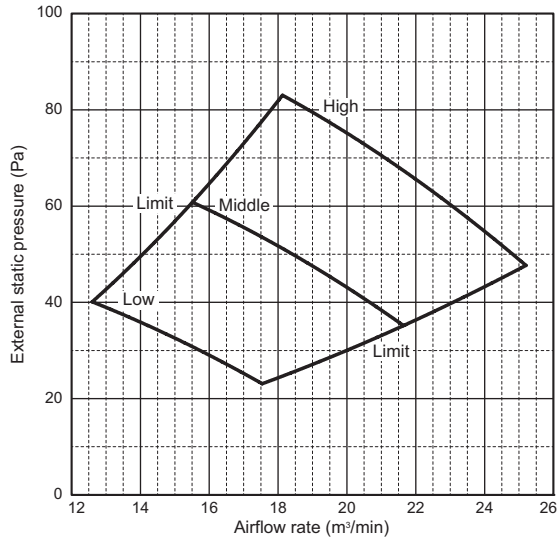

### PEFY-M71, 80VMA(L)-A

External static pressure : 100Pa

Power source : 220-240V

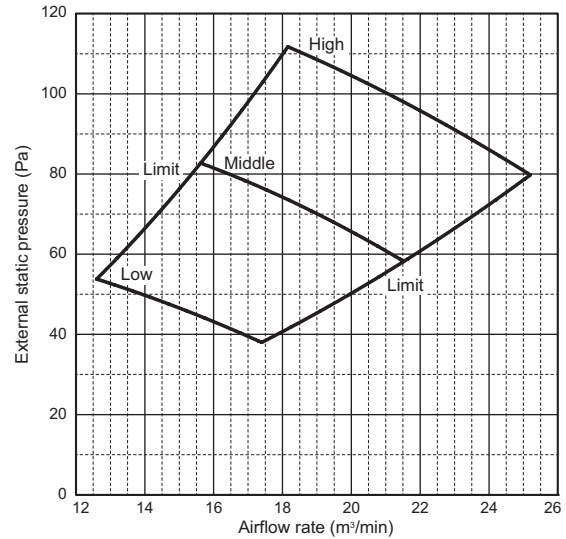

### PEFY-M71, 80VMA(L)-A

External static pressure : 150Pa

Power source : 220-240V

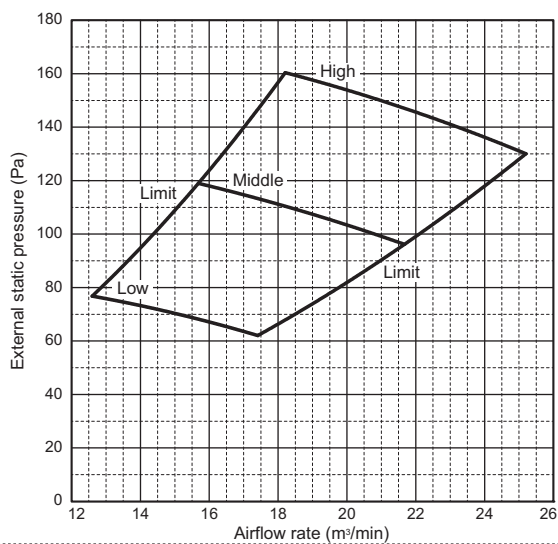

**PEFY-M100VMA(L)-A**

External static pressure : 40Pa  
Power source : 220-240V

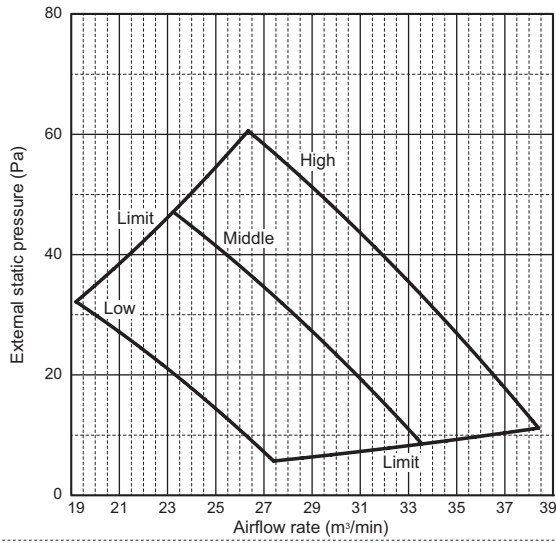

**PEFY-M100VMA(L)-A**

External static pressure : 50Pa  
Power source : 220-240V

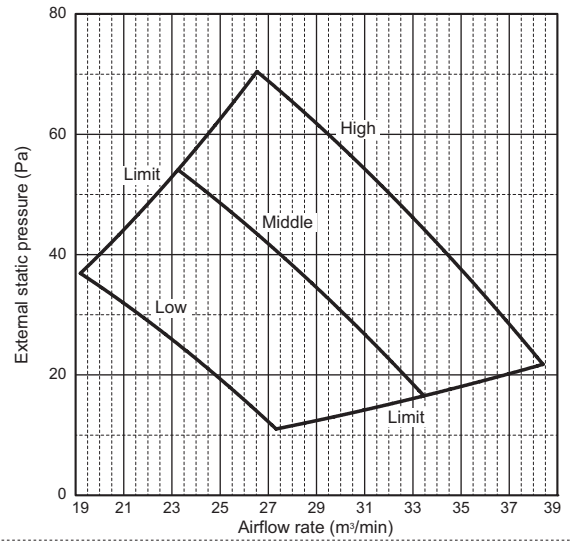

**PEFY-M100VMA(L)-A**

External static pressure : 70Pa  
Power source : 220-240V

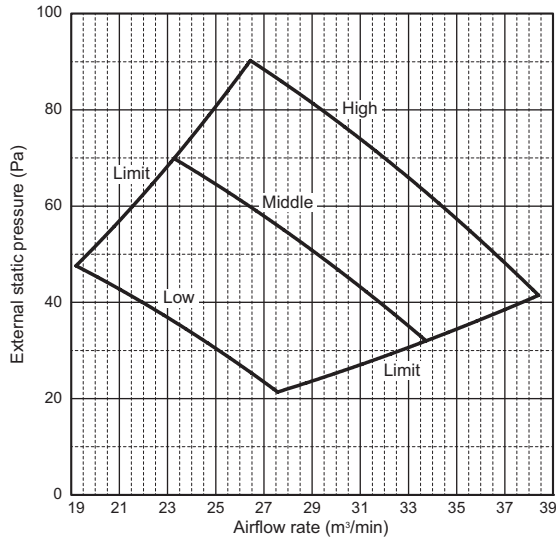

**PEFY-M100VMA(L)-A**

External static pressure : 100Pa  
Power source : 220-240V

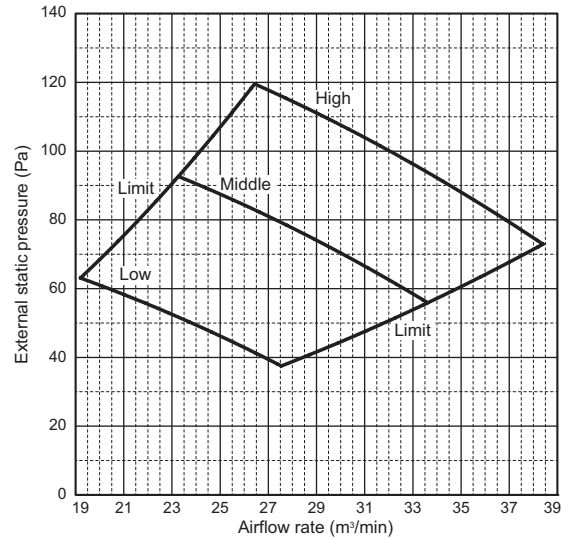

**PEFY-M100VMA(L)-A**

External static pressure : 150Pa  
Power source : 220-240V

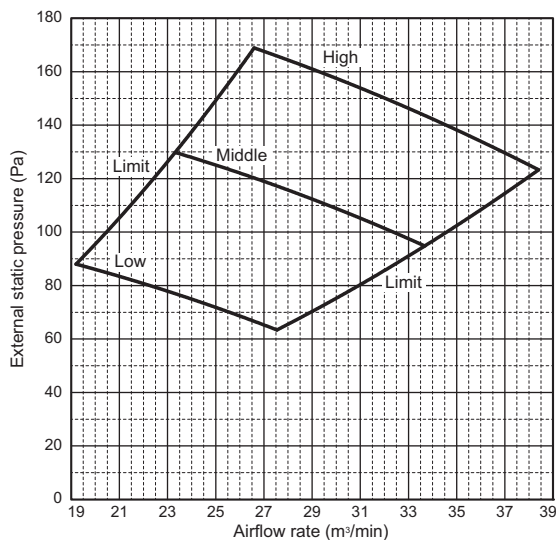

## 6. FAN CHARACTERISTICS CURVES

Ceiling concealed (Medium static pressure type)

PEFY-M-VMA(L)-A

**PEFY-M125VMA(L)-A**  
External static pressure : 40Pa  
Power source : 220-240V

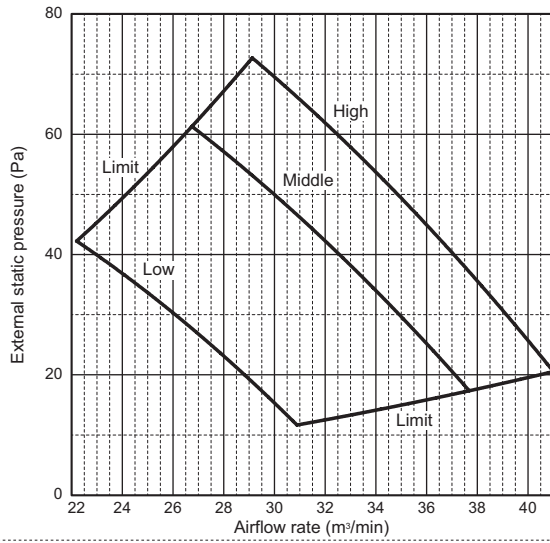

**PEFY-M125VMA(L)-A**  
External static pressure : 50Pa  
Power source : 220-240V

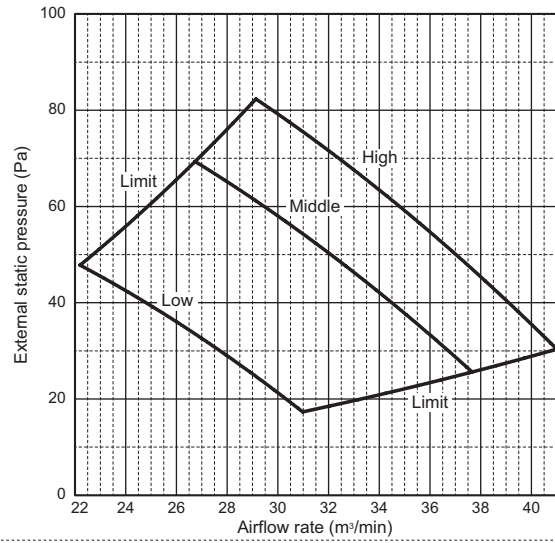

**PEFY-M125VMA(L)-A**  
External static pressure : 70Pa  
Power source : 220-240V

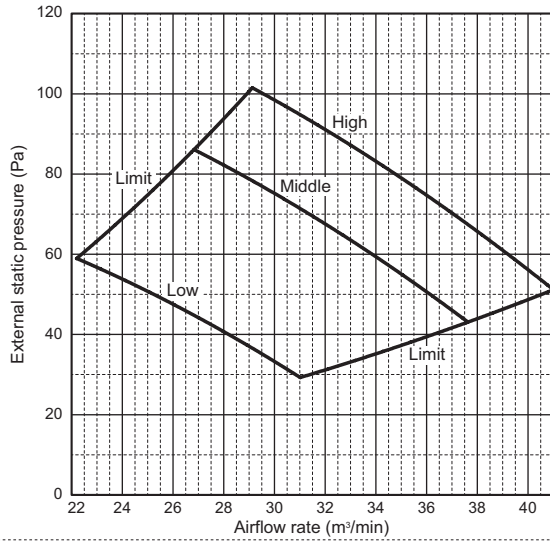

**PEFY-M125VMA(L)-A**  
External static pressure : 100Pa  
Power source : 220-240V

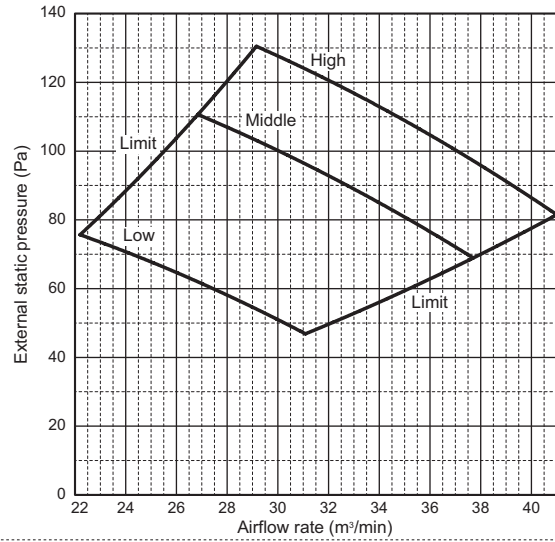

**PEFY-M125VMA(L)-A**  
External static pressure : 150Pa  
Power source : 220-240V

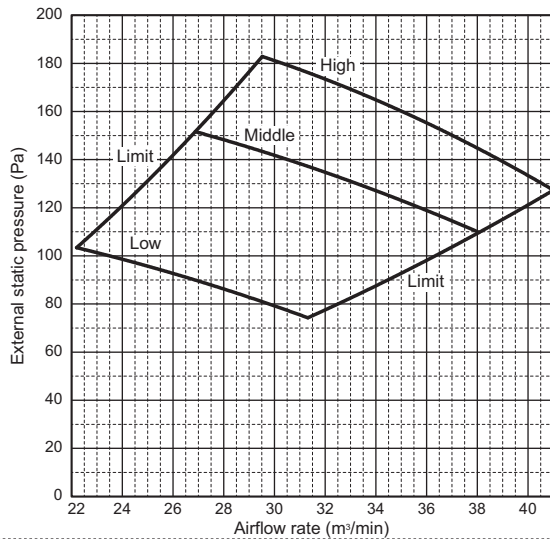

**PEFY-M140VMA(L)-A**

External static pressure : 40Pa  
Power source : 220-240V

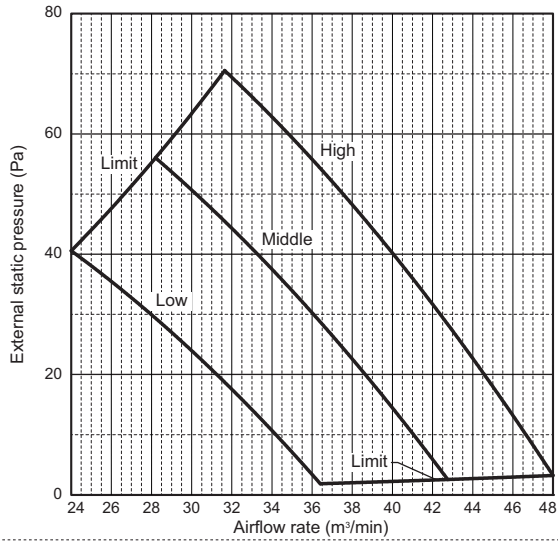

**PEFY-M140VMA(L)-A**

External static pressure : 50Pa  
Power source : 220-240V

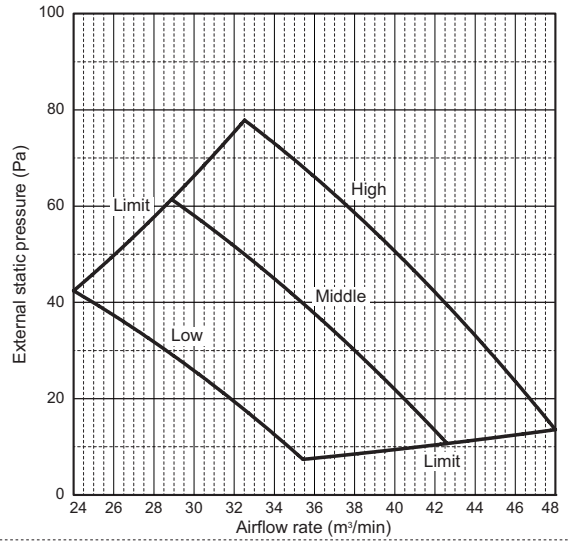

**PEFY-M140VMA(L)-A**

External static pressure : 70Pa  
Power source : 220-240V

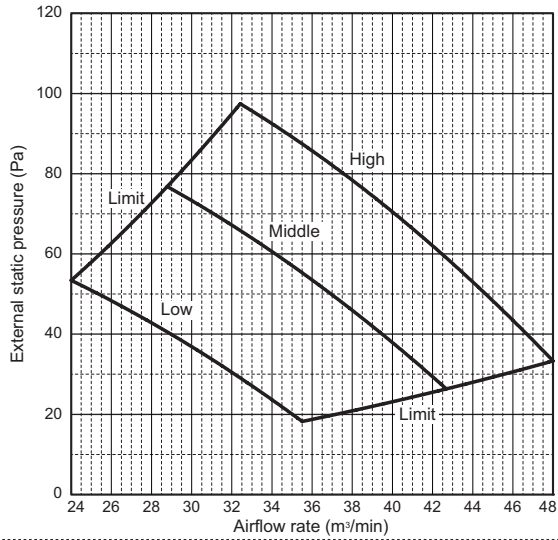

**PEFY-M140VMA(L)-A**

External static pressure : 100Pa  
Power source : 220-240V

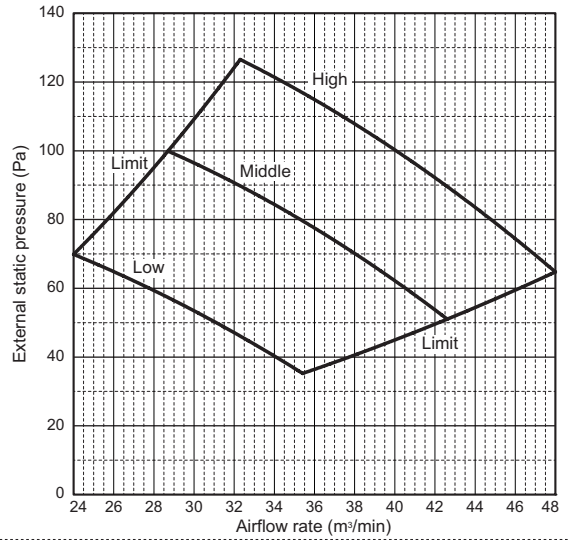

**PEFY-M140VMA(L)-A**

External static pressure : 150Pa  
Power source : 220-240V

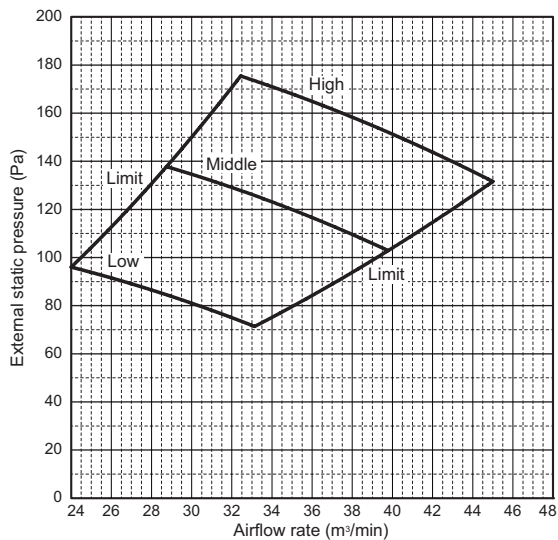



7-1. Correction by fan speed

PEFY-M-VMA(L)-A

Cooling

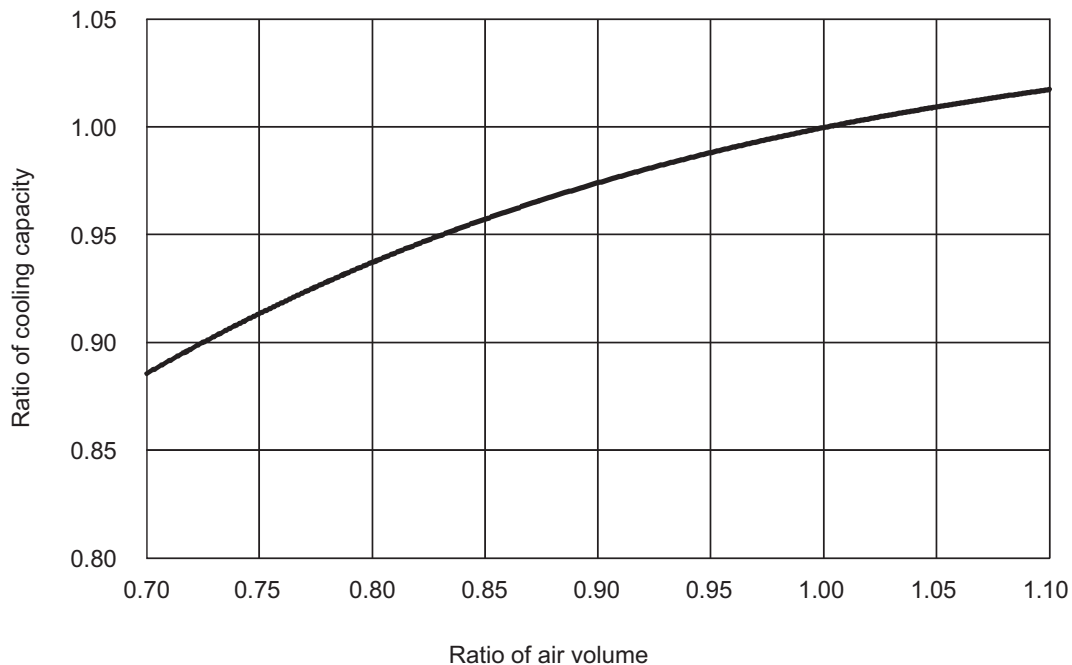

Heating

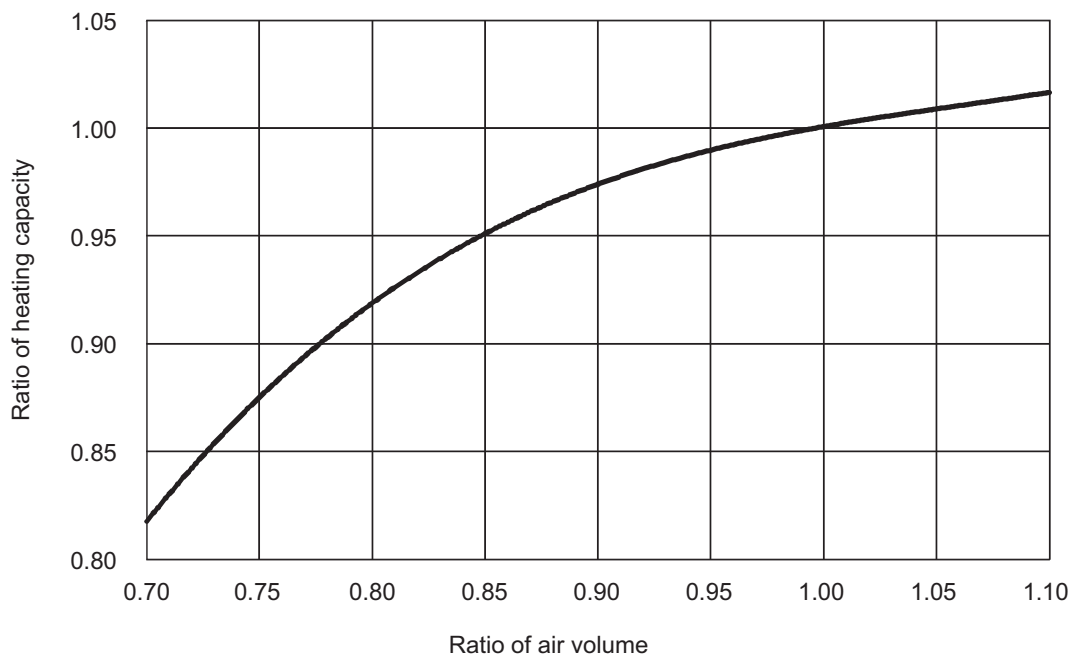

## 8. ELECTRICAL CHARACTERISTICS

Ceiling concealed (Medium static pressure type)

Symbols: MCA (Max.Circuit Amps =1.25xFLA), FLA (Full Load Amps)  
IFM (Indoor Fan Motor), Output (Fan motor rated output)

PEFY-M-VMA(L)-A	Power supply			IFM	
	Volts/Hz	Range +-10%	MCA (A)	Output (kW)	FLA (A)
PEFY-M20VMA(L)-A	220-240V/50Hz 220-240V/60Hz	Max.: 264V Min.: 198V	0.93	0.085	0.74
PEFY-M25VMA(L)-A			0.93	0.085	0.74
PEFY-M32VMA(L)-A			1.19	0.085	0.95
PEFY-M40VMA(L)-A			1.45	0.121	1.16
PEFY-M50VMA(L)-A			1.55	0.121	1.24
PEFY-M63VMA(L)-A			1.69	0.121	1.35
PEFY-M71VMA(L)-A			2.31	0.121	1.85
PEFY-M80VMA(L)-A			2.38	0.121	1.90
PEFY-M100VMA(L)-A			2.81	0.300	2.25
PEFY-M125VMA(L)-A			2.93	0.300	2.34
PEFY-M140VMA(L)-A			3.29	0.300	2.63

PEFY-M-VMA(L)-A

9-1. Optional parts line up for the Indoor unit

PEFY-M-VMA(L)-A

Filter box

PEFY-M20, 25, 32VMA(L)-A  
 PEFY-M40, 50, 63VMA(L)-A  
 PEFY-M71, 80VMA(L)-A  
 PEFY-M100, 125VMA(L)-A  
 PEFY-M140VMA(L)-A

PAC-KE91TB-E  
 PAC-KE92TB-E  
 PAC-KE93TB-E  
 PAC-KE94TB-E  
 PAC-KE95TB-E

● PEFY-M-VMA(L)-A

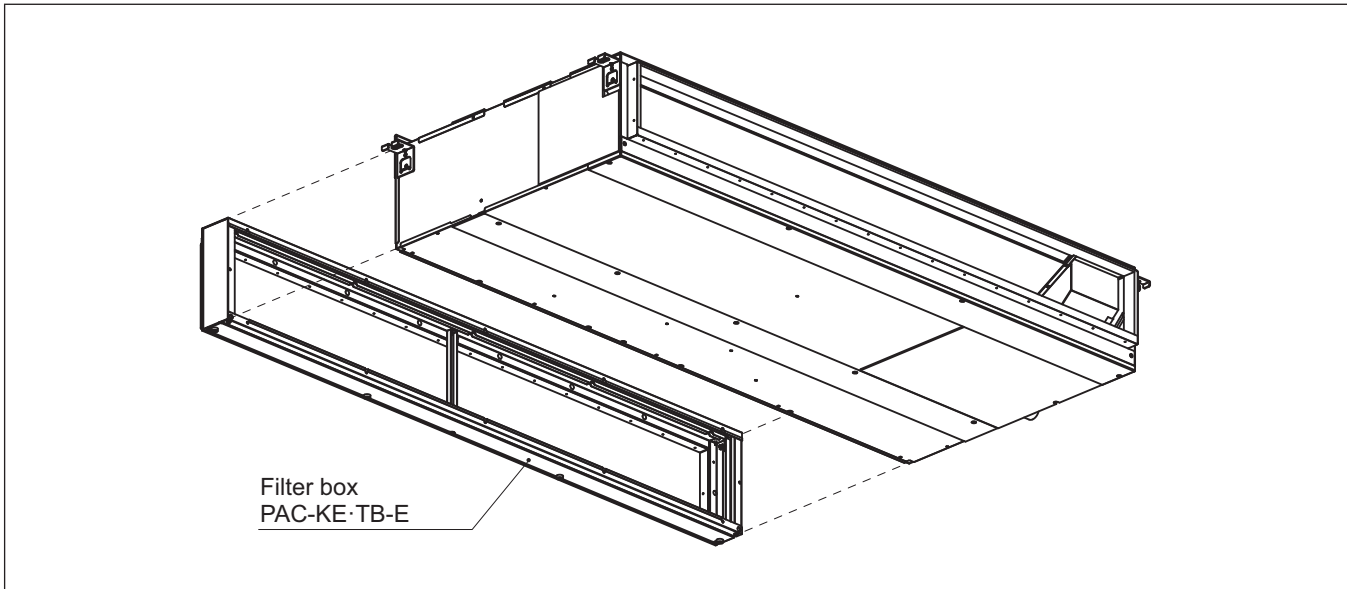

9-2. Filter box

PAC-KE-TB-E

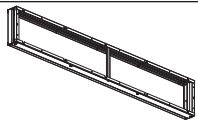
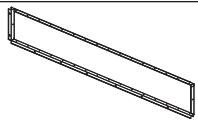
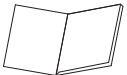
Item	1 Screw	2 Filter box	3 FLANGE	4 Installation manual	
Quantity	30	1	1	1	
Shape					

Detailed installation information should be referred to its Installation Manual.



**for a greener tomorrow**

Eco Changes is the Mitsubishi Electric Group's environmental statement, and expresses the Group's stance on environmental management. Through a wide range of businesses, we are helping contribute to the realization of a sustainable society.

**⚠ Warning**

- Do not use refrigerant other than the type indicated in the manuals provided with the unit and on the nameplate.
  - Doing so may cause the unit or pipes to burst, or result in explosion or fire during use, repair, or at the time of disposal of the unit.
  - It may also be in violation of applicable laws.
  - MITSUBISHI ELECTRIC CORPORATION cannot be held responsible for malfunctions or accidents resulting from the use of the wrong type of refrigerant.
- Our air conditioning equipment and heat pumps contain a fluorinated greenhouse gas, R32 or R410A.

**MITSUBISHI ELECTRIC CORPORATION**

[www.MitsubishiElectric.com](http://www.MitsubishiElectric.com)