

SAMSUNG

SYSTEM AIRCONDITIONER

INDOOR UNIT

AM022/028/036FN1DEH/TK
AM056/071JN1DEH/TK
AM056/071FN2DEH/TK
AM045/056/071/090/112/128/140/FN4DEH/TK
AM022/028/036/045/056/060FNNDDEH/TK
AM112/128/140/220/280FNHDEH/TK
AM036/056/071FNFDEH/TK
AM050/100FNKDEH/TK
AM017/022/028/036/045/056/071/090/112/128/140FNLDEH/TK
AM022/028/036/045/056/071/090/112//128/140FNMDEH/TK
AM056/071FNCDEH/TK
AM028/036/056FNJDEH/TK
AM022/028/036/056/071FNTDEH/TK
AM022/028/036/045/056/071FNQDEH/TK
AM160KNMDEH/TK
AM022/045KNJDEH/TK
AM015/022/028/036/045/056/071/082JNVDEH/TK
AM180/228JNHPKH/TK
AM045/056/071/090/112/128/140KN4DEH/TK

SERVICE *Manual*

SYSTEM AIRCONDITIONER



CONTENTS

1. Precautions
2. Product Specifications
3. Disassembly and Reassembly
4. Troubleshooting
5. PCB Diagram and Parts List
6. Wiring Diagram
7. Reference Sheet

Refer to the service manual in the GSPN(see the rear cover) for the more information.

Contents

1. Precautions	1-1
1-1 Precautions for the Service	1-1
1-2 Precautions for the Static Electricity and PL	1-1
1-3 Precautions for the Safety	1-1
1-4 Precautions for Handling Refrigerant for Air Conditioner.....	1-2
1-5 Precautions for Welding the Air Conditioner Pipe.....	1-2
1-6 Precautions for Additional Supplement of Air Conditioner Refrigerant.....	1-2
1-7 Other Precautions	1-2
2. Product Specifications	2-1
2-1 Product Specifications	2-1
2-1-1 Indoor Unit	2-1
2-2 Accessory and Option Specifications	2-27
2-2-1 Accessories	2-27
3. Disassembly and Reassembly	3-1
3-1 Indoor Unit	3-2
■ Slim 1 way cassette type (medium)	3-2
■ Slim 1 way cassette type (large)	3-11
■ BIG DUCT	3-18
■ Global 4way Cassette type	3-21
■ 360 Cassette	3-27
■ Duct type(Slim1,2).....	3-36
■ Duct type(Slim3).....	3-41
■ Duct type(Mid pressure1)	3-48
■ Duct typeDuct type (Mid Pressure2, High Pressure)	3-53
■ CEILING.....	3-58
■ CONSOLE	3-67
■ ERV PLUS.....	3-72
■ Floor Standin Type.....	3-81
■ Wall Mounted type(Neo Forte without EEV).....	3-85
■ Wall Mounted type(A3050 With EEV)	3-88
■ Global Mini 4way	3-97
■ GD-S(Big Duct).....	3-103
4. Troubleshooting.....	4-1
4-1 Check-up Window Description.....	4-1
4-2 Service Operation.....	4-2
4-3 Troubleshooting.....	4-7
4-4 Appropriate Measures for Different Symptom.....	4-46

Contents

5. PCB Diagram and Parts List	5-1
5-1 Indoor Unit	5-1
5-1-1 Slim 1 way cassette type	5-1
5-1-2 2 way cassette type	5-3
5-1-3 4way cassette , mini 4way cassette type, Slim 1 way cassette type (large).....	5-5
5-1-4 360 cassette.....	5-7
5-1-5 Indoor Unit Power PCB.....	5-9
5-1-6 Display PCB.....	5-10
5-1-7 Duct type (Slim Duct 2).....	5-11
5-1-8 Duct type (Slim Duct 3).....	5-14
5-1-9 Duct type(MSP, HSP, Big Duct)	5-17
5-1-10 Duct type(HSP).....	5-19
5-1-11 Duct type (Super).....	5-21
5-1-12 Ceiling type.....	5-23
5-1-13 Console	5-25
5-1-14 Wall-Mounted type (Neo Forte)	5-29
5-1-15 Wall Mounted type(A3050).....	5-31
5-1-16 ERV Plus	5-34
5-1-17 GD-S (Big Duct)	5-36
6. Wiring Diagram	6-1
6-1 Indoor	6-1
6-1-1 Global 4way(Global Mini-4way) cassette type, Slim 1 way cassette (large).....	6-1
6-1-2 Slim 1 way cassette type (medium).....	6-2
6-1-3 360 cassette.....	6-3
6-1-4 BIG Duct	6-4
6-1-5 Ceiling.....	6-5
6-1-6 Console.....	6-6
6-1-7 Wall Mounted type(Neo Forte without EEV)	6-7
6-1-8 Wall Mounted type(A3050)	6-8
6-1-9 2way cassette type	6-9
6-1-10 DUCT type (Slim III).....	6-10
6-1-11 DUCT type (Slim I, II, MSP).....	6-11
6-1-12 Duct type (HSP).....	6-12
6-1-13 Floor Stand Type.....	6-13
6-1-14 ERV Plus	6-14
6-1-15 GD-S (Big Duct)	6-15
7. Reference Sheet	7-1
7-1 Index for Model Name.....	7-1
7-1-1 Indoor Unit	7-1
7-1-2 Panel.....	7-2
7-2 Pump-down Method.....	7-3
7-2-1 Precautions for Pump-down	7-3
7-2-2 For Single Installation of Outdoor Unit (Only One Outdoor Unit Installed)	7-3
7-2-3 When Two or More Outdoor Units are Installed	7-3
7-3 How to Put Refrigerant in Refrigerant Container	7-4
7-3-1 How to put refrigerant in container before pump-down.....	7-4

1. Precautions

1-1 Precautions for the Service

- **Use the correct parts when changing the electric parts.**
 - Please check the labels and notices for the model name, proper voltage, and proper current for the electric parts.
- **Fully repair the connection for the types of harness when repairing the product after breakdown.**
 - A faulty connection can cause irregular noise and problems.
- **When disassembling or assembling, make sure that the product is laid down on a work cloth.**
 - Doing so will prevent scratching to the exterior of the rear side of the product.
- **Completely remove dust or foreign substances on the housing, connection, and inspection parts when performing repairs.**
 - This can prevent fire hazards for tracking, short, etc.
- **Please tighten the service valve of the outdoor unit and the valve cap of the charging valve as securely as possible by using a monkey spanner.**
- **Check whether the parts are properly and securely assembled after performing repairs.**
 - These parts should be in the same condition as before the repair.

1-2 Precautions for the Static Electricity and PL

- **Please carefully handle the PCB power terminal during repair and measurement when it is turned on since it is vulnerable to static electricity.**
 - Please wear insulation gloves before performing PCB repair and measurement.
- **Check if the place of installation is at least 2m away from electronic appliances such as TV, video players, and stereos.**
 - This can cause irregular noise or degrade the picture quality.
- **Please make sure the customer does not directly repair the product.**
 - Arbitrary dismantling may result in electric shock or fire.

1-3 Precautions for the Safety

- **Do not pull or touch the power plug or the subsidiary power switch with wet hands.**
 - This may result in electric shock or fire.
- **If the power line or the power plug is damaged, then it must be changed since this is a hazard.**
- **Do not bend the wire too much or position it so that it can be damaged by a heavy object on top.**
 - This may result in electric shock or fire.
- **The use of multiple electric outlets should be prohibited.**
 - This may result in electric shock or fire.
- **Ground the connection if it is necessary.**
 - The connection must be grounded if there is any risk of electrical short due to water or moisture.
- **Unplug the power or turn off the subsidiary power switch when changing or repairing electrical parts.**
 - Doing so will prevent electric shock.
- **Explain to workers that the battery for the remote control needs to be separated for storage purposes when the product will not be used for a long time.**
 - This can cause a problem for the remote control since battery fluid may trickle out.

1-4 Precautions for Handling Refrigerant for Air Conditioner

Environmental Cautions: Air pollution due to gas release

- **Safety Cautions**

If liquid gas is released, then body parts that come into contact with it may experience frostbite/blister/numbness.

If a large amount of gas is released, then suffocation may occur due to lack of oxygen. If the released gas is heated, then noxious gas may be produced by combustion.

- **Container Handling Cautions**

Do not subject container to physical shock or overheating. (Flowage is possible while moving within the regulated pressure.)

1-5 Precautions for Welding the Air Conditioner Pipe

- **Dangerous or flammable objects around the pipe must be removed before the welding.**

- **If the refrigerant is kept inside the product or the pipe, then remove the refrigerant prior to welding.**

If the welding is carried out while the refrigerant is kept inside, the welding cannot be properly performed. This will also produce noxious gas that is a health hazard. This leakage will also explode with the refrigerant and oil due to an increase in the refrigerant pressure, posing a danger to workers.

- **Please remove the oxide produced inside the pipe during the welding with nitrogen gas.**

Using another gas may cause harm to the product or others.

1-6 Precautions for Additional Supplement of Air Conditioner Refrigerant

- **Precisely calculate the refrigerant by using a scale and S-net, and proceed with the test operation.**

Excessive supplement can cause harm to the product since it can cause an inflow of the liquid refrigerant into the compressor.

- **Do not heat the refrigerant container for a forced injection.**

This may cause harm to the product or others since the refrigerant container may burst.

- **Do not operate the product after removing the product safety pressure switch and sensor.**

If the product is blocked inside, then this may cause harm to the product or others due to the excess pressure increase of the refrigerant gas.

1-7 Other Precautions

- **There should be no leakage of the pipes after installation. When withdrawing the refrigerant, the compressor should be stopped before removing the connecting pipe.**

If the compressor is operating while the refrigerant pipe is not correctly connected and the service valve is opened, then air and other substances can enter the pipe. The interior of the refrigerant cycle may then build up excessive high pressure resulting in explosion and damage.

2. Product Specifications

2-1 Product Specifications

2-1-1 Indoor Unit

■ Slim 1way cassette type

Model			AM022FN1DEH/TK	AM028FN1DEH/TK	AM036FN1DEH/TK	
Power Supply		ø/V/Hz	1/220~240/50	1/220~240/50	1/220~240/50	
Mode*1)			HP / HR	HP / HR	HP / HR	
Performance	Capacity	Cooling*2)	kW	2.2	2.8	3.6
			Btu/h	7,500	9,500	12,200
	Heating*3)	kW	2.6	3.2	4.0	
		Btu/h	8,500	10,900	13,600	
Condensate (with High fan speed)		Liters/h	1.12	1.44	1.6	
Power	Input	W	50*5)	45*5)	50*5)	
	Running Current	A	0.20*5)	0.23*5)	0.25*5)	
Sound Level	Sound Pressure*4)		dB(A)	34	37	40
Fan	Type	-	Crossflow fan	Crossflow fan	Crossflow fan	
	Motor	Model	-	Y4S476B041L	Y4S476B041L	Y4S476B041L
		Type	-	Feedback SSR	Feedback SSR	Feedback SSR
		Output	W	-	-	-
Air Flow Rate		m ³ /min	6/5/4	7/6/5	8/7/6	
Refrigerant	Type	-	R410A	R410A	R410A	
	Control Method	-	EEV	EEV	EEV	
Temperature Control		-	Micom & Thermistors	Micom & Thermistors	Micom & Thermistors	
Safety Devices		-	Fuse	Fuse	Fuse	
Piping Connections	Liquid (Flare)	ø, mm	6.35	6.35	6.35	
	Gas (Flare)	ø, mm	12.7	12.7	12.7	
	Drain (Quick Lock)	ø, mm	VP20 (OD 25, ID 20)	VP20 (OD 25, ID 20)	VP20 (OD 25, ID 20)	
Weight	Net Weight	kg	10.5	10.5	10.5	
	Shipping Weight	kg	13.0	13.0	13.0	
Dimensions	Net Dimensions (W x H x D)	mm	970x135x410	970x135x410	970x135x410	
	Shipping Dimensions (W x H x D)	mm	1,164x212x478	1,164x212x478	1,164x212x478	
Panel Size	Model	-	PC1NUSMAN	PC1NUSMAN	PC1NUSMAN	
	Net Weight	kg	3.0	3.0	3.0	
	Shipping Weight	kg	5.0	5.0	5.0	
	Net Dimensions (W x H x D)	mm	1,180x25x460	1,180x25x460	1,180x25x460	
	Shipping Dimensions (W x H x D)	mm	1,259x144x539	1,259x144x539	1,259x144x539	
Functions	Auto Restart	-	O	O	O	
	Auto Swing	-	O	O	O	
	Group/Individual Control	-	O	O	O	
	External Contact Control	-	O	O	O	
	Trouble Shooting by LED	-	O	O	O	
Standard Accessories	Installation Manual	-	O	O	O	
	Operation Manual	-	X	X	X	
	Pattern Sheet for Installation	-	O	O	O	
	Flexible Drain Hose	-	O	O	O	
	Filter / Safety Grille	-	Filter (Washable)	Filter (Washable)	Filter (Washable)	
Drain Pump (Pumping speed, lift)	ℓ/h,mm	24, 750	24, 750	24, 750		
Optional Accessories	Wireless Remote Controller	-	MR-DH00	MR-DH00	MR-DH00	
	Wired Remote Controller	-	MWR-WE10N	MWR-WE10N	MWR-WE10N	
	External Contact Interface Module	-	MIM-B14	MIM-B14	MIM-B14	



*1) Mode

- HP : Heat Pump, HR : Heat Recovery

*2) Nominal cooling capacities are based on;

- Indoor temperature : 27°C DB, 19°C WB

- Outdoor temperature : 35°C DB, 24°C WB, Equivalent refrigerant piping : 7.5m, Level differences : 0m

*3) Nominal heating capacities are based on;

- Indoor temperature : 20°C DB, 15°C WB

- Outdoor temperature : 7°C DB, 6°C WB, Equivalent refrigerant piping : 7.5m, Level differences : 0m

*4) Sound pressure was acquired in a dead room. Thus actual noise level may be different depending on the installation conditions.

*5) Specifications may be subject to change without prior notice for product improvement.

Indoor Unit(cont.)

■ 2 way cassette type

Model			AM056JN1DEH/TK	AM071JN1DEH/TK	
Power Supply		ø/V/Hz	1/220~240/50	1/220~240/50	
Mode*1)			HP/HR	HP/HR	
Performance	Capacity	Cooling*2)	kW	5.6	7.1
			Btu/h	19,100	24,200
	Heating*3)	kW	6.3	8.0	
		Btu/h	21,500	27,300	
Condensate (with High fan speed)		Liters/h	-	-	
Power	Input	W	55.0	80.0	
	Running Current	A	0.28	0.40	
Sound Level	Sound Pressure *4)	dB(A)	36	39	
Fan	Type		-	Crossflow Fan	Crossflow Fan
	Motor	Model	-	SIC-55CVL-F158-3 FDA6531SSH	SIC-55CVL-F158-3 FDA6531SSH
		Type	-	BLDC	BLDC
		Output	W	54W	54W
Airflow Rate	Cooling (High)	m ³ /min	16.00/14.00/12.50	17.00/15.50/14.00	
	Heating (High)	m ³ /min	R410A	R410A	
Refrigerant	Type	-	EEV	EEV	
	Control Method	-	Micom & Thermistors	Micom & Thermistors	
Temperature Control		-	Fuse	Fuse	
Safety Devices		-	6.35	9.52	
Piping Connections	Liquid (Flare)	ø, mm	12.7	15.88	
	Gas (Flare)	ø, mm	VP20 (OD 26,ID 20)	VP20 (OD 26,ID 20)	
	Drain (Quick Lock)	ø, mm	14	14	
Weight	Net Weight	kg	18	18	
	Shipping Weight	kg	1200 x 138 x 450	1200 x 138 x 450	
Dimensions	Net Dimensions (W x H x D)	mm	1435 x 224 x 525	1435 x 224 x 525	
	Shipping Dimensions (W x H x D)	mm	PC1BWSMAN	PC1BWSMAN	
Panel Size	Model	-	6.3	6.3	
	Net Weight	kg	8.3	8.3	
	Shipping Weight	kg	1410 x 23 x 500	1410 x 23 x 500	
	Net Dimensions (W x H x D)	mm	1474 x 122 x 566	1474 x 122 x 566	
	Shipping Dimensions (W x H x D)	mm	1,103x151x727	1,103x151x727	
Functions	Auto Restart	-	O	O	
	Auto Swing	-	O	O	
	Group/Individual Control	-	O	O	
	External Contact Control	-	O	O	
	Trouble Shooting by LED	-	O	O	
Standard Accessories	Installation Manual	-	O	O	
	Operation Manual	-	X	X	
	Pattern Sheet for Installation	-	O	O	
	Flexible Drain Hose	-	O	O	
	Filter / Safety Grille	-	Filter (Washable)	Filter (Washable)	
	Drain Pump (Pumping speed, lift)	ℓ/h,mm	24, 750	24, 750	
Optional Accessories	Wireless Remote Controller	-	MR-DH00	MR-DH00	
	Wired Remote Controller	-	MWR-WE10N	MWR-WE10N	
	External Contact Interface Module	-	MIM-B14	MIM-B14	



*1) Mode

- HP : Heat Pump, HR : Heat Recovery

*2) Nominal cooling capacities are based on;

- Indoor temperature : 27°C DB, 19°C WB

- Outdoor temperature : 35°C DB, 24°C WB, Equivalent refrigerant piping : 7.5m, Level differences : 0m

*3) Nominal heating capacities are based on;

- Indoor temperature : 20°C DB, 15°C WB

- Outdoor temperature : 7°C DB, 6°C WB, Equivalent refrigerant piping : 7.5m, Level differences : 0m

*4) Sound pressure was acquired in a dead room. Thus actual noise level may be different depending on the installation conditions.

*5) Specifications may be subject to change without prior notice for product improvement.

Indoor Unit(cont.)

■ 2 way cassette type

Model			AM056FN2DEH/TK	AM071FN2DEH/TK	
Power Supply		ø/V/Hz	1/220~240/50	1/220~240/50	
Mode*1)			HP / HR	HP / HR	
Performance	Capacity	Cooling*2)	kW	5.6	7.1
			Btu/h	19,100	24,200
	Heating*3)	kW	6.3	8.0	
		Btu/h	21,400	27,200	
Condensate (with High fan speed)		Liters/h	2.87	3.19	
Power	Input	W	70	75	
	Running Current	A	0.38	0.40	
Sound Level	Sound Pressure *4)	dB(A)	45	46	
Fan	Type	-	Crossflow fan	Crossflow fan	
	Motor	Model	-	PFS027WTVB	PFS027WTVB
		Type	-	Feedback SSR	Feedback SSR
		Output	W	14.0 x 2	14.0 x 2
Airflow Rate	Cooling (High)	m ³ /min	14	14	
	Heating (High)	m ³ /min	16	16	
Refrigerant	Type	-	R410A	R410A	
	Control Method	-	EEV	EEV	
Temperature Control		-	Micom & Thermistors	Micom & Thermistors	
Safety Devices		-	Fuse	Fuse	
Piping Connections	Liquid (Flare)	ø, mm	6.35	9.52	
	Gas (Flare)	ø, mm	12.70	15.88	
	Drain (Quick Lock)	ø, mm	VP25 (OD 32, ID 25)	VP25 (OD 32, ID 25)	
Weight	Net Weight	kg	21.0	22.0	
	Shipping Weight	kg	25.0	26.0	
Dimensions	Net Dimensions (W x H x D)	mm	890x230x575	890x230x575	
	Shipping Dimensions (W x H x D)	mm	1,077x299x642	1,077x299x642	
Panel Size	Model	-	PC2NUSMEN	PC2NUSMEN	
	Net Weight	kg	4.0	4.0	
	Shipping Weight	kg	8.0	8.0	
	Net Dimensions (W x H x D)	mm	1,030x25x650	1,030x25x650	
	Shipping Dimensions (W x H x D)	mm	1,103x151x727	1,103x151x727	
Functions	Auto Restart	-	O	O	
	Auto Swing	-	O	O	
	Group/Individual Control	-	O	O	
	External Contact Control	-	O	O	
	Trouble Shooting by LED	-	O	O	
Standard Accessories	Installation Manual	-	O	O	
	Operation Manual	-	X	X	
	Pattern Sheet for Installation	-	O	O	
	Flexible Drain Hose	-	O	O	
	Filter / Safety Grille	-	Filter (Washable)	Filter (Washable)	
Drain Pump (Pumping speed, lift)	ℓ/h,mm	24, 750	24, 750		
Optional Accessories	Wireless Remote Controller	-	MR-DH00	MR-DH00	
	Wired Remote Controller	-	MWR-WE10N	MWR-WE10N	
		-	MWR-WS00	MWR-WS00	
	External Contact Interface Module	-	MIM-B14	MIM-B14	



*1) Mode

- HP : Heat Pump, HR : Heat Recovery

*2) Nominal cooling capacities are based on;

- Indoor temperature : 27°C DB, 19°C WB

- Outdoor temperature : 35°C DB, 24°C WB, Equivalent refrigerant piping : 7.5m, Level differences : 0m

*3) Nominal heating capacities are based on;

- Indoor temperature : 20°C DB, 15°C WB

- Outdoor temperature : 7°C DB, 6°C WB, Equivalent refrigerant piping : 7.5m, Level differences : 0m

*4) Sound pressure was acquired in a dead room. Thus actual noise level may be different depending on the installation conditions.

*5) Specifications may be subject to change without prior notice for product improvement.

Indoor Unit(cont.)

■ 4 way cassette

Model			AM045FN4DEH/TK	AM056FN4DEH/TK	AM071FN4DEH/TK	AM090FN4DEH/TK	
Power Supply		øV/Hz	1/220~240/50	1/220~240/50	1/220~240/50	1/220~240/50	
Mode*1)			HP / HR	HP / HR	HP / HR	HP / HR	
Performance	Capacity	Cooling*2)	kW	4.5	5.6	7.1	9.0
			Btu/h	15,300	19,100	24,200	30,700
		Heating*3)	kW	5.0	6.3	8.0	10.0
			Btu/h	17,000	21,400	27,200	34,100
	Condensate (with High fan speed)		Liters/h	2.23	2.71	3.51	4.46
Power	Input	W	32	32	45	62	
	Running Current	A	0.22	0.22	0.31	0.43	
Sound Level	Sound Pressure (Cooling/Heating)*4)		dB(A)	42 / 44	42 / 44	44 / 44	47 / 47
Fan	Type		-	Turbo Fan	Turbo Fan	Turbo Fan	Turbo Fan
	Motor	Model	-	FMC6531SSH	FMC6531SSH	FMC6531SSH	FMC6531SSH
		Type	-	BLDC	BLDC	BLDC	BLDC
		Output	W	*5)	*5)	*5)	*5)
Airflow Rate	Cooling (High)	m ³ /min	14.5	14.5	17	19.5	
	Heating (High)	m ³ /min	16.5	16.5	18.5	21.5	
Refrigerant	Type	-	R410A	R410A	R410A	R410A	
	Control Method	-	EEV	EEV	EEV	EEV	
Temperature Control		-	Micom & Thermistors	Micom & Thermistors	Micom & Thermistors	Micom & Thermistors	
Safety Devices		-	Fuse	Fuse	Fuse	Fuse	
Piping Connections	Liquid (Flare)	ø, mm	6.35	6.35	9.52	9.52	
	Gas (Flare)	ø, mm	12.7	12.7	15.88	15.88	
	Drain (Quick Lock)	ø, mm	VP25 (OD 32,ID 25)	VP25 (OD 32,ID 25)	VP25 (OD 32,ID 25)	VP25 (OD 32,ID 25)	
Weight	Net Weight	kg	25.0	25.0	25.0	25.0	
	Shipping Weight	kg	31.0	31.0	31.0	31.0	
Dimensions	Net Dimensions (W x H x D)	mm	840x204x840	840x204x840	840x204x840	840x204x840	
	Shipping Dimensions (W x H x D)	mm	898x275x898	898x275x898	898x275x898	898x275x898	
Panel Size	Model	-	PC4NUSKAN	PC4NUSKAN	PC4NUSKAN	PC4NUSKAN	
	Net Weight	kg	6.7	6.7	6.7	6.7	
	Shipping Weight	kg	8.9	8.9	8.9	8.9	
	Net Dimensions (W x H x D)	mm	950x30x950	950x30x950	950x30x950	950x30x950	
	Shipping Dimensions (W x H x D)	mm	1,042x93x1,042	1,042x93x1,042	1,042x93x1,042	1,042x93x1,042	
Functions	Auto Restart	-	O	O	O	O	
	Auto Swing	-	O	O	O	O	
	Group/Individual Control	-	O	O	O	O	
	External Contact Control	-	O	O	O	O	
	Trouble Shooting by LED	-	O	O	O	O	
Standard Accessories	Installation Manual	-	O	O	O	O	
	Operation Manual	-	X	X	X	X	
	Pattern Sheet for Installation	-	O	O	O	O	
	Flexible Drain Hose	-	O	O	O	O	
	Filter / Safety Grille	-	Filter / Safety Grille	Filter / Safety Grille	Filter / Safety Grille	Filter / Safety Grille	
	Drain Pump (Pumping speed, lift)	ℓ/h,mm	24, 750	24, 750	24, 750	24, 750	
Optional Accessories	Wireless Remote Controller	-	MR-DH00	MR-DH00	MR-DH00	MR-DH00	
	Wired Remote Controller	-	MWR-WE10N	MWR-WE10N	MWR-WE10N	MWR-WE10N	
	External Contact Interface Module	-	MIM-B14	MIM-B14	MIM-B14	MIM-B14	



*1) Mode

- HP : Heat Pump, HR : Heat Recovery

*2) Nominal cooling capacities are based on;

- Indoor temperature : 27°C DB, 19°C WB

- Outdoor temperature : 35°C DB, 24°C WB, Equivalent refrigerant piping : 7.5m, Level differences : 0m

*3) Nominal heating capacities are based on;

- Indoor temperature : 20°C DB, 15°C WB

- Outdoor temperature : 7°C DB, 6°C WB, Equivalent refrigerant piping : 7.5m, Level differences : 0m

*4) Sound pressure was acquired in a dead room. Thus actual noise level may be different depending on the installation conditions.

*5) Specifications may be subject to change without prior notice for product improvement.

Indoor Unit(cont.)

■ 4 way cassette(cont.)

Model			AM112FN4DEH/TK	AM128FN4DEH/TK	AM140FN4DEH/TK	
Power Supply		ø/V/Hz	1/220~240/50	1/220~240/50	1/220~240/50	
Mode*1)			HP / HR	HP / HR	HP / HR	
Performance	Capacity	Cooling*2)	kW	11.2	12.8	14.0
			Btu/h	38,200	43,600	47,700
	Heating*3)	kW	12.5	13.8	16.0	
		Btu/h	42,600	47,000	54,500	
Condensate (with High fan speed)		Liters/h	5.58	6.22	7.18	
Power	Input	W	78	73	89	
	Running Current	A	0.55	0.51	0.62	
Sound Level	Sound Pressure (Cooling / Heating)*4)	dB(A)	49 / 49	50 / 50	53 / 53	
Fan	Type		-	Turbo Fan	Turbo Fan	Turbo Fan
	Motor	Model	-	DAI33585ZLB	DAI33585ZLB	DAI33585ZLB
		Type	-	BLDC	BLDC	BLDC
		Output	W	*5)	*5)	*5)
Airflow Rate	Cooling (High)	m ³ /min	23.0	25.0	26.5	
	Heating (High)	m ³ /min	26.5	29.5	32.0	
Refrigerant	Type	-	R410A	R410A	R410A	
	Control Method	-	EEV	EEV	EEV	
Temperature Control		-	Micom & Thermistors	Micom & Thermistors	Micom & Thermistors	
Safety Devices		-	Fuse	Fuse	Fuse	
Piping Connections	Liquid (Flare)	ø, mm	9.52	9.52	9.52	
	Gas (Flare)	ø, mm	15.88	15.88	15.88	
	Drain (Quick Lock)	ø, mm	VP25 (OD 32,ID 25)	VP25 (OD 32,ID 25)	VP25 (OD 32,ID 25)	
Weight	Net Weight	kg	17.0	19.0	19.0	
	Shipping Weight	kg	20.0	22.5	22.5	
Dimensions	Net Dimensions (W x H x D)	mm	840x246x840	840x288x840	840x288x840	
	Shipping Dimensions (W x H x D)	mm	898x316x898	898x357x898	898x357x898	
Panel Size	Model	-	PC4NUSKAN	PC4NUSKAN	PC4NUSKAN	
	Net Weight	kg	6.7	6.7	6.7	
	Shipping Weight	kg	8.9	8.9	8.9	
	Net Dimensions (W x H x D)	mm	950x30x950	950x30x950	950x30x950	
	Shipping Dimensions (W x H x D)	mm	1,042x83x1,042	1,042x83x1,042	1,042x83x1,042	
Functions	Auto Restart	-	O	O	O	
	Auto Swing	-	O	O	O	
	Group/Individual Control	-	O	O	O	
	External Contact Control	-	O	O	O	
	Trouble Shooting by LED	-	O	O	O	
Standard Accessories	Installation Manual	-	O	O	O	
	Operation Manual	-	X	X	X	
	Pattern Sheet for Installation	-	O	O	O	
	Flexible Drain Hose	-	O	O	O	
	Filter / Safety Grille	-	Filter / Safety Grille	Filter / Safety Grille	Filter / Safety Grille	
Drain Pump (Pumping speed, lift)	ℓ/h,mm	24, 750	24, 750	24, 750		
Optional Accessories	Wireless Remote Controller	-	AR-DH00	AR-DH00	AR-DH00	
	Wired Remote Controller	-	MWR-WE10N	MWR-WE10N	MWR-WE10N	
		-	MWR-WS00	MWR-WS00	MWR-WS00	
External Contact Interface Module	-	MIM-B14	MIM-B14	MIM-B14		



*1) Mode

- HP : Heat Pump, HR : Heat Recovery

*2) Nominal cooling capacities are based on;

- Indoor temperature : 27°C DB, 19°C WB

- Outdoor temperature : 35°C DB, 24°C WB, Equivalent refrigerant piping : 7.5m, Level differences : 0m

*3) Nominal heating capacities are based on;

- Indoor temperature : 20°C DB, 15°C WB

- Outdoor temperature : 7°C DB, 6°C WB, Equivalent refrigerant piping : 7.5m, Level differences : 0m

*4) Sound pressure was acquired in a dead room. Thus actual noise level may be different depending on the installation conditions.

*5) Specifications may be subject to change without prior notice for product improvement.

Indoor Unit(cont.)

■ Mini 4 Way Cassette

Model				AM022FNNDH/TK	AM028FNNDH/TK	AM036FNNDH/TK
Power Supply		ø/V/Hz		1,2,220-240,50	1,2,220-240,50	1,2,220-240,50
Mode*1)				HP/HR	HP/HR	HP/HR
Performance	Capacity (Nominal)	Cooling*2)	kW	2.2	2.8	3.6
			Btu/h	7,500	9,600	12,300
		Heating*3)	kW	2.5	3.2	4
			Btu/h	8,500	10,900	13,600
Power	Power Input (Nominal)	Cooling*2)	W	18	18	20
		Heating*3)	W	18	18	20
	Current Input (Nominal)	Cooling*2)	A	0.17	0.17	0.19
		Heating*3)	A	0.17	0.17	0.19
Fan	Motor	Type	-	Turbo Fan	Turbo Fan	Turbo Fan
		Output	W	65 x 1	65 x 1	65 x 1
	Air Flow Rate	H/M/L (UL)	CMM	9.80/8.60/7.40	10.60/9.40/8.20	11.40/10.20/9.00
			CFM	350/300/260	370/330/290	400/360/320
	External Pressure	Min / Std / Max	mmAq	-	-	-
Pa			-	-	-	
Piping Connections	Liquid (Flare)	ø, mm	6.35	6.35	6.35	
		ø, inch	1/4"	1/4"	1/4"	
	Gas (Flare)	ø, mm	12.7	12.7	12.7	
		ø, inch	1/2"	1/2"	1/2"	
	Drain (Quick Lock)	ø, mm	VP25 (OD 32,ID 25)	VP25 (OD 32,ID 25)	VP25 (OD 32,ID 25)	
Field Wiring	Power Source Wire	Below 20m / over 20m	mm ²	1.5 ~ 2.5	1.5 ~ 2.5	1.5 ~ 2.5
	Transmission Cable		mm ²	0.75 ~ 1.50	0.75 ~ 1.50	0.75 ~ 1.50
Refrigerant	Type		-	R410A	R410A	R410A
	Control Method		-	EEV INCLUDED	EEV INCLUDED	EEV INCLUDED
Sound	Sound Pressure	COOLING / HEATING (HIGH)	dB(A)	38/40	40/40	42/40
Dimensions	Net Weight		kg	12.0	12.0	12.0
	Shipping Weight		kg	14.0	14.0	14.0
	Net Dimensions (W x H x D)		mm	575 x 250 x 575	75 x 250 x 575	575 x 250 x 575
	Shipping Dimensions (W x H x D)		mm	623 x 298 x 653	623 x 298 x 623	623 x 298 x 653
Panel Size	Panel model		-	PC4SUSMAN/PC4SUSMEN	PC4SUSMAN/PC4SUSMEN	PC4SUSMAN/PC4SUSMEN
	Panel Net Weight		-	2.7	2.7	2.7
	Shipping Weight		-	4.2	4.2	4.2
	Net Dimensions (WxHxD)		-	670 x 45 x 670	670 x 45 x 670	670 x 45 x 670
	Shipping Dimensions (WxHxD)		-	714 x 106 x 724	714 x 106 x 724	714 x 106 x 724
Additional Accessories	Drain pump	Drain pump	- / Model	Built-in	Built-in	Built-in
		Max. lifting Height / Displacement	mm/liter/h	750/24	750/24	750/24
	Air Filter		-	Long life filter	Long life filter	Long life filter



*1) Mode

- HP : Heat Pump, HR : Heat Recovery

*2) Nominal cooling capacities are based on;

- Indoor temperature : 27°C DB, 19°C WB

- Outdoor temperature : 35°C DB, 24°C WB, Equivalent refrigerant piping : 7.5m, Level differences : 0m

*3) Nominal heating capacities are based on;

- Indoor temperature : 20°C DB, 15°C WB

- Outdoor temperature : 7°C DB, 6°C WB, Equivalent refrigerant piping : 7.5m, Level differences : 0m

*4) Sound pressure was acquired in a dead room. Thus actual noise level may be different depending on the installation conditions.

*5) Specifications may be subject to change without prior notice for product improvement.

Indoor Unit(cont.)

■ Mini 4 Way Cassette (cont.)

Model			AM045FNNDH/TK	AM056FNNDH/TK	AM060FNNDH/TK	
Power Supply			ø/V/Hz	1,2,220-240,50	1,2,220-240,50	
Mode*1)			-	HP/HR	HP/HR	
Performance	Capacity (Nominal)	Cooling*2)	kW	4.50	5.60	6.00
			Btu/h	15,400	19,100	20,500
		Heating*3)	kW	5.00	6.30	6.80
			Btu/h	17,100	21,500	23,200
Power	Power Input (Nominal)	Cooling*2)	W	23.00	28.00	31.00
		Heating*3)	W	23.00	28.00	31.00
	Current Input (Nominal)	Cooling*2)	A	0.22	0.27	0.30
		Heating*3)	A	0.22	0.27	0.30
Fan	Motor	Type	-	Turbo Fan	Turbo Fan	
		Output	W	65 x 1	65 x 1	
	Air Flow Rate	H/M/L (UL)	CMM	12.20/11.00/9.80	13.40/11.80/10.20	14.20/12.60/11.00
			CFM	430/390/350	470/420/360	500/440/390
	External Pressure	Min / Std / Max	mmAq	-	-	-
Pa			-	-	-	
Piping Connections	Liquid (Flare)	ø, mm	6.35	6.35	6.35	
		ø, inch	1/4"	1/4"	1/4"	
	Gas (Flare)	ø, mm	12.7	12.7	12.7	
		ø, inch	1/2"	1/2"	1/2"	
	Drain (Quick Lock)	ø, mm	VP25 (OD 32,ID 25)	VP25 (OD 32,ID 25)	VP25 (OD 32,ID 25)	
Field Wiring	Power Source Wire	mm ²	1.5 ~ 2.5	1.5 ~ 2.5	1.5 ~ 2.5	
	Transmission Cable	mm ²	0.75 ~ 1.50	0.75 ~ 1.50	0.75 ~ 1.50	
Refrigerant	Type	-	R410A	R410A	R410A	
	Control Method	-	EEV INCLUDED	EEV INCLUDED	EEV INCLUDED	
Sound	Sound Pressure	COOLING / HEATING (HIGH)	dBA	43/43	46/47	47/47
Dimensions	Net Weight		kg	12	12	12
	Shipping Weight		kg	14	14	14
	Net Dimensions (W x H x D)		mm	575 x 250 x 575	575 x 250 x 575	575 x 250 x 575
	Shipping Dimensions (W x H x D)		mm	623 x 298 x 653	623 x 298 x 653	623 x 298 x 653
Panel Size	Panel model		-	PC4SUSMAN/PC4SUSMEN	PC4SUSMAN/PC4SUSMEN	PC4SUSMAN/PC4SUSMEN
	Panel Net Weight		kg	2.7	2.7	2.7
	Shipping Weight		kg	4.2	4.2	4.2
	Net Dimensions (WxHxD)		mm	670 x 45 x 670	670 x 45 x 670	670 x 45 x 670
	Shipping Dimensions (WxHxD)		mm	714 x 106 x 724	714 x 106 x 724	714 x 106 x 724
Additional Accessories	Drain pump	Drain pump	- / Model	Built-in	Built-in	Built-in
		Max. lifting Height / Displacement	mm/liter/h	750/24	750/24	750/24
	Air Filter		-	Long life filter	Long life filter	Long life filter



*1) Mode

- HP : Heat Pump, HR : Heat Recovery

*2) Nominal cooling capacities are based on;

- Indoor temperature : 27°C DB, 19°C WB

- Outdoor temperature : 35°C DB, 24°C WB, Equivalent refrigerant piping : 7.5m, Level differences : 0m

*3) Nominal heating capacities are based on;

- Indoor temperature : 20°C DB, 15°C WB

- Outdoor temperature : 7°C DB, 6°C WB, Equivalent refrigerant piping : 7.5m, Level differences : 0m

*4) Sound pressure was acquired in a dead room. Thus actual noise level may be different depending on the installation conditions.

*5) Specifications may be subject to change without prior notice for product improvement.

Indoor Unit(cont.)

■ **360 cassette**

Model			AM045KN4DEH*	AM056KN4DEH*	AM071KN4DEH*	AM090KN4DEH*	AM112KN4DEH*	AM128KN4DEH*	AM140KN4DEH*	
Power Supply		Φ, V, Hz	1,220-240,50	1,220-240,50	1,220-240,50	1,220-240,50	1,220-240,50	1,220-240,50	1,220-240,50	
Mode		-	HP/HR	HP/HR	HP/HR	HP/HR	HP/HR	HP/HR	HP/HR	
Performance	Capacity (Nominal)	Cooling ²⁾	kW	4.5	5.6	7.1	9.0	11.2	12.8	14.0
		Heating ²⁾	kW	5.0	6.3	8.0	10.0	12.5	13.8	16.0
Power	Power Input	Cooling ¹⁾	W	26	30	34	55	53	77	91
		Heating ²⁾	W	26	30	34	55	53	77	91
	Current Input	Cooling ¹⁾	A	0.18	0.21	0.25	0.42	0.41	0.62	0.75
		Heating ²⁾	A	0.18	0.21	0.25	0.42	0.41	0.62	0.75
Fan	Type	Type	-	Turbo Fan	Turbo Fan	Turbo Fan	Turbo Fan	Turbo Fan	Turbo Fan	
	Motor	Output x n	W	65	65	65	65	97	97	97
	Air Flow Rate	H/M/L (UL)	CMM	14.5/13.5/12.5	16.0/14.5/13.5	18.0/16.0/14.0	22.0/18.5/16.0	25.5/21.0/17.5	29.5/24.0/19.0	31.5/26.5/21.0
Piping Connections	Liquid Pipe		Φ,mm	6.35	6.35	9.52	9.52	9.52	9.52	9.52
			Φ, inch	1/4	1/4	3/8	3/8	3/8	3/8	3/8
	Gas Pipe		Φ,mm	12.7	12.7	15.88	15.88	15.88	15.88	15.88
			Φ, inch	1/2	1/2	5/8	5/8	5/8	5/8	5/8
Refrigerant	Drain Pipe		Φ,mm	VP25(OD32/ID25)	VP25(OD32/ID25)	VP25(OD32/ID25)	VP25(OD32/ID25)	VP25(OD32/ID25)	VP25(OD32/ID25)	VP25(OD32/ID25)
	Type	-	-	R410A	R410A	R410A	R410A	R410A	R410A	R410A
Control Method		-	-	EEV INCLUDED	EEV INCLUDED	EEV INCLUDED	EEV INCLUDED	EEV INCLUDED	EEV INCLUDED	EEV INCLUDED
External	Net Weight		kg	21	21	21	21	24	24	24
Dimension	Shipping Weight		kg	25	25	25	25	29	29	29
	Net Dimensions (WxHxD)		mm	947*281*947	947*281*947	947*281*947	947*281*947	947*365*947	947*365*947	947*365*947
	Shipping Dimensions (WxHxD)		mm	990*330*990	990*330*990	990*330*990	990*330*990	990*414*990	990*414*990	990*414*990
Panel Size (Ceiling Type)	Panel model		-	PC4NUDMAN	PC4NUDMAN	PC4NUDMAN	PC4NUDMAN	PC4NUDMAN	PC4NUDMAN	PC4NUDMAN
	Panel Net Weight		kg	3.6	3.6	3.6	3.6	3.6	3.6	3.6
	Shipping Weight		kg	6.0	6.0	6.0	6.0	6.0	6.0	6.0
	Net Dimensions (WxHxD)		mm	1000*66*1000	1000*66*1000	1000*66*1000	1000*66*1000	1000*66*1000	1000*66*1000	1000*66*1000
	Shipping Dimensions (WxHxD)		mm	1093*85*1083	1093*85*1083	1093*85*1083	1093*85*1083	1093*85*1083	1093*85*1083	1093*85*1083
Panel Size (Open Type)	Panel model		-	PC4NUNMAN	PC4NUNMAN	PC4NUNMAN	PC4NUNMAN	PC4NUNMAN	PC4NUNMAN	PC4NUNMAN
	Panel Net Weight		kg	2.7	2.7	2.7	2.7	2.7	2.7	2.7
	Shipping Weight		kg	5.1	5.1	5.1	5.1	5.1	5.1	5.1
	Net Dimensions (WxHxD)		mm	1050*94*1050	1050*94*1050	1050*94*1050	1050*94*1050	1050*94*1050	1050*94*1050	1050*94*1050
	Shipping Dimensions (WxHxD)		mm	1093*85*1083	1093*85*1083	1093*85*1083	1093*85*1083	1093*85*1083	1093*85*1083	1093*85*1083
Additional Accessories	Drain pump	Drain pump	- / Model name	Built In	Built In	Built In	Built In	Built In	Built In	Built In
		Max. lifting Height / Displacement	mm / liter/h	750/24	750/24	750/24	750/24	750/24	750/24	750/24
Functions	Auto Restart		-	0	0	0	0	0	0	0
	Auto Swing		-	0	0	0	0	0	0	0
	Group/Individual Control		-	0	0	0	0	0	0	0
	External Contact Control		-	0	0	0	0	0	0	0
	Trouble Shooting by LED		-	0	0	0	0	0	0	0
Standard Accessories	Install Manual		-	0	0	0	0	0	0	0
	User Manual		-	0	0	0	0	0	0	0
	Pattern Sheet for Installation		-	0	0	0	0	0	0	0
	Flexible Drain Hose		-	0	0	0	0	0	0	0
Optional Accessories	Wireless Remote Controller		-	MR-KH00	MR-KH00	MR-KH00	MR-KH00	MR-KH00	MR-KH00	MR-KH00
	Wired Remote Controller		-	MWR-WE10N	MWR-WE10N	MWR-WE10N	MWR-WE10N	MWR-WE10N	MWR-WE10N	MWR-WE10N
	External Contact Interface Module		-	MIM-B14	MIM-B14	MIM-B14	MIM-B14	MIM-B14	MIM-B14	MIM-B14

Indoor Unit(cont.)

■ Slim duct

Model			AM017FNLDEH/TK	AM022FNLDEH/TK	AM028FNLDEH/TK	AM036FNLDEH/TK	AM045FNLDEH/TK	AM056FNLDEH/TK	
Power Supply		ø/V/Hz	1/220~240/50	1/220~240/50	1/220~240/50	1/220~240/50	1/220~240/50	1/220~240/50	
Mode*1)			HP / HR	HP / HR	HP / HR	HP / HR	HP / HR	HP / HR	
Performance	Capacity	Cooling*2)	kW	1.7	2.2	2.8	3.6	4.5	5.6
			Btu/h	4,600	7,500	9,500	12,200	15,300	19,100
		Heating*3)	kW	1.9	2.5	3.2	4.0	5.0	6.3
			Btu/h	5,200	8,500	10,900	13,600	17,000	21,400
Condensate (with High fan speed)		Liters/h		0.80	1.12	1.28	2.07	2.39	
Power	Input	W	55	55	60	65	90	95	
	Running Current	A	0.3	0.3	0.32	0.33	0.52	0.53	
Sound Level	Sound Pressure *4)	dB(A)	37	37	37	37	40	43	
Fan	Type	-	Sirocco Fan	Sirocco Fan	Sirocco Fan	Sirocco Fan	Sirocco Fan	Sirocco Fan	
	Motor	Model	-	YSK95-28-4-B	YSK95-28-4-B	YSK95-28-4-B	YSK95-28-4-B	YSK110-50-4SM	YSK110-50-4SM
		Type	-	Non Feedback SSR	Non Feedback SSR	Non Feedback SSR	Non Feedback SSR	Non Feedback SSR	Non Feedback SSR
		Output	W	*5)	*5)	*5)	*5)	*5)	*5)
Airflow Rate	Cooling (High)	m ³ /min	5.0	4	7.5	7.5	11.0	12.0	
	Heating (High)	m ³ /min	5.5	8.2	9.0	9.0	14.0	15.0	
	External Static Pressure	Standard (Min~Max)	mmHzO	1(0~3)	1(0~3)	1(0~3)	1(0~3)	2(0~4)	2(0~4)
Refrigerant	Type	-	R410A	R410A	R410A	R410A	R410A	R410A	
	Control Method	-	EEV	EEV	EEV	EEV	EEV	EEV	
Temperature Control	-	Micom & Thermistors	Micom & Thermistors	Micom & Thermistors	Micom & Thermistors	Micom & Thermistors	Micom & Thermistors		
Safety Devices	-	Fuse	Fuse	Fuse	Fuse	Fuse	Fuse		
Piping Connections	Liquid (Flare)	ø, mm	6.35	6.35	6.35	6.35	6.35	6.35	
	Gas (Flare)	ø, mm	12.70	12.7	12.7	12.7	12.7	12.7	
	Drain	ø, mm	VP25 (OD 32,ID 25)	VP25 (OD 32,ID 25)	VP25 (OD 32,ID 25)	VP25 (OD 32,ID 25)	VP25 (OD 32,ID 25)	VP25 (OD 32,ID 25)	
Weight	Net Weight	kg	19.0	19.0	19.0	19.5	23.5	23.5	
	Shipping Weight	kg	23.0	23.0	23.0	23.5	28.0	28.0	
Dimensions	Net Dimensions (W x H x D)	mm	700x199x600	700x199x600	700x199x600	700x199x600	900x199x600	900x199x600	
	Shipping Dimensions (W x H x D)	mm	950x270x710	950x270x710	950x270x710	950x270x710	1150x280x710	1150x280x710	
Functions	Auto Restart	-	O	O	O	O	O	O	
	Auto Swing	-	X	X	X	X	X	X	
	Group/Individual Control	-	O	O	O	O	O	O	
	External Contact Control	-	O	O	O	O	O	O	
	Trouble Shooting by LED	-	X	X	X	X	X	X	
Standard Accessories	Installation Manual	-	O	O	O	O	O	O	
	Operation Manual	-	O	O	O	O	O	O	
	Pattern Sheet for Installation	-	X	X	X	X	X	X	
	Flexible Drain Hose	-	O	O	O	O	O	O	
	Filter / Safety Grille	-	Filter(Washable)	Filter (Washable)	Filter (Washable)	Filter (Washable)	Filter (Washable)	Filter (Washable)	
Drain Pump (Pumping speed, lift)	-	MR-BH01	MR-BH01	MR-BH01	MR-BH01	MR-BH01	MR-BH01		
Optional Accessories	Wireless Remote Controller	-	MR-DH00	MR-DH00	MR-DH00	MR-DH00	MR-DH00	MR-DH00	
	Duct Receiver Kits	Receiver	-	MRK-A10	MRK-A10	MRK-A10	MRK-A10	MRK-A10	
		Receiver Wire	-	MRW-10A	MRW-10A	MRW-10A	MRW-10A	MRW-10A	
	Wired Remote Controller	Simplified	-	MWR-WE10N	MWR-WE10N	MWR-WE10N	MWR-WE10N	MWR-WE10N	
	External Contact Interface Module		MIM-B14	MIM-B14	MIM-B14	MIM-B14	MIM-B14	MIM-B14	
Drain Pump		MDP-E075SEE3D	MDP-E075SEE3D	MDP-E075SEE3D	MDP-E075SEE3D	MDP-E075SEE3D	MDP-E075SEE3D		



*1) Mode

- HP : Heat Pump, HR : Heat Recovery

*2) Nominal cooling capacities are based on;

- Indoor temperature : 27°C DB, 19°C WB

- Outdoor temperature : 35°C DB, 24°C WB, Equivalent refrigerant piping : 7.5m, Level differences : 0m

*3) Nominal heating capacities are based on;

- Indoor temperature : 20°C DB, 15°C WB

- Outdoor temperature : 7°C DB, 6°C WB, Equivalent refrigerant piping : 7.5m, Level differences : 0m

*4) Sound pressure was acquired in a dead room. Thus actual noise level may be different depending on the installation conditions.

*5) Specifications may be subject to change without prior notice for product improvement.

Indoor Unit(cont.)

■ Slim duct(cont.)

Model			AM071FNLDEH/TK	AM090FNLDEH/TK	AM112FNLDEH/TK	AM128FNLDEH/TK	AM140FNLDEH/TK	
Power Supply		ø/V/Hz	1/220~240/50	1/220~240/50	1/220~240/50	1/220~240/50	1/220~240/50	
Mode*1)			HP / HR	HP / HR	HP / HR	HP / HR	HP / HR	
Performance	Capacity	Cooling*2)	kW	7.1	9.0	11.2	12.8	14.0
			Btu/h	24,200	30,700	38,200	43,600	47,700
		Heating*3)	kW	8.0	10.0	12.5	13.8	16.0
			Btu/h	27,200	34,100	42,600	47,000	54,500
Condensate (with High fan speed)		Liters/h	2.87	3.83	4.63	4.95	5.26	
Power	Input	W	120	170	170	200	220	
	Running Current	A	0.6	0.96	0.96	1.28	1.43	
Sound Level	Sound Pressure (High/Low)*4)	dB(A)	47 / 47	43 / 44	43 / 44	45 / 46	45 / 46	
Fan	Type		-	Sirocco Fan	Sirocco Fan	Sirocco Fan	Sirocco Fan	
	Motor	Model	-	YSK140-60-4B	DL-12840SSBC	DL-12840SSBC	DL-12840SSBC	
		Type	-	Non Feedback SSR	BLDC	BLDC	BLDC	
		Output	W	*5)	*5)	*5)	*5)	
Airflow Rate	Cooling (High)		m ³ /min	16.5	29.0	31.2	34.0	
	Heating (High)		m ³ /min	20.0	34.0	34.0	36.0	
	External Static Pressure	Standard(Min.~Max)	mmHzO	2 (0~4)	3 (0~6)	3 (0~6)	3 (0~6)	
Refrigerant	Type		-	R410A	R410A	R410A	R410A	
	Control Method		-	EEV	EEV	EEV	EEV	
Temperature Control		-	Micom&Thermistors	Micom&Thermistors	Micom&Thermistors	Micom&Thermistors	Micom&Thermistors	
Safety Devices		-	Fuse	Fuse	Fuse	Fuse	Fuse	
Piping Connections	Liquid (Flare)		ø, mm	9.52	9.52	9.52	9.52	
	Gas (Flare)		ø, mm	15.88	15.88	15.88	15.88	
	Drain		ø, mm	VP25 (OD 32,ID 25)	VP25 (OD 32,ID 25)	VP25 (OD 32,ID 25)	VP25 (OD 32,ID 25)	
Weight	Net Weight		kg	30.0	44.0	44.0	46.0	
	Shipping Weight		kg	35.0	52.0	52.0	54.0	
Dimensions	Net Dimensions (W x H x D)		mm	1,100x199x600	1,300x295x690	1,300x295x690	1,300x295x690	
	Shipping Dimensions (W x H x D)		mm	1350x280x710	1575x370x835	1575x370x835	1575x370x835	
Functions	Auto Restart		-	O	O	O	O	
	Auto Swing		-	X	X	X	X	
	Group/Individual Control		-	O	O	O	O	
	External Contact Control		-	O	O	O	O	
	Trouble Shooting by LED		-	X	X	X	X	
Standard Accessories	Installation Manual		-	O	O	O	O	
	Operation Manual		-	O	O	O	O	
	Pattern Sheet for Installation		-	X	X	X	X	
	Flexible Drain Hose		-	O	O	O	O	
	Filter / Safety Grille		-	Filter (Washable)	Filter (Washable)	Filter (Washable)	Filter (Washable)	
Drain Pump (Pumping speed, lift)		-	MR-BH01	MR-BH01	MR-BH01	MR-BH01		
Optional Accessories	Wireless Remote Controller		-	MR-DH00	MR-DH00	MR-DH00	MR-DH00	
	Duct Receiver Kits	Receiver	-	MRK-A10	MRK-A10	MRK-A10	MRK-A10	
		Receiver Wire	-	MRW-10A	MRW-10A	MRW-10A	MRW-10A	
	Wired Remote Controller	Simplified	-	MWR-WE10N	MWR-WE10N	MWR-WE10N	MWR-WE10N	
	External Contact Interface Module		-	MIM-B14	MIM-B14	MIM-B14	MIM-B14	
	Drain Pump		-	MDP-E075SEE3D	MDP-E075SEE3D	MDP-E075SEE3D	MDP-E075SEE3D	



*1) Mode

- HP : Heat Pump, HR : Heat Recovery

*2) Nominal cooling capacities are based on;

- Indoor temperature : 27°C DB, 19°C WB

- Outdoor temperature : 35°C DB, 24°C WB, Equivalent refrigerant piping : 7.5m, Level differences : 0m

*3) Nominal heating capacities are based on;

- Indoor temperature : 20°C DB, 15°C WB

- Outdoor temperature : 7°C DB, 6°C WB, Equivalent refrigerant piping : 7.5m, Level differences : 0m

*4) Sound pressure was acquired in a dead room. Thus actual noise level may be different depending on the installation conditions.

*5) Specifications may be subject to change without prior notice for product improvement.

Indoor Unit(cont.)

■ Duct Type (Uplevel Static Pressure)

Model			AM022FNMDEH/TK	AM028FNMDEH/TK	AM036FNMDEH/TK	AM045FNMDEH/TK		
Power Supply		ø/V/Hz	1/220~240/50	1/220~240/50	1/220~240/50	1/220~240/50		
Mode*1)			HP / HR	HP / HR	HP / HR	HP / HR		
Performance	Capacity	Cooling*2)	kW	2.2	2.8	3.6	4.5	
			Btu/h	7,500	9,500	12,200	15,300	
		Heating*3)	kW	2.5	3.2	4.0	5.0	
			Btu/h	8,500	10,900	13,600	17,000	
Power	Input	W	80	80	85	125		
	Running Current	A	0.4	0.4	0.55	1.15		
Sound Level	Sound Pressure (Cooling/Heating) *4)		dB(A)	37 / 38	38/39	39/40	44 / 46	
Fan	Type		-	Sirocco Fan	Sirocco Fan	Sirocco Fan	Sirocco Fan	
	Motor	Model	-	YSK110-25-4SM	YSK110-25-4SM	YSK110-50-4SM	YSK140-200-4E1	
		Type	-	Non Feedback SSR	Non Feedback SSR	Non Feedback SSR	Non Feedback SSR	
		Output	W	*5)	*5)	*5)	*5)	
Airflow Rate	Cooling (High)		m ³ /min	7.7	8.8	11.0	13.0	
	Heating (High)		m ³ /min	8.9	10.3	12.7	14.5	
	External Static Pressure	Standard(Min.-Max)	mmHzO	2 (0~4)	2 (0~4)	2 (0~4)	4 (0~8)	
Refrigerant	Type		-	R410A	R410A	R410A	R410A	
	Control Method		-	EEV	EEV	EEV	EEV	
Temperature Control			-	Micom&Thermistors	Micom&Thermistors	Micom&Thermistors	Micom&Thermistors	
Safety Devices			-	Fuse	Fuse	Fuse	Fuse	
Piping Connections	Liquid (Flare)	ø, mm	6.35	6.35	6.35	6.35		
	Gas (Flare)	ø, mm	12.7	12.7	12.7	12.7		
	Drain	ø, mm	VP25 (OD 32,ID 25)	VP25 (OD 32,ID 25)	VP25 (OD 32,ID 25)	VP25 (OD 32,ID 25)		
Weight	Net Weight	kg	23.5	23.5	23.5	29.0		
	Shipping Weight	kg	28.0	28.0	28.0	33.0		
Dimensions	Net Dimensions (W x H x D)		mm	900×199×600	900×199×600	900×199×600	900×260×480	
	Shipping Dimensions (W x H x D)		mm	1150×280×710	1150×280×710	1150×280×710	1170×595×340	
Functions	Auto Restart		-	O	O	O	O	
	Auto Swing		-	X	X	X	X	
	Group/Individual Control		-	O	O	O	O	
	External Contact Control		-	O	O	O	O	
	Trouble Shooting by LED		-	X	X	X	X	
Standard Accessories	Installation Manual			-	O	O	O	
	Operation Manual			-	O	O	O	
	Pattern Sheet for Installation			-	X	X	X	
	Flexible Drain Hose			-	O	O	O	
	Filter / Safety Grille			-	Filter (Washable)	Filter (Washable)	Filter (Washable)	Filter (Washable)
	Drain Pump (Pumping speed, lift)			-	MR-BH01	MR-BH01	MR-BH01	MR-BH01
Optional Accessories	Wireless Remote Controller			-	MR-DH00	MR-DH00	MR-DH00	
	Duct Receiver Kits	Receiver		-	MRK-A10	MRK-A10	MRK-A10	
		Receiver Wire		-	MRW-10A	MRW-10A	MRW-10A	
	Wired Remote Controller	Simplified		-	MWR-WE10N	MWR-WE10N	MWR-WE10N	
	External Contact Interface Module			-	MIM-B14	MIM-B14	MIM-B14	
Drain Pump			-	MDP-E075SEE3D	MDP-E075SEE3D	MDP-E075SEE3D		



*1) Mode

- HP : Heat Pump, HR : Heat Recovery

*2) Nominal cooling capacities are based on;

- Indoor temperature : 27°C DB, 19°C WB

- Outdoor temperature : 35°C DB, 24°C WB, Equivalent refrigerant piping : 7.5m, Level differences : 0m

*3) Nominal heating capacities are based on;

- Indoor temperature : 20°C DB, 15°C WB

- Outdoor temperature : 7°C DB, 6°C WB, Equivalent refrigerant piping : 7.5m, Level differences : 0m

*4) Sound pressure was acquired in a dead room. Thus actual noise level may be different depending on the installation conditions.

*5) Specifications may be subject to change without prior notice for product improvement.

Indoor Unit(cont.)

■ **MSP duct**

Model			AM056FNMDEH/TK	AM071FNMDEH/TK	AM090FNMDEH/TK	AM112FNMDEH/TK	AM128FNMDEH/TK	AM140FNMDEH/TK	AM160KNMDEH/TK	
Power Supply Mode*1)		øV/Hz	1/220~240/50	1/220~240/50	1/220~240/50	1/220~240/50	1/220~240/50	1/220~240/50	1/220~240/50	
Performance	Capacity	Cooling*2)	kW	5.6	7.1	9.0	11.2	12.8	14.0	16.0
			Btu/h	19,100	24,200	30,700	38,200	43,600	47,700	54,000
		Heating*3)	kW	6.3	8.0	10.0	12.5	13.8	16.0	18.0
			Btu/h	21,400	27,200	34,100	42,600	47,000	54,500	60,000
	Condensate (with High fan speed)		Liters/h			4.63	4.95	5.1	-	
Power	Input	W	130 ⁵⁾	190 ⁵⁾	240 ⁵⁾	260	370	410	485	
	Running Current	A	1.10 ⁵⁾	1.25 ⁵⁾	1.30 ⁵⁾	1.17	1.67	1.86	2.24	
Sound Level	Sound Pressure *4)	dB(A)	47	47	50	48	50	50	53	
Fan	Type		Sirocco Fan	Sirocco Fan	Sirocco Fan	Sirocco Fan	Sirocco Fan	Sirocco Fan	Sirocco Fan	
	Motor	Model	YSK140-200-4E1	YSK140-200-4E1	YSK140-200-4	YSK140-200-4	Y7S423C015	Y7S423C015	Y7S423C015	
		Type	Non Feedback SSR	Non Feedback SSR	Non Feedback SSR	Non Feedback SSR	Non Feedback SSR	Non Feedback SSR	Non Feedback SSR	
		Output	W	-	-	-	-	-	-	
Airflow Rate	Cooling (High)	m ³ /min	14.5	18.5	19.5	27.0	32.0	37.0	39.5	
	Heating (High)	m ³ /min	15.5	20.0	21.5	27.0	31.0	36.0	42.0	
	External Static Pressure	Standard(Min.-Max)	mmH ₂ O	4(0~8)	4(0~8)	6(4~8)	8(4~12)	8(4~12)	8(4~12)	8(4~14)
Refrigerant	Type		R410A	R410A	R410A	R410A	R410A	R410A	R410A	
	Control Method		EEV	EEV	EEV	EEV	EEV	EEV	EEV	
Temperature Control			Micom&Thermistors	Micom&Thermistors	Micom&Thermistors	Micom&Thermistors	Micom&Thermistors	Micom&Thermistors	Micom&Thermistors	
Safety Devices			Fuse	Fuse	Fuse	Fuse	Fuse	Fuse	Fuse	
Piping Connections	Liquid (Flare)	ø, mm	6.35	9.52	9.52	9.52	9.52	9.52	9.52	
	Gas (Flare)	ø, mm	12.7	15.88	15.88	15.88	15.88	15.88	15.88	
	Drain	ø, mm	VP25 (OD 32,ID 25)	VP25 (OD 32,ID 25)	VP25 (OD 32,ID 25)	VP25 (OD 32,ID 25)	VP25 (OD 32,ID 25)	VP25 (OD 32,ID 25)	VP20 (OD 25, ID 20)	
Weight	Net Weight	kg	29.0	34.0	34.0	36.0	52.0	52.0	50.0	
	Shipping Weight	kg	33.0	33.0	39.0	42.0	59.0	59.0	57.0	
Dimensions	Net Dimensions (W x H x D)	mm	900x260x480	900x260x480	1,150x260x480	1,150x320x480	1,200x360x650	1,200x360x650	1,200x360x650	
	Shipping Dimensions (W x H x D)	mm	1,170x595x340	1,170x595x340	1,420x595x340	1,150x320x480	1,480x790x420	1,480x790x420	1,480x790x420	
Functions	Auto Restart		O	O	O	O	O	O	O	
	Auto Swing		X	X	X	X	X	X	X	
	Group/Individual Control		O	O	O	O	O	O	O	
	External Contact Control		O	O	O	O	O	O	O	
	Trouble Shooting by LED		X	X	X	X	X	X	X	
Standard Accessories	Installation Manual		O	O	O	O	O	O	O	
	Operation Manual		O	O	O	O	O	O	O	
	Pattern Sheet for Installation		X	X	X	X	X	X	X	
	Flexible Drain Hose		O	O	O	O	O	O	O	
	Filter / Safety Grille		Filter (Washable)	Filter (Washable)	Filter (Washable)	Filter (Washable)	Filter (Washable)	Filter (Washable)	Filter (Washable)	
Optional Accessories	Wireless Remote Controller		MR-DH00	MR-DH00	MR-DH00	MR-DH00	MR-DH00	MR-DH00	MR-DH00	
	Duct Receiver Kits	Receiver	MRK-A10	MRK-A10	MRK-A10	MRK-A10	MRK-A10	MRK-A10	MRK-A10	
		Receiver Wire	MRW-10A	MRW-10A	MRW-10A	MRW-10A	MRW-10A	MRW-10A	MRW-10A	
	Wired Remote Controller	Simplified	MWR-WE10N	MWR-WE10N	MWR-WE10N	MWR-WE10N	MWR-WE10N	MWR-WE10N	MWR-WE10N	
	External Contact Interface Module		MIM-B14	MIM-B14	MIM-B14	MIM-B14	MIM-B14	MIM-B14	MIM-B14	
	Drain Pump		MDP-M075SGU3D	MDP-M075SGU1D	MDP-M075SGU1D	MDP-M075SGU1D	MDP-M075SGU2D	MDP-M075SGU2D	MDP-M075SGU2D	

Indoor Unit(cont.)

■ Big Duct

Model			AM220FNHDEH/TK	AM280FNHDEH/TK	
Power Supply		ø/V/Hz	1/220-240/50	1/220-240/50	
Mode*1)			HP / HR	HP / HR	
Performance	Capacity	Cooling*2)	kW	22.4	28.0
			Btu/h	76,400	95,500
	Heating*3)	kW	25.0	31.5	
		Btu/h	85,300	107,500	
Condensate (with High fan speed)		Liters/h			
Power	Input		W	530	790
	Running Current		A	3.8	5.9
Sound Level	Sound Pressure (High/Low)*4)		dB(A)	47 / 44	48 / 45
Fan	Type		-	Sirocco Fan	Sirocco Fan
	Motor	Model	-	DL-13875SSOB	DL-13875SSOB
		Type	-	BLDC	BLDC
		Output	W		
Airflow Rate	Cooling (High)		m ³ /min	58	72
	Heating (High)		m ³ /min	58	72
	External Static Pressure	Standard(Min.-Max)	mmH ₂ O	15(5-25)	15(5-28)
Refrigerant	Type		-	R410A	R410A
	Control Method		-	EEV	EEV
Temperature Control		-	Micom&Thermistors	Micom&Thermistors	
Safety Devices		-	Fuse	Fuse	
Piping Connections	Liquid (Flare)		ø, mm	9.52	9.52
	Gas (Flare)		ø, mm	19.05	22.2
	Drain		ø, mm	VP25(OD32, ID25)	VP25(OD32, ID25)
Weight	Net Weight		kg	89	89
	Shipping Weight		kg	99	99
Dimensions	Net Dimensions (W x H x D)		mm	1,240x470x1,040	1,240x470x1,040
	Shipping Dimensions (W x H x D)		mm	1,507x558x1,155	1,507x558x1,155
Functions	Auto Restart		-	O	O
	Auto Swing		-	X	X
	Group/Individual Control		-	O	O
	External Contact Control		-	O	O
	Trouble Shooting by LED		-	X	X
Standard Accessories	Installation Manual		-	O	O
	Operation Manual		-	O	O
	Pattern Sheet for Installation		-	O	O
	Flexible Drain Hose		-	O	O
	Filter / Safety Grille		-	X	X
Optional Accessories	Wireless Remote Controller		-	MR-DH00	MR-DH00
	Duct Receiver Kits	Receiver	-	MRK-A10	MRK-A10
		Receiver Wire	-	MRW-10A	MRW-10A
	Wired Remote Controller	Simplified	-	MWR-WE10N	MWR-WE10N
	External Contact Interface Module		-	MIM-B14	MIM-B14
	Drain Pump		-	MDP-N047SNC1D	MDP-N047SNC1D



*1) Mode

- HP : Heat Pump, HR : Heat Recovery

*2) Nominal cooling capacities are based on;

- Indoor temperature : 27°C DB, 19°C WB

- Outdoor temperature : 35°C DB, 24°C WB, Equivalent refrigerant piping : 7.5m, Level differences : 0m

*3) Nominal heating capacities are based on;

- Indoor temperature : 20°C DB, 15°C WB

- Outdoor temperature : 7°C DB, 6°C WB, Equivalent refrigerant piping : 7.5m, Level differences : 0m

*4) Sound pressure was acquired in a dead room. Thus actual noise level may be different depending on the installation conditions.

*5) Specifications may be subject to change without prior notice for product improvement.

Indoor Unit(cont.)

■ HSP Duct

Model			AM112FNHDEH/TK	AM128FNHDEH/TK	AM140FNHDEH/TK	
Power Supply			ø/V/Hz	1/220~240/50	1/220~240/50	
Mode*1)				HP / HR	HP / HR	
Performance	Capacity	Cooling*2)	kW	11.2	12.8	
			Btu/h	38,200	43,600	
	Heating*3)	kW	12.5	13.8	16.0	
		Btu/h	42,600	47,000	54,500	
Condensate (with High fan speed)		Liters/h				
Power	Input	W	305	333	385	
	Running Current	A	2.35	2.58	3.0	
Sound Level	Sound Pressure (High/Low)*4)		dB(A)	43/40	45/40	
Fan	Type		-	Sirocco Fan AL, Ø226,L200, 2EA, KJBLWR	Sirocco Fan AL, Ø226,L200, 2EA, KJBLWR	
	Motor	Model	-	BLDC Motor (DL-12840SSB, 8Pole, Ø124)X2	BLDC Motor (DL-12840SSB, 8Pole, Ø124)X2	
		Type		-	BLDC	BLDC
		Output	W			
Airflow Rate	Cooling (High)		m ³ /min	33	35	
	Heating (High)		m ³ /min	35	37	
	External Static Pressure	Standard(Min.-Max)	mmH ₂ O	10 (5~20)	10 (5~20)	
Refrigerant	Type		-	R410A	R410A	
	Control Method		-	EEV	EEV	
Temperature Control			-	Micom&Thermistors	Micom&Thermistors	
Safety Devices			-	Fuse	Fuse	
Piping Connections	Liquid (Flare)	ø, mm		9.52	9.52	
	Gas (Flare)	ø, mm		15.88	15.88	
	Drain	ø, mm		VP25 (OD 32,ID 25)	VP25 (OD 32,ID 25)	
Weight	Net Weight	kg		62.0	62.0	
	Shipping Weight	kg		70.0	70.0	
Dimensions	Net Dimensions (W x H x D)		mm	1200x360x650	1200x360x650	
	Shipping Dimensions (W x H x D)		mm	1447x425x769	1447x425x769	
Functions	Auto Restart		-	O	O	
	Auto Swing		-	X	X	
	Group/Individual Control		-	O	O	
	External Contact Control		-	O	O	
	Trouble Shooting by LED		-	X	X	
Standard Accessories	Installation Manual		-	O	O	
	Operation Manual		-	O	O	
	Pattern Sheet for Installation		-	O	O	
	Flexible Drain Hose		-	O	O	
	Filter / Safety Grille		-	X	X	
Optional Accessories	Wireless Remote Controller		-	MR-DH00	MR-DH00	
	Duct Receiver Kits	Receiver	-	MRK-A10	MRK-A10	
		Receiver Wire	-	MRW-10A	MRW-10A	
	Wired Remote Controller	Simplified	-	MWR-WE10N	MWR-WE10N	
	External Contact Interface Module		-	MIM-B14	MIM-B14	
	Drain Pump			MDP-M075SGU2D	MDP-M075SGU2D	



*1) Mode

- HP : Heat Pump, HR : Heat Recovery

*2) Norminal cooling capacities are based on;

- Indoor temperature : 27°C DB, 19°C WB - Outdoor temperature : 35°C DB, 24°C WB

*3) Norminal heating capacities are based on;

- Indoor temperature : 20°C DB, 15°C WB - Outdoor temperature : 7°C DB, 6°C WB

*4) Sound pressure was acquired in a dead room. Thus actual noise level may be different depending on the installation conditions.

*5) Specifications may be subject to change without prior notice for product improvement.

Indoor Unit(cont.)

■ Ceiling type

Model			AM056FNCDEH/TK	AM071FNCDEH/TK	
Power Supply		ø/V/Hz	1/220~240/50	1/220~240/50	
Mode*1)			HP / HR	HP / HR	
Performance	Capacity	Cooling*2)	kW	5.6	7.1
			Btu/h	19,100	24,200
	Heating*3)	kW	6.3	8.0	
		Btu/h	21,400	27,200	
Condensate (with High fan speed)		Liters/h	2.87	2.87	
Power	Input		W	72/72	80/77
	Running Current		A	0.33/0.28	0.35/0.29
Sound Level	Sound Pressure (Cooling / Heating)*4)		dB(A)	45/45	47/47
Fan	Type		-	Sirocco Fan	Sirocco Fan
	Motor	Model	-	Y5S413B214	Y5S413B214
		Type	-	Non Feedback SSR	Non Feedback SSR
		Output	W	*5)	*5)
Airflow Rate	Cooling (High)		m ³ /min	16.5	16.5
	Heating (High)		m ³ /min	20.0	20.0
Refrigerant	Type		-	R410A	R410A
	Control Method		-	EEV	EEV
Temperature Control		-	Micom&Thermistors	Micom&Thermistors	
Safety Devices		-	Fuse	Fuse	
Piping Connections	Liquid (Flare)		ø, mm	6.35	9.52
	Gas (Flare)		ø, mm	12.7	15.88
	Drain		ø, mm	VP25 (OD 32,ID 25)	VP25 (OD 32,ID 25)
Weight	Net Weight		kg	21.0	21.0
	Shipping Weight		kg	25.5	25.5
Dimensions	Net Dimensions (W x H x D)		mm	1000x650x200	1000x650x200
	Shipping Dimensions (W x H x D)		mm	1080x730x300	1080x730x300
Functions	Auto Restart		-	O	O
	Auto Swing		-	X	X
	Group/Individual Control		-	O	O
	External Contact Control		-	O	O
	Trouble Shooting by LED		-	X	X
Standard Accessories	Installation Manual		-	O	O
	Operation Manual		-	O	O
	Pattern Sheet for Installation		-	X	X
	Flexible Drain Hose		-	O	O
	Filter / Safety Grille		-	Filter (Washable)	Filter (Washable)
Optional Accessories	Wireless Remote Controller		-	AR-DH00	AR-DH00
	Wired Remote Controller	Simplified	-	MWR-WE10N	MWR-WE10N
		External Contact Interface Module		-	MIM-B14



*1) Mode

- HP : Heat Pump, HR : Heat Recovery

*2) Norminal cooling capacities are based on;

- Indoor temperature : 27°C DB, 19°C WB

- Outdoor temperature : 35°C DB, 24°C WB , Equivalent refrigerant piping : 7.5m , Level differences : 0m

*3) Norminal heating capacities are based on;

- Indoor temperature : 20°C DB, 15°C WB

- Outdoor temperature : 7°C DB, 6°C WB , Equivalent refrigerant piping : 7.5m , Level differences : 0m

*4) Sound pressure was acquired in a dead room. Thus actual noise level may be different depending on the installation conditions.

*5) Specifications may be subject to change without prior notice for product improvement.

Indoor Unit(cont.)

■ Console type

Model			AM022KNJDEH/TK	AM028FNJDEH/TK	AM036FNJDEH/TK	AM045KNJDEH/TK	AM056FNJDEH/TK	
Power Supply		ø/V/Hz	1/220~240/50	1/220~240/50	1/220~240/50	1/220~240/50	1/220~240/50	
Mode*1)			HP / HR	HP / HR	HP / HR	HP / HR	HP / HR	
Performance	Capacity	Cooling*2)	kW	2.2	2.8	3.6	4.5	5.6
			Btu/h	7,500	9,600	12,300	15,400	19,100
		Heating*3)	kW	2.5	3.2	4.0	5.0	6.3
			Btu/h	8,500	11,000	13,600	17,100	21,400
Condensate (with High fan speed)		Liters/h		0.96	1.75		-	
Power	Input	W	16.0	30*5)	35*5)	36.0	62*5)	
	Running Current	A	0.13	0.25*5)	0.29*5)	0.30	0.49*5)	
Sound Level	Sound Pressure (Cooling / Heating)*4)		dB(A)	38/39	41/43	42/44	48/49	49/51
Fan	Type		-	Turbo Fan	Turbo Fan	Turbo Fan	Turbo Fan	Turbo Fan
	Motor	Model	-	SIC-55CV-F137-2	SIC-55CV-F137-2	SIC-55CV-F137-2	SIC-55CV-F137-2	SIC-55CV-F137-2
		Type	-	BLDC	BLDC	BLDC	BLDC	BLDC
		Output	W	37	37.0	37.0	37	37.0
Airflow Rate	Cooling (High)	m ³ /min	5.8*5)	7.76*5)	8.67*5)	11.0*5)	13.0*5)	
	Heating (High)	m ³ /min	6.3*5)	7.22*5)	8.89*5)	11.3*5)	13.5*5)	
Refrigerant	Type	-	R410A	R410A	R410A	R410A	R410A	
	Control Method	-	EEV	EEV	EEV	EEV	EEV	
Temperature Control		-	Micom&Thermistors	Micom&Thermistors	Micom&Thermistors	Micom&Thermistors	Micom&Thermistors	
Safety Devices		-	Fuse	Fuse	Fuse	Fuse	Fuse	
Piping Connections	Liquid (Flare)	ø, mm	6.35	6.35	6.35	6.35	6.35	
	Gas (Flare)	ø, mm	12.7	12.7	12.7	12.7	12.7	
	Drain	ø, mm	ID 18 hose	ID 18 hose	ID 18 hose	ID 18 hose	ID 18 hose	
Weight	Net Weight	kg	16.0	16.0	16.0	16.0	16.0	
	Shipping Weight	kg	21.0	21.0	21.0	21.0	21.0	
Dimensions	Net Dimensions (W x H x D)	mm	720x620x199	720x620x199	720x620x199	720x620x199	720x620x199	
	Shipping Dimensions (W x H x D)	mm	810x710x295	810x710x295	810x710x295	810x710x295	810x710x295	
Functions	Auto Restart	-	O	O	O	O	O	
	Auto Swing	-	O	O	O	O	O	
	Group/Individual Control	-	O	O	O	O	O	
	External Contact Control	-	O	O	O	O	O	
	Trouble Shooting by LED	-	O	O	O	O	O	
Standard Accessories	Installation Manual	-	O	O	O	O	O	
	Operation Manual	-	O	O	O	O	O	
	Pattern Sheet for Installation	-	X	X	X	X	X	
	Flexible Drain Hose	-	O	O	O	O	O	
	Filter / Safety Grille	-	Filter (Washable)	Filter (Washable)	Filter (Washable)	Filter (Washable)	Filter (Washable)	
	Wireless Remote Controller	-	ARH-1378(DB93-07547B)	ARH-1378(DB93-07547B)	ARH-1378(DB93-07547B)	ARH-1378(DB93-07547B)	ARH-1378(DB93-07547B)	
Optional Accessories	Wireless Remote Controller	-	MR-DH00	MR-DH00	MR-DH00	MR-DH00	MR-DH00	
	Wired Remote Controller	Simplified	-	MWR-WE10N	MWR-WE10N	MWR-WE10N	MWR-WE10N	
	External Contact Interface Module		-	MIM-B14	MIM-B14	MIM-B14	MIM-B14	



*1) Mode

- HP : Heat Pump, HR : Heat Recovery

*2) Nominal cooling capacities are based on;

- Indoor temperature : 27°C DB, 19°C WB

- Outdoor temperature : 35°C DB, 24°C WB, Equivalent refrigerant piping : 7.5m, Level differences : 0m

*3) Nominal heating capacities are based on;

- Indoor temperature : 20°C DB, 15°C WB

- Outdoor temperature : 7°C DB, 6°C WB, Equivalent refrigerant piping : 7.5m, Level differences : 0m

*4) Sound pressure was acquired in a dead room. Thus actual noise level may be different depending on the installation conditions.

*5) Specifications may be subject to change without prior notice for product improvement.

Indoor Unit(cont.)

■ Wall Mounted type(Neo Forte without EEV)

Model			AM022FNTDEH/TK	AM028FNTDEH/TK	AM036FNTDEH/TK	AM056FNTDEH/TK	AM071FNTDEH/TK	
Power Supply		ø/V/Hz	1/220~240/50	1/220~240/50	1/220~240/50	1/220~240/50	1/220~240/50	
Mode*1)			HP / HR	HP / HR	HP / HR	HP / HR	HP / HR	
Performance	Capacity	Cooling*2)	kW	2.2	2.8	3.6	5.6	6.8
			Btu/h	7,500	9,500	12,200	19,100	23,200
		Heating*3)	kW	2.5	3.2	4.0	6.3	7.0
			Btu/h	8,500	10,900	13,600	21,400	23,800
Condensate (with High fan speed)		Liters/h	1.12	1.44	1.91	2.87	3.51	
Power	Input	W	25 ^{*5)}	25 ^{*5)}	30 ^{*5)}	45 ^{*5)}	50 ^{*5)}	
	Running Current	A	0.16 ^{*5)}	0.16 ^{*5)}	0.18 ^{*5)}	0.27 ^{*5)}	0.30 ^{*5)}	
Sound Level	Sound Pressure *4)	dB(A)	42	43	43	48	48	
Fan	Type	-	Crossflow fan	Crossflow fan	Crossflow fan	Crossflow fan	Crossflow fan	
	Motor	Model	-	YFK-8-4-SX06	YFK-8-4-SX06	YFK-8-4-SX06	YDK-045S42213-02	YDK-045S42213-02
		Type	-	Resin/steel	Resin/steel	Resin/steel	Resin/steel	Resin/steel
		Output	W	-	-	-	-	-
Airflow Rate	Cooling (High)	m ³ /min	7.80 ^{*5)}	7.80 ^{*5)}	9.30 ^{*5)}	12.00 ^{*5)}	14.00 ^{*5)}	
	Heating (High)	m ³ /min	8.20 ^{*5)}	8.20 ^{*5)}	9.50 ^{*5)}	13.00 ^{*5)}	15.00 ^{*5)}	
Refrigerant	Type	-	R410A	R410A	R410A	R410A	R410A	
	Control Method	-	EEV (Optional)	EEV (Optional)	EEV (Optional)	EEV (Optional)	EEV (Optional)	
Temperature Control	-	Micom&Thermistors	Micom&Thermistors	Micom&Thermistors	Micom&Thermistors	Micom&Thermistors		
Safety Devices	-	Fuse	Fuse	Fuse	Fuse	Fuse		
Piping Connections	Liquid (Flare)	ø, mm	6.35	6.35	6.35	6.35	9.52	
	Gas (Flare)	ø, mm	12.7	12.7	12.7	12.7	15.88	
	Drain	ø, mm	ID 18 hose	ID 18 hose	ID 18 hose	ID 18 hose	ID 18 hose	
Weight	Net Weight	kg	8.0	8.0	8.0	13.0 ^{*5)}	13.0 ^{*5)}	
	Shipping Weight	kg	11.0	11.0	11.0	16.0	16.0	
Dimensions	Net Dimensions (W x H x D)	mm	825x285x189	825x285x189	825x285x189	1,099x315x217	1,099x315x217	
	Shipping Dimensions (W x H x D)	mm	900x349x252	900x349x252	900x349x252	1,137x377x299	1,137x377x299	
Functions	Auto Restart	-	O	O	O	O	O	
	Auto Swing	-	O	O	O	O	O	
	Group/Individual Control	-	O	O	O	O	O	
	External Contact Control	-	O	O	O	O	O	
	Trouble Shooting by LED	-	O	O	O	O	O	
Standard Accessories	Installation Manual	-	O	O	O	O	O	
	Operation Manual	-	O	O	O	O	O	
	Pattern Sheet for Installation	-	X	X	X	X	X	
	Flexible Drain Hose	-	O	O	O	O	O	
	Filter / Safety Grille	-	Filter (Washable)	Filter (Washable)	Filter (Washable)	Filter (Washable)	Filter (Washable)	
Optional Accessories	Wireless Remote Controller	-	ARH-5012	ARH-5012	ARH-5012	ARH-5012	ARH-5012	
	Wireless Remote Controller	-	MR-DH00	MR-DH00	MR-DH00	MR-DH00	MR-DH00	
	Wired Remote Controller	Simplified	-	MWR-WE10N	MWR-WE10N	MWR-WE10N	MWR-WE10N	
	External Contact Interface Module	-	MIM-B14	MIM-B14	MIM-B14	MIM-B14	MIM-B14	
	EEV Kits	-	MXD, MEV Series	MXD, MEV Series	MXD, MEV Series	MXD, MEV Series	MXD, MEV Series	



*1) Mode

- HP : Heat Pump, HR : Heat Recovery

*2) Nominal cooling capacities are based on;

- Indoor temperature : 27°C DB, 19°C WB

- Outdoor temperature : 35°C DB, 24°C WB, Equivalent refrigerant piping : 7.5m, Level differences : 0m

*3) Nominal heating capacities are based on;

- Indoor temperature : 20°C DB, 15°C WB

- Outdoor temperature : 7°C DB, 6°C WB, Equivalent refrigerant piping : 7.5m, Level differences : 0m

*4) Sound pressure was acquired in a dead room. Thus actual noise level may be different depending on the installation conditions.

*5) Specifications may be subject to change without prior notice for product improvement.

Indoor Unit(cont.)

■ Wall Mounted type(Neo Forte with EEV)

Model			AM022FNQDEH/TK	AM028FNQDEH/TK	AM036FNQDEH/TK	
Power Supply		ø/V/Hz	1/220~240/50	1/220~240/50	1/220~240/50	
Mode*1)			HP	HP	HP	
Performance	Capacity	Cooling*2)	kW	2.2	2.8	3.6
			Btu/h	7,500	9,500	12,200
		Heating*3)	kW	2.5	3.2	4.0
			Btu/h	8,500	10,900	13,600
	Condensate (with High fan speed)		Liters/h	1.12	1.44	1.91
Power	Input		W	25 ^{*5)}	25 ^{*5)}	30 ^{*5)}
	Running Current		A	0.16 ^{*5)}	0.16 ^{*5)}	0.18 ^{*5)}
Sound Level	Sound Pressure *4)		dB(A)	43	44	44
Fan	Type		-	Crossflow fan	Crossflow fan	Crossflow fan
	Motor	Model	-	YFK-8-4-SX06	YFK-8-4-SX06	YFK-8-4-SX06
		Type	-	Feedback SSR	Feedback SSR	Feedback SSR
		Output	W	-	-	-
Airflow Rate	Cooling (High)		m ³ /min	7.80 ^{*5)}	7.80 ^{*5)}	9.30 ^{*5)}
	Heating (High)		m ³ /min	8.20 ^{*5)}	8.20 ^{*5)}	9.50 ^{*5)}
Refrigerant	Type		-	R410A	R410A	R410A
	Control Method		-	EEV	EEV	EEV
Temperature Control			-	Micom&Thermistors	Micom&Thermistors	Micom&Thermistors
Safety Devices			-	Fuse	Fuse	Fuse
Piping Connections	Liquid (Flare)		ø, mm	6.35	6.35	6.35
	Gas (Flare)		ø, mm	12.7	12.7	12.7
	Drain		ø, mm	ID 18 hose	ID 18 hose	ID 18 hose
Weight	Net Weight		kg	8.3	8.3	8.3
	Shipping Weight		kg	11.3	11.3	11.3
Dimensions	Net Dimensions (W x H x D)		mm	825x285x189	825x285x189	825x285x189
	Shipping Dimensions (W x H x D)		mm	900x349x252	900x349x252	900x349x252
Functions	Auto Restart		-	O	O	O
	Auto Swing		-	O	O	O
	Group/Individual Control		-	O	O	O
	External Contact Control		-	O	O	O
	Trouble Shooting by LED		-	O	O	O
Standard Accessories	Installation Manual		-	O	O	O
	Operation Manual		-	O	O	O
	Pattern Sheet for Installation		-	X	X	X
	Flexible Drain Hose		-	O	O	O
	Filter / Safety Grille		-	Filter (Washable)	Filter (Washable)	Filter (Washable)
	Wireless Remote Controller		-	ARH-5012	ARH-5012	ARH-5012
Optional Accessories	Wireless Remote Controller		-	MR-DH00	MR-DH00	MR-DH00
	Wired Remote Controller	Simplified	-	MWR-WE10N	MWR-WE10N	MWR-WE10N
		External Contact Interface Module		-	MIM-B14	MIM-B14



*1) Mode

- HP : Heat Pump, HR : Heat Recovery

*2) Nominal cooling capacities are based on;

- Indoor temperature : 27°C DB, 19°C WB

- Outdoor temperature : 35°C DB, 24°C WB, Equivalent refrigerant piping : 7.5m, Level differences : 0m

*3) Nominal heating capacities are based on;

- Indoor temperature : 20°C DB, 15°C WB

- Outdoor temperature : 7°C DB, 6°C WB, Equivalent refrigerant piping : 7.5m, Level differences : 0m

*4) Sound pressure was acquired in a dead room. Thus actual noise level may be different depending on the installation conditions.

*5) Specifications may be subject to change without prior notice for product improvement.

Indoor Unit(cont.)

■ Wall Mounted type(Neo Forte with EEV)

Model			AM045FNQDEH/TK	AM056FNQDEH/TK	AM071FNQDEH/TK	
Power Supply		ø/V/Hz	1/220~240/50	1/220~240/50	1/220~240/50	
Mode*1)			HP	HP	HP	
Performance	Capacity	Cooling*2)	kW	4.5	5.6	6.8
			Btu/h	-	19,100	23,200
		Heating*3)	kW	5.0	6.3	7.0
			Btu/h	-	21,400	23,800
Condensate (with High fan speed)		Liters/h	2.35	2.87	3.51	
Power	Input		W	40 ^{*5)}	45 ^{*5)}	50 ^{*5)}
	Running Current		A	0.24 ^{*5)}	0.27 ^{*5)}	0.30 ^{*5)}
Sound Level	Sound Pressure *4)		dB(A)	49	49	49
Fan	Type		-	Crossflow fan	Crossflow fan	Crossflow fan
	Motor	Model	-	YDK-045S42213-02	YDK-045S42213-02	YDK-045S42213-02
		Type	-	Feedback SSR	Feedback SSR	Feedback SSR
		Output	W	-	-	-
Airflow Rate	Cooling (High)		m ³ /min	11.70 ^{*5)}	13.00 ^{*5)}	14.00 ^{*5)}
	Heating (High)		m ³ /min	12.30 ^{*5)}	13.50 ^{*5)}	15.00 ^{*5)}
Refrigerant	Type		-	R410A	R410A	R410A
	Control Method		-	EEV	EEV	EEV
Temperature Control		-	Micom&Thermistors	Micom&Thermistors	Micom&Thermistors	
Safety Devices		-	Fuse	Fuse	Fuse	
Piping Connections	Liquid (Flare)		ø, mm	6.35	6.35	9.52
	Gas (Flare)		ø, mm	12.7	12.7	15.88
	Drain		ø, mm	ID 18 hose	ID 18 hose	ID 18 hose
Weight	Net Weight		kg	13.5	13.5	13.5
	Shipping Weight		kg	16.5	16.5	16.5
Dimensions	Net Dimensions (W x H x D)		mm	1,099x315x217	1,099x315x217	1,099x315x217
	Shipping Dimensions (W x H x D)		mm	1,137x377x299	1,137x377x299	1,137x377x299
Functions	Auto Restart		-	O	O	O
	Auto Swing		-	O	O	O
	Group/Individual Control		-	O	O	O
	External Contact Control		-	O	O	O
	Trouble Shooting by LED		-	O	O	O
Standard Accessories	Installation Manual		-	O	O	O
	Operation Manual		-	O	O	O
	Pattern Sheet for Installation		-	X	X	X
	Flexible Drain Hose		-	O	O	O
	Filter / Safety Grille		-	Filter (Washable)	Filter (Washable)	Filter (Washable)
	Wireless Remote Controller		-	ARH-5012	ARH-5012	ARH-5012
Optional Accessories	Wireless Remote Controller		-	MR-DH00	MR-DH00	MR-DH00
	Wired Remote Controller	Simplified	-	MWR-WE10N	MWR-WE10N	MWR-WE10N
		External Contact Interface Module		-	MIM-B14	MIM-B14



*1) Mode

- HP : Heat Pump, HR : Heat Recovery

*2) Nominal cooling capacities are based on;

- Indoor temperature : 27°C DB, 19°C WB

- Outdoor temperature : 35°C DB, 24°C WB, Equivalent refrigerant piping : 7.5m, Level differences : 0m

*3) Nominal heating capacities are based on;

- Indoor temperature : 20°C DB, 15°C WB

- Outdoor temperature : 7°C DB, 6°C WB, Equivalent refrigerant piping : 7.5m, Level differences : 0m

*4) Sound pressure was acquired in a dead room. Thus actual noise level may be different depending on the installation conditions.

*5) Specifications may be subject to change without prior notice for product improvement.

Indoor Unit(cont.)

■ Wall Mounted type(A3050 With EEV)

Model			AM015JNVDEH/TK	AM022JNVDEH/TK	AM028JNVDEH/TK	AM036JNVDEH/TK	
Power Supply			Φ,#,V,Hz	1,220~240,50	1,220~240,50	1,220~240,50	1,220~240,50
Mode *1)				HP / HR	HP / HR	HP / HR	HP / HR
Performance	Capacity	Cooling*2)	kW	1.5	2.2	2.8	3.6
			Btu/h	5,115	7,502	9,548	12,276
		Heating*3)	kW	1.7	2.5	3.2	4.0
			Btu/h	5,797	8,525	10,912	13,640
Power	Power Input	Cooling	W	14	15	16	20
		Heating	W	16	18	24	28
	Current Input	Cooling	A	0.12	0.13	0.13	0.15
		Heating	A	0.13	0.15	0.19	0.20
Fan	Motor	Type	-	Crossflow Fan Φ83*L552	Crossflow Fan Φ83*L552	Crossflow Fan Φ83*L552	Crossflow Fan Φ98*L633
		Output	W	27	27	27	27
		Number of unit		1	1	1	1
	Airflow Rate	Cooling(High)	m ³ /mim	4.40	4.50	5.70	7.10
		Heating(High)	m ³ /mim	5.80	6.00	8.50	10.00
Piping Connections	Liquid Pipe		Φ,mm	6.35	6.35	6.35	6.35
			Φ,inch	1/4"	1/4"	1/4"	1/4"
	Gas Pipe		Φ,mm	12.70	12.70	12.70	12.70
			Φ,inch	1/2"	1/2"	1/2"	1/2"
Drain Pipe			Φ,mm	ID 18 HOSE	ID 18 HOSE	ID 18 HOSE	ID 18 HOSE
Field Wiring	Power Source Wire	Below 20m/ over 20m"	mm2	1.5 ~ 2.5	1.5 ~ 2.5	1.5 ~ 2.5	1.5 ~ 2.5
	Transmission Cable		mm2	0.75 ~ 1.50	0.75 ~ 1.50	0.75 ~ 1.50	0.75 ~ 1.50
Refrigerant	Type		-	R410A	R410A	R410A	R410A
	Control Method		-	EEV INCLUDED	EEV INCLUDED	EEV INCLUDED	EEV INCLUDED
Sound	Sound Pressure*4)	High/Mid/Low	dBA	28/25/24	33/29/25	36/31/26	37/33/29
Dimensions	Net Weight		kg	8.3	8.3	8.3	10.0
	Shipping Weight		kg	9.7	9.7	9.7	11.8
	Net Dimensions (W x H x D)		mm	750*250*245	750*250*245	750*250*245	826*275*260
	Shipping Dimensions (W x H x D)		mm	800*298*302	800*298*302	800*298*302	886*335*317
Functions	Auto Restart		-	O	O	O	O
	Auto Swing		-	O	O	O	O
	Group/Individual Control		-	O	O	O	O
	External Contact Control		-	O	O	O	O
	Trouble Shooting by LED		-	O	O	O	O
Standard Accessories	Installation Manual		-	O	O	O	O
	Operation Manual		-	O	O	O	O
	Pattern Sheet for Installation		-	X	X	X	X
	Flexible Drain Hose		-	O	O	O	O
	Filter / Safety Grille		-	Filter (Washable)	Filter (Washable)	Filter (Washable)	Filter (Washable)
	Wireless Remote Controller		-	MR-EH00	MR-EH00	MR-EH00	MR-EH00
Optional Accessories	Wireless Remote Controller		-	-	-	-	-
	Wired Remote Controller	Simplified	-	MWR-WE10N	MWR-WE10N	MWR-WE10N	MWR-WE10N
	External Contact Interface Module		-	MIM-B14	MIM-B14	MIM-B14	MIM-B14



*1) Mode

- HP : Heat Pump, HR : Heat Recovery

*2) Nominal cooling capacities are based on;

- Indoor temperature : 27°C DB, 19°C WB

- Outdoor temperature : 35°C DB, 24°C WB, Equivalent refrigerant piping : 7.5m, Level differences : 0m

*3) Nominal heating capacities are based on;

- Indoor temperature : 20°C DB, 15°C WB

- Outdoor temperature : 7°C DB, 6°C WB, Equivalent refrigerant piping : 7.5m, Level differences : 0m

*4) Sound pressure was acquired in a dead room. Thus actual noise level may be different depending on the installation conditions.

*5) Specifications may be subject to change without prior notice for product improvement.

Indoor Unit(cont.)

■ Wall Mounted type(A3050 With EEV)

Model			AM045JNVDEH/TK	AM056JNVDEH/TK	AM071JNVDKH/TK	AM082JNVDEH/TK	
Power Supply			Φ,#,V,Hz	1,220~240,50	1,220~240,50	1,220~240,50	
Mode *1)				HP / HR	HP / HR	HP / HR	
Performance	Capacity	Cooling*2)	kW	4.5	5.6	7.1	8.2
			Btu/h	15,345	19,096	24,211	27,962
		Heating*3)	kW	5.0	6.3	8.0	8.5
			Btu/h	17,050	21,483	27,280	28,985
Power	Power Input	Cooling	W	31	27	41	55
		Heating	W	41	37	53	72
	Current Input	Cooling	A	0.24	0.21	0.31	0.42
		Heating	A	0.31	0.29	0.41	0.55
Fan	Motor	Type	-	Crossflow Fan Φ98*L633	Crossflow Fan Φ106*L830	Crossflow Fan Φ106*L830	Crossflow Fan Φ106*L830
		Output	W	27	27	27	27
		Number of unit		1	1	1	1
	Airflow Rate	Cooling(High)	m ³ /mim	9.30	11.80	14.80	17.30
		Heating(High)	m ³ /mim	12.60	15.00	18.00	20.40
Piping Connections	Liquid Pipe		Φ,mm	6.35	6.35	9.52	9.52
			Φ,inch	1/4"	1/4"	3/8"	3/8"
	Gas Pipe		Φ,mm	12.70	12.70	15.88	15.88
			Φ,inch	1/2"	1/2"	5/8"	5/8"
Drain Pipe		Φ,mm	ID 18 HOSE	ID 18 HOSE	ID 18 HOSE	ID 18 HOSE	
Field Wiring	Power Source Wire	Below 20m/ over 20m"	mm2	1.5 ~ 2.5	1.5 ~ 2.5	1.5 ~ 2.5	1.5 ~ 2.5
	Transmission Cable		mm2	0.75 ~ 1.50	0.75 ~ 1.50	0.75 ~ 1.50	0.75 ~ 1.50
Refrigerant	Type		-	R410A	R410A	R410A	R410A
	Control Method		-	EEV INCLUDED	EEV INCLUDED	EEV INCLUDED	EEV INCLUDED
Sound	Sound Pressure*4)	High/Mid/Low	dBa	42/38/35	39/36/33	44/41/36	47/44/41
Dimensions	Net Weight		kg	10.0	14.5	14.5	14.6
	Shipping Weight		kg	11.8	17.5	17.5	16.6
	Net Dimensions (W x H x D)		mm	826*275*260	1063*317*294	1063*317*294	1063*317*294
	Shipping Dimensions (W x H x D)		mm	886*335*317	1123*384*354	1123*384*354	1123*384*354
Functions	Auto Restart		-	O	O	O	O
	Auto Swing		-	O	O	O	O
	Group/Individual Control		-	O	O	O	O
	External Contact Control		-	O	O	O	O
	Trouble Shooting by LED		-	O	O	O	O
Standard Accessories	Installation Manual		-	O	O	O	O
	Operation Manual		-	O	O	O	O
	Pattern Sheet for Installation		-	X	X	X	X
	Flexible Drain Hose		-	O	O	O	O
	Filter / Safety Grille		-	Filter (Washable)	Filter (Washable)	Filter (Washable)	Filter (Washable)
Optional Accessories	Wireless Remote Controller		-	MR-EH00	MR-EH00	MR-EH00	MR-EH00
	Wired Remote Controller	Simplified	-	MWR-WE10N	MWR-WE10N	MWR-WE10N	MWR-WE10N
		External Contact Interface Module	-	MIM-B14	MIM-B14	MIM-B14	MIM-B14



*1) Mode

- HP : Heat Pump, HR : Heat Recovery

*2) Nominal cooling capacities are based on;

- Indoor temperature : 27°C DB, 19°C WB

- Outdoor temperature : 35°C DB, 24°C WB, Equivalent refrigerant piping : 7.5m, Level differences : 0m

*3) Nominal heating capacities are based on;

- Indoor temperature : 20°C DB, 15°C WB

- Outdoor temperature : 7°C DB, 6°C WB, Equivalent refrigerant piping : 7.5m, Level differences : 0m

*4) Sound pressure was acquired in a dead room. Thus actual noise level may be different depending on the installation conditions.

*5) Specifications may be subject to change without prior notice for product improvement.

Indoor Unit(cont.)

■ Floor Standing Type

Model			AM036FNFDEH/TK	AM056FNFDEH/TK	AM071FNFDEH/TK	
Power Supply			Ø,V,Hz	220 - 240 V~ 50Hz	220 - 240 V~ 50Hz	220 - 240 V~ 50Hz
Mode				HP / HR	HP / HR	HP / HR
Performance	Capacity	Cooling	kW	3.6	5.6	7.1
			Btu/h	12,200	19,100	24,200
		Heating	kW	4.0	6.3	8.0
			Btu/h	13,600	21,400	27,200
Power	Running Current	Cooling	A	0.24 ^{*5)}	0.53 ^{*5)}	0.53 ^{*5)}
		Heating	A	0.24 ^{*5)}	0.53 ^{*5)}	0.53 ^{*5)}
	Input	Cooling	W	50.0 ^{*5)}	110.0 ^{*5)}	110.0 ^{*5)}
		Heating	W	50.0 ^{*5)}	110.0 ^{*5)}	110.0 ^{*5)}
Sound Level	Sound Pressure		dB	43.0	45.0	45.0
FAN	Type		-	Sirocco	Sirocco	Sirocco
	Motor	Model	-	OS-KRD306(KR035)	OS-KRD306A(KR045)	OS-KRD306A(KR045)
Airflow Rate	Cooling(High)		m ³ /min	10.0 ^{*5)}	16.5 ^{*5)}	16.5 ^{*5)}
	Heating(High)		m ³ /min	11.0 ^{*5)}	19.0 ^{*5)}	19.0 ^{*5)}
Refrigerant	Type		-	R410	R410	R410
	Control Method		-	EEV	EEV	EEV
Temperature Control			-	Micom & Thermistors	Micom & Thermistors	Micom & Thermistors
Safety Devices			-	Fuse	Fuse	Fuse
Piping connections	Liquid(Flare)		Ø,mm	6.35	6.35	9.52
	Gas(Flare)		Ø,mm	12.70	12.70	15.88
	Drain		Ø,mm	ID18 HOSE	ID18 HOSE	ID18 HOSE
Weight	Net Weight		kg	23.0	28.5	28.5
	Shipping Weight		kg	27.0	33.3	33.3
Dimensions	Net Dimensions		mm	945x600x220	1225x600x220	1225x600x220
	Shipping Dimensions		mm	1035x690x310	1335x690x310	1335x690x310
Functions	Auto Restart		-	O	O	O
	Auto Swing		-	X	X	X
	Group/Individual Control		-	O	O	O
	External Contact Control		-	O	O	O
	Trouble Shooting by LED		-	O	O	O
Standard Accessories	Installation Manual		-	O	O	O
	Operation Manual		-	X	X	X
	Pattern Sheet for Installation		-	X	X	X
	Flexible Drain Hose		-	O	O	O
	Filter / Safety Grille		-	O	O	O
	Drain Pump (Pumping, Speed, Lift)		ℓ/h,mm	X	X	X
Optional Accessories	Wireless Remote Controller		-	X	X	X
	Wired Remote Controller		-	MWR-WE10N	MWR-WE10N	MWR-WE10N
	External Contact Interface Module		-	X	X	X



*1) Mode

- HP : Heat Pump, HR : Heat Recovery

*2) Nominal cooling capacities are based on;

- Indoor temperature : 27°C DB, 19°C WB

- Outdoor temperature : 35°C DB, 24°C WB, Equivalent refrigerant piping : 7.5m, Level differences : 0m

*3) Nominal heating capacities are based on;

- Indoor temperature : 20°C DB, 15°C WB



- Outdoor temperature : 7°C DB, 6°C WB, Equivalent refrigerant piping : 7.5m, Level differences : 0m

*4) Sound pressure was acquired in a dead room. Thus actual noise level may be different depending on the installation conditions.

*5) Specifications may be subject to change without prior notice for product improvement.

Indoor Unit(cont.)

■ ERV Plus

Item			Development Model		
			AM050FNKDEH/TK	AM100FNKDEH/TK	
Image	Product				
	Remote Controller		 MWR-WE10N		
Power Source Application	V/Hz/ø	220-240/50/1			
Function	Ventilation	HEAT-EX, BY-PASS, AUTO			
	Heating/Cooling	HEATING, COOLING, AUTO			
	Fan Speed	Turbo, High, Low, Quiet			
Performance	Air Volume	(m ³ /h)	500	1,000	
	External Static Pressure	(Pa)	160	150	
	Power Consumption	(W)	220	510	
	Temperature Exchange Rate	Cooling	(%)	70	70
		Heating	(%)	75	75
	Enthalpy Exchange Rate	Cooling	(%)	60	62
		Heating	(%)	73	75
	Cooling Capacity *():The heat reclaimed from the ERV	(kW)	5.1(1.5)	10.5(3.4)	
Heating Capacity *():The heat reclaimed from the ERV	(kW)	6.5(2.5)	13.2(5.2)		
Humidifier Capacity(Optional Kit)	(kg/h)	2.7	5.4		
Piping Connections	Liquid	Φ,mm	φ6.4 C1220T (Flare Connection)		
	Gas	Φ,mm	φ12.7 C1220T (Flare Connection)		
	Water Supply	mm	1/2 inch		
	Drain	mm	VP25		
Set Size	Weight	kg	61	90	
	Dimensions (WxHxD)	mm	1,553x270x1,000	1,763x340x1,135	
Operating Temp. Range	Around Unit	-	0~40°C DB, 80%RH ↓		
	OA	-	-15~40°C DB, 80%RH ↓		
	RA	-	0~40°C DB, 80%RH ↓		

*** Specifications may be subject to change without prior notice for product improvement.**

- *1) Nominal cooling capacities are based on;
- Indoor temperature : 27°C DB, 19°C WB - Outdoor temperature : 35°C DB, 24°C WB, Equivalent refrigerant piping : 7.5m, Level differences : 0m
- *2) Nominal heating capacities are based on;
- Indoor temperature : 20°C DB, 15°C WB
- Outdoor temperature : 7°C DB, 6°C WB, Equivalent refrigerant piping : 7.5m, Level differences : 0m
- *3) Humidifying capacity is based on;
- Indoor temperature : 20°C DB, 15°C WB
- Outdoor temperature : 7°C DB, 6°C WB, Equivalent refrigerant piping : 7.5m, Level differences : 0m
- *4) Sound pressure was acquired in an anechoic room.
Thus actual noise level may be different depending on the installation conditions.
- *5) OA: fresh air from outdoor. RA: return air from room.

Indoor Unit(cont.)

■ GD-S(Big Duct)

Model			AM180JNHPKH/TK	AM224JNHPKH/TK	
Power Supply		ø/V/Hz	1/220-240/50	1/220-240/50	
Mode*1)			HP / HR	HP / HR	
Performance	Capacity	Cooling*2)	kW	18.0	22.4
			Btu/h	61,400	76,400
	Heating*3)	kW	20.0	25.0	
		Btu/h	54,300	67,600	
Condensate (with High fan speed)		Liters/h	-	-	
Power	Input	W	340	530	
	Running Current	A	1.9	2.9	
Sound Level	Sound Pressure (High/Low)*4)	dB(A)	42	44	
Fan	Type		-	Sirocco Fan	Sirocco Fan
	Motor	Model	-	DL-17860SSBA	DL-17860SSBA
		Type	-	BLDC	BLDC
		Output	W		
Airflow Rate	High/Mid/Low	m ³ /min	58/50/43	72/61/50	
	External Static Pressure	Standard(Min~Max)	mmH ₂ O	7.34(5-20)	7.34(5-20)
Refrigerant	Type		-	R410A	R410A
	Control Method		-	EEV	EEV
Temperature Control		-	Micom&Thermistors	Micom&Thermistors	
Safety Devices		-	Fuse	Fuse	
Piping Connections	Liquid (Flare)		ø, mm	9.52	9.52
	Gas (Flare)		ø, mm	19.05	19.05
	Drain		ø, mm	VP25(OD25, ID20)	VP25(OD25, ID20)
Weight	Net Weight		kg	82.5	82.5
	Shipping Weight		kg	92	92
Dimensions	Net Dimensions (W x H x D)		mm	1350 x 910 x 450	1350 x 910 x 450
	Shipping Dimensions (W x H x D)		mm	1612 x 984 x 519	1612 x 984 x 519
Functions	Auto Restart		-	O	O
	Auto Swing		-	X	X
	Group/Individual Control		-	O	O
	External Contact Control		-	O	O
	Trouble Shooting by LED		-	X	X
Standard Accessories	Installation Manual		-	O	O
	Operation Manual		-	O	O
	Pattern Sheet for Installation		-	O	O
	Flexible Drain Hose		-	O	O
	Filter / Safety Grille		-	X	X
Optional Accessories	Wireless Remote Controller		-	MR-DH00	MR-DH00
	Duct Receiver Kits	Receiver	-	MRK-A10	MRK-A10
		Receiver Wire	-	MRW-10A	MRW-10A
	Wired Remote Controller	Simplified	-	MWR-WE10N	MWR-WE10N
	External Contact Interface Module		-	MIM-B14	MIM-B14
	Drain Pump			-	MDP-G075SQ (Internal installation)
		-	MDP-G075SP (External installation)	MDP-G075SP (External installation)	



*1) Mode

- HP : Heat Pump, HR : Heat Recovery

*2) Nominal cooling capacities are based on;

- Indoor temperature : 27°C DB, 19°C WB

- Outdoor temperature : 35°C DB, 24°C WB, Equivalent refrigerant piping : 7.5m, Level differences : 0m

*3) Nominal heating capacities are based on;

- Indoor temperature : 20°C DB, 15°C WB



















- Outdoor temperature : 7°C DB, 6°C WB, Equivalent refrigerant piping : 7.5m, Level differences : 0m

*4) Sound pressure was acquired in a dead room. Thus actual noise level may be different depending on the installation conditions.









*5) Specifications may be subject to change without prior notice for product improvement.



















2-2 Accessory and Option Specifications

2-2-1 Accessories

Classification		Product	Model	Image	Application model
Integrated management system	Controller	DMS 2	MIM-D00AN		DVM Series, FJM, CAC, ERV Hydro unit, Hydro unit HT
		S-NET 3	MST-P3P		DVM Series, FJM, CAC, ERV Hydro unit, Hydro unit HT
	Interface Module	SIM MIM-	MIM-B12N		DVM Series, FJM
Centralized control system	Controller	Centralized controller	MCM-A202DN		DVM Series, FJM, CAC, ERV Hydro unit, Hydro unit HT
		Operation mode selection switch	MCM-C200		DVM Series (Except HR models)
		New touch CONTROLLER	MCM-A300N		
Individual control system ControllerController	Wireless remote controller	MR-DH00			Cassette, Duct (Receiver needed)
		MR-EH00			Cassette, Duct (Receiver needed)
		MR-KH00			360 cassette
	Wired remote controller (Multi function)	MWR-WE10N			Cassette, Wall-mounted, Ceiling, Duct, Console, ERV
	Wired remote controller (Multi function)	MWR-WW00N			Hydro unit / Hydro unit HT
	Wireless signal receiver	MRK-A10			Duct (For wireless remote controller)
	Remote sensor	MRW-TA			Cassette, Wall-mounted, Ceiling, Duct, Console
	ERV CO2 Sensor	MOS-C1			ERV, ERV PLUS
Building management system	Lonworks interface module	MIM-B18N			DVM Series, FJM, CAC, ERV
	DMS-Bnet (BACnet)	MIM-B17N			DVM Series, FJM Hydro unit, Hydro unit HT
Guest room management system	External contact interface module	MIM-B14			Mini DVM(R-410A), DVM PLUS III, FJM
Power distribution			MIM-B16N		DVM Series, FJM
Converter			MIM-C02N		DVM Series, FJM, CAC
			MIM-N00		
Multi Tenant Function Controller			MCM-C210		







※ DVM Series : DVM mini, DVM PLUS III, DVM PLUS III HR, DVM PLUS IV, DVM PLUS IV HR

Classification	Feature	Model	Description	Relevant unit	Remark
Y-JOINT		MXJ-YA1509M	15.0 kW and below	DVMS HP / HR	Requisite
		MXJ-YA2512M	Over 15.0 ~ 40.6 kW and below		
		MXJ-YA2812M	Over 40.6 ~ 46.4 kW and below		
		MXJ-YA2815M	Over 46.4 ~ 69.6 kW and below		
		MXJ-YA3419M	Over 69.6 ~ 98.6 kW and below		
		MXJ-YA4119M	Over 98.6 ~ 139.2 kW and below		
		MXJ-YA4422M	Over 139.2 kW		
Y-joint(High Pressure Gas) for DVM S HR		MXJ-YA1500M	23.2 kW and below	DVMS HR	Requisite
		MXJ-YA2500M	Over 23.2 ~ 69.6 kW and below		
		MXJ-YA3100M	Over 69.6 ~ 139.2 kW and below		
		MXJ-YA3800M	Over 139.2 kW		
Outdoor joint (Outdoor Connection)		MXJ-TA3819M	Below 48 HP	DVMS HP / HR	Requisite
		MXJ-TA4422M	Over 50 HP		
Outdoor joint (High Pressure Gas) for DVM S HR		MXJ-TA3100M	Below 48 HP	DVMS HR	Requisite
		MXJ-TA3800M	Over 50 HP		
Header joint		MXJ-HA2512M	Below 46.4 kW	DVMS HP / HR	Requisite
		MXJ-HA3115M	Below 69.6 kW		
		MXJ-HA3819M	Over 69.7 kW		
EEV kits		MXD-E13K116A	Below 3.6 kW (1 Room) + 5.6 kW ~9.0 kW (1Room)	Wall-mounted & Ceiling indoor unit (For 2 indoor units)	Option
		MXD-E13K200A	Below 3.6 kW (2 Rooms)		
		MXD-E16K200A	5.6 kW~9.0 kW (2Rooms)		
		MXD-E22K200A	Over 9.0 kW (2Rooms)		
		MXD-E13K216A	Below 3.6 kW (2 Rooms) + 5.6 kW ~9.0 kW (1Room)	Wall-mounted & Ceiling indoor unit (For 3 indoor units)	
		MXD-E13K300A	Below 3.6 kW (3 Rooms)		
		MXD-E16K213A	Below 3.6 kW (1 Room) + 5.6 kW ~9.0 kW (2Rooms)		
		MXD-E16K300A	5.6 kW ~ 9.0 kW (3Rooms)		
		MEV-E13SA	Below 3.6 kW (1 Room)	Wall-mounted & Ceiling indoor unit (for single unit)	
		MEV-E16SA	5.6 kW ~ 9.0 kW (1Room)		
Drain Pump		MDP-N047SNC1D	HSP Duct 22.0/28.0kW	-	Option
			MDP-M075SGU1D	MSP Duct (9.0/11.2) kW	
	MDP-M075SGU2D		MSP Duct (12.8/14.0) kW HSP Duct (11.2/12.8/14.0) kW		
	MDP-M075SGU3D		MSP Duct (5.6/7.1) kW		
		MDP-E075SEE3D	SlimDuct (1.7~14.0) kW	-	
			MDP-G075SQ (Internal installation)	Global Duct GD-S Big Duct	
	MDP-G075SP (External installation)		-		

Classification	Feature	Model	Description	Relevant unit	Remark
MCU		MCU-S4NEE1N	Below 4 indoor units	DVMS HR	Requisite (HR Only)
		MCU-S6NEE1N	Below 2 large capacity ducts		
		MCU-S4NEE2N	Below 6 indoor units		
AHU KIT		MXD-K025AN	7.0kW~8.75kW	-	Option
		MXD-K050AN	14.0kW~17.5kW		
		MXD-K075AN	21.0kW~26.25kW		
		MXD-K100AN	28.0kW~35.0kW		
PDM KIT		MXD-A38K2A	8~12HP	DVMS	Option
		MXD-A58K2A	14~22HP		
Humidifier		MVO-VA050100	500CMH	-	Option
		MVO-VA100100	1000CMH		
S-Plasma Ion KIT		MSD-CAN1	4way Cassette	-	Option
		MSD-EAN1	ERV-Plus		
Motion detect sensor		MCR-SMA	4way Cassette	-	Option
Front panel		PC1MWSKAN	Slim 1way cassette	-	Requisite
		PC1NWSMAN	Slim 1way cassette		
		PC1BWSMAN	Slim 1way cassette		
		PC1NUSMAN	Slim 1way cassette		
		PC1NUPMAN	Slim 1way cassette		
		PC2NUSMEN	2 way cassette		
		PC4SUSMAN	Mini 4way cassette		
		PC4SYSMEN	Mini 4way cassette		
		PC4NUSKAN	4 way cassette		
		PC4NUSKEN	4 way cassette		
		PC4NBSKAN	4 way cassette		
		PC4NUDMAN	360 cassette		
		PC4NUNMAN	360 cassette		





3. Disassembly and Reassembly

■ Necessary Tools

Item	Remark
+Screw Driver	
Monkey Spanner	
-Screw Driver	
Nipper	
Electric Motion Driver	
L-Wrench	

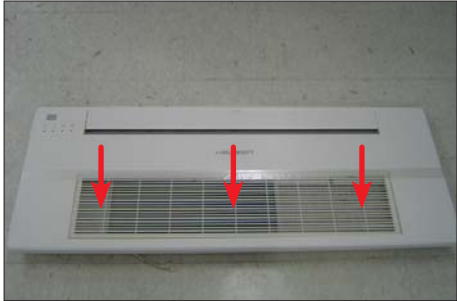
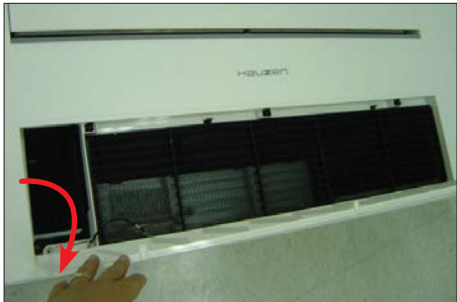

3-1 Indoor Unit



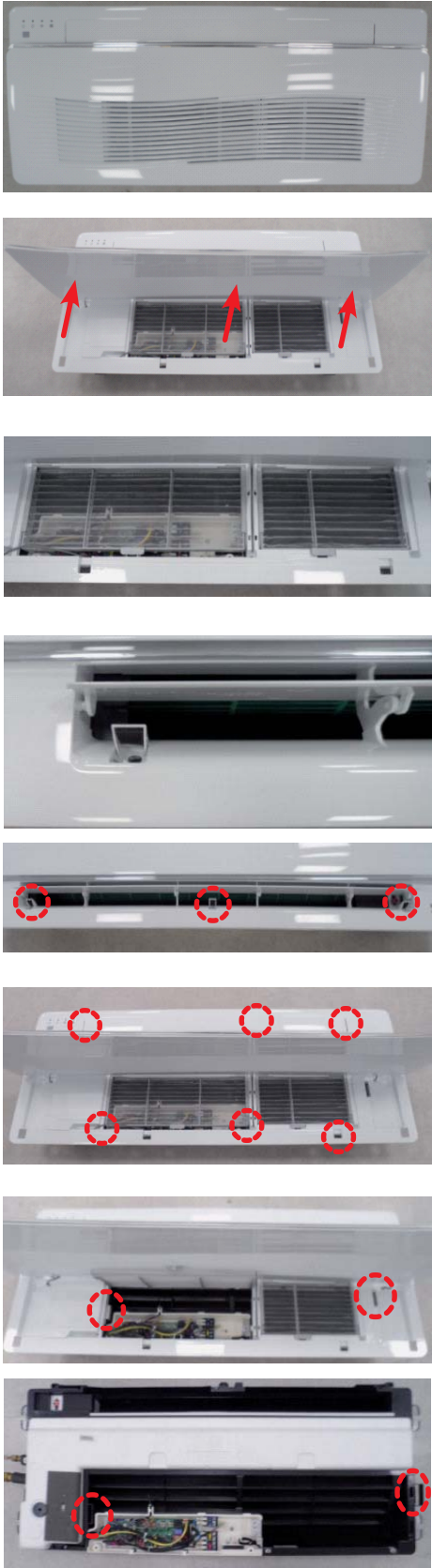

■ Slim 1 way cassette type (medium)

No	Parts	Procedure	Remark
1	Panel & Filter (A type)	<ol style="list-style-type: none"> 1) Press the Push Button on the Grill and open it 2) Separate 1 clip from the Panel and tilt the Grill to 45° and separate the Grille from the Panel. 3) Separate the Filter from the Panel. 4) Separate 3 cover screws from it. 5) Unscrew 6 fixed screws and separate them from the Indoor Unit. (Use +Screw Driver) 	    

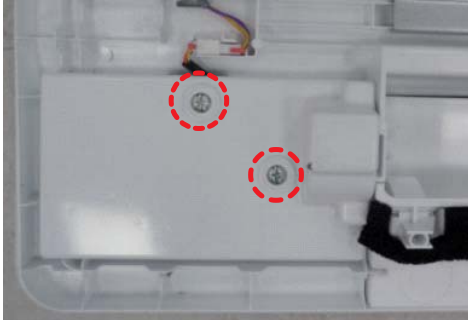
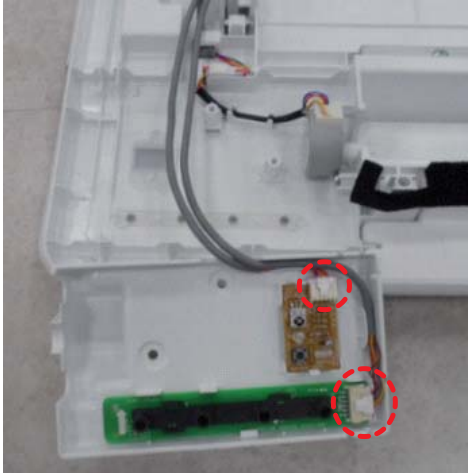



No	Parts	Procedure	Remark
		6) Press the left and right Hooks to separate the Panel from the Indoor Unit.	

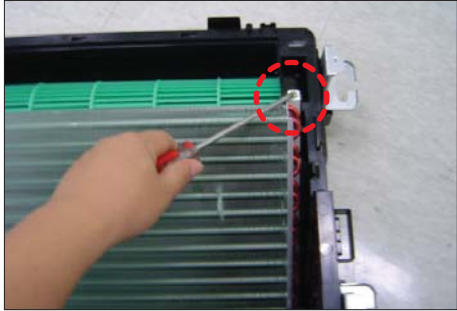
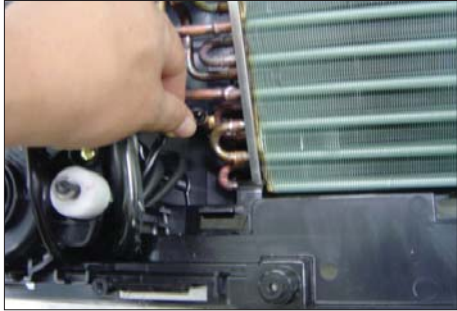

No	Parts	Procedure	Remark
1	<p>PANEL & FILTER</p> <p>INTERIOR TYPE (PC1NWSMAN PC1BWSMAN)</p>	<p>1) Open the GRILLE, as shown in the picture.</p> <p>2) Separate the FILTER from the PANEL.</p> <p>3) Remove the 2 COVER SCREW.</p> <p>4) Remove the 5 screws fixed in PANEL and then separate from the indoor unit. (Use +Screw Driver)</p> <p>5) Press the left and right side HOOK of PANEL and then separate the PANEL from the indoor unit.</p>	

No	Parts	Procedure	Remark
	<p>PANEL & FILTER (cont.)</p>	<p>6) Open the GRILLE and then raise the LINK LEVER SWITCH (yellowish green) of left and right in the direction of arrow and then separate the LINK LEVER.</p> <p>7) Remove the fixing screws from the COVER DISPLAY using electric motion driver and separate it.</p> <p>8) Disconnect the connectors of remote control receiver PBA / display PBA.</p>	    

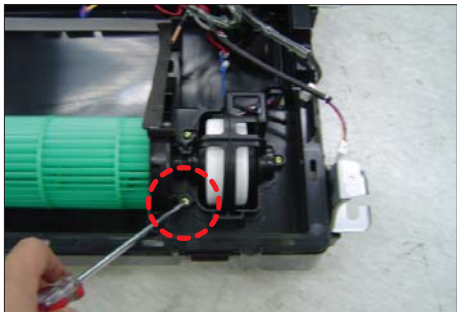

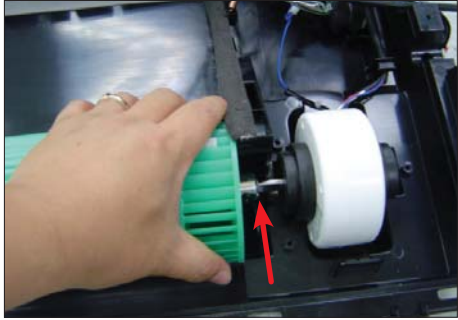
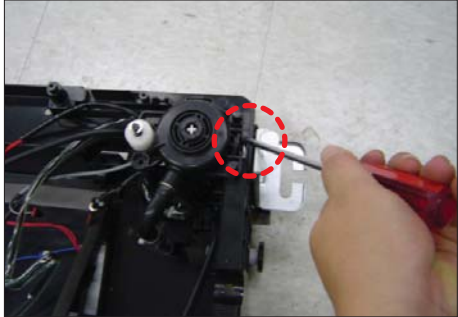

No	Parts	Procedure	Remark
2	Drain Pan	1) Separate 5 fixing screws from the Drain Pan. (Use +Screw Driver) 2) Pull the Drain Pan to separate them from the Indoor Unit. ⚠ When disassembling the Pan, be careful not to touch the heat exchanger board with a bare hand.	 
3	Control In	1) Undo 3 fixing screws in the Control In appliance part to separate the Cover. (Use +Screw Driver)	 

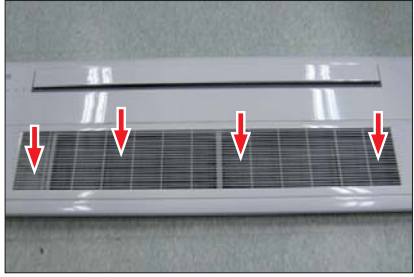

No	Parts	Procedure	Remark
		<p>2) Separate 8 connectors on the PCB of the Indoor Unit.</p> <p>3) Separate the Control In from the Indoor Unit.</p>	  
4	Drain Sub	1) Push the hook on the Drain Sub to separate it.	 

No	Parts	Procedure	Remark
5	Heat Exchanger	<ol style="list-style-type: none"> 1) Undo fixing screw in the Heat Exchanger. (Use +Screw Driver) 2) Separate an Indoor Sensor from the Heat Exchanger. 3) Separate the Heat Exchanger from the Indoor Unit. 	  
6	Cross Fan	<ol style="list-style-type: none"> 1) Undo 3 fixing screws on the Cover Fan Motor. (Use +Screw Driver) 2) Separate the Cover Fan Motor from the Indoor Unit. 	 

No	Parts	Procedure	Remark
		<p>3) Separate the Cross Fan from the Indoor Unit.</p>	
7	Drain Pump	<p>1) Separate fixing screw in the Cover Drain Pump. (Use +Screw Driver)</p> <p>2) Separate the Drain Hose from the Drain Pump.</p> <p>3) Separate the Drain Pump from the Indoor Unit.</p>	  



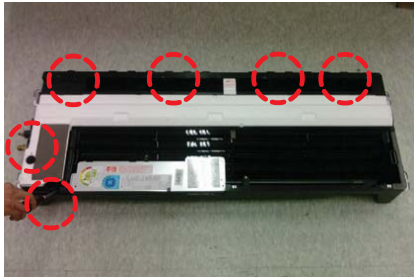
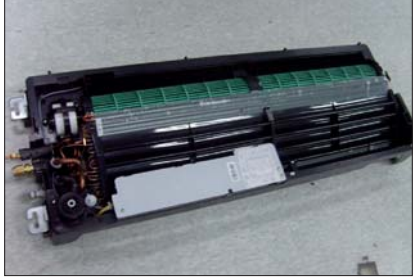
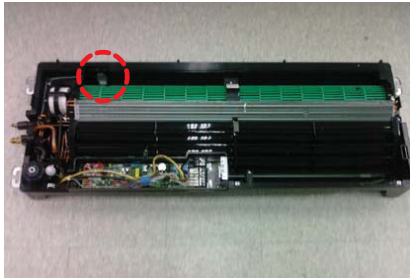

■ Slim 1 way cassette type (large)

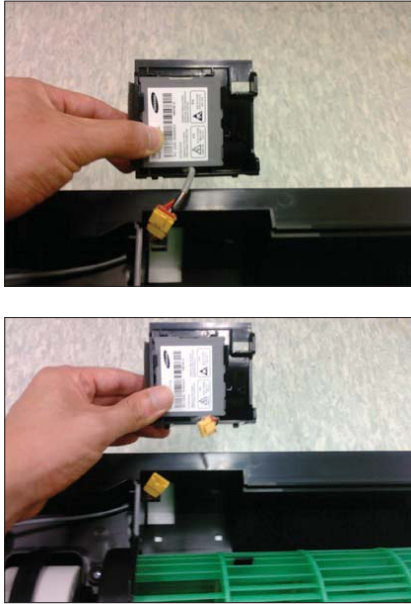
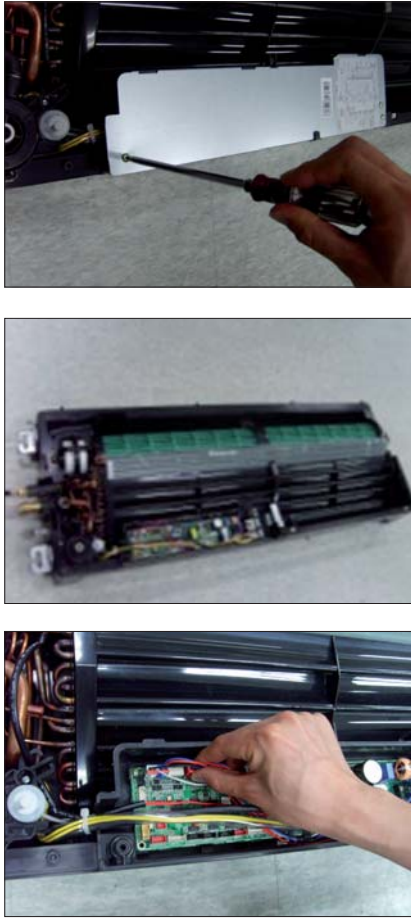

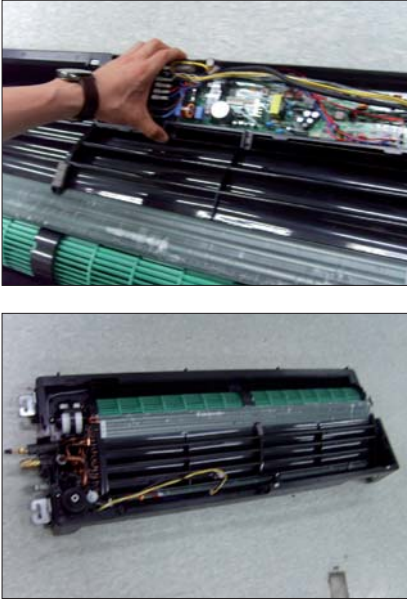
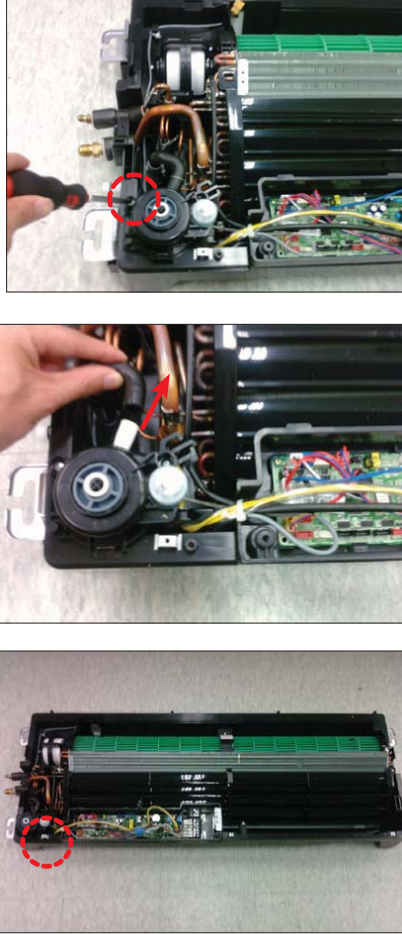
No	Parts	Procedure	Remark
1	PANEL & FILTER	<p>1) Press the PUSH BUTTON and open the GRILL.</p> <p>2) First, remove the clip from the PANEL. And then incline the GRILLE by 90° and separate the GRILLE from the PANEL.</p> <p>3) Separate the FILTER from the PANEL.</p> <p>4) Remove the 4 COVER SCREW.</p> <p>5) Remove the 7 screws fixed in PANEL and then separate from the indoor unit. (Use +Screw Driver)</p>	    

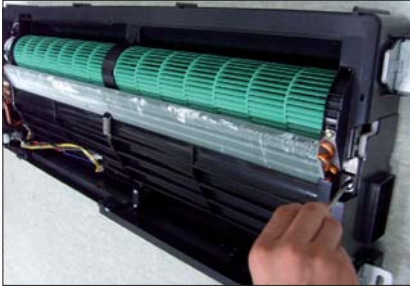

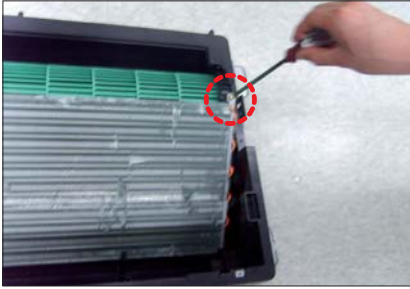
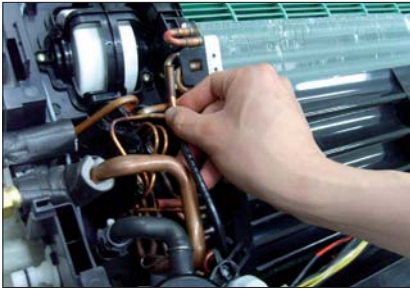
No	Parts	Procedure	Remark
		1) Press the left and right side HOOK of PANEL and then separate the PANEL from the indoor unit.	
2	DRAIN PAN	1) Remove the 6 screws fixed in DRAIN PAN. (Use +Screw Driver) 2) Remove the 2 HOOK fixed in DRAIN PAN and then separate from the indoor unit. ⚠ When disassembling the PAN, be careful not to touch the heat exchanger board with a bare hand.	 
3	SPI-KIT (Option)	1) Remove the SPI KIT from the indoor unit, as shown in the picture.	 

No	Parts	Procedure	Remark
			
4	Electrical equipment parts	<p>1) Remove the 3 screws fixed in electrical equipment parts and then separate the COVER. (Use +Screw Driver)</p> <p>2) Separate the 8 connectors from the indoor unit PCB, as shown in the picture.</p> <p>⚠ Turn off the power necessarily in case of contact pan area. Be careful, it may cause injury on the sharp sides of the pan.</p>	

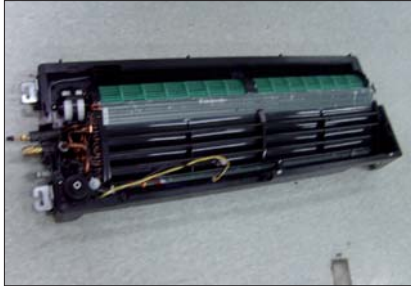

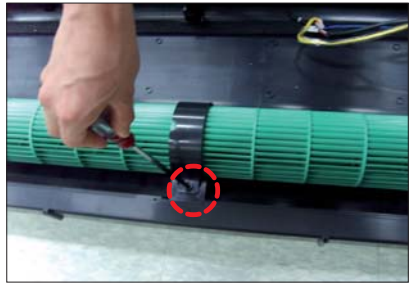

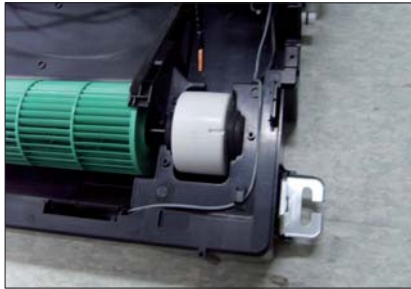
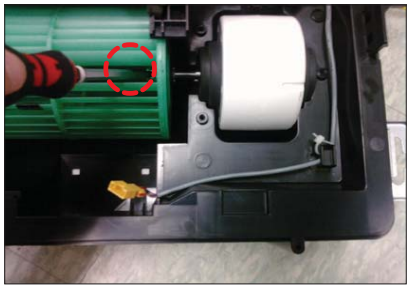
No	Parts	Procedure	Remark
		<p>3) Separate the electrical equipment parts from the indoor unit.</p>	
5	DRAIN PUMP	<p>1) Remove the 3 screws fixed in COVER DRAIN PUMP. (Use +Screw Driver)</p> <p>2) First, loosen the BAND RING. And then separate the DRAIN HOSE from the DRAIN PUMP.</p> <p>3) Separate the DRAIN PUMP from the indoor unit.</p>	

No	Parts	Procedure	Remark
6	DRAIN SUB	1) Remove the screw fixed in DRAIN SUB. (Use +Screw Driver) 2) Hold the HOOK of DRAIN SUB and separate it.	 
7	Heat Exchanger	1) Remove the screw fixed in Heat Exchanger. (Use +Screw Driver) 2) Separate the indoor unit SENSOR from the Heat Exchanger. 3) Separate the EEV connector from the PCB.	  

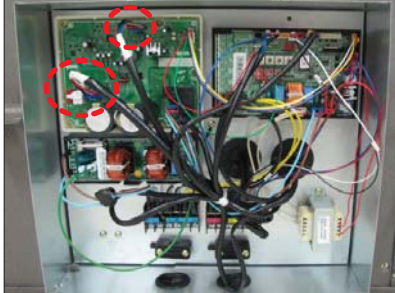
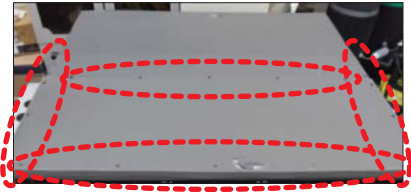
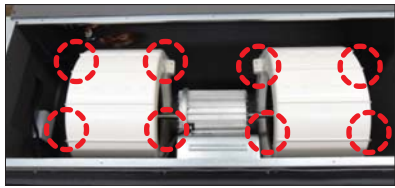

No	Parts	Procedure	Remark
		<p>4) Separate the Heat Exchanger from the indoor unit.</p> <p>5) Separate the EXPANSION COIL from the EEV BODY. (When servicing the EEV)</p>	 
5	DRAIN PUMP	<p>1) Remove the 3 screws fixed in COVER FAN MOTOR. (Use +Screw Driver)</p> <p>2) Remove the screw fixed in HOLDER FAN. (Use +Screw Driver)</p> <p>⚠ If the reassembly, end surface of HOLDER FAN and surface of ASSY CROSS FAN_L should be consistent.</p>	 

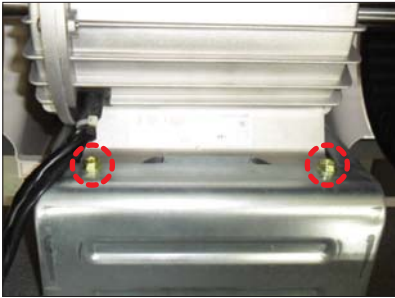
No	Parts	Procedure	Remark
		<p>3) Separate the COVER FAN MOTOR from the indoor unit.</p> <p>4) Remove the screw fixed in CROSS FAN. (Use +Screw Driver)</p> <p>5) Separate the CROSS FAN from the indoor unit.</p>	  

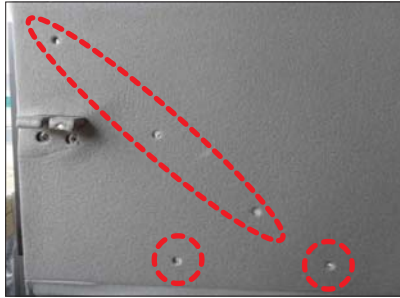

■ BIG DUCT

No	Parts	Procedure	Remark
1	MOTOR & BLOWER	<p>1) Detach the motor connectors from the PCB.</p> <p>2) Unscrew 16 screws and detach Cabinet-Base Blower. (Use+Screw Driver)</p> <p>3) Unscrew 8 screws and detach Case-Blower. (Use +Screw Driver)</p> <p>4) Unscrew 4 bolts and separate Motor & blower from Bracket-Motor. (Use +Screw Driver)</p>	     



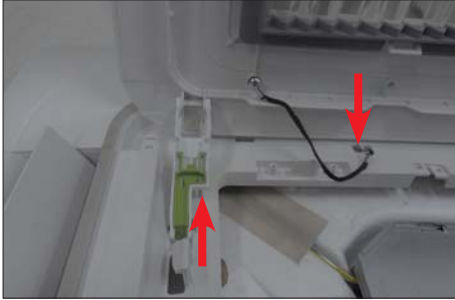
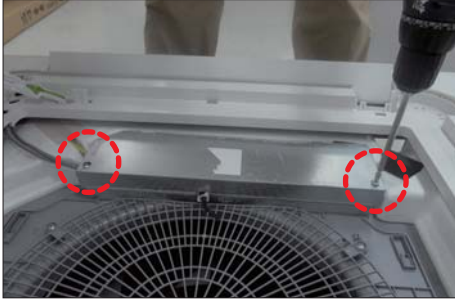
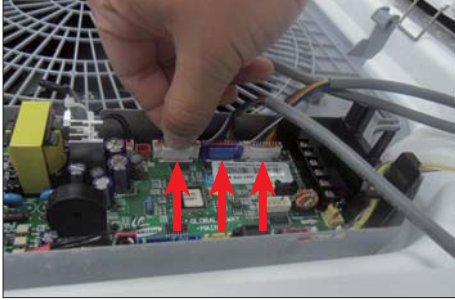

No	Parts	Procedure	Remark
		5) Unscrew bolt and Separate Blower from the motor. (Use +Screw Driver)	
2	EVAPORATOR & DRAIN-PAN	1) Detach EEV and Sensor connectors from the PCB. (Use +Screw Driver) 2) Unscrew 8 screws and Detach Cover-Pipe. (Use +Screw Driver) 3) Unscrew 31 screws and detach Cabinet-Base Blower and Cabinet-Base Drain. (Use +Screw Driver)	   

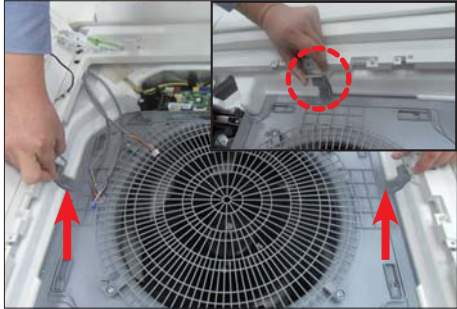
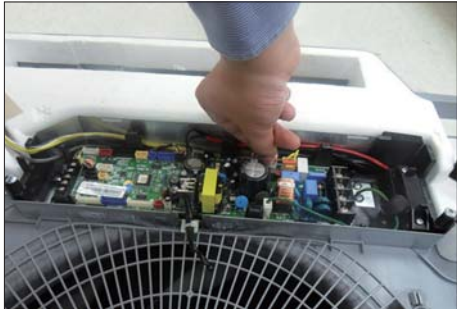
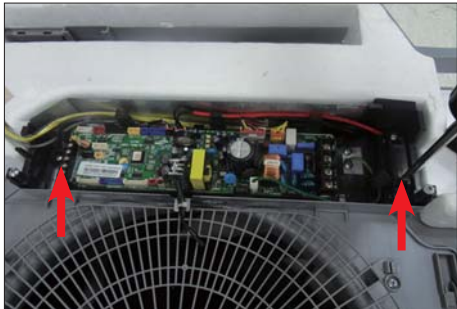
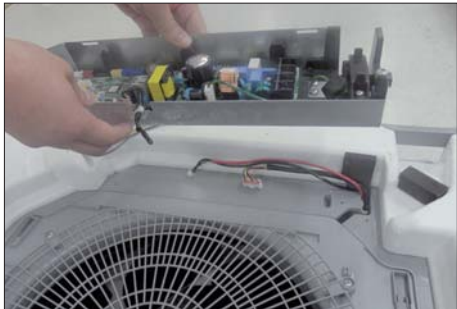

No	Parts	Procedure	Remark
		<p>4) Unscrew 10 screws and detach Drain-Pan from the indoor unit. (Use +Screw Driver)</p> <p>5) Separate Evaporator from the indoor unit.</p>	  

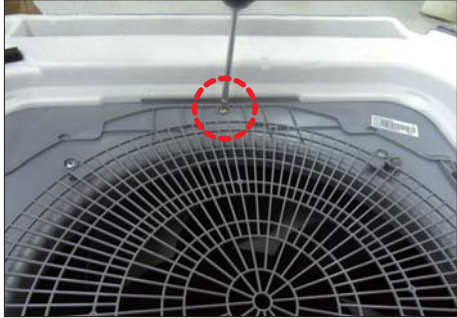

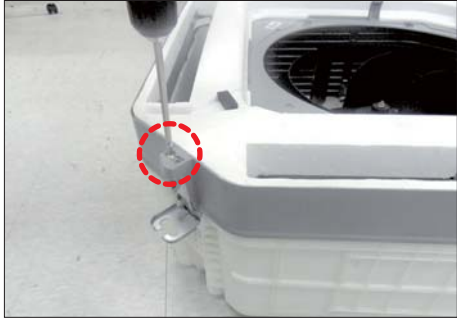

■ Global 4way Cassette type

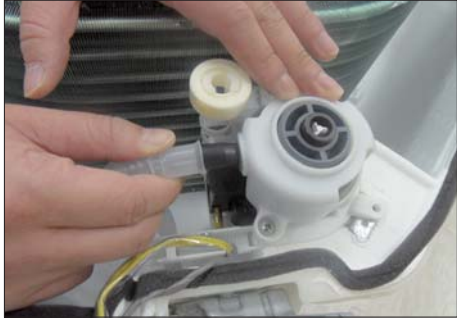
No	Parts	Procedure	Remark
1	Panel	<ol style="list-style-type: none"> 1) Push the handles on both sides of the Samsung logo towards the product's interior to open the Grille. 2) Push up the green knob in the Open direction, and detach the white link from the panel. Detach the safety clip. 3) Remove the 2 fixed screws to remove the Control-Box Cover. (Use +Screw Driver) 4) Remove the Remocon-Receiver and Blade Connector Wire from the PBA. (3EA) 5) Push the 4 panel corners and cover downwards to remove it. 	    

No	Parts	Procedure	Remark
		<p>6) Disassemble the bolts that are assembled with the indoor unit at the 4 panel corners.</p> <p>7) Press the Steel Hangers at both sides of the panel inwards, and rotate them 90 degrees to remove it from the indoor unit's Hock. Remove the panel from the indoor unit.</p>	 
2	Control-Box	<p>1) Disconnect the Connector Wire that is connected to the indoor unit's PBA from the PBA.</p> <p>2) Unscrew the 2 fixed screws on both sides of the Control Box, and disassemble the Control Box from the indoor unit. (Use +Screw Driver)</p>	  

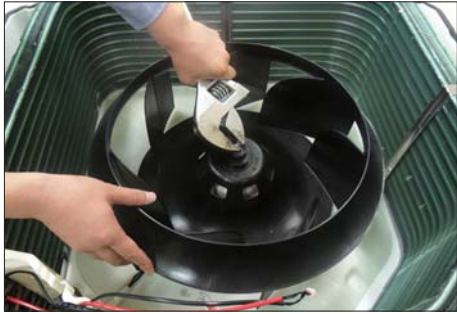
No	Parts	Procedure	Remark
3	Bell-Mouth	<p>1) Unscrew the screw fixed on the Bell-Mouth. (Use +Screw Driver)</p> <p>2) Push the Bell-Mouth in the direction opposite to where it's installed on the Control-Box to remove it.</p>	 
4	Drain Pan	<p>1) Unscrew the screws on the 4 corners of the indoor unit. (Use +Screw Driver)</p> <p>2) Remove the Drain Pan from the indoor unit.</p>	 

No	Parts	Procedure	Remark
5	Drain Pump & Hose	<p>1) Remove the 2 fixed screws and disconnect the white drainage hose from the Drain Pump. (Use +Screw Driver)</p> <p>2) Remove the 2 screws and take the Drain-Hose out from the indoor unit to disassemble the transparent Drain-Hose fixed on the side of the indoor unit. (Use +Screw Driver)</p>	  
6	Evap. Temperature Sensor	<p>1) Use your hand to remove the temperature sensor attached to the Evap Pipe along with the fixing clip.</p>	



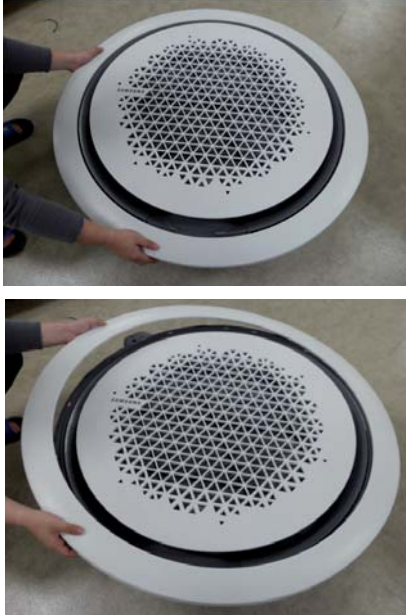

No	Parts	Procedure	Remark
7	Fan & Motor	<p>1) Turn the hexangular nut attached to the top of the Fan counterclockwise to remove it. Take the Fan out of the Motor.</p> <p>2) Turn the three hexangular nuts on the Motor counterclockwise to remove the nuts. Take the Motor Wires attached to these three locations out with your hands prior to removing the Motor.</p>	  
8	Evaporator	<p>1) Remove the screws of the 2 Steel Holder Evaps that are used to fix the Heat Exchanger, and then remove it. (Use +Screw Driver)</p> <p>2) Remove the 2 fixing screws of the Partition Evap at the Heat Exchanger's In/Out Pipe. (Use +Screw Driver)</p>	 

No	Parts	Procedure	Remark
		<p>3) Remove the screw of the Cover Pipe that is used to fix the In/Out Pipe. Remove the In/Out Pipe. (Use +Screw Driver)</p> <p>4) Remove the Heat Exchanger from the indoor unit's cabinet.</p>	  





■ 360 Cassette



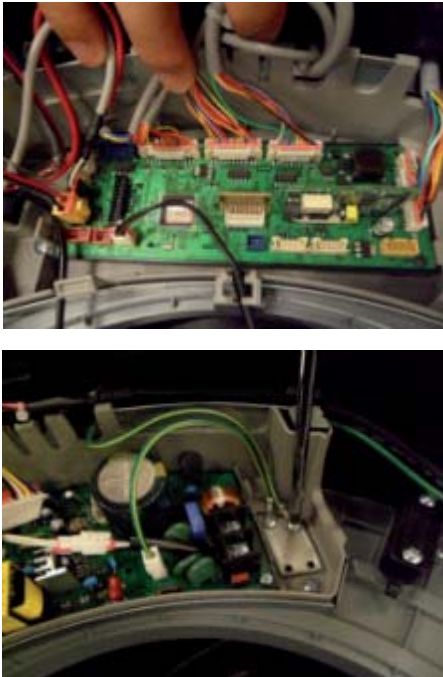
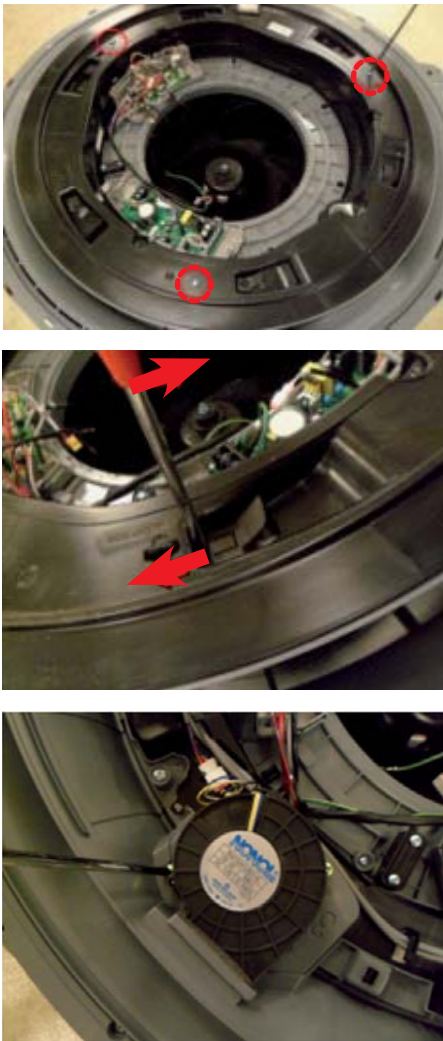

No.	Parts	Procedure	Remark
1	Panel	<p>► Ceiling type Panel</p> <p>1) Pull up the corner 4 places of Panel and separate it.</p> <p>2) Remove the 4 screws from the corner of Panel. (Use +Screw Driver)</p> <p>3) Pull the hook of Panel and then separate the Panel from the Indoor Unit.</p>	
1	Panel	<p>► Open type Panel</p> <p>1) Rotate the outside Panel to counterclockwise direction and then separate it.</p>	

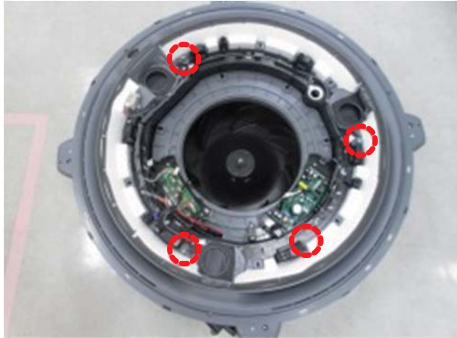
No.	Parts	Procedure	Remark
1	Panel	<p>2) Rotate the Grille to counterclockwise direction.</p> <p>3) Remove the safety clip of Grill inside and then separate the Panel from the Indoor Unit.</p> <p>4) Pull up the Filter from the Grill and separate it.</p>	  
2	Control Box	<p>1) Remove the 2 screws which are fixed to the Indoor Unit upper part. (Use +Screw Driver)</p> <p>2) Rotate the Guard Fan to counterclockwise direction and separate it</p>	 

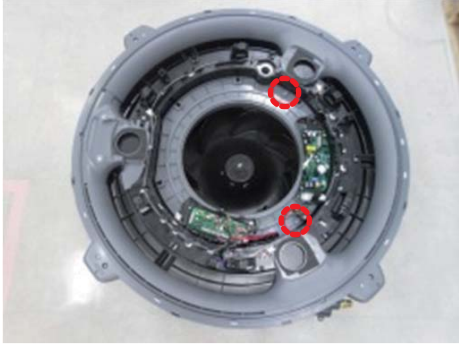

No.	Parts	Procedure	Remark
2	Control Box	<p>3) Reomove the 1 screw which is fixed to the Indoor Unit upper part.(Use +Screw Driver)</p> <p>4) Put finger in the "PULL" marked groove and then pull up the Cover</p> <p>5) Put finger in the "PULL" marked groove and then avoids the hook and it opens the Control Box Cover</p>	    





No.	Parts	Procedure	Remark
2	Control Box	<p>6) Separate the connectors from the Control Box.</p> <p>7) Remove the ground screw. (Use +Screw Driver)</p>	
3	Top Cover & Drain Pan	<p>1) Remove the 3 screws. (Use +Screw Driver)</p> <p>2) Push the hook and separate the Cover. ⚠ Damage can occur to product in case of use a sharp tool.</p> <p>3) Remove the screw which is fixed to Booster Fan. (Use +Screw Driver)</p>	

No.	Parts	Procedure	Remark
3	Top Cover & Drain Pan	<p>4) Pull the Booster Fan connector and separate the connector.</p> <p>5) Remove the 4 screws. (Use +Screw Driver)</p> <p>6) Push the hook and separate the Cover.</p>	    

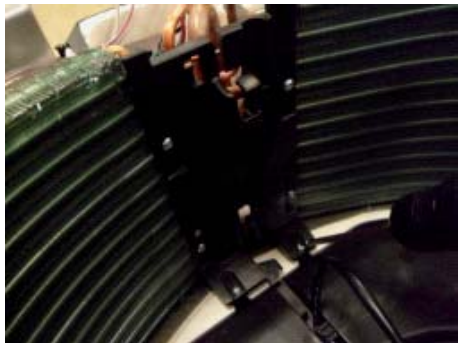
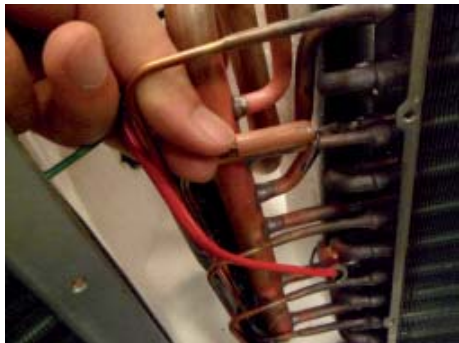
No.	Parts	Procedure	Remark
3	Top Cover & Drain Pan	<p>7) Remove the screw and separate the Display Cover. (Use +Screw Driver)</p> <p>8)) Remove the 2 screws. (Use +Screw Driver)</p> <p>9) Push the hook and separate the Cover.</p> <p>10) Remove the 8 screws. (Use +Screw Driver)</p> <p>11) Separate the Indoor Unit upper part from the Body</p>	    

No.	Parts	Procedure	Remark
3	Top Cover & Drain Pan	<p>12) Remove the 3 screws. (Use +Screw Driver)</p> <p>13) Pull the hook that is on the side and separate the Cover.</p>	   
4	Drain Pump & Hose	<p>1) Separate the Drain Hose from the Drain Pump.</p>	

No.	Parts	Procedure	Remark
4	Drain Pump & Hose	2) Remove the 2 screws and separate the Drain Hose that is on the side lower part of Indoor Unit (Use +Screw Driver)	
5	Fan & Motor	1) Remove the hex nut which is fixed to top of Fan and separate the Fan from the Motor. (Use Monkey Spanner) 2) Remove the 3 hex nuts which is fixed to Motor and separate the Motor from the Indoor Unit. (Use Monkey Spanner)	 
6	Temperature Sensor	1) Remove the 6 screws which is fixed to Evaporator and separate the Partition. 2) Separates the Temperature Sensor which is fixed to Evaporator Pipe with the fixing clip together by the hand.	 

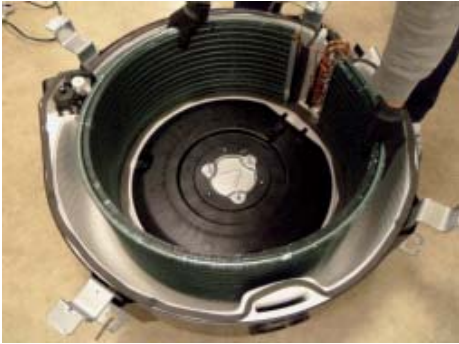
No.	Parts	Procedure	Remark
4	Evaporator	<p>1) Remove the screws which is fixed to Indoor Unit and separate the Evaporator fixing bracket. (Use +Screw Driver)</p> <p>2) Remove screws which is fixed to Indoor Unit and pull the hook and then separate the Drain Cover. (Use +Screw Driver)</p> <p>⚠ When assemble, be careful with the interference structure of piping projecting part.</p> <p>3) Separate the Evaporator from the Indoor Unit.</p> <p>⚠ If you remove the Evaporator with bare hands, it may injure your hands, gloves must be worn.</p>	    

■ Duct type(Slim1,2)

No	Parts	Procedure	Remark
1	Motor & Blower	<p>1) Disassemble the Cabinet-Top Motor. – Unscrew 8 screws</p> <p>2) Disassemble 2 Cover Blower Uppers. – After unscrewing 2 screws</p> <p>– Disassemble the Cover Blower Upper with pushing its hook.</p> <p>3) Disassemble the Cover Control. – Unscrew 2 screws</p> <p>4) Disassemble Motor Wires connected to the inside of PCB and connected to the Capacitor.</p>	 <p>The 'Remark' column contains four sequential photographs illustrating the disassembly process. The first photo shows the top of the cabinet with eight screws circled in red. The second photo shows the interior with two screws on the blower covers circled in red. The third photo shows hands pushing the blower cover outwards. The fourth photo shows a close-up of the PCB with motor wires being disconnected, with the connection points circled in red.</p>

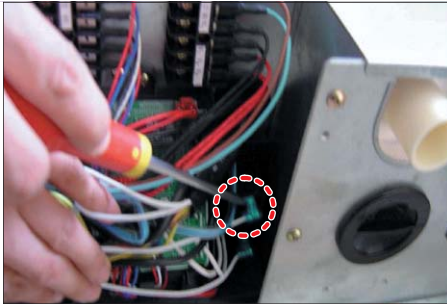
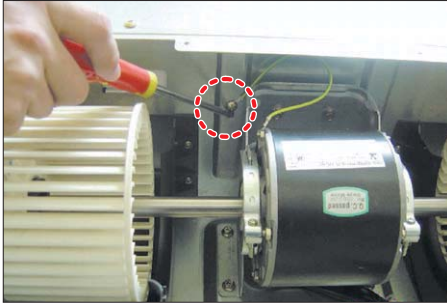
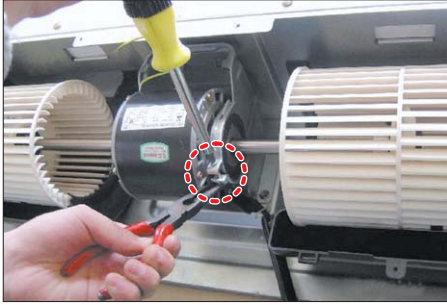
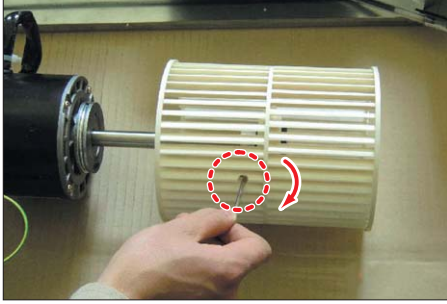
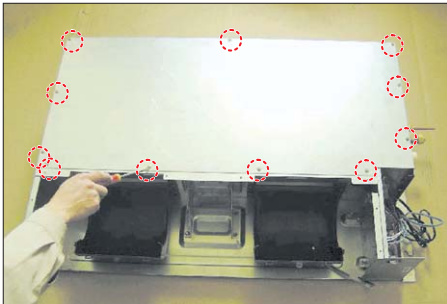
No	Parts	Procedure	Remark
		<p>5) Disassemble the Motor earth wire connected to the Partition. – Unscrew a screw</p> <p>6) Disassemble the band Motor for fixing the Motor. – Unscrew 2 screws</p> <p>7) After disassembling the Motor and Blower for the set, disassemble the Blower by use of 3mm wrench.</p>	   
2	Ass'y Drain Pan	<p>1) Disassemble the Cabinet-Top Evap. – Unscrew 11 screws</p>	

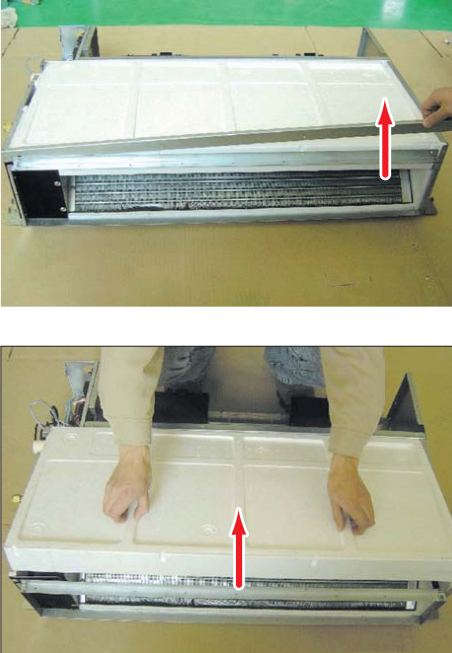
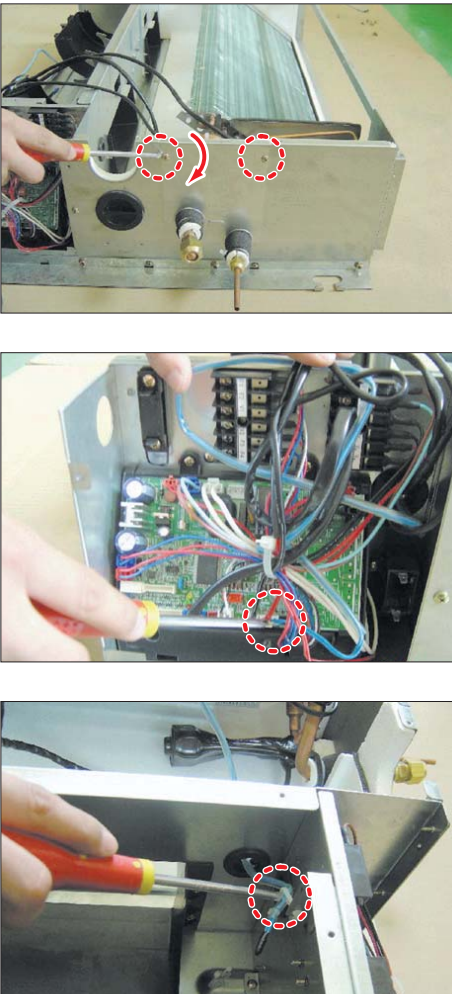
No	Parts	Procedure	Remark
		<p>2) Disassemble the Bracket Outlet Sub that fixes the Drain Pan equipped on the front of the set. – Unscrew 6 screws</p> <p>3) Disassemble the Drain Cushion from the set.</p>	
3	Ass'y Evap	<p>⚠ The Evaporator should be disassembled after disassembling the Cover Control 1-3) and the Drain Pan 2-1), 2-2), 2-3).</p> <p>1) Disassemble the Cover Pipe that fixes the high/low pressure Pipe. – Unscrew 2 screws</p> <p>2) Disassemble the refrigerant temperature sensor, Inlet air temperature sensor, and EEV wire that connected to the inside of PCB.</p>	

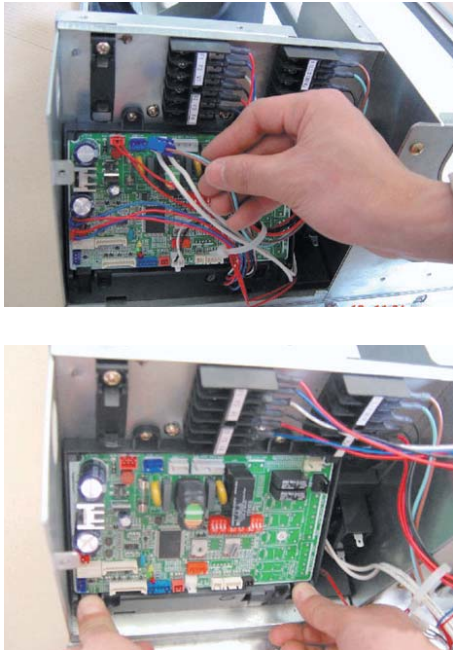
No	Parts	Procedure	Remark
		<p>3) Disassemble the Support Evap. LF that fixes the Evaporator. – Unscrew 2 screws</p> <p>4) Disassemble the Support Evap RH. – Unscrew 2 screws</p> <p>5) Disassemble the Evaporator form the set.</p>	
4	Ass'y Control In	<p>⚠ The Control In should be disassembled after disassembling the Cover Control 1-3).</p> <p>1) Disassemble all Control Wires connected to the inside of PCB.</p> <p>2) In case of disassembling the PCB separately, disassemble the PCB from the case with pushing the hook after unscrewing the screw. – Unscrew 1 screw</p>	

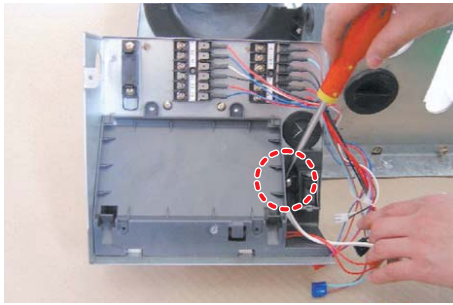
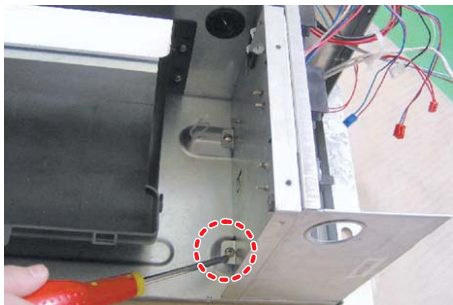
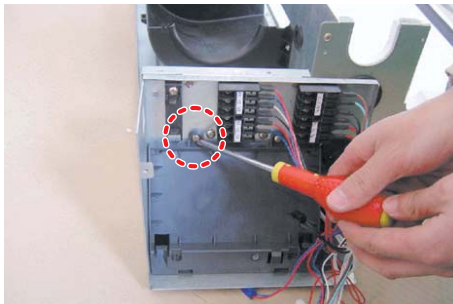
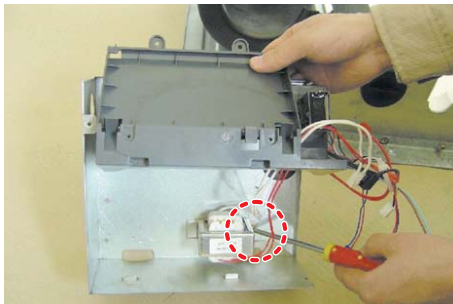
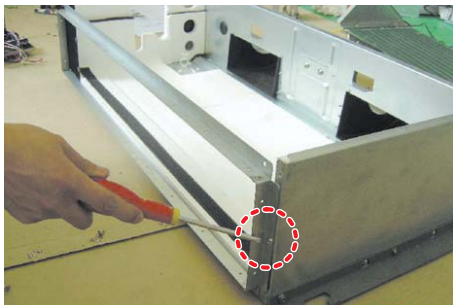

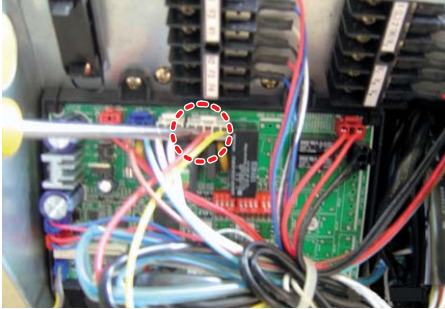
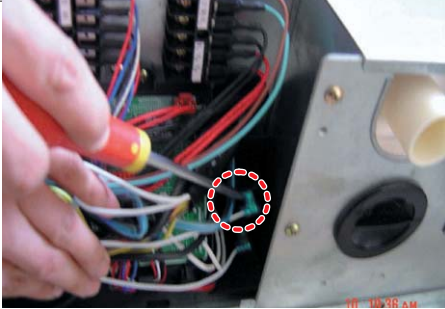
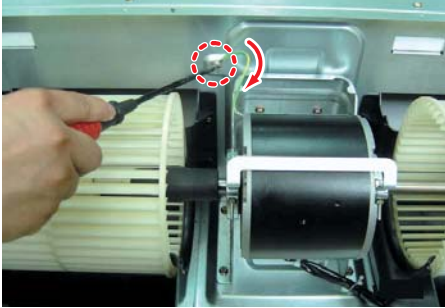
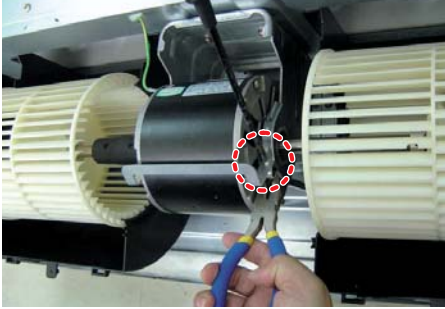

No	Parts	Procedure	Remark
		<p>3) In case of disassembling the Capacitor separately, disassemble the Capacitor from the Case.</p> <p>4) In case of disassembling the Case Control, disassemble the Case Control from the set after unscrewing the screw connected to the direction of Blower.</p> <p>⚠ Disassemble if after disassembling the Cabinet Top Motor 1-1).</p> <p>5) In case of disassembling the Trans Power, unscrew the screw fixing on the Case.</p> <p>⚠ Disassemble if after disassembling the case PCB 4-4).</p>	  
5	Bracket Outlet	<p>1) Disassemble the Bracket Outlet assembled on the Cabinet.</p> <p>– Unscrew 10 screws</p>	 

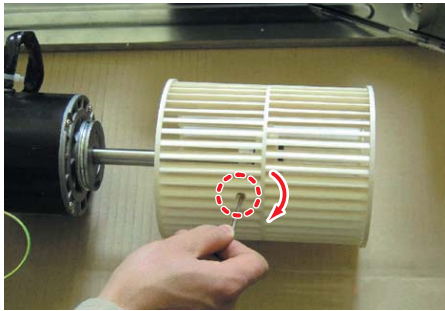
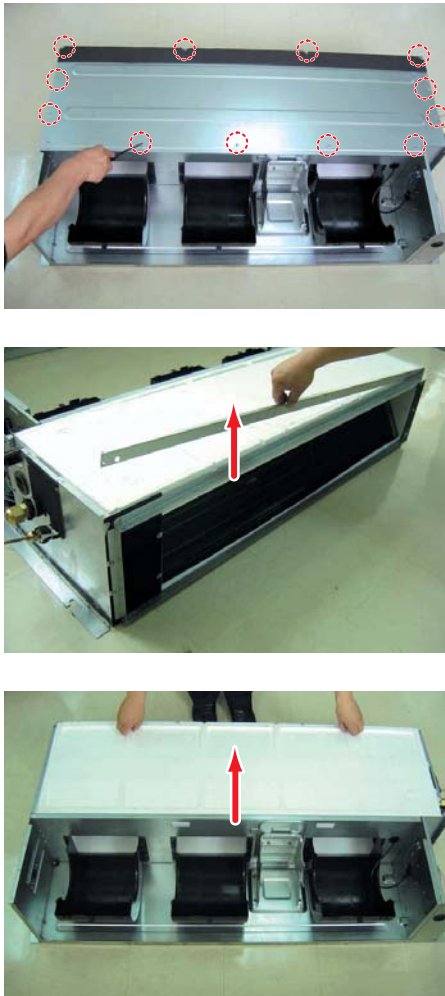

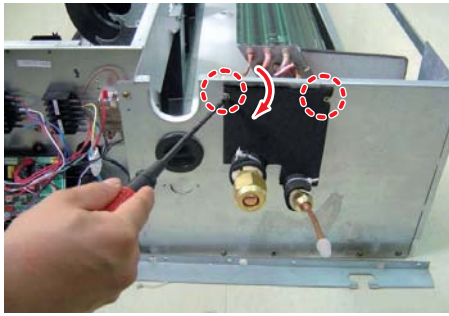
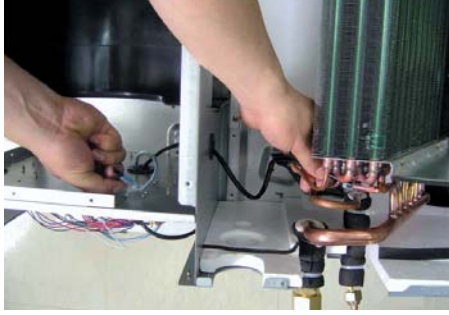
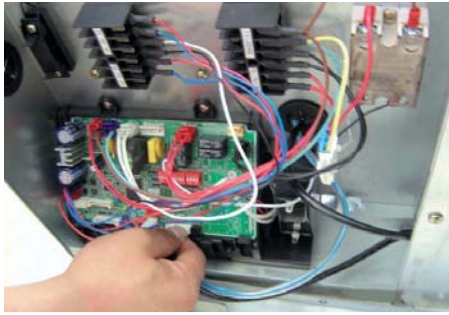
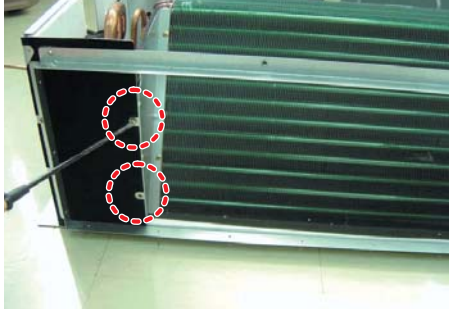
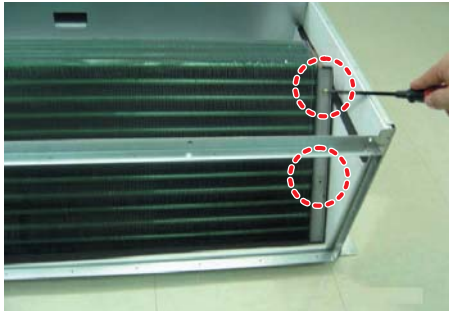
No	Parts	Procedure	Remark
		<p>3) If the Cabinet-Top Motor is assembled on the side of the set, the procedure of disassembling the Filter is just as the above.</p>	
5	Bracket Outlet	<p>1) After disassembling 13 indicating screws, detach Ass'y Cabinet-Top Motor.</p> <p>2) After disassembling 3 indicating screws, detach Ass'y Case Blower Upper.</p> <p>– Press the pothook of the Case Blower and detach Ass'y Case Blower Upper.</p>	

No	Parts	Procedure	Remark
		<p>3) After disassembling 2 indicating screws, detach the Cover Control.</p> <p>4) Detach the Motor Wire Connected to PCB and Capacitor.</p> <p>5) After disassembling the indicating screws, detach the wire connected to the Partition.</p> <p>6) After disassembling 2 indicating screws, detach the Ass'y Band Motor.</p>	    



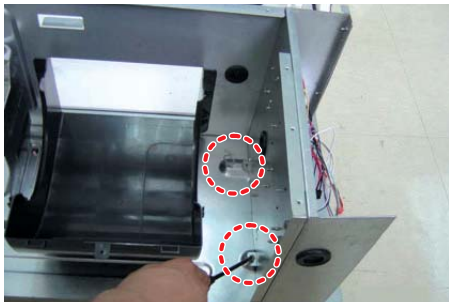

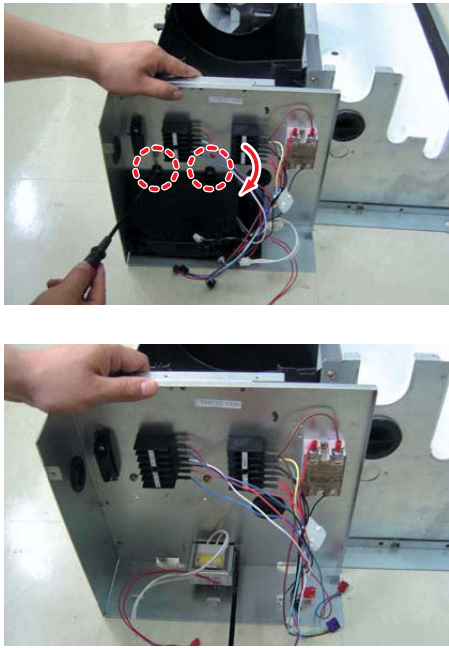
No	Parts	Procedure	Remark
		<p>7) After disassembling the Motor and Blowers, detach the Blowers from the axis of the Motor by 3mm inner hexagon spanner.</p>	
3	Drain Pan	<p>1) After disassembling 15 indicating screws, detach Ass'y Cabinet-Top Evap.</p> <p>2) After disassembling 6 indicating screws, detach the Bracket Outlet.</p> <p>3) Detach the Drain Pan.</p>	

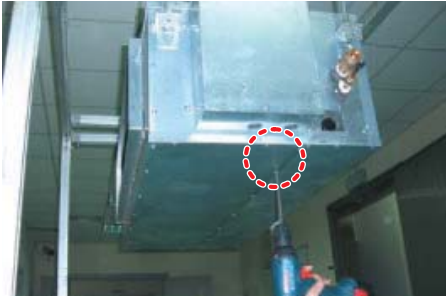

No	Parts	Procedure	Remark
4	Evaporator	<p>⚠ After finished the procedures above, detach the Evaporator.</p> <p>1) After disassembling 2 indicating screws, detach Ass'y Cover Pipe.</p> <p>2) Detach the Sensor from the Control Box. (including 2 Sensors)</p> <p>3) After disassembling 2 indicating screws, detach Ass'y Support Evap LF.</p> <p>4) After disassembling 2 indicating screws, detach Ass'y Support Evap RH.</p>	    

No	Parts	Procedure	Remark
		5) Detach the Evaporator from the set.	
5	Control In	<p>⚠ Detach the parts of Control In after disassembling the Cover Control.</p> <p>1) Detach all the wires connected to the PCB.</p> <p>2) If only the disassembly of PCB required, press the Pothook and detach the PCB from the set.</p> <p>3) If only the disassembly of Capacitor is required, detach it from the set.</p> <p>4) If only the disassembly of Case Control is required, detach it from the set after disassembling 2 indicating screws.</p>	   





No	Parts	Procedure	Remark
7	Ass'y Cross Fan	5) Detach the Transformer after disassembling 2 indicating screws. ⚠ Work is possible after disassembling the Case PCB.	
6	Ass'y Bracket Outlet	2) After disassembling 16 indicating screws, detach Ass'y Bracket Outlet.	

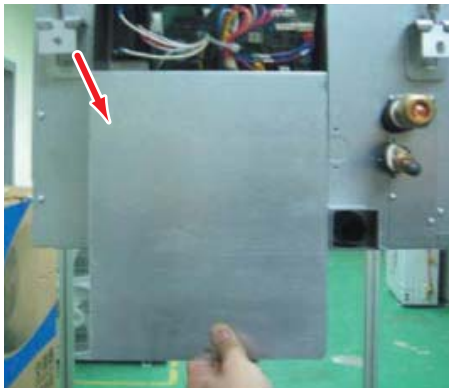
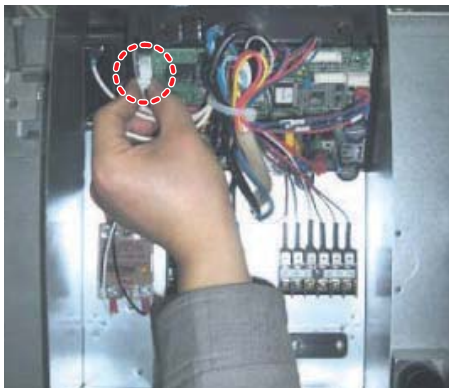

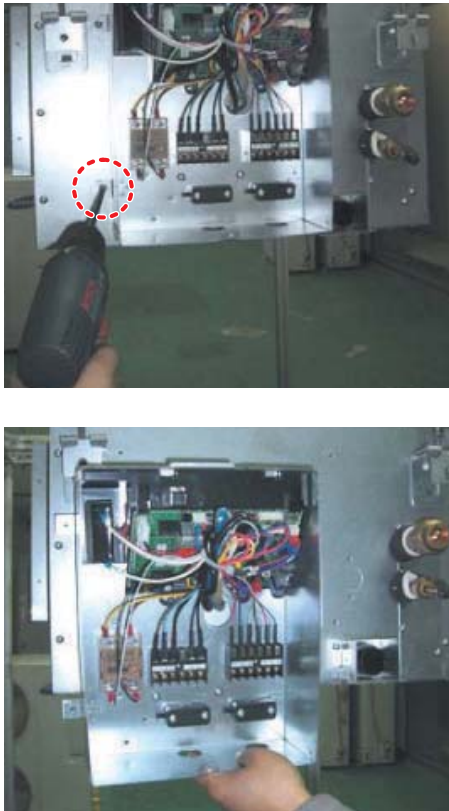
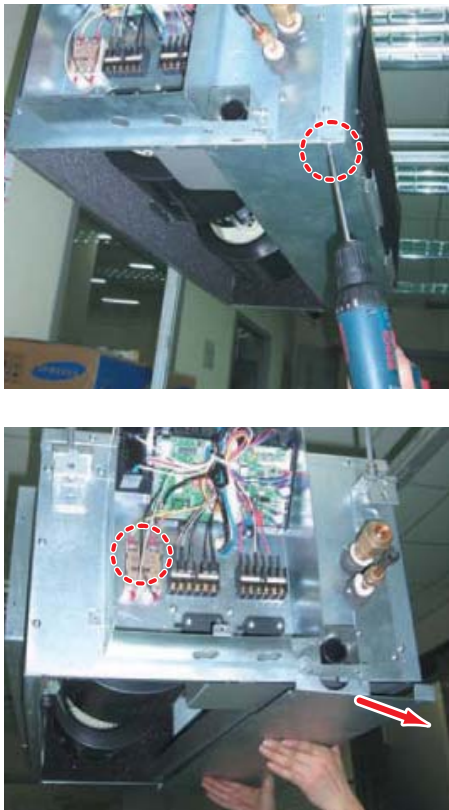

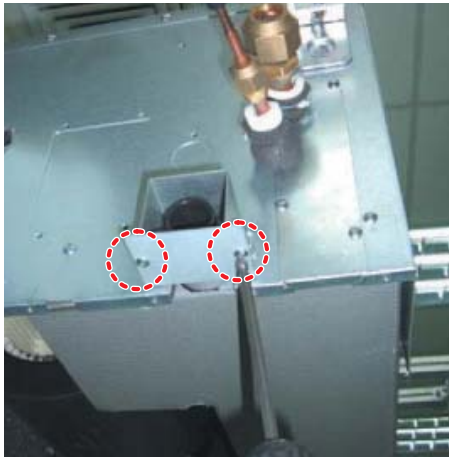
■ Duct type(Mid pressure1)

No	Parts	Procedure	Remark
1	Filter	<p>1) After disassembling 16 places indicating screws, detach Ass'y Cabi Bottom Blower. (Use +Screw Driver.)</p> <p>2) Detach from Ass'y Control In the capacitor connection wire between the Motor Fan and housing connector.</p> <p>3) After disassembling 2 places indicating screws, detach the 2 Fan Case. (Use +Screw Driver.)</p>	   

No	Parts	Procedure	Remark
		<p>4) After disassembling 2 places indicating screws, detach Fan Motor and Blower from the set.</p>	
2	Control In	<p>1) After disassembling 1 Indicating screw, detach the Cover control. (Use +Screw Driver.)</p> <p>2) Detach the Motor-Fan and Sensor Connector from the PCB.</p>	  

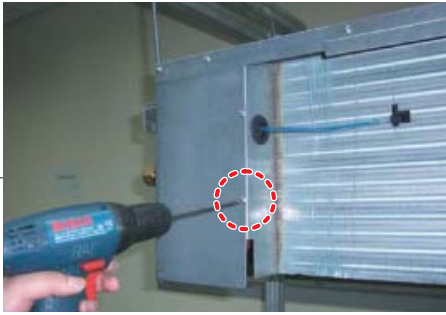

No	Parts	Procedure	Remark
		<p>3) Disassemble 4 indicating screws and detach Control In from the set. (Use +Screw Driver.)</p>	
3	Drain Pan	<p>※ Work is possible when Disassembling the Ass'y Cabi Bottom Blower.</p> <p>1) Disassemble 7 indicating screws and detach Ass'y Cabi Bottom Drain. (Use +Screw Driver.)</p>	

No	Parts	Procedure	Remark
		<p>2) Disassemble 2 indicating screws and detach Holder Pipe. (Use +Screw Driver.)</p> <p>3) Disassemble 4 indicating screws and detach the Drain Pan. (2 screws each at left and right side) (Use +Screw Driver.)</p>	   

No	Parts	Procedure	Remark
4	Evap	<p>Work is possible when Disassembling the Ass'y Drain Pan.</p> <p>1) Disassemble 5 indicating screws to detach Cover Pipe.(Use +Screw Driver.)</p> <p>2) Disassemble Sensor on the Evap.</p> <p>3) Disassemble 4 indicating screws which are in the near of Hanger Plate to detach the Evap. (2 screws each at left and right side) (Use +Screw Driver.)</p> <p>⚠ It needs 2 peoples.</p>	    

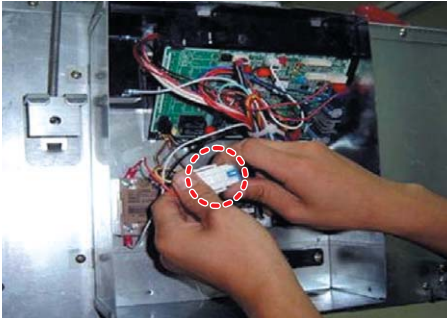

■ Duct type (Mid Pressure2, High Pressure)

No	Parts	Procedure	Remark
1	Blower & Motor	<p>1) After disassembling 15 places indicating screws, detach Ass'y Cabi Bottom Blower. (Use +Screw Driver.)</p> <p>2) Detach from Ass'y Control In the capacitor connection wire between the Motor Fan and housing connector.</p> <p>3) After disassembling 4 places indicating screws, detach the 2 Fan Case. (Use +Screw Driver.)</p>	   

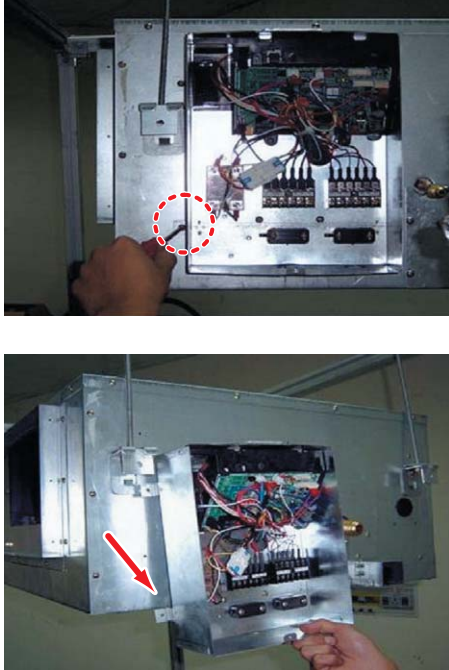
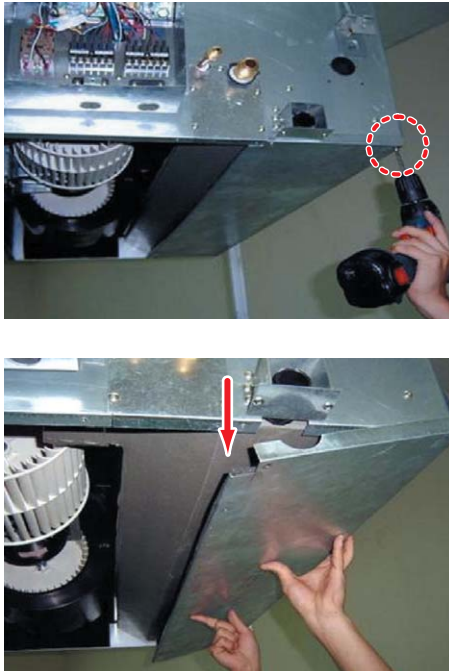

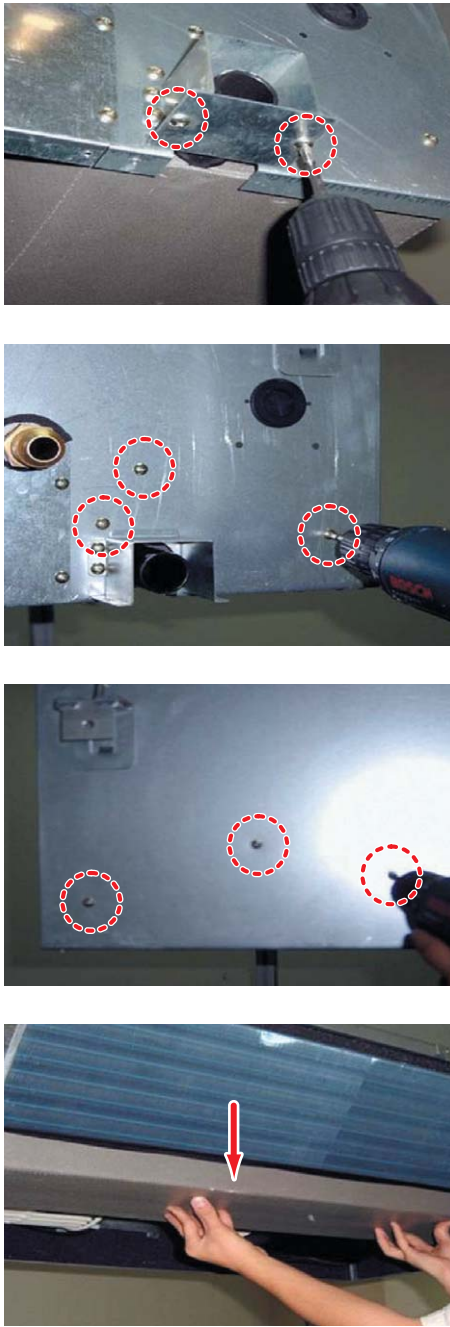
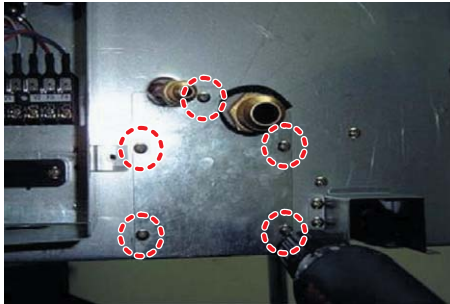
No	Parts	Procedure	Remark
		<p>4) After disassembling 2 places indicating screws, detach Fan Motor and Blower from the set. (Use +Screw Driver.)</p>	
<p>3</p>	<p>Drain Pan</p>	<p>1) After disassembling 1 Indicating screw, detach the Cover control.(Use +Screw Driver.)</p> <p>2) Detach the Motor-Fan and Sensor Connector from the PCB.</p>	  

No	Parts	Procedure	Remark
		<p>3) Disassemble 4 indicating screws and detach Control In from the set. (Use +Screw Driver.)</p>	
3	Drain Pan	<p>※ Work is possible when Disassembling the Ass'y Cabi Bottom Blower.</p> <p>1) Disassemble 6 indicating screws and detach Ass'y Cabi Bottom Drain. (Use +Screw Driver.)</p>	



No	Parts	Procedure	Remark
		<p>2) Disassemble 2 indicating screws and detach Holder Pipe. (Use +Screw Driver.)</p> <p>3) Disassemble 6 indicating screws and detach the Drain Pan. (Use +Screw Driver.) (3 screws each at left and right side)</p>	
4	Evap	<p>※ Work is possible when Disassembling the Ass'y Cabi Bottom Blower.</p> <p>1) Disassemble 6 indicating screws and detach Ass'y Cabi Bottom Drain. (Use +Screw Driver.)</p>	



No	Parts	Procedure	Remark
		<p>2) Disassemble Sensor on the Evap.</p> <p>3) Disassemble 2 indicating screws which are in the near of Hanger Plate to detach the Evap. (1 screw each at left and right side)</p> <p>⚠ It needs 2 peoples.</p>	  



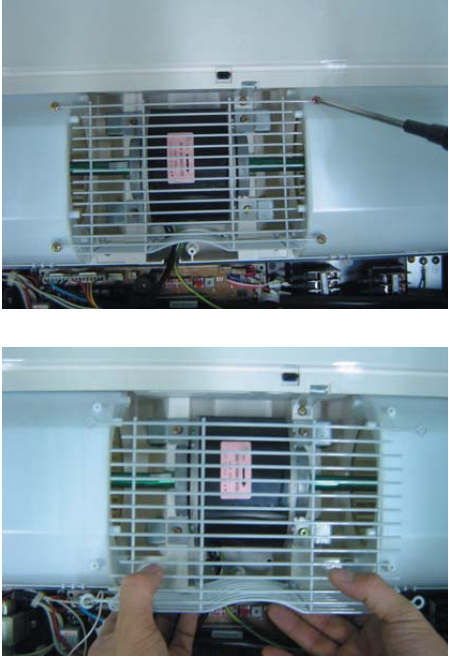

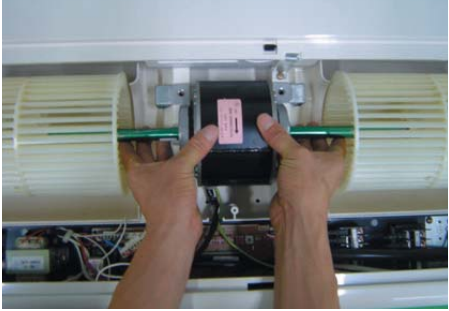
■ CEILING

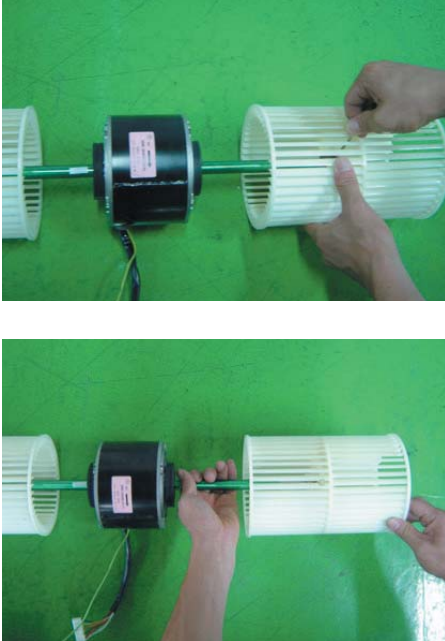

No	Parts	Procedure	Remark
1	Electrical Part	<p>1) Open the Grille by pressing 3 position. (center and both side)</p> <p>2) Detach the Air Inlet Grille.</p> <p>3) Open the Cover of Component Electrical Box by removing 3 screws. (center and both side)</p>	   



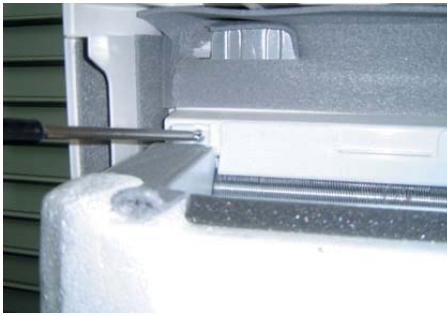

No	Parts	Procedure	Remark
			 
2	Fan & Motor	<p>1) Detach the screw and untie earth wire of Motor.</p> <p>2) Disconnect of housing of Motor Wire.</p> <p>3) Disconnect the Capacitor Wire.</p>	  

No	Parts	Procedure	Remark
		<p>4) Loosen the Guard Safety by removing 6 screws.</p>	
		<p>5) Detach the Upper Case of Fan. (2EA)</p>	
		<p>6) Loosen the 4 screws what is fix the Motor.</p>	
		<p>7) Detach the Fan and Motor assembly.</p>	

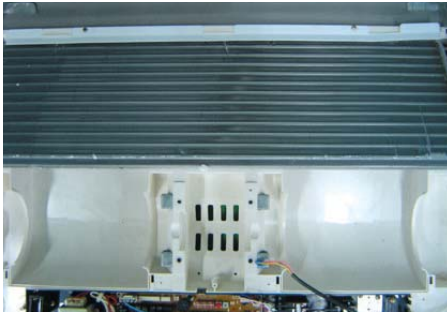

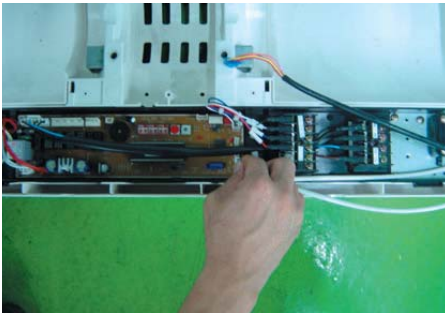
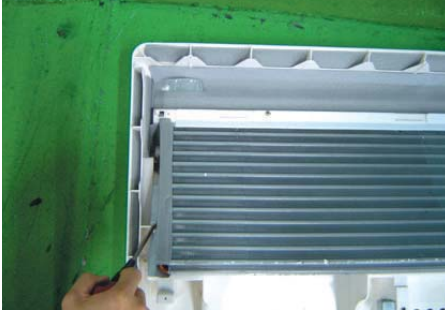

No	Parts	Procedure	Remark
		<p>8) Loosen the set fixing bolts. (with a M3 wrench)</p> <p>9) Detach the Fan.</p>	 <p>The first photograph shows a person's hands using a green M3 wrench to loosen a bolt on a black motor assembly. The second photograph shows the person pulling the white fan housing away from the motor.</p>
3	Drain Pan	<p>1) Disconnect the Display PCB Wire as shown in picture. (white housing)</p> <p>2) Disconnect the Step Motor Wire as shown in picture. (blue housing)</p> <p>3) Disassemble the Hanger Bracket by removing the 1 screw.</p>	 <p>The first photograph shows a hand disconnecting a white wire from a display PCB. The second photograph shows a hand disconnecting a blue wire from a step motor. The third photograph shows the interior of a white drain pan with a hanger bracket being removed.</p>

No	Parts	Procedure	Remark
		<p>4) Loosen the 3 screws of Front Side.</p> <p>5) Disassemble the assembly Front Cover Part.</p> <p>6) Disconnect the Step Motor Wire as shown in picture.</p> <p>7) Detach the Wire Clamp fixed in Base Part.</p> <p>8) Detach the Front Cover assembly completely.</p>	    

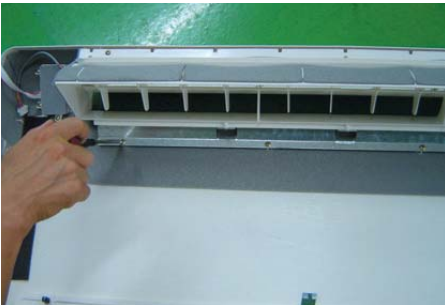

No	Parts	Procedure	Remark
		<p>9) Loosen the screw what is fix with Base Part and Drain Pan. (Upper Side:2EA)</p> <p>10) Loosen the screw what is fix with Base Part and Drain Pan. (Lower Side:2EA)</p> <p>11) Detach the Drain Pan completely.</p>	  

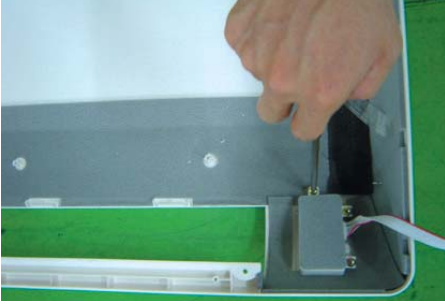

No	Parts	Procedure	Remark
		<p>1) Disconnect the Thermistor Wire as shown in picture. (white housing)</p> <p>2) Loosen the 2 screws shown in picture.</p> <p>3) Loosen the 2 screws shown in picture and remove Plastic Part. (white)</p> <p>4) Loosen the 2 screws shown in picture and remove Steel Bracket.</p> <p>5) Disassemble the 4 screws Steel Plate in rear side of the unit.</p>	    

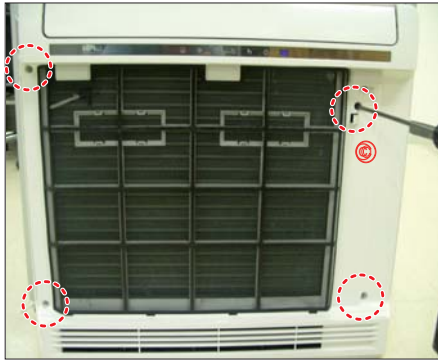

No	Parts	Procedure	Remark
		<p>6 Loosen the 2 screws as shown in picture.</p> <p>7) Detach the Plastic Cover as shown in picture.</p> <p>8) Detach the Evaporator assembly.</p>	  

No	Parts	Procedure	Remark
5	Stepping Motor	<ol style="list-style-type: none"> 1) Loosen the 4 screws in rear side of Front Cover assembly as shown in picture. 2) Loosen the 2 screws as shown in picture. 3) Disassemble the Blade and Stepping Motor assembly and remove the 2 Screws Stepping Motor. 	  
6	Display PCB	<ol style="list-style-type: none"> 1) Loosen the 3 screws in rear side of Front Cover assembly as shown in picture. 2) Disassemble Display PCB assembly and Disconnect Wire. 3) Disassemble the Display PCB. 	 

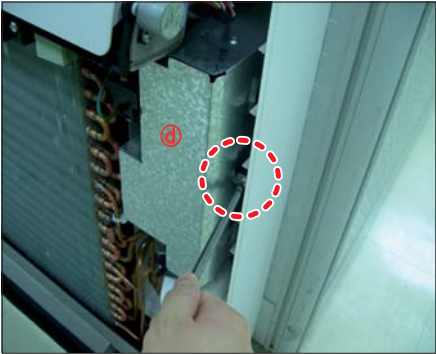

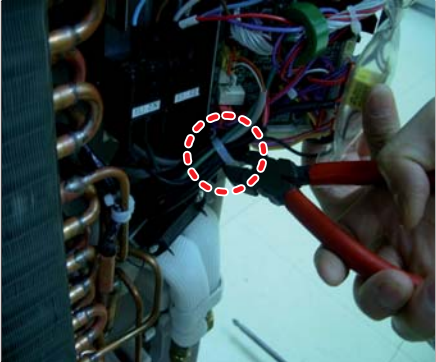
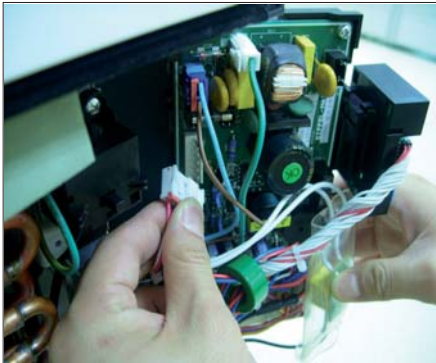

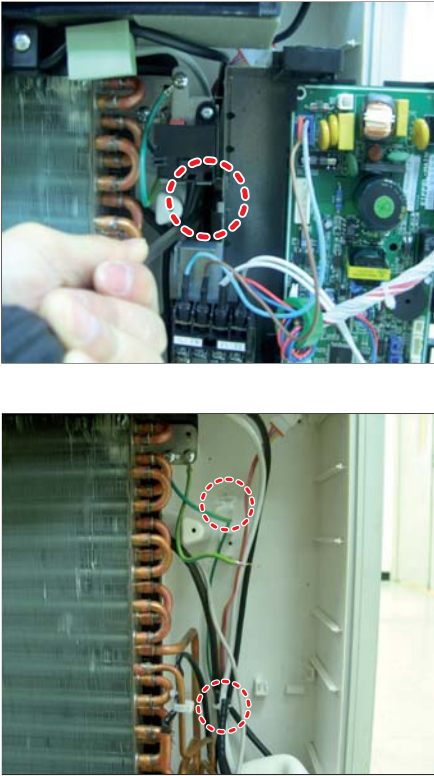
■ CONSOLE

No	Parts	Procedure	Remark
1	Cabi Parts	<p>1) Open the Panel Front(a). Remove the Clip Wire(b).</p> <p>2) Release 4 screws on the Body Front(c).</p> <p>3) Open the Body Front(c) by pulling from bottom of the part.</p>	  

No	Parts	Procedure	Remark
2	Electrical Parts	<p>1) Open the cover of Control Box (④).</p> <p>2) Pull the PBA out along the slide guide.</p> <p>3) Cut the Cable tie.</p> <p>4) Pull all wires out from the PBA.</p>	   

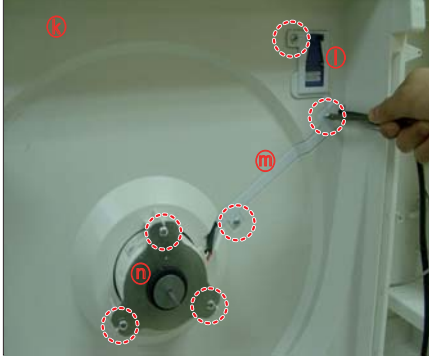

No	Parts	Procedure	Remark
		<p>5) Release the 2 screws. (one is top of the C-Box, the other is left of it)</p> <p>6) Release 2 Hold Wires and pull all wires out from it .</p>	
3	Blowing & Evap Part	<p>1) Pull the Bracket Pipe (Ⓢ) out.</p> <p>2) Release 2 screws and pull Top Discharge Kit (Ⓣ) out.</p>	



No	Parts	Procedure	Remark
		<p>3) Release 2 screws and pull Bottom Discharge Kit(9) out.</p> <p>4) Disconnect the Step Motor wire(h) from the conect wire . This part is right side of the Bottom Discharge Kit(9).</p> <p>5) Pull Bottom Discharge Kit(9) Out from the bottom of it.</p> <p>6) Release 3 screws and pull the Evap out from top to bottom direction.</p>	   



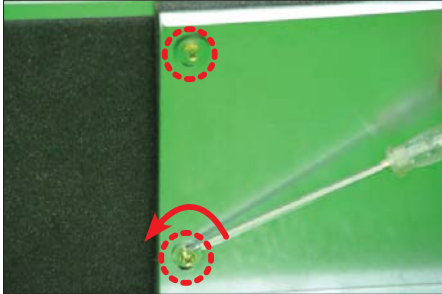
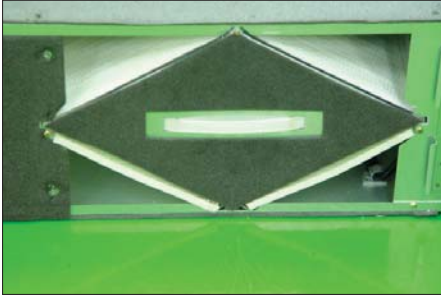
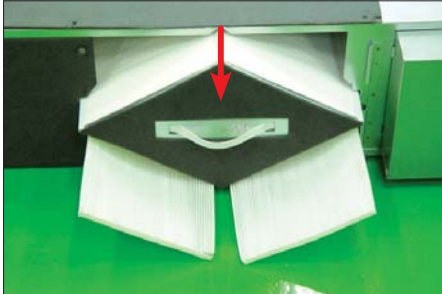

No	Parts	Procedure	Remark
4	Fan Part	<p>1) Release 1 screw and pull the Bell Mouth (①) out.</p> <p>2) Release the Nut and pull Fan Turbo(①) out.</p> <p>3) Release 6 screw on the Body Back(㉔). Pull the Cap MPI(①), Bracket Wire(㉓) and Bracket Motor(㉒) out.</p> <p>4) Pull the MPI Kit(㉑) and Motor</p>	   

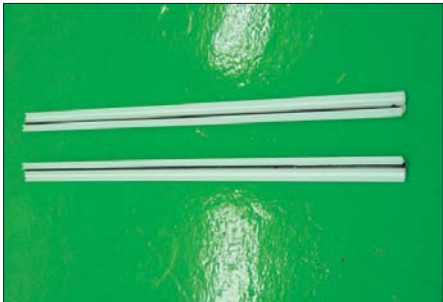

■ ERV PLUS

– All the procedure has to be verified because the cover should not open when the unit is installed.

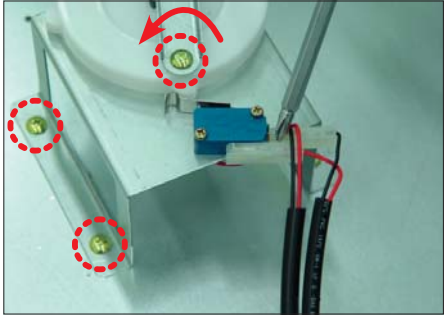
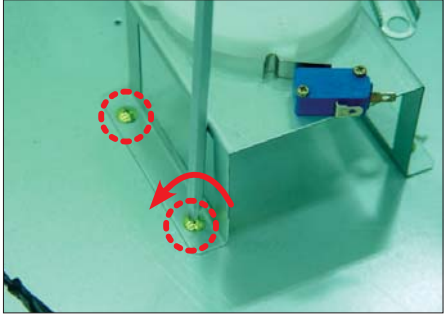
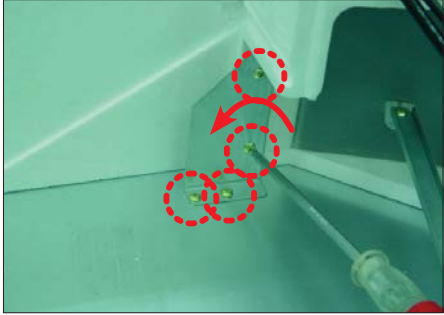
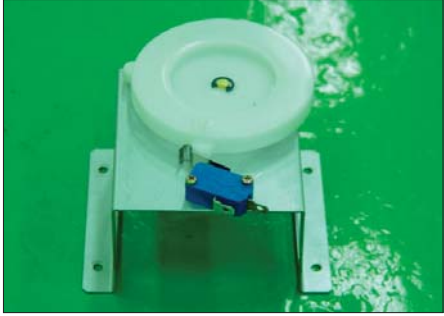

No	Parts	Procedure	Remark
1	ERV (Energy Recovery Ventilator)	1) Stop the air conditioner operation and shut off the main power. 2) Remove the unit from ceiling suspension. (Disassembly is not required when Fan, Motor, Element, Filter replacement or cleaning.)	
2	Cover Element	1) Remove the 2 bolts of the Cover Element. (Use +Screw Driver.) 2) Find the Element and 2 Dust Filters.	 
3	Ass'y Element Ass'y Filter	1) Detach Element and Filter from the unit. Make sure detach the Filter before the Element. 2) There are 2 Element within the product.	 

No	Parts	Procedure	Remark
4	Guide Element	<p>1) Separate the guides fixing Element. (Use +Screw Driver.) 1 Guide is located at each left and right end of the product. Each guide is attached to the product with 1 bolt.</p>	 
5	Ass'y Fan Parts	<p>1) Separate motor connectors.</p> <p>2) Loosen the holder fixing the motor wire by twisting it slightly.</p> <p>3) 2 Motors are placed within the product for supply air and exhaust air.</p>	 



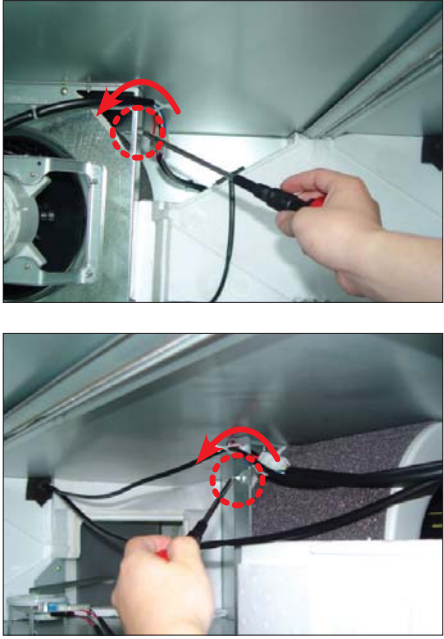
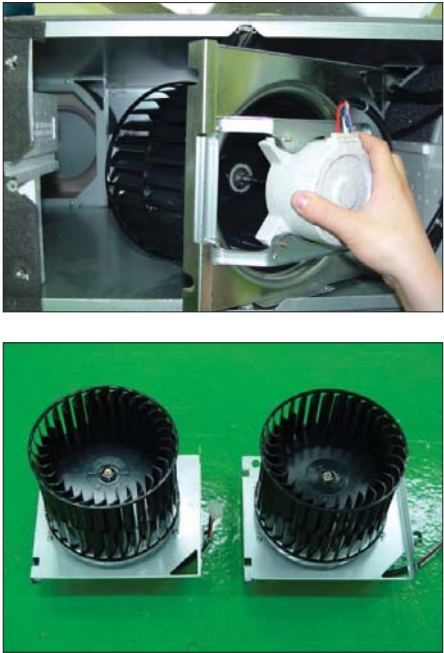

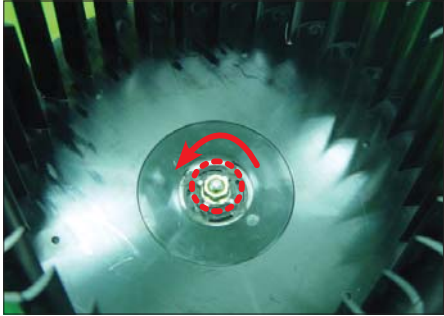
No	Parts	Procedure	Remark
6	Cushion Mid	<p>1) As seen in the picture besides, pull out the EPS structure located at the center of exhaust air and supply air.</p> <p>2) Pull out the EPS structure through the inspection hole.</p> <p>3) Assemble the product by adjusting it with the direction, following the direction carved on the surface of Cushion Mid. Put the part written with "Down↓" downwards and put the part with "Motor→" towards the Motor when assembling the unit.</p> <p>⚠ Make sure not to break down EPS structure.</p>	    

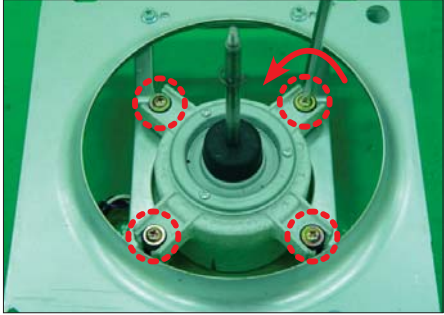

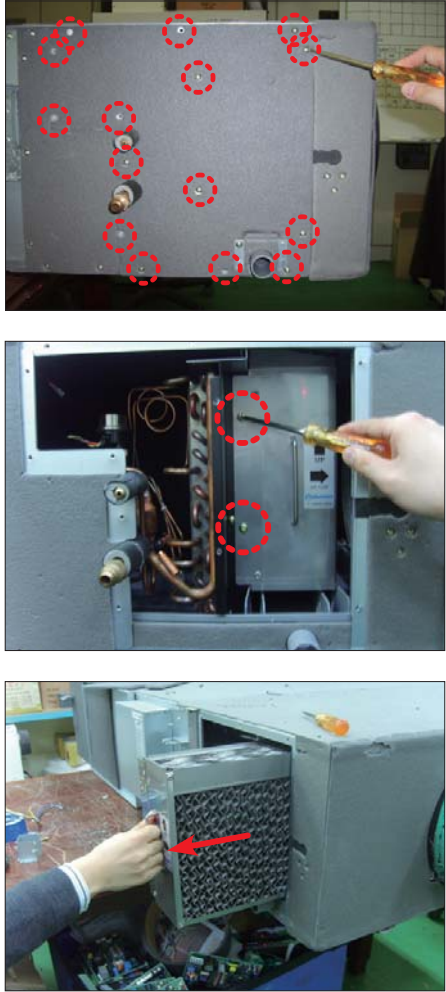
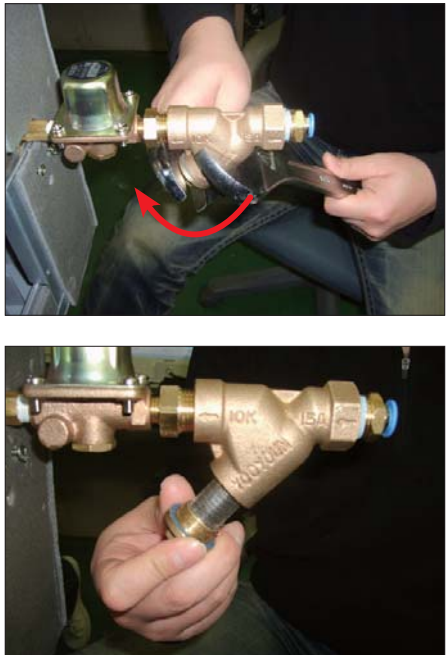
No	Parts	Procedure	Remark
7	Connector Damper Cam	<ol style="list-style-type: none"> 1) Separate the Damper from the unit. (Use +Screw Driver.) 2) Separate the connectors by holding their bodies and pulling them out. 3) Unscrew bolts attached to Bracket and Cam. (Use +Screw Driver.) 	    

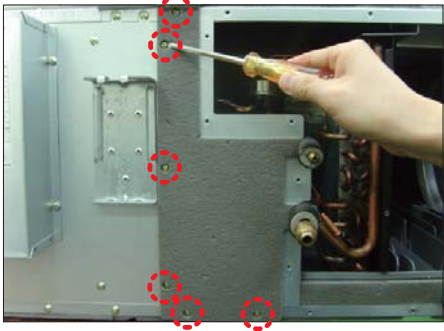
No	Parts	Procedure	Remark
8	Ass'y Fan Parts	<p>⚠ Ensure to separate the Damper before the Fan.</p> <p>1) Rotate bolts fixing the Bracket 10 turns. Input and outlet of the products have 2 bolts each. (Use +Screw Driver.)</p> <p>⚠ The bolts are not required to be removed.</p>	
9	Ass'y Bracket Motor	<p>1) Detach the whole Ass'y Blower Motor (which is made up of Fan, Motor, Bracket Motor, and Cover Bell Mouse) through the inspection hole.</p> <p>2) 2 Motors are placed within the unit for supply air and exhaust air.</p>	

No	Parts	Procedure	Remark
10	Blower Motor-Fan	<p>1) Unscrew the nuts fixing the Fan by rotating them left. (Use Monkey Spanner.)</p> <p>2) Unscrew the bolts fixing motor to detach it from the Motor Bracket. It has 4 bolts. (Use +Screw Driver.)</p> <p>⚠ Do not touch the Fan. Its sharp edge may cause injury.</p>	  

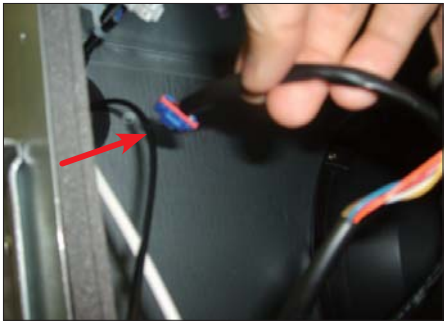
No	Parts	Procedure	Remark
11	Element Etc Humidifier	<p>1) Unscrew 15 screws from the Cover Humid to separate them from the product.</p> <p>2) Unscrew 2 screws from the Element Humidifier.</p> <p>3) Hold the handle of the Element Humidifier and pull to the direction indicated by the arrow to separate it from the product.</p>	
12	Ass'y Flow Valve	<p>1) Use 2 monkey spanners to hold the Ass'y Flow Valve as shown in the image, and rotate the monkey spanner on the right hand to the direction indicated by the arrow to unscrew the plug.</p> <p>2) Completely separate the plug by hand and remove foreign substances.</p>	

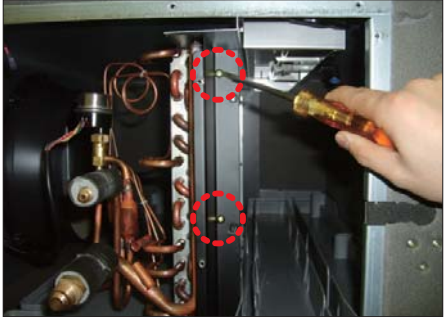
No	Parts	Procedure	Remark
13	Ass'y Evap Parts	<ol style="list-style-type: none"> <li data-bbox="485 293 900 353">1) Unscrew 6 screws from the Cover Evap to separate them from the product. <li data-bbox="485 645 884 705">2) Unscrew 4 screws from the Case PCB to separate them from the product. <li data-bbox="485 996 900 1070">3) Separate the PCB connection housing of the Valve Expan and move the housing as shown in the picture. 	    

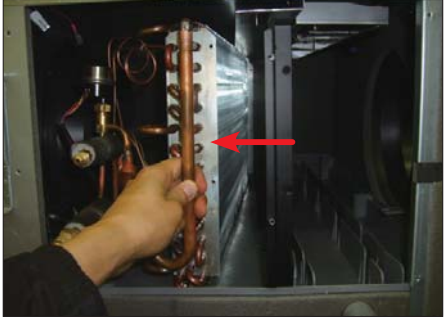
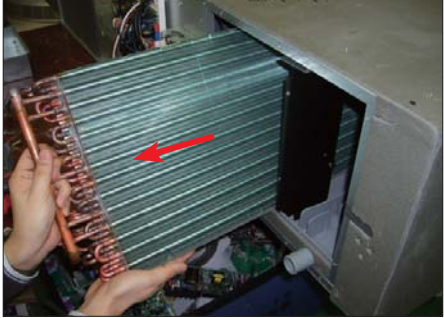
No	Parts	Procedure	Remark
		<p>4) Separate the 2 thermal sensors attached to Ass'y Evap.</p> <p>5) Unscrew 2 screws from the Support Evap L.</p> <p>6) Unscrew 2 screws from the Support Evap R.</p> <p>7) Pull the Ass'y Evap to the direction indicated by the arrow to separate it from the fixed part.</p> <p>8) Hold the end part of the Ass'y Evap and pull to the direction indicated by the arrow to separate it from the product.</p>	    

■ Floor Standin Type

– All the procedure has to be verified because the cover should not open when the unit is installed.

No	Parts	Procedure	Remark
1	Cabinnet	<p>1) Unscrew fixed screw of the upper part cabinet, and please separate</p> <p>2) Please separate front cabinet.</p>	

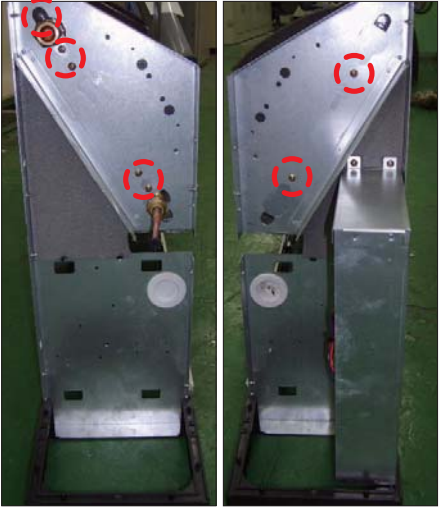
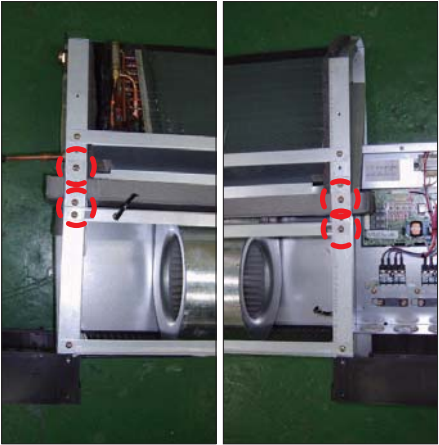
No	Parts	Procedure	Remark
2	Heat Exchanger	<p>1) Unscrew two fixed screws, and please separate heat exchanger cover.</p> <p>2) Unscrew fixed screw on both side of heat exchanger plate. And then pulls heat exchanger to the right side, and please separate.</p>	  
3	Drain Pan	<p>1) Please remove PLATE for fixation of DRAIN PAN located in the side.</p>	

No	Parts	Procedure	Remark
4	Motor & Fan	<ol style="list-style-type: none"> 1) Process hopes for DRAIN PAN isolation work in this work earlier. 2) Unscrew MOTOR BRACKET fixation screw located in the front surface, and please separate. 3) Unscrew MOTOR BRACKET fixation screw located in the side, and please separate. 4) Separate out MOTOR BRACKET for front side. 	  

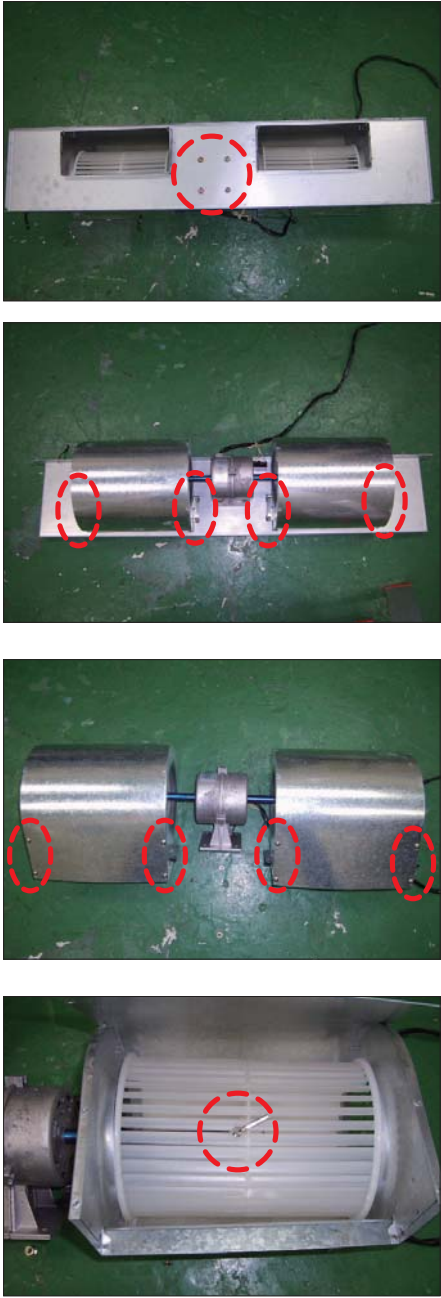
No	Parts	Procedure	Remark
4	Motor & Fan	<p>5) Unscrew fixed screw of MOTOR BRACKET and FAN CASING, and please separate.</p> <p>6) Unscrew fixed screw of FAN CASING, and please separate.</p> <p>7) Unscrew FAN and the fixed screw of the MOTOR axis, and please separate. (use Wrench)</p>	

Wall Mounted type(Neo Forte without EEV)



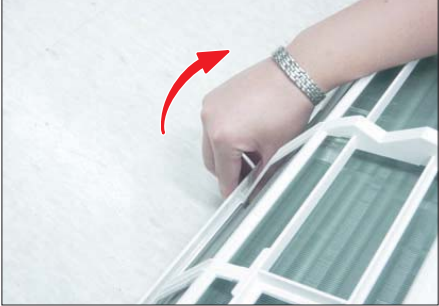
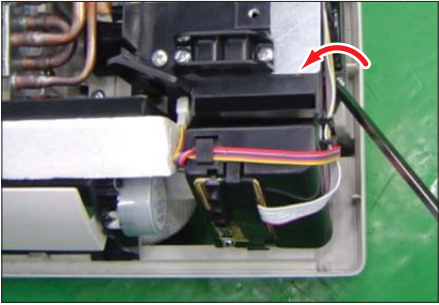
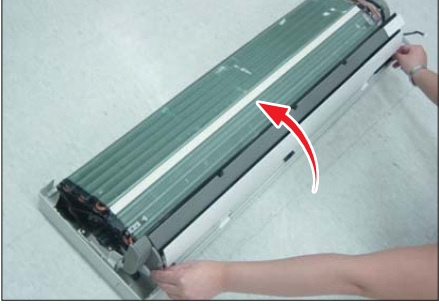

- All the procedure has to be verified because the cover should not open when the unit is installed.

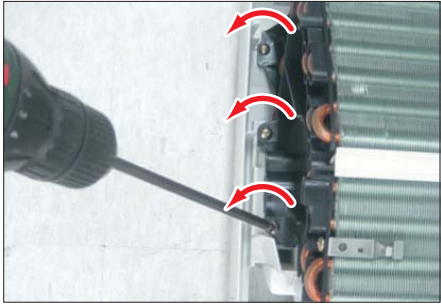
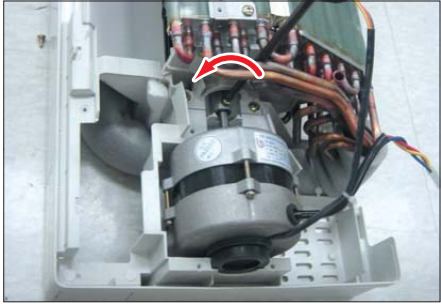
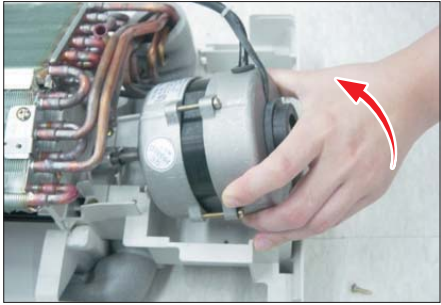







No	Parts	Procedure	Remark
1	Front Grille	<ol style="list-style-type: none"> 1) Stop the air conditioner operation and shut off the main power. 2) Open the Front Grille by pulling right and left sides of the hook. 3) Loosen 1 of the right screw(CCW) and detach the Terminal Cover. (Use +Screw Driver.) 4) Detach the thermistor from the Front Grille. 5) Loosen 2 fixing screws(CCW) of Front Grille. 6) Unlock 3 hooks to fix Panel Front and Tray Drain. (Use +Screw Driver.) 	    

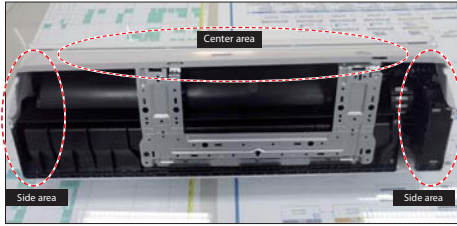

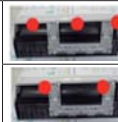

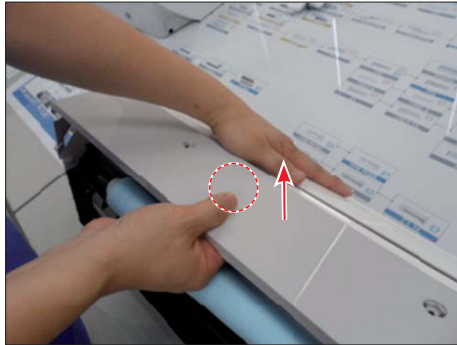
No	Parts	Procedure	Remark
		7) Unlock 3 hooks to fix Panel Front and Back-Body.	
2	Control-In (Main PCB)	1) Take all the connector of PCB upper side out. (Inclusion Power Cord) 2) Detach the outdoor unit connection wire from the Terminal Block. 3) Loosen 4 fixing screws(CCW) of Ass'y Control-In. (Use +Screw Driver.) ⚠ You can disassembly Ass'y Control In without evaporator disassembled.	
3	Tray Drain	1) Pull Tray Drain out from the Back Body.	

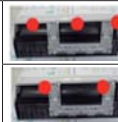
No	Parts	Procedure	Remark
4	Heat Exchanger	<ol style="list-style-type: none"> 1) Loosen 2 fixing earth screws(CCW) of right side. (Use +Screw Driver.) 2) Detach the Connection Pipe. 3) Detach the Holder Pipe at the rear side. 4) Loosen the 4 fixing screws(CCW) of right and left side. (Use +Screw Driver.) 5) Lifting the Heat Exchanger up a little to push the up side for separation from the indoor unit. <p style="color: red; font-weight: bold;">⚠ First, check Comp. Down and then disconnect the connection pipes before you disassemble the Evaporator from indoor unit.</p>	 
5	Fan Motor & Cross Fan	<ol style="list-style-type: none"> 1) Loosen the fixing screw(CCW). (Use +Screw Driver.) 2) Detach the Fan Motor from the Fan. 3) Detach the Fan From the left Holder Bearing. 	 

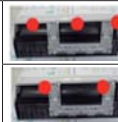
Wall Mounted type(A3050 With EEV)

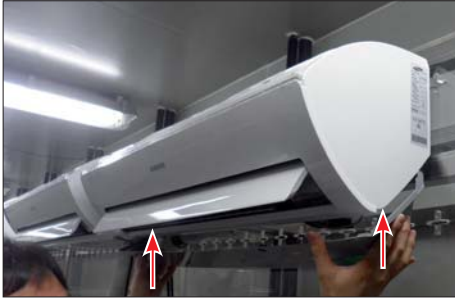

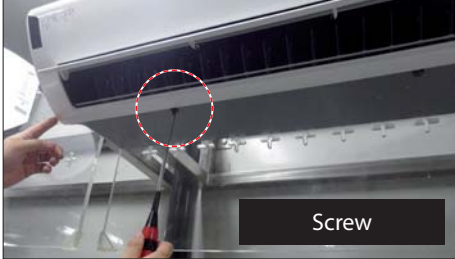

No	Parts	Procedure	Remark
1	PANEL-FRONT	<p>1) Stop the driving of air conditioner and shut off main power supply.</p> <p>2) Detach FILTER PRE from the PANEL FRONT.</p> <p>3) Cover Panel is assembled on bottom of indoor unit as shown in the figure. Remove the Cap Screw as shown on the right side and then remove the screw and separate the Cover Panel.</p>	   

No	Parts	Procedure	Remark						
		<p>4) Cover Panel is fixed to body by Hook in center area and side area.</p> <p>5) Separate the hook after pushing both end of Cover Panel as shown in the figure. (Watch out for the damage of the hook)</p> <p>6) Raise front part upward obliquely as shown in the figure and then remove the hooks.</p>	 <table border="1" data-bbox="938 555 1396 712"> <thead> <tr> <th colspan="2">HOOK</th> </tr> </thead> <tbody> <tr> <td>015/022/028/ 036/045</td> <td></td> </tr> <tr> <td>056/071/082</td> <td></td> </tr> </tbody> </table>   	HOOK		015/022/028/ 036/045		056/071/082	
HOOK									
015/022/028/ 036/045									
056/071/082									

No	Parts	Procedure	Remark
		<p>⚠ Caution: Assembly of Cover Panel after service end.</p> <ul style="list-style-type: none"> - Reassembly is in the reverse order of the removal. - Piping and drain hose must be careful not to damage and Progress must be done with both hands. 	    

No	Parts	Procedure	Remark
		<p>7) To detach the PANEL-FRONT from the main frame, unfasten 2 screws at the bottom. (use + Screw Driver)</p> <p>8) To detach the COVER-PANEL from the main frame, loosen 4 HOOK Structures. When separate the hook : Use the (-) screw Driver. (-)Screw Driver Insert the hook and then pull the hook as shown on the right side. (Watch out for the damage of the hook)</p>	   

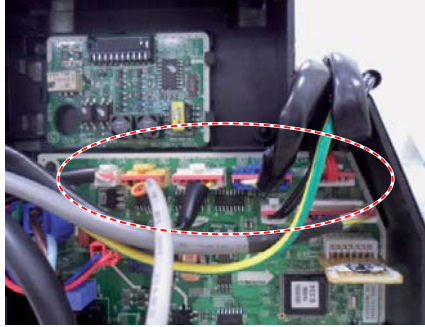
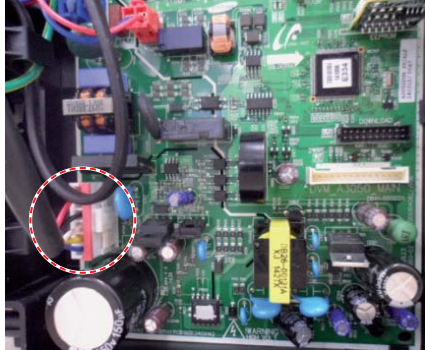
No	Parts	Procedure	Remark
		<p>9) Remove the Panel Frame from the Main Frame as shown on the right side.</p>	



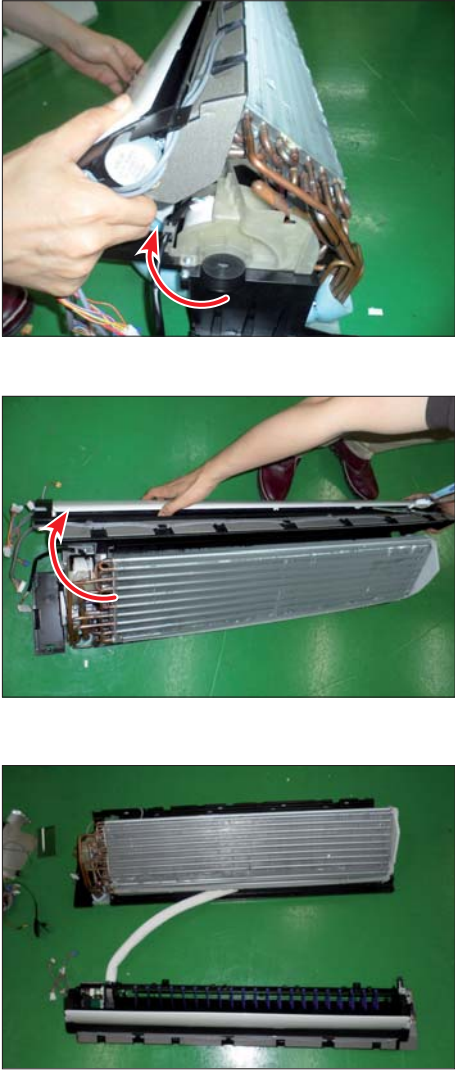

No	Parts	Procedure	Remark
2	CONTORL IN	<p>1) Lossen Sub PBA Wire.</p> <p>⚠ Caution: When you separate the connector, pull pressing the locking button.</p> <p>2) Lossen Stepping Motor, EEV, Display, Sensor, SPI, Fuse Wire.</p> <p>⚠ Caution: When you separate the connector, pull pressing the locking button.</p> <p>3) Lossen Motor, Terminal Wire.</p> <p>⚠ Caution: When you separate the connector, pull pressing the locking button.</p> <p>4) Loosen Earth Wire.</p>	    

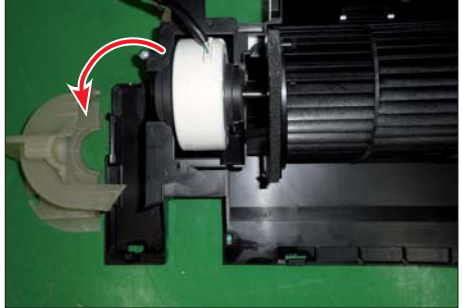
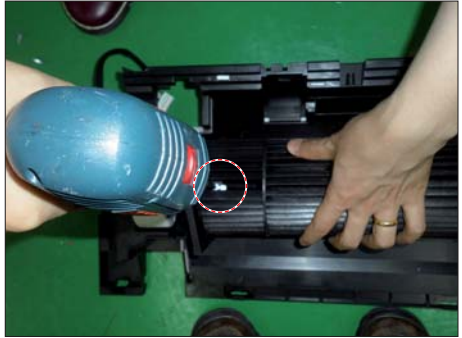
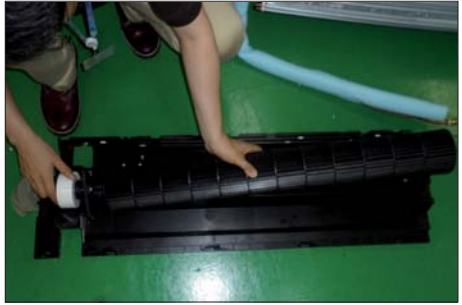
No	Parts	Procedure	Remark
5	EVAPORATOR	9) Take off the CASE-CONTROL from the main frame after loosen the remaining connector. ⚠ Caution: When you separate the connector, pull pressing the locking button.	
3	TRAY DRAIN	1) To detach TRAY-DRAIN from the main frame, pull the bottom of the TRAY-DRAIN towards you.	





No	Parts	Procedure	Remark
4	Evaporator	<p>1) Detach the HOLDER PIPE.</p> <p>2) Unfasten the screw at the left side. (use + Screw Driver)</p> <p>3) Unfasten the screw at the right side. (use + Screw Driver)</p> <p>4) To detach Evaporator from the main frame, pull the bottom of the Evaporator towards you.</p>	   



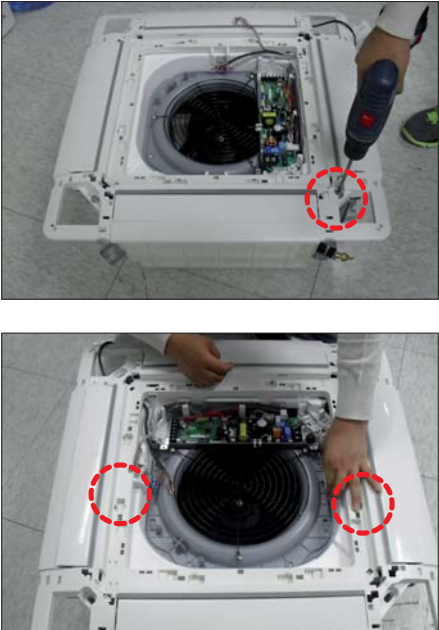
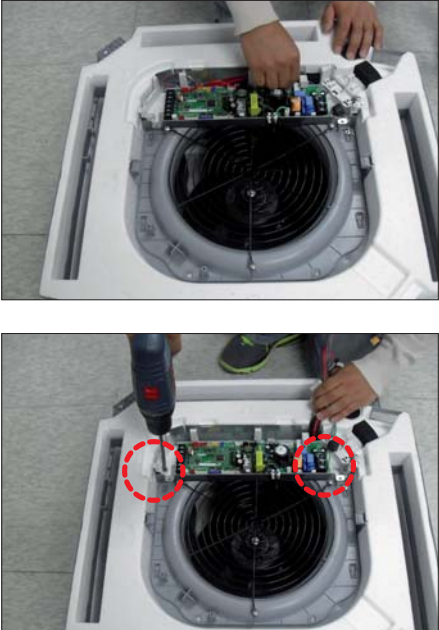

No	Parts	Procedure	Remark
5	FAN MOTOR & CROSS FAN	<p>1) Unfasten the screw. (use + Screw Driver)</p> <p>2) Detach the FAN Motor case.</p> <p>3) Unfasten the screw a little. (use + Screw Driver)</p> <p>4) Pull the CROSS-FAN to the left side.</p>	   

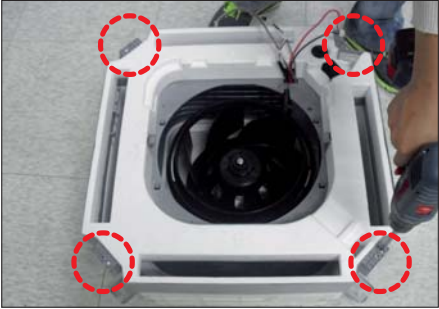



■ Global Mini 4way

No	Parts	Procedure	Remark
1	Panel	<ol style="list-style-type: none"> 1) Pull both hooks and take the grille downward. Two safety clips are mounted to the front grille to prevent it from dropping. 2) Detach the safety clip and take up the grille. 3) Remove the 2 fixed screws to remove the Control-Box Cover. (Use +Screw Driver) 4) Remove the Remocon-Receiver and Blade Connector Wire from the PBA. (3EA) 5) Push the 4 panel corners and cover downwards to remove it. 	    

No	Parts	Procedure	Remark
		<p>6) Disassemble the bolts that are assembled with the indoor unit at the 4 panel corners.</p> <p>7) Press the Hangers at both sides of the panel inwards, to remove it from the indoor unit's hook. Remove the panel from the indoor unit.</p>	
2	Control-Box	<p>1) Disconnect the Connector Wire that is connected to the indoor unit's PBA</p> <p>2) Unscrew the 2 fixed screws on both sides of the Control Box, and disassemble the Control Box from the indoor unit. (Use +Screw Driver)</p>	

No	Parts	Procedure	Remark
3	Bell-Mouth	<p>1) Unscrew the screw fixed on the Bell-Mouth. (Use +Screw Driver)</p> <p>2) Push the Bell-Mouth in the direction opposite to where it's installed on the Control-Box to remove it.</p>	 
4	Drain Pan	<p>1) Unscrew the screws on the 4 corners of the indoor unit. (Use +Screw Driver)</p> <p>2) Remove the Drain Pan from the indoor unit.</p>	 



No	Parts	Procedure	Remark
5	Drain Pump & Hose	<p>1) Remove the 2 fixed screws and disconnect the white drainage hose from the Drain Pump. (Use +Screw Driver)</p> <p>2) Remove the 2 screws and take the Drain-Hose out from the indoor unit to disassemble the transparent Drain-Hose fixed on the side of the indoor unit. (Use +Screw Driver)</p>	  
6	Evap. Temperature Sensor	<p>1) Use your hand to remove the temperature sensor attached to the Evap Pipe along with the fixing clip.</p>	

No	Parts	Procedure	Remark
7	Fan & Motor	<p>1) Turn the hexagonal nut attached to the top of the Fan counterclockwise to remove it. Take the Fan out of the Motor.</p> <p>2) Turn the three hexagonal nuts on the Motor counterclockwise to remove the nuts. Take the Motor Wires attached to these three locations out with your hands prior to removing the Motor.</p>	  
8	Evaporator	<p>1) Remove the screws of the Steel Holder Evaps that are used to fix the Heat Exchanger, and then remove it. (Use +Screw Driver)</p> <p>2) Remove the 2 fixing screws of the Partition Evap at the Heat Exchanger's In/Out Pipe. (Use +Screw Driver)</p>	 



No	Parts	Procedure	Remark
		<p>3) Remove the screw of the Cover Pipe that is used to fix the In/Out Pipe. Remove the In/Out Pipe. (Use +Screw Driver)</p> <p>4) Remove the Heat Exchanger from the indoor unit's cabinet.</p>	  

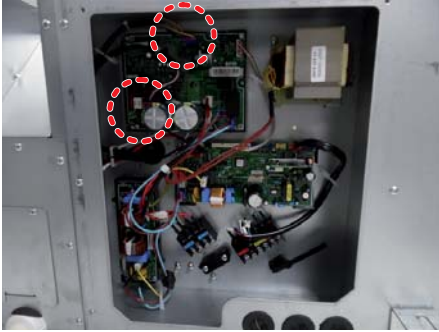
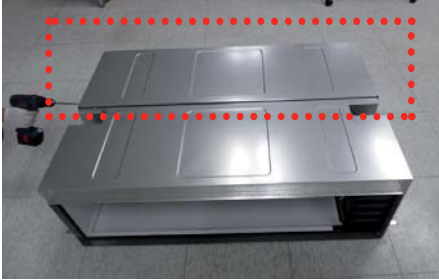
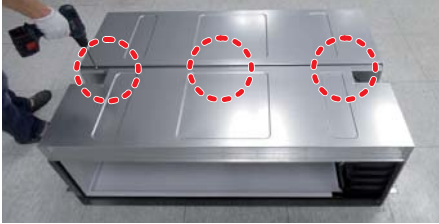

■ GD-S(Big Duct)

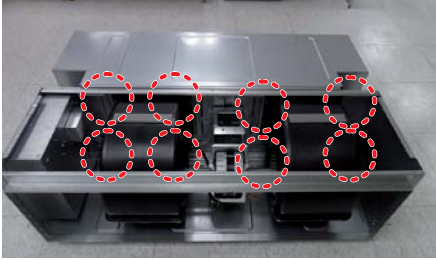
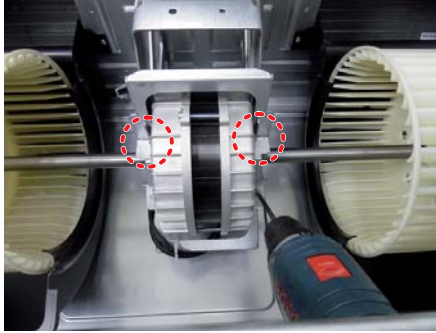
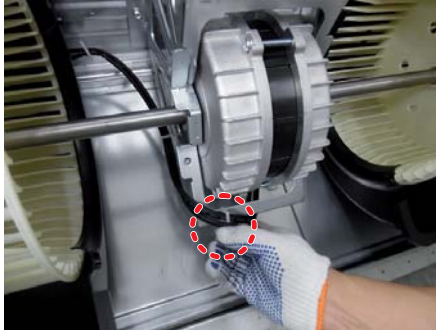
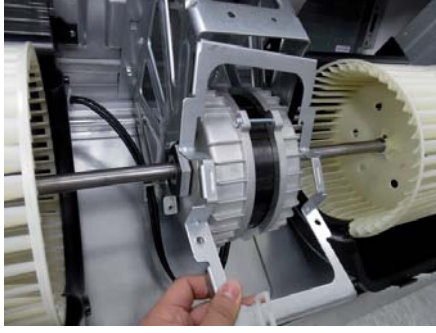
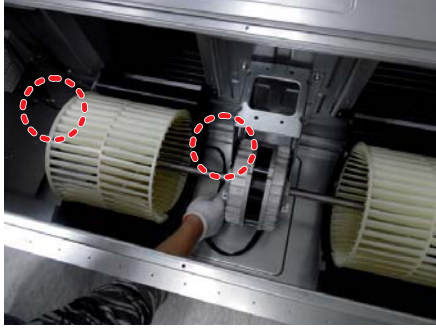
No	Parts	Procedure	Remark
1	Commom	<p>1) Disasseble the Cover Control. - Unscrew 2 screws.</p> <p>⚠ You must turn off the Power before disassembly.</p>	



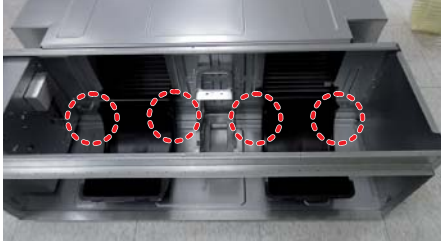
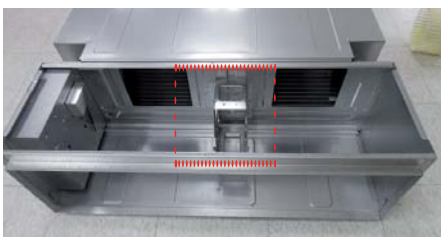

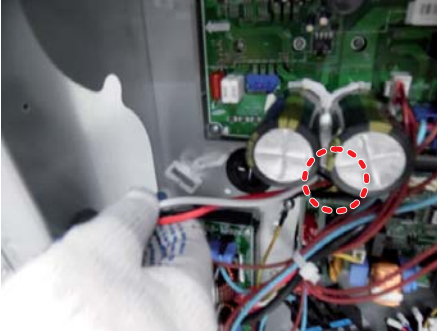
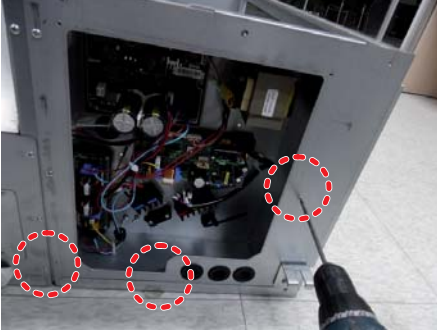
No	Parts	Procedure	Remark
2	Motor & Fan	<p>1) Disassemble the connection wire to take the motor fan out</p> <p>2) Disassemble th Cabinet Top Fan. - Unscrew 6 screws</p> <p>3) Disassemble the Link Screw. - Unscrew 3 screws</p> <p>4) Disassemble Cabinet Top Fan.</p>	    

No	Parts	Procedure	Remark
		<p>5) Disassemble 2 Case Blower Top. - Unscrew 8 screws</p> <p>6) Disassemble 1 Holder Motor. - Unscrew 2 screws</p> <p>7) Disassemble Motor wire from 2 holder wire,</p>	    

No	Parts	Procedure	Remark
		<p>8) After disassemble the Motor and Blower for the set, disassemble the Blower by use of 3mm wrench.</p>	 
		<p>9) Disassemble 2 Case blower bottom. - Unscrew 4 screws.</p>	
		<p>10) Disassemble the Bracket Motor. - Unscrew 4 screws.</p>	



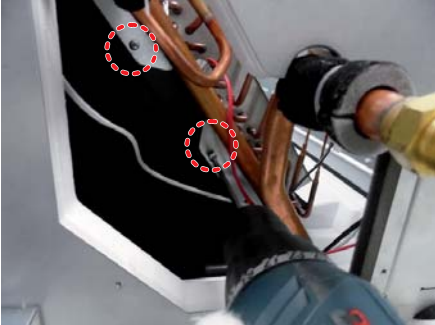

No	Parts	Procedure	Remark
3	Control Box	<p>1) Disassemble Evap Sensor wire and EEV wire(20kW only)</p> <p>2) Disassemble the Case Control. - Unscrew 3 screws</p>	  

No	Parts	Procedure	Remark
4	Evap	<p>1) Disassemble The Case Evap Top.</p> <ul style="list-style-type: none"> - [AC***JNHFKH]Unscrew 8 screws. - [AC***JNHPKH]Unscrew 6 screws. <p>2) Disassemble The Cushion Front.</p> <p>3) Disassemble The Cushion Support.</p> <ul style="list-style-type: none"> - Unscrew 1 screw 	

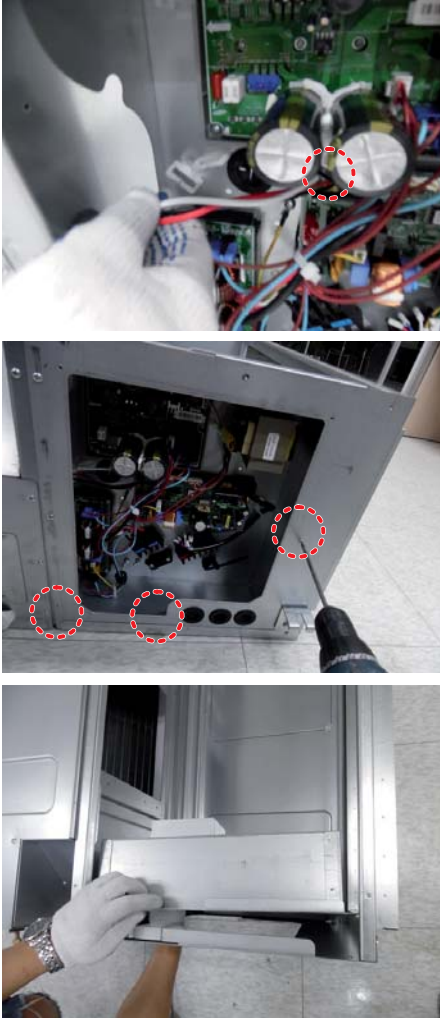
No	Parts	Procedure	Remark
		<p>4) Disassemble The Cover pipe. - Unscrew 3 screws</p> <p>5) Remove The cable tie on the Support Evap.</p> <p>6) Disassemble The Evap. - Unscrew 4 screws</p>	    

No	Parts	Procedure	Remark
		<p>1) Disassemble the connection wire to take the motor fan out.</p> <p>2) Disassemble The Cabi Fan Bottom. - Unscrew 9 screws.</p> <p>3) Disassemble the Link Screw. - Unscrew 3 screws</p> <p>4) Disassemble 2 Case blower bottom. - Unscrew 4 screws</p> <p>5) Disassemble Bracket Motor and Motor. - Unscrew 4 screws</p> <p>6) After disassemble the Motor and Blower for the set, disassemble the Blower by use of 3mm wrench.</p>	      

No	Parts	Procedure	Remark
2	Control Box	1) Disassemble Evap Sensor wire and EEV wire(20kW only) 2) Disassemble the Case Control. - Unscrew 3 screws	

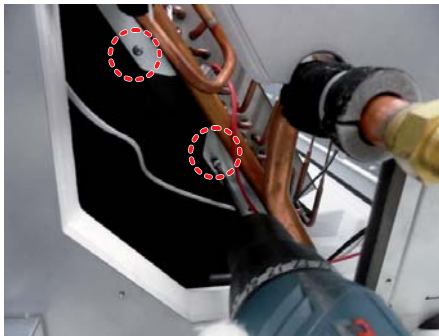
No	Parts	Procedure	Remark
3	Evap	<p>1) Disassemble The Case Evap Bottom. - [AC***JNHFKH]Unscrew 11 screws. - [AC***JNHPKH]Unscrew 7 screws.</p> <p>2) Disassemble The Drain Pan.</p> <p>3) Disassemble The Cover pipe. - Unscrew 3 screws</p> <p>4) Remove The cable tie on the Support Evap.</p> <p>5) Disassemble The Support Evap. - Unscrew 2 screws</p>	    

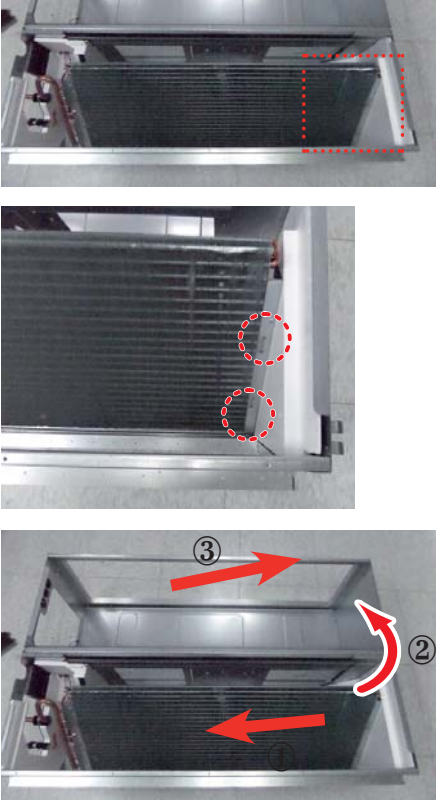
No	Parts	Procedure	Remark
		<p>6) Disassemble The Evap. - Unscrew 2 screws.</p> <p>① Moving the Evap 2~5cm to pipe direction.</p> <p>② Holding the pipe side and then rotating the opposite side.</p> <p>③ Moving the Evap in the direction of the arrow 3.</p>	

4. Troubleshooting

4-1 Check-up Window Description

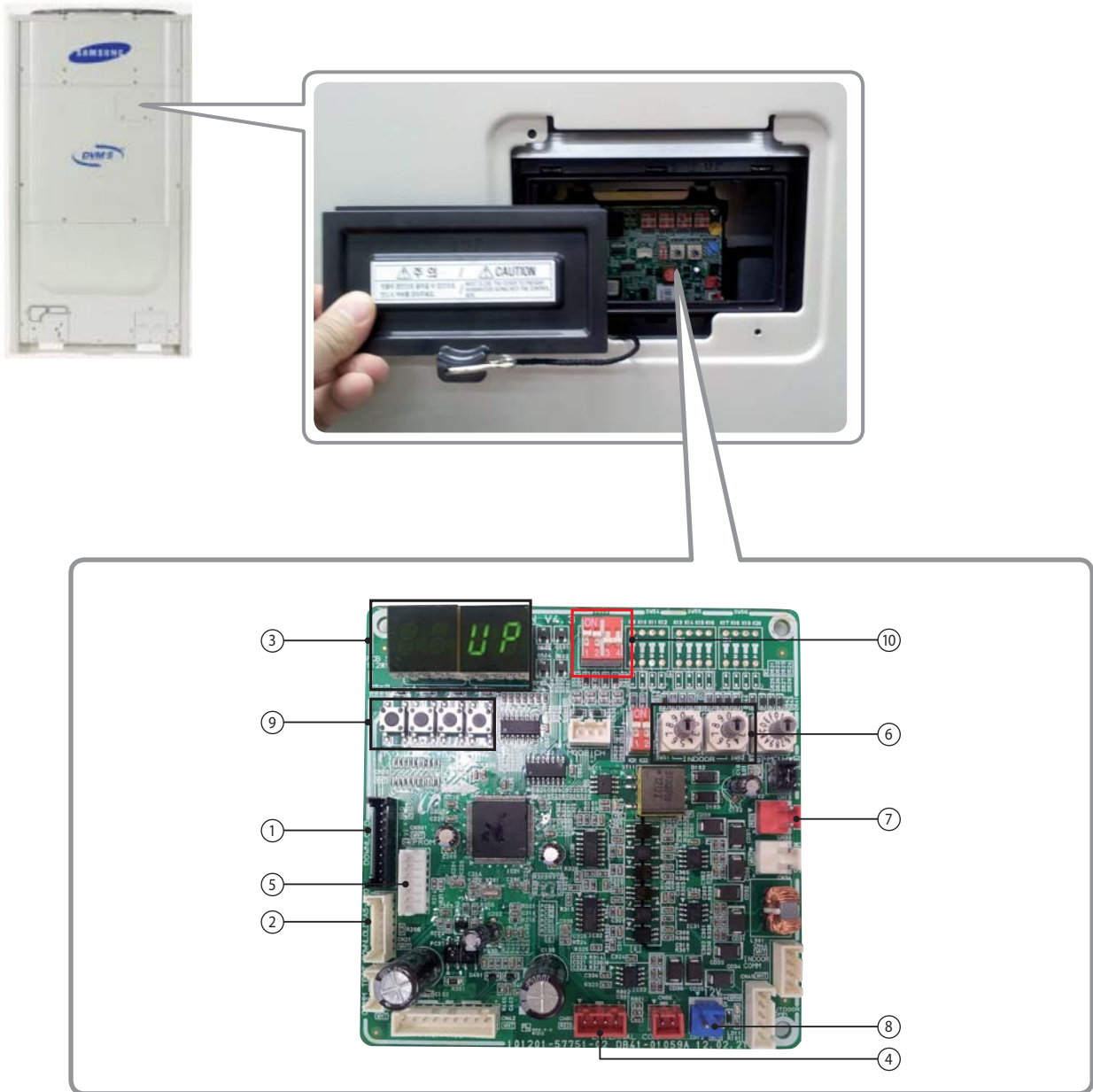

No.	Function	No.	Function
1	CN22 download (PC) (SMW200-10 black)	6	Set up the number of connected outdoor units
2	MICOM. download (AS-PRO) (SMW200-07P white)	7	For checking indoor unit communication (YW396-02P red)
3	ERROR DISPLAY	8	Transmitter 12V (YW396-02P blue)
4	State Check (SMW250-04P red)	9	Outdoor Unit Tact Switch
5	EEPROM SOCKET	10	Outdoor Unit Dip Switch

4-2 Service Operation

4-2-1 Special Operation

- Key input of the outdoor unit when the service enters the operation mode.

K1 (Number of press)	Key operation	Display on segment
1 time	Refrigerant charging in Heating mode	K, 1, BLANK, BLANK
2 times	Trial operation in Heating mode	K, 2, BLANK, BLANK
3 times	Pump out in Heating mode (Outdoor unit address 1)	K, 3, BLANK, 1
4 times	Pump out in Heating mode (Outdoor unit address 2)	K, 3, BLANK, 2
5 times	Pump out in Heating mode (Outdoor unit address 3)	K, 3, BLANK, 3
6 times	Pump out in Heating mode (Outdoor unit address 4)	K, 3, BLANK, 4
7 times	Vacuumig (Outdoor unit address 1)	K, 4, BLANK, 1
8 times	Vacuumig (Outdoor unit address 2)	K, 4, BLANK, 2
9 times	Vacuumig (Outdoor unit address 3)	K, 4, BLANK, 3
10 times	Vacuumig (Outdoor unit address 4)	K, 4, BLANK, 4
11 times	Vacuuming (All outdoor units)	K, 4, BLANK, A
12 times	End Key operation	-
Press and hold 1 time	Auto trial operation	K, K, BLANK, BLANK

K2 (Number of press)	Key operation	Display on segment
1 time	Refrigerant charging in Cooling mode	K, 5, BLANK, BLANK
2 times	Trial operation in Cooling mode	K, 6, BLANK, BLANK
3 times	Pump down all units in Cooling mode	K, 7, BLANK, BLANK
4 times	H/R: Checking the pipe connection H/P: Automatic setting of operation mode (Cooling/Heating) for trail operation	K, 8, BLANK, BLANK
5 times	Checking the amount of refrigerant	"K" "9" X X (Display of last two digits may differ depending on the progress)
6 times	Discharge mode of DC link voltage	K, A, BLANK, BLANK
7 times	Forced defrost operation	K, B, BLANK, BLANK
8 times	Forced oil collection	K, C, BLANK, BLANK
9 times	End Key operation	-

- ※ Inv1 & Inv2 voltage during discharge mode are displayed alternately.
- ※ Outdoor Power Off even when the Inverter PCB, Fan PCB is a high DC voltage charging contacts at danger.
- ※ When you run the repair and replacement of the PCB should work after the power is turned off, the DC voltage discharge.
(Natural discharge until Please wait for at least 15 minutes.)
- ※ If an error occurs, the discharge mode may not work properly.
In particular, E464 & E364 is power devices can be damaged.
Therefore, the discharge mode, do not use.

■ Commissioning

- ▶ After initial installation, stable operation for a certain period of time limited to operation conditions.

	Cooling	Heating
Method of Entry	K2 Tact Switch twice	K2 Tact Switch twice
Compressor	Normal operation, but the maximum frequency limit (differ by model)	
Indoor Unit	Whole operation (The set temperature=3°C)	Whole operation (The set temperature=40°C)
Outdoor fan and valves	Normally control conduct	
Operation time	Min : 60 minutes, Max : 10 hours	
Etc.	<ul style="list-style-type: none"> · Exceed the maximum operating time at stops and waits. · Protection and control, self-diagnosis is performed. 	

■ Refrigerant filling operation

- ▶ Operation to filling the refrigerant compressor was fixed at a certain frequency.

	Cooling	Heating
Method of Entry	K2 Tact Switch one time	K1 Tact Switch one time
Compressor	Starting frequency (Mild Start frequency) operation	
Indoor Unit	Whole operation (The set temperature=3°C)	Whole operation (The set temperature=40°C)
Outdoor fan and valves	Normally control conduct	
Operation time	60 minutes	
Etc.	During the filling operation does not enter the special operation, such as oil recovery, defrost.	

■ Heating Pump Out

- ▶ Operation for the repair of the Individual outdoor unit, the outdoor unit refrigerant emissions to the indoor part.
- ▶ Liquid pipe service valve and the gas pipe service valve operation, the operator manually need to close.
- ▶ Observe low pressure using View Mode of K4 button if compressor operate.
If low pressure goes down below about 0.2 MPa.g : Immediately lock the gas side service valve, Pump Out operation is shut down.
(Pump out operation shut down : K1 button once more press or K3 button one time press)
- ▶ If operation of low pressure goes down below 0.1 MPa.g : Will be stopped automatically for the protection of the compressor.

How to Initiate	K1 Tact Switch 3 times~6 times
Compressor	60Hz
Indoor Unit	Whole Operation (The set temperature=40°C)
4Way Valve	ON (Heating Mode)
Outdoor Fan	Maximum air flow
Main EEV	Operation side : 700 Step (Stop side : 0 step)
Maximum Operation Time	10 minutes
Protection Control	Conduct the discharge temperature, high pressure control. (Low pressure protection control is not carried out) ※ Low pressure is outside normal limits : Operation is shut down after gas pipe manually closed.
Etc.	Entry after safety start. (Only the corresponding Outdoor Unit operation.) To pump out more than 2 : Except communication between Outdoor Unit of relevant set after working for one, remainder set makes Pump Out add.

■ Cooling Pump Down

- ▶ Recover the refrigerant of Indoor Unit and Piping to outdoor side.
- ▶ Liquid pipe service valve and the gas pipe service valve operation, the operator manually need to close.
- ▶ If the installation of the long pipe : Any refrigerant into the outdoor unit can not be recovered, therefore should use a separate container.
- ▶ Observe low pressure using View Mode of K4 button if compressor operate.
If low pressure goes down below about 0.2 MPa.g : Immediately lock the gas side service valve, Pump Out operation is shut down.
(Pump out operation shut down : K1 button once more press or K3 button one time press)
- ▶ If operation of low pressure goes down below 0.1 MPa.g : Will be stopped automatically for the protection of the compressor.

How to Initiate	K2 Tact Switch 3 times
Compressor	Address No.1 Outdoor Unit - 60Hz (Other Outdoor Unit COMP OFF)
Indoor Unit	Whole Operation (The set temperature=3°C)
4Way Valve	OFF (Cooling Mode)
Outdoor Fan	Maximum air flow
Main EEV	Operation side : 2000 Step , Stop side : 2000 step
Maximum Operation Time	30 minutes
Etc.	Does not conduct the operation of the special operation, and protection control. Pressure and temperature is outside normal limits : Operation is shut down after gas pipe manually closed.

■ Vacuum Operation

- ▶ Operation to facilitate vacuum to open the valve after the Outdoor Unit repair.

How to Initiate	K1 Tact Switch 7 times~11 times
Compressor	OFF
Indoor Unit/Outdoor Fan	OFF
4Way Valve	OFF
Valves	Open all valves maximum
Etc.	If not turn off the vacuum mode, the start of normal operation is prohibited.

■ Piping Inspection Operation

- ▶ Operation mode to check the status of the piping between the MCU and the indoor unit.
- ▶ Heat Pump Model : Outdoor temperature is more than 15°C / Cooling commissioning start
Outdoor temperature is less than 15°C / Heating commissioning start

■ Discharge Mode Operation

- ▶ Outdoor power is turned off, the Inverter PCB and Fan PCB charging a high DC voltage, so dangerous to touch.
 - To replace the PCB, first turn off the power and the begin if DC voltage is discharged.
 - If not use the discharge mode, the discharge time of about 15 minutes takes.
 - If an error occurs, the discharge mode may not properly run. (Wait until natural discharge.)
 - In particular, E 464, E364, power devices may be damaged, therefore do not use the discharge mode.
- ▶ Block the Inverter PCB 3-phase relay after connected the power, and through compressor, DC voltage is discharging.
 - INV1 and INV2 DC voltage during discharge mode are displayed alternately.
 - Discharge mode Display (Rotate the three page display, as shown below.)
'K' 'A' ' ' ' ' → DC Link Volt1 (For example, 120[V] 0 1 2 0 display)
→ DCLinkVolt2 (For example, 120[V] 0 1 2 0 display) → 'K' 'A' ' ' ' ' → DC Link Volt1 ...
- ▶ Discharge is complete, the power of the Inverter PCB and Fan PCB is being blocked, communication function is blocked, E206 will occur.
- ▶ If want operation again after complete discharge mode : Restart after K3 key to Reset or Power Reset.

■ Forced defrost operation

- ▶ Forced defrost operation : Is operation when Frost Formation occurs in the outdoor. (When carried out the service)

Method of Entry	K2 Tact Switch 6 times
Start pattern	Heating commissioning pattern
Defrost start	Defrost start : It is after 10 minutes which Safety Start finishes.
Defrost off	General defrost operation conditions are the same as.
Etc.	Defrost shut down and stop the normal pattern of the outdoor unit stop.

■ Forced oil recovery operation

- ▶ Forced oil recovery operation : Oil recovery in the outdoor unit for the purpose of moving, installation if necessary.

Method of Entry	K2 Tact Switch 7 times
Start pattern	Outdoor temperature is more than 10°C : Cooling commissioning Outdoor temperature is less than 10°C : Heating commissioning
Oil recovery start	Oil recovery start : It is after 10 minutes which Safety Start finishes.
Etc.	Oil recovery shut down and stop the normal pattern of the outdoor unit stop.

4-2-2 DVM S Models EEPROM Code Table

No.	Model Name	EEP Code
1	AM080FXVAGH/TK	DB82-01358A
2	AM100FXVAGH/TK	DB82-01359A
3	AM120FXVAGH/TK	DB82-01360A
4	AM140FXVAGH/TK	DB82-01361A
5	AM160FXVAGH/TK	DB82-01362A
6	AM180FXVAGH/TK	DB82-01363A
7	AM200FXVAGH/TK	DB82-01364A
8	AM220FXVAGH/TK	DB82-01365A
9	AM080FXVAGR/TK	DB82-01330A
10	AM100FXVAGR/TK	DB82-01331A
11	AM120FXVAGR/TK	DB82-01332A
12	AM140FXVAGR/TK	DB82-01333A
13	AM160FXVAGR/TK	DB82-01334A
14	AM180FXVAGR/TK	DB82-01335A
15	AM200FXVAGR/TK	DB82-01336A
16	AM220FXVAGR/TK	DB82-01337A

4-3 Troubleshooting

4-3-1 Setting Option Setup Method



4-3-1-1 PCB option code input method

- ▶ Set the indoor unit address and installation option with remote controller option.
Set the each option separately since you cannot set the ADDRESS setting and indoor unit installation setting option at the same time. You need to set twice when setting indoor unit address and installation option.

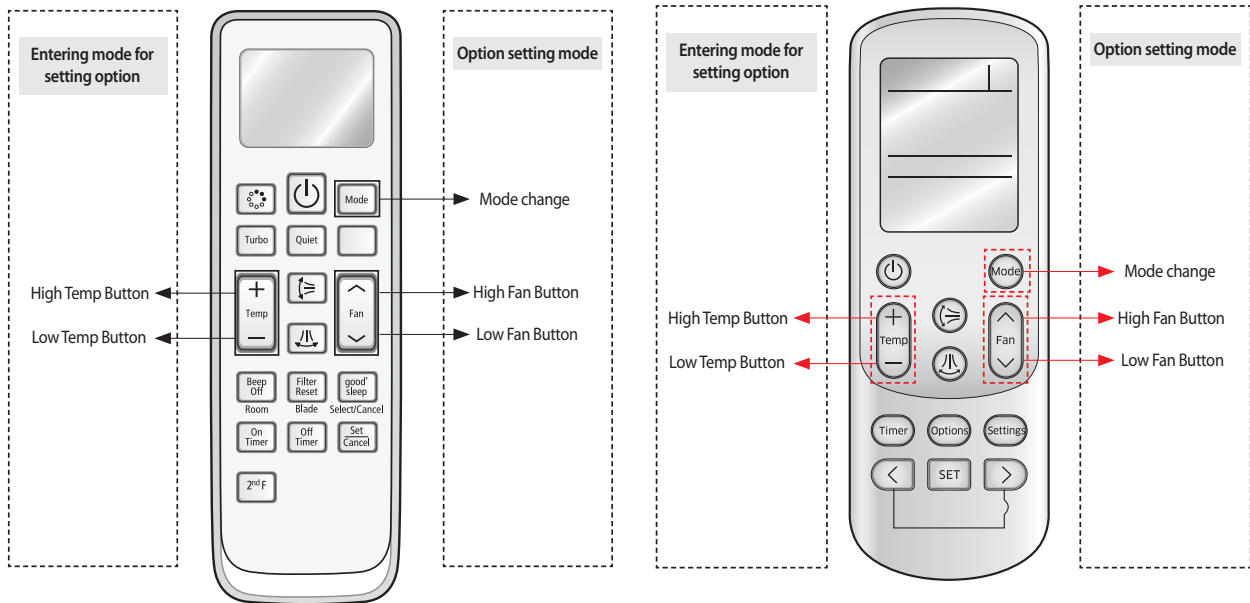
■ The procedure of setting option



Step 1 Entering mode to set option

1. Remove batteries from the remote controller.
2. Insert batteries and enter the option setting mode while pressing High Temp button and Low Temp button .
3.  Check if you have entered the option setting status.

Step 2 The procedure of option setting

After entering the option setting status, select the option as listed below.











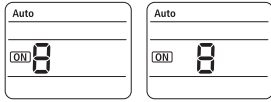

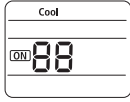
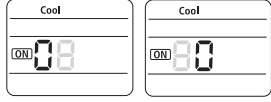
- The total number of available options are 24: SEG1 to SEG24.
- Because SEG1, SEG7, SEG13, and SEG19 are the page options used by the previous remote control models, the modes to set values for these options are skipped automatically.
- Set a 2-digit value for each option pair in the following order: SEG2 and SEG3 → SEG4 and SEG5 → SEG6 and SEG8 → SEG9 and SEG10 → SEG11 and SEG12 → SEG14 and SEG15 → SEG16 and SEG17 → SEG18 and SEG20 → SEG21 and SEG22 → SEG23 and SEG24.

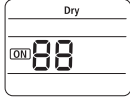
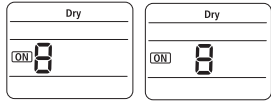

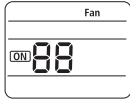
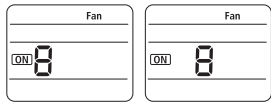

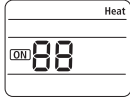
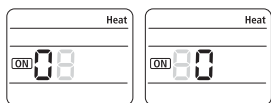

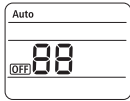

SEG1	SEG2	SEG3	SEG4	SEG5	SEG6	SEG7	SEG8	SEG9	SEG10	SEG11	SEG12
0	X	X	X	X	X	1	X	X	X	X	X
SEG13	SEG14	SEG15	SEG16	SEG17	SEG18	SEG19	SEG20	SEG21	SEG22	SEG23	SEG24
2	X	X	X	X	X	3	X	X	X	X	X

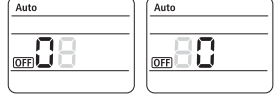
On(SEG1~12)	Off(SEG13~24)
Auto	Auto
00	00

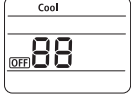
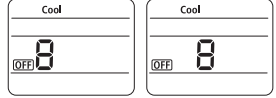
■ The procedure of setting option

Option setting	Status
<p>1. Setting SEG2, SEG3 option Press Low Fan button(∨) to enter SEG2 value. Press High Fan button(∧) to enter SEG3 value. Each time you press the button, 0 → 1 → ... 8 → F will be selected in rotation.</p>	
<p>2. Setting Cool mode  Press Mode button to be changed to Cool mode in the ON status.</p>	
<p>3. Setting SEG4, SEG5 option Press Low Fan button(∨) to enter SEG4 value. Press High Fan button(∧) to enter SEG5 value. Each time you press the button, 0 → 1 → ... 8 → F will be selected in rotation.</p>	
<p>4. Setting Dry mode  Press Mode button to be changed to DRY mode in the ON status.</p>	
<p>5. Setting SEG6, SEG8 option Press Low Fan button(∨) to enter SEG6 value. Press High Fan button(∧) to enter SEG8 value. Each time you press the button, 0 → 1 → ... 8 → F will be selected in rotation.</p>	
<p>6. Setting Fan mode  Press Mode button to be changed to FAN mode in the ON status.</p>	
<p>7. Setting SEG9, SEG10 option Press Low Fan button(∨) to enter SEG9 value. Press High Fan button(∧) to enter SEG10 value. Each time you press the button, 0 → 1 → ... 8 → F will be selected in rotation.</p>	
<p>8. Setting Heat mode  Press Mode button to be changed to HEAT mode in the ON status.</p>	
<p>9. Setting SEG11, SEG12 option Press Low Fan button(∨) to enter SEG11 value. Press High Fan button(∧) to enter SEG12 value. Each time you press the button, 0 → 1 → ... 8 → F will be selected in rotation.</p>	
<p>10. Setting Auto mode  Press Mode button to be changed to AUTO mode in the OFF status.</p>	

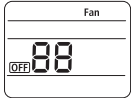
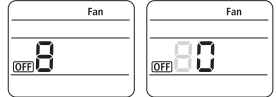
■ The procedure of setting option (cont.)

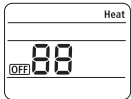
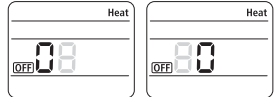
Option setting	Status
<p>11. Setting SEG14, SEG15 option Press Low Fan button(∨) to enter SEG14 value. Press High Fan button(∧) to enter SEG15 value. Each time you press the button, $\text{OFF} \rightarrow \text{OFF} \rightarrow \dots \text{E} \rightarrow \text{F}$ will be selected in rotation.</p>	 <p style="text-align: center;">SEG14 SEG15</p>
<p>12. Setting Cool mode  Press Mode button to be change to Cool mode in the OFF status.</p>	
<p>13. Setting SEG16, SEG17 option Press Low Fan button(∨) to enter SEG16 value. Press High Fan button(∧) to enter SEG17 value. Each time you press the button, $\text{OFF} \rightarrow \text{OFF} \rightarrow \dots \text{E} \rightarrow \text{F}$ will be selected in rotation.</p>	 <p style="text-align: center;">SEG16 SEG17</p>
<p>14. Setting Dry mode  Press Mode button to be change to Dry mode in the OFF status.</p>	
<p>15. Setting SEG18, SEG20 option Press Low Fan button(∨) to enter SEG18 value. Press High Fan button(∧) to enter SEG20 value. Each time you press the button, $\text{OFF} \rightarrow \text{OFF} \rightarrow \dots \text{E} \rightarrow \text{F}$ will be selected in rotation.</p>	 <p style="text-align: center;">SEG18 SEG20</p>
<p>16. Setting Fan mode  Press Mode button to be change to Fan mode in the OFF status.</p>	
<p>17. Setting SEG21, SEG22 option Press Low Fan button(∨) to enter SEG21 value. Press High Fan button(∧) to enter SEG22 value. Each time you press the button, $\text{OFF} \rightarrow \text{OFF} \rightarrow \dots \text{E} \rightarrow \text{F}$ will be selected in rotation.</p>	 <p style="text-align: center;">SEG21 SEG22</p>
<p>18. Setting Heat mode  Press Mode button to be change to HEAT mode in the OFF status.</p>	
<p>19. Setting SEG23, SEG24 mode Press Low Fan button(∨) to enter SEG23 value. Press High Fan button(∧) to enter SEG24 value. Each time you press the button, $\text{OFF} \rightarrow \text{OFF} \rightarrow \dots \text{E} \rightarrow \text{F}$ will be selected in rotation.</p>	

Step 3 Check the option you have set

After setting option, press  button to check whether the option code you input is correct or not.

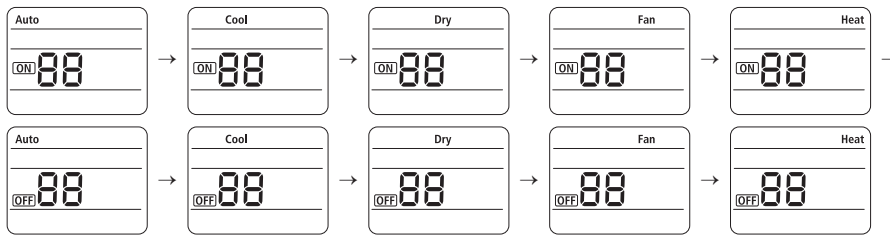

Step 4 Input option

Press operation button  with the direction of remote control for set.
For the correct option setting, you must input the option twice.

Step 5 Check operation

1. Reset the indoor unit by pressing the RESET button of indoor unit or outdoor unit.
2. Take the batteries out of the remote controller and insert them again and then press the operation button.

- Setting an indoor unit address and installation option

■ Setting an indoor unit installation option (suitable for the condition of each installation location)

1. Check whether power is supplied or not.
 - When the indoor unit is not plugged in, there should be additional power supply in the indoor unit.
2. The panel(display) should be connected to an indoor unit to receive option.
3. Set the installation option according to the installation condition of an air conditioner.
 - The default setting of an indoor unit installation option is 020010-100000-200000-300000.
 - Individual control of a remote controller(SEG20) is the function that controls an indoor unit individually when there is more than one indoor unit.

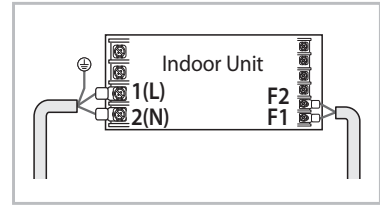

4. Set the indoor unit option by wireless remote controller.

SEG1	SEG2	SEG3	SEG4	SEG5	SEG6
0	2	RESERVED	Exterior temperature sensor	Central control	FAN RPM compensation
SEG7	SEG8	SEG9	SEG10	SEG11	SEG12
1	Drain pump	Hot water heater	Electronic heater	Opening the electronic expansion valve	Master / Slave
SEG13	SEG14	SEG15	SEG16	SEG17	SEG18
2	External control	External control output	S-Plasma ion	Buzzer	Number of hours using filter
SEG19	SEG20	SEG21	SEG22	SEG23	SEG24
3	Individual control of a remote controller	Heating setting compensation	EEV opening of an indoor unit stopped during oil return or Defrost operation.	-	Human sensor

- ▶ 1WAY/2WAY/4WAY MODEL : Drain pump(SEG8) will be set to 'USE + 3minute delay' even if the drain pump is set to 0.
- ▶ 1 WAY/2WAY/4WAY,DUCT MODEL : Number of hours using filter(SEG18) will be set to '1000hour' even if the SEG18 is set to except for 2 or 6.
- ▶ If you input a number other than 0~4 of the individual control of the indoor unit(SEG20), the indoor is set as indoor 1.
- ▶ SEG5 central control option is basically set as 1 (Use), so you don't need to set the central control option additionally. However, if the central control is not connected but it doesn't indicate an error message, you need to set the central control option as 0 (Disuse) to exclude the indoor unit from the central control.

Option No. : 02XXXX-1XXXX-2XXXX-3XXXX

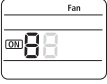
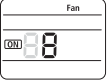
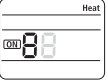
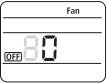
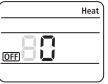
Option	SEG1		SEG2		SEG3		SEG4		SEG5		SEG6	
Explanation	PAGE		MODE		Use of robot cleaning		Use of external temperature sensor		Use of central control		FAN RPM compensation	
Remote Controller Display												
Indication and Details	Indication	Details	Indication	Details	Indication	Details	Indication	Details	Indication	Details	Indication	Details
	0		2		0	Disuse	0	Disuse	0	Disuse	0	Disuse
					1	Use	1	Use	1	Use	1	Use
											2	High ceiling KIT
Option	SEG7		SEG8		SEG9		SEG10		SEG11		SEG12	
Explanation	PAGE		Use of drain pump		Use of hot water heater		Use of electronic heater		Opening the electronic expansion valve of an indoor unit when heating operation stops.		Master / Slave	
Remote Controller Display												
Indication and Details	Indication	Details	Indication	Details	Indication	Details	Indication	Details	Indication	Details	Indication	Details
	1		0	Disuse	0	Disuse	0	Disuse	0	0	0	slave
			1	Use	1	Use	1	Use	1	80	1	master
2			Use + 3minute delay									
Option	SEG13		SEG14		SEG15		SEG16		SEG17		SEG18	
Explanation	PAGE		Use of external control		Setting the output of external control		S-Plasma ion		Buzzer control		Number of hours using filter	
Remote Controller Display												
Indication and Details	Indication	Details	Indication	Details	Indication	Details	Indication	Details	Indication	Details	Indication	Details
	2		0	Disuse	0	Thermo on	0	Disuse	0	Mixed operation control1/Use buzzer	2	1000 Hour
			1	ON/OFF Control	1	Operation on	1	Use	1	Mixed operation control1/Disuse of buzzer	6	2000 Hour
			2	OFF Control					2	Mixed operation control2/Use buzzer		
3	Mixed operation control2/Disuse of buzzer											
Option	SEG19		SEG20		SEG21		SEG22		SEG23		SEG24	
Explanation	PAGE		Individual control of a remote controller		Heating setting compensation		EEV opening of an indoor unit stopped during oil return or defrost operation.		-		Human sensor	
Remote Controller Display												
Indication and Details	Indication	Details	Indication	Details	Indication	Details	Indication	Details	Indication	Details	Indication	Details
	3		0 or 1	channel 1	0	Disuse	0	150 step			8	Disuse
			2	channel 2	1	2°C	1	0 step			9	Use
			3	channel 3	2	5°C						
4			channel 4									

► 360 cassette

You cannot set both of the indoor unit addresses and the installation options in a batch: set both of them respectively.

Common steps for setting the addresses and options

AR-KH00E remote control (for 360 cassette only)

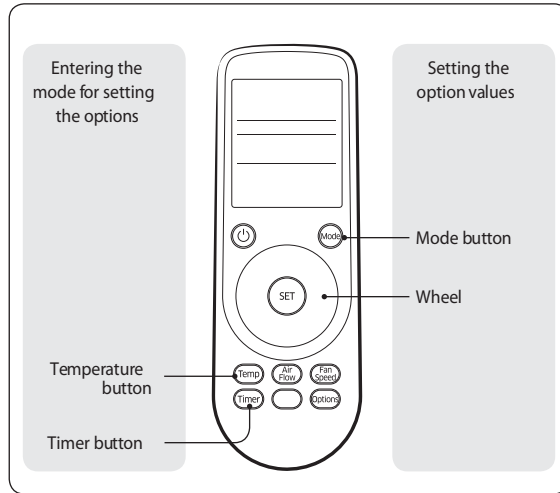

NOTE
The remote control display may vary depending on the model.

1. Enter the mode for setting the options:
 - a. Remove the batteries from the remote control.
 - b. While holding down the **Temp** (Temp) and **Timer** (Timer) buttons simultaneously, insert the batteries into the remote control.
 - c. Make sure that you are entered to the mode for setting the options:

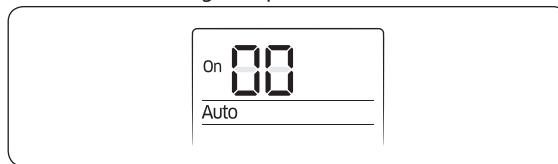

2. Set the option values.







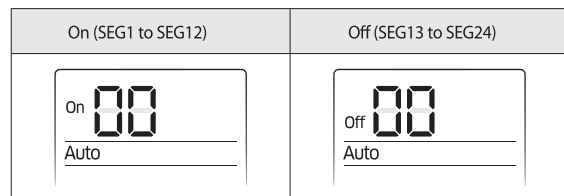



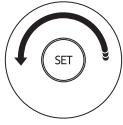
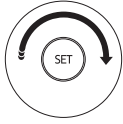

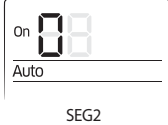
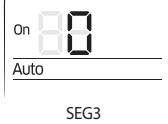
CAUTION

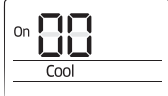
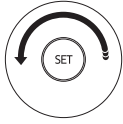
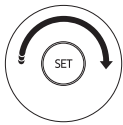

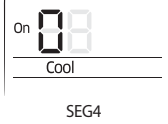
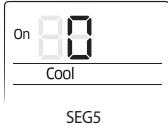

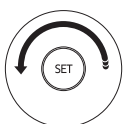
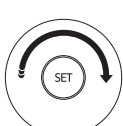

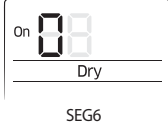
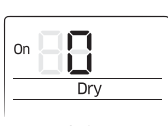



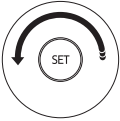
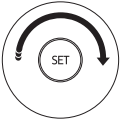

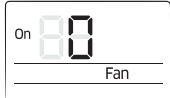

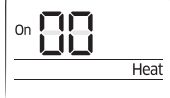
- The total number of available options are 24: SEG1 to SEG24.
- Because SEG1, SEG7, SEG13, and SEG19 are the page options used by the previous remote control models, the modes to set values for these options are skipped automatically.
- Set a 2-digit value for each option pair in the following order: SEG2 and SEG3 → SEG4 and SEG5 → SEG6 and SEG8 → SEG9 and SEG10 → SEG11 and SEG12 → SEG14 and SEG15 → SEG16 and SEG17 → SEG18 and SEG20 → SEG21 and SEG22 → SEG23 and SEG24.

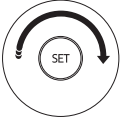



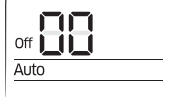
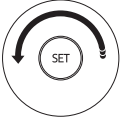
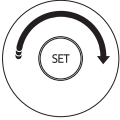

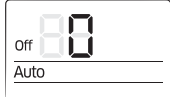

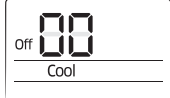
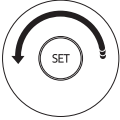
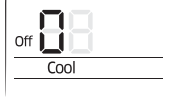

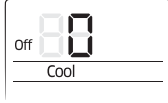





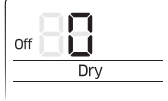

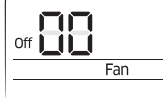
SEG1	SEG2	SEG3	SEG4	SEG5	SEG6
0	X	X	X	X	X
SEG7	SEG8	SEG9	SEG10	SEG11	SEG12
1	X	X	X	X	X
SEG13	SEG14	SEG15	SEG16	SEG17	SEG18
2	X	X	X	X	X
SEG19	SEG20	SEG21	SEG22	SEG23	SEG24
3	X	X	X	X	X

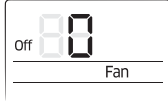

Take the steps presented in the following table:

Steps	Remote control display
<p>1 Set the SEG2 and SEG3 values:</p> <p>a Set the SEG2 value by rotating the Wheel counterclockwise until the value you want to set appears on the remote control display.</p>  <p>b Set the SEG3 value by rotating the Wheel clockwise until the value you want to set appears on the remote control display.</p>  <p>When you rotate the Wheel, values appear in the following order: </p>	 <p>SEG2</p>  <p>SEG3</p>
<p>2 Press the  (Mode) button. Cool and On appear on the remote control display.</p>	
<p>3 Set the SEG4 and SEG5 values:</p> <p>a Set the SEG4 value by rotating the Wheel counterclockwise until the value you want to set appears on the remote control display.</p>  <p>b Set the SEG5 value by rotating the Wheel clockwise until the value you want to set appears on the remote control display.</p>  <p>When you rotate the Wheel, values appear in the following order: </p>	 <p>SEG4</p>  <p>SEG5</p>
<p>4 Press the  (Mode) button. Dry and On appear on the remote control display.</p>	
<p>5 Set the SEG6 and SEG8 values:</p> <p>a Set the SEG6 value by rotating the Wheel counterclockwise until the value you want to set appears on the remote control display.</p>  <p>b Set the SEG8 value by rotating the Wheel clockwise until the value you want to set appears on the remote control display.</p>  <p>When you rotate the Wheel, values appear in the following order: </p>	 <p>SEG6</p>  <p>SEG8</p>
<p>6 Press the  (Mode) button. Fan and On appear on the remote control display.</p>	

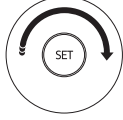
Steps	Remote control display
<p>7 Set the SEG9 and SEG10 values:</p> <p>a Set the SEG9 value by rotating the Wheel counterclockwise until the value you want to set appears on the remote control display.</p>  <p>b Set the SEG10 value by rotating the Wheel clockwise until the value you want to set appears on the remote control display.</p>  <p>When you rotate the Wheel, values appear in the following order: 0 → 1 → ... E → F</p>	 <p>SEG9</p>  <p>SEG10</p>
<p>8 Press the  (Mode) button. Heat and On appear on the remote control display.</p>	
<p>9 Set the SEG11 and SEG12 values:</p> <p>a Set the SEG11 value by rotating the Wheel counterclockwise until the value you want to set appears on the remote control display.</p>  <p>b Set the SEG12 value by rotating the Wheel clockwise until the value you want to set appears on the remote control display.</p>  <p>When you rotate the Wheel, values appear in the following order: 0 → 1 → ... E → F</p>	 <p>SEG11</p>  <p>SEG12</p>
<p>10 Press the  (Mode) button. Auto and Off appear on the remote control display.</p>	
<p>11 Set the SEG14 and SEG15 values:</p> <p>a Set the SEG14 value by rotating the Wheel counterclockwise until the value you want to set appears on the remote control display.</p>  <p>b Set the SEG15 value by rotating the Wheel clockwise until the value you want to set appears on the remote control display.</p>  <p>When you rotate the Wheel, values appear in the following order: 0 → 1 → ... E → F</p>	 <p>SEG14</p>  <p>SEG15</p>
<p>12 Press the  (Mode) button. Cool and Off appear on the remote control display.</p>	
<p>13 Set the SEG16 and SEG17 values:</p> <p>a Set the SEG16 value by rotating the Wheel counterclockwise until the value you want to set appears on the remote control display.</p> 	 <p>SEG16</p>

Steps	Remote control display
<p>b Set the SEG17 value by rotating the Wheel clockwise until the value you want to set appears on the remote control display.</p>  <p>When you rotate the Wheel, values appear in the following order: $\square \rightarrow \text{H} \rightarrow \dots \text{E} \rightarrow \text{F}$</p>	 <p>SEG17</p>
<p>14 Press the  (Mode) button. Dry and Off appear on the remote control display.</p>	
<p>15 Set the SEG18 and SEG20 values:</p> <p>a Set the SEG18 value by rotating the Wheel counterclockwise until the value you want to set appears on the remote control display.</p>  <p>b Set the SEG20 value by rotating the Wheel clockwise until the value you want to set appears on the remote control display.</p>  <p>When you rotate the Wheel, values appear in the following order: $\square \rightarrow \text{H} \rightarrow \dots \text{E} \rightarrow \text{F}$</p>	 <p>SEG18</p>  <p>SEG20</p>
<p>16 Press the  (Mode) button. Fan and Off appear on the remote control display.</p>	
<p>17 Set the SEG21 and SEG22 values:</p> <p>a Set the SEG21 value by rotating the Wheel counterclockwise until the value you want to set appears on the remote control display.</p>  <p>b Set the SEG22 value by rotating the Wheel clockwise until the value you want to set appears on the remote control display.</p>  <p>When you rotate the Wheel, values appear in the following order: $\square \rightarrow \text{H} \rightarrow \dots \text{E} \rightarrow \text{F}$</p>	 <p>SEG21</p>  <p>SEG22</p>
<p>18 Press the  (Mode) button. Heat and Off appear on the remote control display.</p>	
<p>19 Set the SEG23 and SEG24 values:</p> <p>a Set the SEG23 value by rotating the Wheel counterclockwise until the value you want to set appears on the remote control display.</p>  <p>b Set the SEG24 value by rotating the Wheel clockwise until the value you want to set appears on the remote control display.</p>  <p>When you rotate the Wheel, values appear in the following order: $\square \rightarrow \text{H} \rightarrow \dots \text{E} \rightarrow \text{F}$</p>	 <p>SEG23</p>  <p>SEG24</p>

3. Check whether the option values that you have set are correct by pressing the  (Mode) button repeatedly.

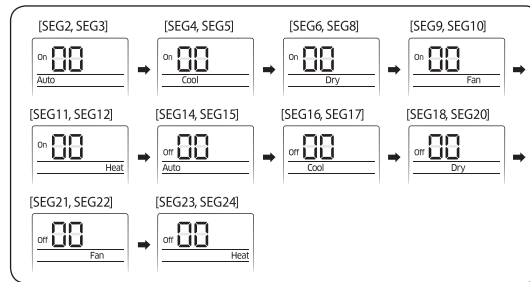

4. Save the option values into the indoor unit: Point the remote control to the remote control sensor on the indoor unit and then press the  (Power) button on the remote control twice. Make sure that this command is received by the indoor unit. When it is successfully received, you can hear a short sound from the indoor unit.

If the command is not received, press the  (Power) button again.

5. Check whether the air conditioner operates in accordance with the option values you have set:

- a. Reset the indoor unit by disconnecting and then reconnecting the power cable of the indoor unit or by pressing the RESET button on the outdoor unit.
- b. Remove the batteries from the remote control, insert them again, and then press the  (Power) button on the remote control.

 NOTE

- If the fan is set to off for cooling only indoor unit by setting the SEG9=3 or SEG15=3, you need to use an external sensor or wired remote control sensor to detect indoor temperature exactly..

Installation options for the O2 series

SEG1	SEG2	SEG3	SEG4	SEG5	SEG6
0	2	-	Use of external temperature sensor / Minimizing fan operation when thermostat is off	Use of central control	Compensation of the fan RPM
SEG7	SEG8	SEG9	SEG10	SEG11	SEG12
1	Use of drain pump	Use of hot water heater	-	EEV step when heating stops	-
SEG13	SEG14	SEG15	SEG16	SEG17	SEG18
2	Use of external control	Setting the output of external control / External heater On or Off signal	-	Buzzer control	Maximum filter usage time
SEG19	SEG20	SEG21	SEG22	SEG23	SEG24
3	Individual control with remote control	Heating setting compensation offset / Removing condensated water in the Heat mode	EEV step of stopped unit during the oil return or the defrost mode	Motion detection sensor	Cycle time of Swing

- Even if you set the Use of drain pump (SEG8) option to 0, it is automatically set to 2 (the drain pump is used with 3 minute delay).
- If you set the Maximum filter usage time (SEG18) option to a value other than 2 and 6, it is automatically set to 2 (1000 hours).
- If you set an option to a value that is out of range specified above, the option is automatically set to 0 by default.
- The SEG5 option (Use of central control) is set to 1 (Use) by default. Therefore, you don't need to set the SEG5 option additionally. Note that even if the central control system is not connected, no errors occur. If you want a specific indoor unit not to be controlled by the central control system, set the SEG option of that indoor unit to 0 (Disuse).
- The external output of SEG15 is generated via MIM-B14 connection. (Refer to the manual of MIM-B14.)
- If you set the Individual control with remote control (SEG20) option to a value other than 0 to 4, it is automatically set to 0 (Indoor 1).

Installation options for the O2 series (detailed)

Option No. for an indoor unit address: 02XXXX-1XXXXX-2XXXXX-3XXXXX

Option	SEG1		SEG2		SEG3		SEG4			SEG5		SEG6								
Function	Page		Mode		-		Use of external temperature sensor / Minimizing fan operation when thermostat is off			Use of central control		Compensation of the fan RPM								
Indication and details	Indication	Details	Indication	Details	-		Indication	Details		Indication	Details	Indication	Details							
									Use of external temperature sensor					Minimizing fan operation when thermostat is off						
		0		2		-		0	Disuse	(Cooling, Heating) Disuse	0	Disuse	0	Disuse (recessed installation)						
								1	Use	(Cooling, Heating) Disuse										
								2	Disuse	(Heating) Use (*2)	1	Use	1	Use	1	High-ceiling mode (recessed installation)				
								3	Use	(Heating) Use (*2)										
								4	Disuse	(Cooling) Use										
														5	Use	(Cooling) Use			4	Disuse (exposed installation)
														6	Disuse	(Cooling, Heating) Use (*2)			5	High-ceiling mode (exposed installation)
													7	Use	(Cooling, Heating) Use (*2)					

Option	SEG7		SEG8		SEG9		SEG10			SEG11		SEG12	
Function	Page		Use of drain pump		Use of hot water heater		-			EEV step when heating stops		-	
Indication and detail	Indication	Details	Indication	Details	Indication	Details	-			Indication	Details	-	
			0	Disuse	0	Disuse				0	Default		
		1	1	Use	1	Use (*3)				1	Noise decreasing setting		
			2	Use with 3 minute delay	2	-							

Option	SEG13		SEG14		SEG15			SEG16		SEG17		SEG18		
Function	Page		Use of external control		Setting the output of external control / External heater On or Off signal			S-Plasma ion		Buzzer control		Maximum filter usage time		
Indication and details	Indication	Details	Indication	Details	Indication	Details		Indication	Details	Indication	Details	Indication	Details	
						Setting the output of external control	External heater On or Off signal							
				0	Disuse	0	Thermo On	-	0	Disuse	0	Use of buzzer	2	1000 hours
				1	ON or OFF control	1	Operation On	-						
				2	OFF control	2	-	Use (*4)	1	Use	1	Disuse of buzzer	6	2000 hours
			3	Window ON or OFF control	3	-	Use (*4)							
Option	SEG19		SEG20		SEG21			SEG22		SEG23		SEG24		
Function	Page		Individual control with remote control		Heating setting compensation offset / Removing condensated water in the Heat mode			EEV step of stopped unit during the oil return or the defrost mode		Motion detection sensor		Cycle time of Swing		
Indication and details	Indication	Details	Indication	Details	Indication	Details		Indication	Details	Indication	Details	Indication	Details	
						Heating setting compensation offset	Removing condensated water in the Heat mode							
				0 or 1	Indoor 1	0	Default (*5)	Disuse	0	Default	0	Disuse	0	34 seconds (default)
						1	2 °C	Disuse			1	Turn out in 30 min. without motion	1	30 seconds
				2	Indoor 2	2	5 °C	Disuse	1	Oil return or Noise decreasing in defrost mode	2	Turn out in 60 min. without motion	2	38 seconds

Indication and details	3	3	Indoor 3	3	Default (*5)	Use (*6)	1	Oil return or Noise decreasing in defrost mode	2	Turn out in 60 min. without motion	2	38 seconds
		4	Indoor 4	4	2 °C	Use (*6)			3	Turn out in 120 min. without motion		
				5	5 °C	Use (*6)			5	Turn out in 180 min. without motion		
		4	Indoor 4	5	5 °C	Use (*6)			6	Turn out in 60 min. without motion or advanced function (*1)		
									7	Turn out in 120 min. without motion or advanced function (*1)		
									8	Turn out in 180 min. without motion or advanced function (*1)		

(*1) Advanced function: Either controlling the cooling or heating current or power saving with motion detection.

(*2) Minimizing fan operation when thermostat is off :

The fan operates for 20 seconds at an interval of 5 minutes in the Heat mode.

(*3) 1: The fan is turned on continually when the hot water heater is turned on,

3: The fan is turned off when the hot water heater is turned on with cooling only indoor unit.

(Cooling only indoor unit: To use this option, install the Mode Select switch (MCM-C200) on the outdoor unit and fix it to the Cool mode.)

(*4) When the following 2 or 3 is used as external heater On or Off signal, the signal for monitoring external contact control will not be output.

2: The fan is turned on continually when the external heater is turned on,

3: The fan is turned off when the external heater is turned on with cooling only indoor unit

(Cooling only indoor unit: To use this option, install the Mode Select switch (MCM-C200) on the outdoor unit and fix it to the Cool mode.)

(*5) Default setting value: 5 °C

(*6) If the air conditioner operates in the Heat mode immediately after finishing the cooling operation, the condensated

water in the drain pan becomes water steam by the heat of the indoor unit heat exchanger. Since the water steam

might be condensed on the indoor unit, which may fall into a living space, use this function to remove the water steam

out of the indoor unit by operating the fan (for maximum 20 minutes) although the indoor unit is turned off after the

Cool mode is turned to the Heat mode.

Installation options for the 05 series

SEG1	SEG2	SEG3	SEG4	SEG5	SEG6
0	5	Use of the HR-specific auto changeover function in the Auto mode	(When setting SEG3) Offset for the heating reference temperature	(When setting SEG3) Offset for the cooling reference temperature	(When setting SEG3) Reference for change from Heat mode to Cool mode
SEG7	SEG8	SEG9	SEG10	SEG11	SEG12
1	(When setting SEG3) Reference for change from Cool mode to Heat mode	(When setting SEG3) Time required for mode change	Compensation option for a long pipe and the height difference between indoor units	-	-
SEG13	SEG14	SEG15	SEG16	SEG17	SEG18
2	-	-	-	-	Control variables when the hot water heater or an external heater is used
SEG19	SEG20	SEG21	SEG22	SEG23	SEG24
3	-	-	-	-	-

4-3-2 Option Items

Item	Model	SEG																								Static Pressure
		1	2	3	4	5	6	7	8	9	10	11	12	13	14	15	16	17	18	19	20	21	22	23	24	
Slim 1-Way Cassette	AM022FN1DEH/TK	0	1	7	0	4	4	1	1	8	0	C	8	2	0	1	6	1	6	3	3	0	0	1	0	
	AM028FN1DEH/TK	0	1	7	0	4	4	1	1	8	0	F	8	2	0	1	C	1	C	3	3	0	0	1	0	
	AM036FN1DEH/TK	0	1	7	0	4	4	1	1	5	4	5	D	2	0	2	4	2	4	3	3	0	0	1	0	
	AM056JN1DEH/TK	0	1	8	0	4	4	1	9	5	4	3	C	2	0	3	8	3	8	3	3	0	0	1	0	
	AM071JN1DEH/TK	0	1	8	0	4	4	1	9	5	4	5	F	2	0	4	7	4	7	3	3	0	0	1	0	
2-Way Cassette	AM056FN2DEH/TK	0	1	2	0	4	4	1	1	5	5	6	1	2	0	3	8	3	8	3	3	0	0	1	0	
	AM071FN2DEH/TK	0	1	2	0	4	4	1	1	5	5	8	2	2	0	4	7	4	7	3	3	0	0	1	0	
Global 4-Way Cassette	AM045FN4DEH/TK	0	1	4	0	4	F	1	9	5	0	9	7	2	0	2	D	2	D	3	3	0	0	0	0	
	AM056FN4DEH/TK	0	1	4	0	4	F	1	9	5	0	A	7	2	0	3	8	3	8	3	3	0	0	0	0	
	AM071FN4DEH/TK	0	1	4	0	4	F	1	9	4	0	D	8	2	0	4	7	4	7	3	3	0	0	0	0	
	AM090FN4DEH/TK	0	1	4	0	4	F	1	9	5	4	0	9	2	0	5	A	5	A	3	3	0	0	0	0	
	AM112FN4DEH/TK	0	1	4	0	4	F	1	9	5	4	1	B	2	0	7	0	7	0	3	3	0	0	1	0	
	AM128FN4DEH/TK	0	1	4	0	4	F	1	9	5	4	2	D	2	0	8	0	8	0	3	3	0	0	2	0	
	AM140FN4DEH/TK	0	1	4	0	4	F	1	9	5	4	4	F	2	0	8	C	8	C	3	3	0	0	2	0	
BIG Duct	AM220FNHDEH/TK	0	1	1	0	5	4	1	9	5	0	9	7	2	0	D	C	D	C	3	1	1	1	1	0	5mmAq
		0	1	1	0	5	4	1	9	5	0	C	7	2	0	D	C	D	C	3	1	1	1	1	0	10mmAq
		0	1	1	0	5	4	1	9	5	0	E	8	2	0	D	C	D	C	3	1	1	1	1	0	15mmAq
		0	1	1	0	5	4	1	9	5	4	4	D	2	0	D	C	D	C	3	1	1	1	1	0	20mmAq
		0	1	1	0	5	4	1	9	5	4	9	F	2	0	D	C	D	C	3	1	1	1	1	0	25mmAq
	AM280FNHDEH/TK	0	1	1	0	5	4	1	9	5	4	0	7	2	3	1	C	1	C	3	1	1	1	1	0	5mmAq
		0	1	1	0	5	4	1	9	5	4	2	9	2	3	1	C	1	C	3	1	1	1	1	0	10mmAq
		0	1	1	0	5	4	1	9	5	4	5	B	2	3	1	C	1	C	3	1	1	1	1	0	15mmAq
		0	1	1	0	5	4	1	9	5	4	9	E	2	3	1	C	1	C	3	1	1	1	1	0	20mmAq
		0	1	1	0	5	4	1	9	5	5	D	1	2	3	1	C	1	C	3	1	1	1	1	0	25mmAq
		0	1	1	0	5	4	1	9	5	5	F	3	2	3	1	C	1	C	3	1	1	1	1	0	28mmAq
Floor Standing	AM036FNFDEH/TK	0	1	A	0	5	4	1	0	5	0	0	0	2	0	2	4	2	4	3	3	0	0	1	0	
	AM056FNFDEH/TK	0	1	A	0	5	4	1	0	5	0	0	0	2	0	3	8	3	8	3	3	0	0	1	0	
	AM071FNFDEH/TK	0	1	A	0	5	4	1	0	5	0	0	0	2	0	4	7	4	7	3	3	0	0	1	0	
ERV Plus	AM050FNKDEH/TK	0	1	E	0	4	4	1	9	5	5	8	0	2	0	2	4	2	4	3	3	2	0	0	0	
	AM100FNKDEH/TK	0	1	E	0	4	4	1	9	5	5	7	3	2	0	4	7	4	7	3	3	2	0	2	0	
G-MINI 4-W/C	AM022FNNDEH/TK	0	1	5	0	4	F	1	9	7	0	E	8	2	0	1	6	1	6	3	3	0	0	0	0	
	AM028FNNDEH/TK	0	1	5	0	4	F	1	9	5	4	0	A	2	0	1	C	1	C	3	3	0	0	0	0	
	AM036FNNDEH/TK	0	1	5	0	4	F	1	9	3	4	2	C	2	0	2	4	2	4	3	3	0	0	0	0	
	AM045FNNDEH/TK	0	1	5	0	4	F	1	9	5	4	4	E	2	0	2	D	2	D	3	3	0	0	0	0	
	AM056FNNDEH/TK	0	1	5	0	4	F	1	9	5	4	7	F	2	0	3	8	3	8	3	3	0	0	0	0	
	AM060FNNDEH/TK	0	1	5	0	4	F	1	9	5	5	9	1	2	0	3	C	3	C	3	3	0	0	0	0	
SLIM DUCT-S	AM017FNLDEH/TK	0	1	0	0	5	4	1	2	5	4	9	E	2	0	1	1	1	1	3	3	1	1	1	0	0mmAq
		0	1	0	0	5	4	1	2	5	5	B	1	2	0	1	1	1	1	3	3	1	1	1	0	1mmAq
		0	1	0	0	5	4	1	2	5	5	F	5	2	0	1	1	1	1	3	3	1	1	1	0	3mmAq
	AM022FNLDEH/TK	0	1	0	0	5	4	1	2	5	E	0	8	2	0	1	6	1	6	3	1	1	1	1	0	3mmAq
		0	1	0	0	5	4	1	2	5	A	C	3	2	0	1	6	1	6	3	1	1	1	1	0	1mmAq
		0	1	0	0	5	4	1	2	5	A	8	0	2	0	1	6	1	6	3	1	1	1	1	0	0mmAq
	AM028FNLDEH/TK	0	1	0	0	5	4	1	2	5	E	7	A	2	0	1	C	1	C	3	1	1	1	1	0	3mmAq
		0	1	0	0	5	4	1	2	5	E	1	5	2	0	1	C	1	C	3	1	1	1	1	0	1mmAq
		0	1	0	0	5	4	1	2	5	A	E	2	2	0	1	C	1	C	3	1	1	1	1	0	0mmAq
	AM036FNLDEH/TK	0	1	0	0	5	4	1	2	5	E	C	D	2	0	2	4	2	4	3	1	1	1	1	0	3mmAq
		0	1	0	0	5	4	1	2	5	E	6	8	2	0	2	4	2	4	3	1	1	1	1	0	1mmAq
		0	1	0	0	5	4	1	2	5	E	3	5	2	0	2	4	2	4	3	1	1	1	1	0	0mmAq
SLIM DUCT-1	AM045FNLDEH/TK	0	1	0	0	5	4	1	2	5	E	F	6	2	0	2	D	2	D	3	1	1	1	1	0	4mmAq
		0	1	0	0	5	4	1	2	5	A	E	2	2	0	2	D	2	D	3	1	1	1	1	0	2mmAq
		0	1	0	0	5	4	1	2	5	9	9	F	2	0	2	D	2	D	3	1	1	1	1	0	0mmAq
	AM056FNLDEH/TK	0	1	0	0	5	4	1	2	5	E	F	9	2	0	3	8	3	8	3	1	1	1	1	0	4mmAq
		0	1	0	0	5	4	1	2	5	E	3	4	2	0	3	8	3	8	3	1	1	1	1	0	2mmAq
		0	1	0	0	5	4	1	2	5	A	C	1	2	0	3	8	3	8	3	1	1	1	1	0	0mmAq

Option Items(cont.)

Item	Model	SEG																							Static Pressure		
		1	2	3	4	5	6	7	8	9	10	11	12	13	14	15	16	17	18	19	20	21	22	23		24	
SLIM DUCT-2	AM071FNLDEH/TK	0	1	0	0	5	4	1	2	5	E	F	4	2	0	4	7	4	7	3	1	1	1	1	0	4mmAq	
		0	1	0	0	5	4	1	2	5	D	9	E	2	0	4	7	4	7	3	1	1	1	1	0	2mmAq	
		0	1	0	0	5	4	1	2	5	9	B	B	2	0	4	7	4	7	3	1	1	1	1	0	0mmAq	
SLIM DUCT-3	AM090FNLDEH/TK	0	1	0	0	5	4	1	B	5	E	2	A	2	0	5	A	5	A	3	1	1	1	1	0	6mmAq	
		0	1	0	0	5	4	1	B	5	A	D	4	2	0	5	A	5	A	3	1	1	1	1	0	3mmAq	
		0	1	0	0	5	4	1	B	5	9	6	C	2	0	5	A	5	A	3	1	1	1	1	0	0mmAq	
	AM112FNLDEH/TK	0	1	0	0	5	4	1	B	5	E	2	A	2	0	7	0	7	0	3	1	1	1	1	0	6mmAq	
		0	1	0	0	5	4	1	B	5	A	D	4	2	0	7	0	7	0	3	1	1	1	1	0	3mmAq	
		0	1	0	0	5	4	1	B	5	9	6	C	2	0	7	0	7	0	3	1	1	1	1	0	0mmAq	
	AM128FNLDEH/TK	0	1	0	0	5	4	1	B	5	E	8	F	2	0	8	0	8	0	3	1	1	1	1	0	6mmAq	
		0	1	0	0	5	4	1	B	5	E	4	B	2	0	8	0	8	0	3	1	1	1	1	0	3mmAq	
		0	1	0	0	5	4	1	B	5	A	F	5	2	0	8	0	8	0	3	1	1	1	1	0	0mmAq	
	AM140FNLDEH/TK	0	1	0	0	5	4	1	B	5	F	C	3	2	0	8	C	8	C	3	1	1	1	1	0	6mmAq	
		0	1	0	0	5	4	1	B	5	E	7	F	2	0	8	C	8	C	3	1	1	1	1	0	3mmAq	
		0	1	0	0	5	4	1	B	5	E	3	A	2	0	8	C	8	C	3	1	1	1	1	0	0mmAq	
SLIM DUCT-1 [Uplevel Static Pressure]	AM022FNMDEH/TK	0	1	0	0	5	4	1	3	5	5	E	4	2	0	1	6	1	6	3	1	1	1	1	0	6mmAq	
		0	1	0	0	5	4	1	3	5	4	1	E	2	0	1	6	1	6	3	1	1	1	1	0	4mmAq	
		0	1	0	0	5	4	1	3	5	0	E	A	2	0	1	6	1	6	3	1	1	1	1	0	2mmAq	
	AM028FNMDEH/TK	0	1	0	0	5	4	1	3	5	0	B	6	2	0	1	6	1	6	3	1	1	1	1	0	0mmAq	
		0	1	0	0	5	4	1	3	5	9	A	9	2	0	1	C	1	C	3	1	1	1	1	0	6mmAq	
		0	1	0	0	5	4	1	3	5	5	6	2	2	0	1	C	1	C	3	1	1	1	1	0	4mmAq	
	AM036FNMDEH/TK	0	1	0	0	5	4	1	3	5	4	2	C	2	0	1	C	1	C	3	1	1	1	1	0	2mmAq	
		0	1	0	0	5	4	1	3	5	0	E	8	2	0	1	C	1	C	3	1	1	1	1	0	0mmAq	
		0	1	0	0	5	4	1	3	5	4	C	F	2	0	2	4	2	4	3	1	1	1	1	0	6mmAq	
	MSP DUCT-S [Uplevel Static Pressure]	AM045FNMDEH/TK	0	1	0	0	5	4	1	3	5	4	2	C	2	0	2	4	2	4	3	1	1	1	1	0	4mmAq
			0	1	0	0	5	4	1	3	5	0	F	B	2	0	2	4	2	4	3	1	1	1	1	0	2mmAq
			0	1	0	0	5	4	1	3	5	0	E	A	2	0	2	4	2	4	3	1	1	1	1	0	0mmAq
MSP DUCT-S	AM056FNMDEH/TK	0	1	0	0	5	4	1	2	5	9	0	6	2	0	2	D	2	D	3	1	1	1	1	0	8mmAq	
		0	1	0	0	5	4	1	2	5	5	A	4	2	0	2	D	2	D	3	1	1	1	1	0	6mmAq	
		0	1	0	0	5	4	1	2	5	5	8	3	2	0	2	D	2	D	3	1	1	1	1	0	4mmAq	
	AM071FNMDEH/TK	0	1	0	0	5	4	1	2	5	5	7	1	2	0	2	D	2	D	3	1	1	1	1	0	2mmAq	
		0	1	0	0	5	4	1	2	5	5	7	1	2	0	3	8	3	8	3	1	1	1	1	0	0mmAq	
		0	1	0	0	5	4	1	2	5	9	5	7	2	0	3	8	3	8	3	1	1	1	1	0	8mmAq	
	MSP DUCT-0	AM090FNMDEH/TK	0	1	0	0	5	4	1	2	5	5	F	5	2	0	3	8	3	8	3	1	1	1	1	0	6mmAq
			0	1	0	0	5	4	1	2	5	5	C	5	2	0	3	8	3	8	3	1	1	1	1	0	4mmAq
			0	1	0	0	5	4	1	2	5	9	3	2	0	3	8	3	8	3	1	1	1	1	1	0	2mmAq
	HSP Duct	AM112FNHDEH/TK	0	1	0	0	5	4	1	2	5	D	F	C	2	0	4	7	4	7	3	1	1	1	1	0	8mmAq
			0	1	0	0	5	4	1	2	5	D	F	9	2	0	4	7	4	7	3	1	1	1	1	0	6mmAq
			0	1	0	0	5	4	1	2	5	9	7	9	2	0	4	7	4	7	3	1	1	1	1	0	4mmAq
AM128FNHDEH/TK		0	1	0	0	5	4	1	2	5	9	3	6	2	0	4	7	4	7	3	1	1	1	1	0	2mmAq	
		0	1	0	0	5	4	1	2	5	9	0	4	2	0	4	7	4	7	3	1	1	1	1	0	0mmAq	
		0	1	0	0	5	4	1	2	5	D	F	D	2	0	5	A	5	A	3	1	1	1	1	0	8mmAq	
HSP Duct		AM112FNHDEH/TK	0	1	0	0	5	4	1	3	5	5	4	0	2	0	7	0	7	0	3	3	1	1	1	0	5mmAq
			0	1	0	0	5	4	1	3	5	5	9	1	2	0	7	0	7	0	3	3	1	1	1	0	10mmAq
			0	1	0	0	5	4	1	3	5	9	1	6	2	0	7	0	7	0	3	3	1	1	1	0	15mmAq
	AM128FNHDEH/TK	0	1	0	0	5	4	1	3	5	A	E	A	2	0	7	0	7	0	3	3	1	1	1	0	20mmAq	
		0	1	0	0	5	4	1	3	5	5	C	5	2	0	8	0	8	0	3	3	1	1	1	0	5mmAq	
		0	1	0	0	5	4	1	3	5	5	C	5	2	0	8	0	8	0	3	3	1	1	1	0	10mmAq	
0	1	0	0	5	4	1	3	5	9	3	D	2	0	8	0	8	0	3	3	1	1	1	0	15mmAq			
0	1	0	0	5	4	1	3	5	E	1	8	2	0	8	0	8	0	3	3	1	1	1	0	20mmAq			

Option Items(cont.)

Item	Model	SEG																								Static Pressure
		1	2	3	4	5	6	7	8	9	10	11	12	13	14	15	16	17	18	19	20	21	22	23	24	
HSP Duct	AM140FNHDEH/TK	0	1	0	0	5	4	1	3	5	5	8	0	2	0	8	C	8	C	3	3	1	1	1	0	5mmAq
		0	1	0	0	5	4	1	3	5	9	1	9	2	0	8	C	8	C	3	3	1	1	1	0	10mmAq
		0	1	0	0	5	4	1	3	5	A	D	3	2	0	8	C	8	C	3	3	1	1	1	0	15mmAq
		0	1	0	0	5	4	1	3	5	F	6	0	2	0	8	C	8	C	3	3	1	1	1	0	20mmAq
MSP DUCT-1	AM112FNMDEH/TK	0	1	0	0	5	4	1	2	2	F	F	0	2	0	7	0	7	0	3	1	1	1	1	0	12mmAq
		0	1	0	0	5	4	1	2	2	F	F	0	2	0	7	0	7	0	3	1	1	1	1	0	10mmAq
		0	1	0	0	5	4	1	2	2	E	B	B	2	0	7	0	7	0	3	1	1	1	1	0	8mmAq
		0	1	0	0	5	4	1	2	2	E	2	6	2	0	7	0	7	0	3	1	1	1	1	0	6mmAq
		0	1	0	0	5	4	1	2	2	E	0	4	2	0	7	0	7	0	3	1	1	1	1	0	4mmAq
MSP DUCT-2	AM128FNMDEH/TK	0	1	0	0	5	4	1	2	2	E	3	6	2	0	8	0	8	0	3	1	1	1	1	0	14mmAq
		0	1	0	0	5	4	1	2	2	E	1	4	2	0	8	0	8	0	3	1	1	1	1	0	12mmAq
		0	1	0	0	5	4	1	2	2	E	E	2	2	0	8	0	8	0	3	1	1	1	1	0	10mmAq
		0	1	0	0	5	4	1	2	2	A	B	0	2	0	8	0	8	0	3	1	1	1	1	0	8mmAq
		0	1	0	0	5	4	1	2	2	9	9	E	2	0	8	0	8	0	3	1	1	1	1	0	6mmAq
		0	1	0	0	5	4	1	2	2	9	6	C	2	0	8	0	8	0	3	1	1	1	1	0	4mmAq
	AM140FNMDEH/TK	0	1	0	0	5	4	1	2	2	E	F	C	2	0	8	C	8	C	3	1	1	1	1	0	14mmAq
		0	1	0	0	5	4	1	2	2	E	A	A	2	0	8	C	8	C	3	1	1	1	1	0	12mmAq
		0	1	0	0	5	4	1	2	2	E	4	7	2	0	8	C	8	C	3	1	1	1	1	0	10mmAq
		0	1	0	0	5	4	1	2	2	E	2	4	2	0	8	C	8	C	3	1	1	1	1	0	8mmAq
		0	1	0	0	5	4	1	2	2	A	F	2	2	0	8	C	8	C	3	1	1	1	1	0	6mmAq
		0	1	0	0	5	4	1	2	2	9	C	F	2	0	8	C	8	C	3	1	1	1	1	0	4mmAq
	AM160KNMDEH/TK	0	1	0	0	5	4	1	2	5	E	F	E	2	0	A	0	A	0	3	3	1	1	1	0	14mmAq
		0	1	0	0	5	4	1	2	5	E	F	D	2	0	A	0	A	0	3	3	1	1	1	0	12mmAq
		0	1	0	0	5	4	1	2	5	E	F	C	2	0	A	0	A	0	3	3	1	1	1	0	10mmAq
		0	1	0	0	5	4	1	2	5	E	D	B	2	0	A	0	A	0	3	3	1	1	1	0	8mmAq
		0	1	0	0	5	4	1	2	5	E	A	A	2	0	A	0	A	0	3	3	1	1	1	0	6mmAq
		0	1	0	0	5	4	1	2	5	E	7	9	2	0	A	0	A	0	3	3	1	1	1	0	4mmAq
GD-S(Big Duct)	AM180JNHPKH/TK	0	1	2	0	7	4	1	C	5	0	8	0	2	0	B	4	B	4	3	3	1	1	1	0	5 ≤ SP < 7.5
		0	1	2	0	7	4	1	C	5	0	A	1	2	0	B	4	B	4	3	3	1	1	1	0	7.5 ≤ SP < 10
		0	1	2	0	7	4	1	C	5	0	D	3	2	0	B	4	B	4	3	3	1	1	1	0	10 ≤ SP < 12.5
		0	1	2	0	7	4	1	C	5	0	F	5	2	0	B	4	B	4	3	3	1	1	1	0	12.5 ≤ SP < 15
		0	1	2	0	7	4	1	C	5	4	3	7	2	0	B	4	B	4	3	3	1	1	1	0	15 ≤ SP < 17.5
	AM224JNHPKH/TK	0	1	2	0	7	4	1	C	5	0	C	0	2	0	E	0	E	0	3	3	1	1	1	0	5 ≤ SP < 7.5
		0	1	2	0	7	4	1	C	5	0	E	3	2	0	E	0	E	0	3	3	1	1	1	0	7.5 ≤ SP < 10
		0	1	2	0	7	4	1	C	5	0	F	5	2	0	E	0	E	0	3	3	1	1	1	0	10 ≤ SP < 12.5
		0	1	2	0	7	4	1	C	5	4	3	6	2	0	E	0	E	0	3	3	1	1	1	0	12.5 ≤ SP < 15
		0	1	2	0	7	4	1	C	5	4	5	8	2	0	E	0	E	0	3	3	1	1	1	0	15 ≤ SP < 17.5
CEILING	AM056FNCDEH/TK	0	1	3	0	5	4	1	0	5	0	0	0	2	0	3	8	3	8	3	3	0	0	1	0	
	AM071FNCDEH/TK	0	1	3	0	5	4	1	0	5	0	0	0	2	0	4	7	4	7	3	3	0	0	1	0	
CONSOLE	AM022KNJDEH/TK	0	1	9	0	4	4	1	9	5	0	7	4	2	0	1	6	1	6	3	3	0	0	1	0	
	AM028FNJDEH/TK	0	1	9	0	4	4	1	9	5	0	B	7	2	0	1	C	1	C	3	3	0	0	1	0	
	AM036FNJDEH/TK	0	1	9	0	4	4	1	9	5	0	D	7	2	0	2	4	2	4	3	3	0	0	1	0	
	AM045KNJDEH/TK	0	1	9	0	4	4	1	9	5	0	F	9	2	0	2	D	2	D	3	3	0	0	1	0	
	AM056FNJDEH/TK	0	1	9	0	4	4	1	9	5	4	1	B	2	0	3	8	3	8	3	3	0	0	1	0	
NEO-FORTE without EEV	AM022FNTDEH/TK	0	1	0	0	4	4	1	1	7	0	F	A	2	0	1	6	1	6	3	3	0	0	0	0	
	AM028FNTDEH/TK	0	1	0	0	4	4	1	1	7	0	F	A	2	0	1	C	1	C	3	3	0	0	0	0	
	AM036FNTDEH/TK	0	1	0	0	4	4	1	1	7	4	4	D	2	0	2	4	2	4	3	3	0	0	0	0	
	AM056FNTDEH/TK	0	1	0	0	4	4	1	1	6	4	6	F	2	0	3	8	3	8	3	3	0	0	2	0	
	AM071FNTDEH/TK	0	1	0	0	4	4	1	1	6	4	8	F	2	0	4	7	4	7	3	3	0	0	2	0	

Item	Model	SEG																								Static Pressure
		1	2	3	4	5	6	7	8	9	10	11	12	13	14	15	16	17	18	19	20	21	22	23	24	
NEO-FORTE with EEV	AM022FNQDEH/TK	0	1	0	0	4	4	1	1	7	0	F	A	2	0	1	6	1	6	3	1	0	0	0	0	
	AM028FNQDEH/TK	0	1	0	0	4	4	1	1	7	0	F	A	2	0	1	C	1	C	3	1	0	0	0	0	
	AM036FNQDEH/TK	0	1	0	0	4	4	1	1	7	4	4	D	2	0	2	4	2	4	3	1	0	0	0	0	
	AM045FNQDEH/TK	0	1	0	0	4	4	1	1	6	4	3	F	2	0	2	D	2	D	3	1	0	0	2	0	
	AM056FNQDEH/TK	0	1	0	0	4	4	1	1	6	4	6	F	2	0	3	8	3	8	3	1	0	0	2	0	
A3050 (EEV INCLUDED)	AM015JNVDKH/TK	0	1	2	0	4	4	1	9	9	0	D	9	2	0	0	F	0	F	3	1	0	0	0	0	
	AM022JNVDKH/TK	0	1	2	0	4	4	1	9	9	4	2	A	2	0	1	6	1	6	3	1	0	0	0	0	
	AM028JNVDKH/TK	0	1	2	0	4	4	1	9	9	4	5	C	2	0	1	C	1	C	3	1	0	0	0	0	
	AM036JNVDKH/TK	0	1	2	0	4	4	1	9	8	4	5	E	2	0	2	4	2	4	3	1	0	0	1	0	
	AM045JNVDKH/TK	0	1	2	0	4	4	1	9	5	5	A	2	2	0	2	D	2	D	3	1	0	0	1	0	
	AM056JNVDKH/TK	0	1	2	0	4	4	1	9	9	4	2	C	2	0	3	8	3	8	3	1	0	0	2	0	
	AM071JNVDKH/TK	0	1	2	0	4	4	1	9	8	4	7	F	2	0	4	7	4	7	3	1	0	0	2	0	
AM082JNVDKH/TK	0	1	2	0	4	4	1	9	5	5	A	3	2	0	5	2	5	2	3	1	0	0	2	0		
360 cassette	AM045KN4DEH*	0	1	0	0	4	F	1	9	5	0	B	7	2	0	2	D	2	D	3	3	0	0	0	0	-
	AM056KN4DEH*	0	1	0	0	4	F	1	9	5	0	C	7	2	0	3	8	3	8	3	3	0	0	0	0	-
	AM071KN4DEH*	0	1	0	0	4	F	1	9	5	0	D	8	2	0	4	7	4	7	3	3	0	0	0	0	-
	AM090KN4DEH*	0	1	0	0	4	F	1	9	5	4	1	A	2	0	5	A	5	A	3	3	0	0	0	0	-
	AM112KN4DEH*	0	1	0	0	4	F	1	9	5	4	2	B	2	0	7	0	7	0	3	3	0	0	2	0	-
	AM128KN4DEH*	0	1	0	0	4	F	1	9	5	4	6	C	2	0	8	0	8	0	3	3	0	0	2	0	-
AM140KN4DEH*	0	1	0	0	4	F	1	9	5	4	8	E	2	0	8	C	8	C	3	3	0	0	2	0	-	

* If you are going to use up to SEG 24, please refer to following instruction.

SEG 17 : 0 → 1: Using high ceiling kit for 4way

SEG 18 :

	Not in use	Use
Change temperature display	0(Celsius)	1(Fahrenheit)
Sound Mute	0	2
Mixed operation control	0	4

- If you want to use multiple functions, add each of the 'use' value of the function you want to used and input the final addition as option value. (Use Fahrenheit + Sound mute + Mixed operation control : 1 + 2 + 4 = 7)

Ex) 044217-1d00e6-200000-300000

When using Sound mute : 044217-1d00e6-200002-300000

When using high ceiling kit for 4way and mixed operation error preventing function : 044217-1d00e6-200014-300000

4-3-3 What to check before diagnosis















4-3-3-1 Lamp combination expression method display (cassette type indoor unit)

- Slim 1-Way, 2 -Way, Mini 4-Way cassette type

■ Error detection and restart

- When error occurs during operation, indicate a problem with LED flashes, and no other operations but LED stops.
- When restarting operation with remote controller or switch, it will determine the appropriate error mode after normal operation

■ LED lamp display with error detection

Abnormal condition	Error code	LED Display				
						
		Green	Red			
Error on indoor temperature sensor (Short or Open)	E121	×	×		×	×
1. Error on Eva-in sensor (Short or Open) 2. Error on Eva-out sensor (Short or Open) 3. Discharge sensor error (Short or Open)	E122 E123 E126		×		×	×
Indoor fan error	E154	×	×	×		×
1. Error on outdoor temperature sensor (Short or Open) 2. Error on cond sensor 3. Error on discharge sensor Other outdoor unit sensor error that is not on the above list	E221 E237 E251		×	×		×
1. When there is no communication between the indoor-outdoor units for 2 minutes 2. Communication error received from the outdoor unit 3. 3 minute tracking error on outdoor unit 4. Communication error after tracking due to unmatching number of installed units 5. Error due to repeated communication address 6. Communication address not confirmed Other outdoor unit communication error that is not on the above list	E101 E102 E202 E201 E108 E109	×	×			×
Self diagnosis error display 1. Error due to opened EEV (2nd detection) 2. Error due to closed EEV (2nd detection) 3. Eva in sensor is detached 4. Eva out sensor is detached 5. Thermal fuse error (Open)	E151 E152 E128 E129 E198	×	×			

● : On  : Flickering × : Off

- If you turn off the air conditioner when the LED is flickering, the LED is also turned off.
- If you re-operate the air conditioner, it operates normally at first, then detect an error again.
- When E108 error occurs, change the address and reset the system.
- Ex.) When address of the indoor unit #1 and #2 are set as 5, address of the indoor unit #1 will become 5 and indoor unit #2 will display E108, A002.

■ LED lamp display with error detection (cont.)

Abnormal condition	Error code	LED Display				
		Green	Red			
1. COND mid sensor is detached	E241					
2. Refrigerant leakage (2nd detection)	E554					
3. Abnormally high temperature on Cond (2nd detection)	E450					
4. Low pressure s/w (2nd detection)	E451					
5. Abnormally high temperature on discharged air on outdoor unit (2nd detection)	E416					
6. Indoor operation stop due to unconfirmed error on outdoor unit	E559					
7. Error due to reverse phase detection	E425					
8. Comp stop due to freeze detection (6th detection)	E403					
9. High pressure sensor is detached	E301	×	×	◐	◐	◐
10. Low pressure sensor is detached	E306					
11. Outdoor unit copression ration error	E428					
12. Outdoor sump down_1 prevetion control	E413					
13. Compressor down due to low pressure sensor prevention control_1	E410					
14. Simultaneous opening of cooling/heating MCU SOL valve (1st detection)	E180					
15. Simultaneous opening of cooling/heating MCU SOL valve (2nd detection)	E181					
Other outdoor unit self-diagnosis error that is not on the above list						
Flowating s/w (2nd detection)	E153	×	×	×	◐	◐
EEPROM error	E162	◐	◐	◐	◐	◐
EEPROM option error	E163	◐	◐	◐	◐	◐
Error due to incompatible indoor unit	E164	×	×	×	×	◐

● : On ◐ : Flickering × : Off





- If you turn off the air conditioner when the LED is flickering, the LED is also turned off.
 - If you re-operate the air conditioner, it operates normally at first, then detect an error again.
 - When E108 error occurs, change the address and reset the system.
- Ex.) When address of the indoor unit #1 and #2 are set as 5, address of the indoor unit #1 will become 5 and indoor unit #2 will display E108, A002.

- Global 4way cassette type











■ Error detection and restart

- When error occurs during operation, indicate a problem with LED flashes, and no other operations but LED stops.
- When restarting operation with remote controller or switch, it will determine the appropriate error mode after normal operation

■ LED lamp display with error detection

Abnormal condition	Error code	LED Display			
		Operation	Defrost	Timer	Filter
					
Error on indoor temperature sensor (Short or Open)	E121	×	◐	×	×
1. Error on Eva-in sensor (Short or Open) 2. Error on Eva-out sensor (Short or Open) 3. Discharge sensor error (Short or Open)	E122 E123 E126	◐	◐	×	×
Indoor fan error	E154	×	×	◐	×
1. Error on outdoor temperature sensor (Short or Open) 2. Error on cond sensor 3. Error on discharge sensor Other outdoor unit sensor error that is not on the above list	E221 E237 E251	◐	×	◐	×
1. When there is no communication between the indoor-outdoor units for 2 minutes 2. Communication error received from the outdoor unit 3. 3 minute tracking error on outdoor unit 4. Communication error after tracking due to unmatching number of installed units 5. Error due to repeated communication address 6. Communication address not confirmed Other outdoor unit communication error that is not on the above list	E101 E102 E202 E201 E108 E109	×	◐	◐	×
Self diagnosis error display 1. Error due to opened EEV (2nd detection) 2. Error due to closed EEV (2nd detection) 3. Eva in sensor is detached 4. Eva out sensor is detached 5. Thermal fuse error (Open)	E151 E152 E128 E129 E198	×	◐	◐	◐
1. COND mid sensor is detached. 2. Refrigerant leakage (2nd detection). 3. Abnormally high temperature on Cond. (2nd detection) 4. Low pressure s/w. (2nd detection) 5. Abnormally high temperature on discharged air on outdoor unit. (2nd detection) 6. Indoor operation stop due to unconfirmed error on outdoor unit. 7. Error due to reverse phase detection. 8. Comp stop due to freeze detection. (6th detection) 9. High pressure sensor is detached. 10. Low pressure sensor is detached. 11. Outdoor unit copression ration error 12. Outdoor sump down_1 prevetion control 13. Compressor down due to low pressure sensor prevention control_1 14. Simultaneous opening of cooling/heating MCU SOL valve (1st detection) 15. Simultaneous opening of cooling/heating MCU SOL valve (2nd detection) Other outdoor unit self-diagnosis error that is not on the above list	E241 E554 E450 E451 E416 E559 E425 E403 E301 E306 E428 E413 E410 E180 E181	×	◐	◐	◐
Flowating s/w (2nd detection)	E153	×	×	◐	◐
EEPROM error	E162	◐	◐	◐	◐

■ LED lamp display with error detection (cont.)

Abnormal condition	Error code	LED Display			
		Operation	Defrost	Timer	Filter
					
EEPROM option error	E163				
Error due to incompatible indoor unit	E164			×	

● : On ◐ : Flickering × : Off

- If you turn off the air conditioner when the LED is flickering, the LED is also turned off.
 - If you re-operate the air conditioner, it operates normally at first, then detect an error again.
 - When E108 error occurs, change the address and reset the system.
- Ex.) When address of the indoor unit #1 and #2 are set as 5, address of the indoor unit #1 will become 5 and indoor unit #2 will display E108, A002.

- 360 Cassett

Condition of the indoor unit	Error code	Indoor unit display indications			
		Ice blue	Yellow green	Blue	Red
Power reset (blinking once every 2 seconds)	NO ERROR	●	X	X	X
In the defrost operation (blinking once every 10 seconds)	NO ERROR	●	X	X	X
Open or short circuit error of the indoor-temperature sensor	E121	X	X	X	●
Open or short circuit error of the evaporator-in sensor	E122	X	●	X	●
Open or short circuit error of the evaporator-out sensor	E123	X	X	●	●
Error of the fan in the indoor unit	E154				
1. Open or short circuit error of the outdoor-temperature sensor	E221				
2. Open or short circuit error of the condenser sensor	E237				
3. Open or short circuit error of the discharge sensor	E251				
Errors of the sensors of the outdoor unit other than the errors listed above					
1. Error due to the opened EEV (2nd detection)	E151				
2. Error due to the closed EEV (2nd detection)	E152				
3. The evaporator-in sensor is detached.	E128				
4. The evaporator-out sensor is detached.	E129				
5. The condenser mid sensor is detached.	E241	X	X	●	X
6. Refrigerant leakage (2nd detection)	E554				
7. Abnormal high temperature on the condenser (2nd detection)	E554				
8. Low pressure switch (2nd detection)	E451				
9. Abnormal high temperature on the air discharged from the outdoor unit (2nd detection)	E416				
10. The indoor unit stops due to an unknown error of the outdoor unit.	E559				
11. Error of detection of a reverse phase	E425				
12. The compressor stops due to freeze detection (6th detection)	E403				
13. The high pressure sensor is detached.	E301				
14. The low pressure sensor is detached.	E306				
15. Compression ratio error of the outdoor unit	E428				
16. Outdoor sump down_1 prevention control	E413				
17. Compressor shutdown due to the low-pressure-sensor prevention control_1	E410				
18. Simultaneous opening of the cooling and heating MCU SOL valves (1st detection)	E180	X	X	●	X
19. Simultaneous opening of the cooling and heating MCU SOL valves (2nd detection)	E181				
Self-diagnosis errors other than the errors listed above					

Condition of the indoor unit	Error code	Indoor unit display indications			
		Ice blue	Yellow green	Blue	Red
No communication occurs between the indoor and outdoor units for 2 minutes.	E101				
Communication error received from the outdoor unit	E102				
Error of 3 minute tracking on the outdoor unit	E202				
The number of the installed indoor units that is transmitted via communication after the tracking is different.	E201	X	●	X	X
Error of duplicated communication addresses (NASA only)	E108				
The communication address is not confirmed. (NASA only)	E109				
Communication errors other than the errors listed above					
Error of the second detection of the float switch	E153	X	●	●	X
EEPROM error	E162	●	●	X	●
EEPROM option error	E163				
Error of incompatibility of the indoor unit	E164	●	X	X	●
Error of mixed operation	E161	●	●	X	X
Open circuit error of the thermal fuse	E198	●	X	●	X

● : On, ● : Blinking, X : Off



Ice blue	Yellow green
Blue	Red

- Duct type

■ Error detection and restart

- When error occurs during operation, indicate a problem with LED flashes, and no other operations but LED stops.
- When restarting operation with remote controller or switch, it will determine the appropriate error mode after normal operation





■ LED lamp display with error detection(Remote Control Receiver)

Abnormal condition	Error code	LED Display				
Error on indoor temperature sensor (Short or Open)	E121	×	×	◐	×	×
1. Error on Eva-in sensor (Short or Open) 2. Error on Eva-out sensor (Short or Open) 3. Discharge sensor error (Short or Open)	E122 E123 E126	◐	×	◐	×	×
Indoor fan error	E154	×	×	×	◐	×
1. Error on outdoor temperature sensor (Short or Open) 2. Error on cond sensor 3. Error on discharge sensor Other outdoor unit sensor error that is not on the above list	E221 E237 E251	◐	×	×	◐	×
1. When there is no communication between the indoor-outdoor units for 2 minutes 2. Communication error received from the outdoor unit 3. 3 minute tracking error on outdoor unit 4. Communication error after tracking due to unmatching number of installed units 5. Error due to repeated communication address 6. Communication address not confirmed Other outdoor unit communication error that is not on the above list	E101 E102 E202 E201 E108 E109	×	×	◐	◐	×
Self diagnosis error display 1. Error due to opened EEV (2nd detection) 2. Error due to closed EEV (2nd detection) 3. Eva in sensor is detached 4. Eva out sensor is detached 5. Thermal fuse error (Open)	E151 E152 E128 E129 E198	×	×	◐	◐	◐

● : On ◐ : Flickering × : Off

- If you turn off the air conditioner when the LED is flickering, the LED is also turned off.
- If you re-operate the air conditioner, it operates normally at first, then detect an error again.
- When E108 error occurs, change the address and reset the system.Ex.) When address of the indoor unit #1 and #2 are set as 5, address of the indoor unit #1 will become 5 and indoor unit #2 will display E108, A002.

■ LED lamp display with error detection(Remote Control Receiver) (cont.)

Abnormal condition	Error code	LED Display				
						
1. COND mid sensor is detached 2. Refrigerant leakage (2nd detection) 3. Abnormally high temperature on Cond (2nd detection) 4. Low pressure s/w (2nd detection) 5. Abnormally high temperature on discharged air on outdoor unit (2nd detection) 6. Indoor operation stop due to unconfirmed error on outdoor unit 7. Error due to reverse phase detection 8. Comp stop due to freeze detection (6th detection) 9. High pressure sensor is detached 10. Low pressure sensor is detached 11. Outdoor unit compression ration error 12. Outdoor sump down_1 prevention control 13. Compressor down due to low pressure sensor prevention control_1 14. Simultaneous opening of cooling/heating MCU SOL valve (1st detection) 15. Simultaneous opening of cooling/heating MCU SOL valve (2nd detection) Other outdoor unit self-diagnosis error that is not on the above list	E241 E554 E450 E451 E416 E559 E425 E403 E301 E306 E428 E413 E410 E180 E181					
Flowating s/w (2nd detection)	E153	×	×	×	●	●
EEPROM error	E162	●	●	●	●	●
EEPROM option error	E163	●	●	●	●	●
Error due to incompatible indoor unit	E164	×	×	×	×	●

● : On ● : Flickering × : Off

- If you turn off the air conditioner when the LED is flickering, the LED is also turned off.
- If you re-operate the air conditioner, it operates normally at first, then detect an error again.
- When E108 error occurs, change the address and reset the system.Ex.) When address of the indoor unit #1 and #2 are set as 5, address of the indoor unit #1 will become 5 and indoor unit #2 will display E108, A002.

- Ceiling type

■ Error detection and reoperation

- If an error occurs during the operation, an LED flickers and the operation is stopped except the LED.
- If you re-operate the air conditioner, it operates normally at first, then detect an error again.

■ Indoor unit LED lamp display at error detecting

Abnormal condition	Error code	LED Display				
Error on indoor temperature sensor (Short or Open)	E121	×	×	◐	×	×
1. Error on Eva-in sensor (Short or Open) 2. Error on Eva-out sensor (Short or Open)	E122 E123	◐	×	◐	×	×
Indoor fan error	E154	×	×	×	◐	×
1. Error on outdoor temperature sensor (Short or Open) 2. Error on cond sensor 3. Error on discharge sensor	E221 E237 E251	◐	×	×	◐	×
1. When there is no communication between the indoor-outdoor units for 2 minutes 2. Communication error received from the outdoor unit 3. 3 minute tracking error on outdoor unit 4. Communication error after tracking due to unmatching number of installed units 5. Error due to repeated communication address	E101 E102 E202 E201 E108	×	×	◐	◐	×
Self diagnosis error display 1. Error due to opened EEV (2nd detection) 2. Error due to closed EEV (2nd detection) 3. Eva in sensor is detached 4. Eva out sensor is detached 5. Thermal fuse error (Open)	E151 E152 E128 E128 E198	×	×	◐	◐	◐
1. COND mid sensor is detached 2. Refrigerant leakage (2nd detection) 3. Abnormally high temperature on Cond (2nd detection) 4. Low pressure s/w. (2nd detection) 5. Abnormally high temperature on discharged air on outdoor unit. (2nd detection) 6. Indoor operation stop due to unconfirmed error on outdoor unit 7. Error due to reverse phase detection 8. Comp stop due to freeze detection (6th detection) 9. High pressure sensor is detached 10. Low pressure sensor is detached 11. Outdoor unit copression ration error 12. Outdoor sump down_1 prevetion control 13. Compressor down due to low pressure sensor prevention control_1 14. Simultaneous opening of cooling/heating MCU SOL valve (1st detection) 15. Simultaneous opening of cooling/heating MCU SOL valve (2nd detection)	E241 E554 E450 E451 E416 E559 E425 E403 E301 E306 E428 E413 E410 E180 E181	×	×	◐	◐	◐
Flowating s/w (2nd detection)	E153	×	×	×	◐	◐
EEPROM option error	E162	◐	◐	◐	◐	◐
EEPROM option error	E163	◐	◐	◐	◐	◐
Error due to incompatible indoor unit	E164	×	×	×	×	◐

● : On ◐ : Flickering × : Off

- If you turn off the air conditioner when the LED is flickering, the LED is also turned off.
- If you re-operate the air conditioner, it operates normally at first, then detect an error again.

- Console type

■ Error detection and reoperation

- If an error occurs during the operation, an LED flickers and the operation is stopped except the LED.
- If you re-operate the air conditioner, it operates normally at first, then detect an error again.

■ Indoor unit LED lamp display at error detecting

Abnormal condition	Error code	LED Display				
Error on indoor temperature sensor (Short or Open)	E121	×	×	●	×	×
1. Error on Eva-in sensor (Short or Open) 2. Error on Eva-out sensor (Short or Open)	E122 E123	●	×	●	×	×
Indoor fan error	E154	×	×	×	●	×
1. Error on outdoor temperature sensor (Short or Open) 2. Error on cond sensor 3. Error on discharge sensor	E221 E237 E251	●	×	×	●	×
1. When there is no communication between the indoor-outdoor units for 2 minutes 2. Communication error received from the outdoor unit 3. 3 minute tracking error on outdoor unit 4. Communication error after tracking due to unmatching number of installed units 5. Error due to repeated communication address	E101 E102 E202 E201 E108	×	×	●	●	×
Self diagnosis error display 1. Error due to opened EEV (2nd detection) 2. Error due to closed EEV (2nd detection) 3. Eva in sensor is detached 4. Eva out sensor is detached 5. Thermal fuse error (Open)	E151 E152 E128 E128 E198	×	×	●	●	×
1. COND mid sensor is detached 2. Refrigerant leakage (2nd detection) 3. Abnormally high temperature on Cond (2nd detection) 4. Low pressure s/w (2nd detection) 5. Abnormally high temperature on discharged air on outdoor unit. (2nd detection) 6. Indoor operation stop due to unconfirmed error on outdoor unit 7. Error due to reverse phase detection 8. Comp stop due to freeze detection (6th detection) 9. High pressure sensor is detached 10. Low pressure sensor is detached 11. Outdoor unit copression ration error 12. Outdoor sump down_1 prevetion control 13. Compressor down due to low pressure sensor prevention control_1 14. Simultaneous opening of cooling/heating MCU SOL valve (1st detection) 15. Simultaneous opening of cooling/heating MCU SOL valve (2nd detection)	E241 E554 E450 E451 E416 E559 E425 E403 E301 E306 E428 E413 E410 E180 E181	×	×	●	●	●
Flowating s/w (2nd detection)	E153	×	×	×	●	●
EEPROM error	E162	●	●	●	●	●
EEPROM option error	E163	●	●	●	●	●
Error due to incompatible indoor unit	E164	×	×	×	×	●

● : On ● : Flickering × : Off

- If you turn off the air conditioner when the LED is flickering, the LED is also turned off.

- Wall-mounted type (Neo Forte without EEV/with EEV)

■ Error detection and reoperation

- If an error occurs during the operation, an LED flickers and the operation is stopped except the LED.
- If you re-operate the air conditioner, it operates normally at first, then detect an error again.

■ Indoor unit LED lamp display at error detecting

Abnormal condition	Error code	LED Display		
Error on indoor temperature sensor (Short or Open)	E121	×	●	×
1. Error on Eva-in sensor (Short or Open) 2. Error on Eva-out sensor (Short or Open)	E122 E123	●	●	×
Indoor fan error	E154	×	×	●
1. Error on outdoor temperature sensor (Short or Open) 2. Error on cond sensor 3. Error on discharge sensor	E221 E237 E251	●	×	●
1. When there is no communication between the indoor-outdoor units for 2 minutes 2. Communication error received from the outdoor unit 3. 3 minute tracking error on outdoor unit 4. Communication error after tracking due to unmatching number of installed units 5. Error due to repeated communication address	E101 E102 E202 E201 E108	×	●	●
Self diagnosis error display 1. Error due to opened EEV (2nd detection) 2. Error due to closed EEV (2nd detection) 3. Eva in sensor is detached 4. Eva out sensor is detached 5. Thermal fuse error (Open)	E151 E152 E128 E128 E198	●	●	●
1. COND mid sensor is detached 2. Refrigerant leakage (2nd detection) 3. Abnormally high temperature on Cond (2nd detection) 4. Low pressure s/w (2nd detection) 5. Abnormally high temperature on discharged air on outdoor unit (2nd detection) 6. Indoor operation stop due to unconfirmed error on outdoor unit 7. Error due to reverse phase detection 8. Comp stop due to freeze detection (6th detection) 9. High pressure sensor is detached 10. Low pressure sensor is detached 11. Outdoor unit copression ration error 12. Outdoor sump down_1 prevetion control 13. Compressor down due to low pressure sensor prevention control_1 14. Simultaneous opening of cooling/heating MCU SOL valve (1st detection) 15. Simultaneous opening of cooling/heating MCU SOL valve (2nd detection)	E241 E554 E450 E451 E416 E559 E425 E403 E301 E306 E428 E413 E410 E180 E181	●	●	●
EEPROM error	E162	●	●	●
EEPROM option error	E163	●	●	●
Error due to incompatible indoor unit	E164	●	●	●

● : On ● : Flickering × : Off

- If you turn off the air conditioner when the LED is flickering, the LED is also turned off.

- Floor Standing type

■ Error detection and reoperation

- If an error occurs during the operation, an LED flickers and the operation is stopped except the LED.
- If you re-operate the air conditioner, it operates normally at first, then detect an error again.

■ Indoor unit LED lamp display at error detecting

Abnormal condition	Error code	LED Display				
Error on indoor temperature sensor (Short or Open)	E121	×	×	◐	×	×
1. Error on Eva-in sensor (Short or Open) 2. Error on Eva-out sensor (Short or Open)	E122 E123	◐	×	◐	×	×
Indoor fan error	E154	×	×	×	◐	×
1. Error on outdoor temperature sensor (Short or Open) 2. Error on cond sensor 3. Error on discharge sensor Other outdoor unit sensor error that is not on the above list	E221 E237 E251	◐	×	×	◐	×
1. When there is no communication between the indoor-outdoor units for 2 minutes 2. Communication error received from the outdoor unit 3. 3 minute tracking error on outdoor unit 4. Communication error after tracking due to unmatching number of installed units 5. Error due to repeated communication address 6. Communication address not confirmed Other outdoor unit communication error that is not on the above list	E101 E102 E202 E201 E108 E109	×	×	◐	◐	×
Self diagnosis error display 1. Error due to opened EEV (2nd detection) 2. Error due to closed EEV (2nd detection) 3. Eva in sensor is detached 4. Eva out sensor is detached 5. Thermal fuse error (Open)	E151 E152 E128 E129 E198	×	×	◐	◐	×

● : On ◐ : Flickering × : Off

- If you turn off the air conditioner when the LED is flickering, the LED is also turned off.
- If you re-operate the air conditioner, it operates normally at first, then detect an error again.
- When E108 error occurs, change the address and reset the system.

Ex.) When address of the indoor unit #1 and #2 are set as 5, address of the indoor unit #1 will become 5 and indoor unit #2 will display E108, A002.

■ Indoor unit LED lamp display at error detecting (cont.)

Abnormal condition	Error code	LED Display				
1. COND mid sensor is detached	E241					
2. Refrigerant leakage (2nd detection)	E554					
3. Abnormally high temperature on Cond (2nd detection)	E450					
4. Low pressure s/w (2nd detection)	E451					
5. Abnormally high temperature on discharged air on outdoor unit (2nd detection)	E416					
6. Indoor operation stop due to unconfirmed error on outdoor unit	E559					
7. Error due to reverse phase detection	E425					
8. Comp stop due to freeze detection (6th detection)	E403	×	×	◐	◐	◐
9. High pressure sensor is detached	E301	×	×	◐	◐	◐
10. Low pressure sensor is detached	E306					
11. Outdoor unit copression ration error	E428					
12. Outdoor sump down_1 prevetion control	E413					
13. Compressor down due to low pressure sensor prevention control_1	E410					
14. Simultaneous opening of cooling/heating MCU SOL valve (1st detection)	E180					
15. Simultaneous opening of cooling/heating MCU SOL valve (2nd detection)	E181					
Other outdoor unit self-diagnosis error that is not on the above list						
Flowating s/w (2nd detection)	E153	×	×	×	◐	◐
EEPROM error	E162	◐	◐	◐	◐	◐
EEPROM option error	E163	◐	◐	◐	◐	◐
Error due to incompatible indoor unit	E164	×	×	×	×	◐

● : On ◐ : Flickering × : Off

- If you turn off the air conditioner when the LED is flickering, the LED is also turned off.
- If you re-operate the air conditioner, it operates normally at first, then detect an error again.
- When E108 error occurs, change the address and reset the system.

Ex.) When address of the indoor unit #1 and #2 are set as 5, address of the indoor unit #1 will become 5 and indoor unit #2 will display E108, A002.

- ERV Plus type

If an error occurs during the operation, The Wired Remote controller show that Error mode.

- When ERRORS related to cooling and heating operation occur, the ventilator (ERV) continues to perform in normal operation.

- When ERRORS related to a ventilator (ERV) occur, it stops operating.

■ ERROR CODE DISPLAY on Wired remote controller

Error code	Explanation	Classifications	
E101	No communication between indoor unit and outdoor unit	ERRORS RELATED TO COOLING AND HEATING OPERATION	
E102	Indoor unit receiving the communication error from outdoor unit		
E122	EVA-IN Sensor(open/short)		
E123	EVA-OUT Sensor(open/short)		
E128	Breakaway of EVA-IN Sensor		
E129	Breakaway of EVA-OUT Sensor		
E174	EVA-IN Air sensor(open/short)		
E151	Error of EEV open		
E152	Error of EEV close		
E161	Error of mixed operation		
E201	Communication error from outdoor unit due to the mismatching of the communication numbers and installed numbers after tracking		
E121	Indoor Temperature Sensor(open/short)		Errors related to ventilator (ERV) operation
E175	Outdoor Temperature Sensor(open/short)		
E139	CO2 sensor (open/short)		
E162	EEPROM ERROR		
E163	EEPROM option setting error		
E186	SPI Error		
E561	Supply Air Fan Motor error		
E562	Exhaust Air Fan Motor error		
E654	Damper ERROR (When there is no switch input for 100 seconds while monitoring the damper)		

4-3-4 Number Display Method (Outdoor Unit, MCU, Cable remote control, wall-mount, etc.)

■ How to Display Integrated Error Code

► Meanings of First Alphabetical Character / Number of Error Code

Displayed alphabet	Explanation	
<i>E</i>	When displaying Error 101~700	
<i>P</i>	When displaying Error 701~800	
<i>C</i>	When E206 occurs	Displays address of subordinate within the set C001 : HUB, C002: FAN, C003: INV1, C004: INV2
	When MCU error occurs	Displays address of MCU Ex) C100: MCU address 0, C101: MCU address 1, C102: MCU address 2
<i>U</i>	When displaying outdoor unit address Ex) U200: Outdoor unit 1, U201: Outdoor unit 2, U202: Outdoor unit 3, U203: Indoor unit 4	
<i>A</i>	When displaying indoor unit address Ex) A000: Indoor unit adress 0, A001: Indoor unit address 1, A002: Indoor unit address 2	

► Order of Error Display

Classification	Error display method	Display Example
Display method for error that occurred in indoor unit	Error Number → Indoor unit address → Error Number, repeat display	E471 → A002 → E471 → A002
Display method for error that occurred in outdoor unit and other methods of error display	Error Number → Outdoor unit address → Error Number, repeat display	E471 → U200 → E471 → U200 E206 → C001 → E206 → C002

■ Diagnosis and Adjustment (Error Code)

► Error code related indoor unit

CODE	Explanation
E-101	Indoor unit communication error. Indoor unit can not receive any data from outdoor unit.
E-102	Communication error between indoor unit and outdoor unit. Displayed in indoor unit.
E-108	Error due to repeated address setting (When 2 or more devices has same address within the network)
E-121	Error on indoor temperature sensor of indoor unit (Short or Open)
E-122	Error on EVA IN sensor of indoor unit (Short or Open)
E-123	Error on EVA OUT sensor of indoor unit (Short or Open)
E-128	EVA IN temperature sensor of indoor unit is detached from EVA IN pipe
E-129	EVA OUT temperature sensor of indoor unit is detached from EVA OUT pipe
E-130	Heat exchanger in/out sensors of indoor unit are detached
E-135	RPM feedback error of indoor unit's cleaning fan
E-151	Error due to opened EEV of indoor unit (2nd detection)
E-152	Error due to closed EEV of indoor unit (2nd detection)
E-153	Error on floating switch of indoor unit (2nd detection)
E-154	RPM feedback error of indoor unit
E-161	Mixed operation mode error of indoor unit; When outdoor unit is getting ready to operate in cooling (or heating) and some of the indoor unit is trying to operate in heating (or cooling) mode
E-162	EEPROM error of MICOM (Physical problem of parts/circuit)
E-163	Indoor unit's remote controller option input is Incorrect or missing. Outdo or unit EEPROM data error
E-180	Simultaneous opening of cooling/heating MCU SOL V/V (1st detection)
E-181	Simultaneous opening of cooling/heating MCU SOL V/V (2nd detection)
E-185	Cross wiring error between communication and power cable of indoor unit
E-186	Connection error or problem on SPi
E-190	No temperature changes in EVA IN during pipe inspection or changes in temperature is seen in indoor unit with wrong address
E-191	No temperature changes in EVA OUT during pipe inspection or changes in temperature is seen in indoor unit with wrong address
E-198	Error due to disconnected thermal fuse of indoor unit

■ Diagnosis and Adjustment (Error Code)

▶ Error code related to the Communications / Settings / HW (cont.)

CODE	Explanation
E-201	Communication error between indoor and outdoor units (installation number setting error, repeated indoor unit address, indoor unit communication cable error)
E-202	Communication error between indoor and outdoor units (Communication error on all indoor unit, outdoor unit communication cable error)
E-203	Communication error between main and sub outdoor units
E-205	Communication error on all PBA within the outdoor unit C-Box, communication cable error
E-206	E206-C001: HUB PBA communication error / E206-C002: FAN PBA communication error E206-C003: INV1 PBA communication error / E206-C004: INV2 PBA communication error
E-211	When single indoor unit uses 2 MCU ports that are not in series.
E-212	If the rotary switch (on the MCU) for address setting of the indoor unit has 3 or more of the same address
E-213	When total number of indoor units assigned to MCU is same as actual number of installed indoor units but there is indoor unit that is not installed even though it is assigned on MCU
E-214	When number of MCU is not set correctly on the outdoor unit or when two or more MCU was installed some of them have the same address
E-215	When two different MCU's have same address value on the rotary switch
E-216	When indoor unit is not installed to a MCU port but the switch on the port is set to On.
E-217	When indoor unit is connected to a MCU port but indoor unit is assigned to a MCU and the switch on the port is set to Off
E-218	When there's at least one or more actual number of indoor unit connection compared to number of indoor units assigned to MCU
E-219	Error on temperature sensor located on MCU intercooler inlet (Short or Open)
E-220	Error on temperature sensor located on MCU intercooler outlet (Short or Open)
E-221	Error on outdoor temperature sensor of outdoor unit (Short or open)
E-231	Error on COND OUT temperature sensor of main outdoor unit (Short or Open)
E-241	COND OUT sensor is detached
E-251	Error on discharge temperature sensor of compressor 1 (Short or Open)
E-257	Error on discharge temperature sensor of compressor 2 (Short or Open)
E-262	Discharge temperature sensor of compressor 1 is detached from the sensor holder on the pipe
E-263	Discharge temperature sensor of compressor 2 is detached from the sensor holder on the pipe
E-266	Top sensor of compressor 1 is detached
E-267	Top sensor of compressor 2 is detached
E-269	Suction temperature sensor is detached from the sensor holder on the pipe
E-276	Error on top sensor of compressor 1 (Short or Open)
E-277	Error on top sensor of compressor 2 (Short or Open)
E-291	Refrigerant leakage or error on high pressure sensor (Short or Open)
E-296	Refrigerant leakage or error on low pressure sensor (Short or Open)
E-308	Error on suction temperature sensor (Short or Open)

■ Diagnosis and Adjustment (Error Code)

▶ Error code related to the Communications / Settings / HW (cont.)

CODE	Explanation
E-311	Error on temperature sensor of double layer pipe/liquid pipe(sub heat exchanger) (Short or Open)
E-321	Error on EVI (ESC) IN temperature sensor (Short or Open)
E-322	Error on EVI (ESC) OUT temperature sensor (Short or Open)
E-323	Error on suction sensor 2 (Short or Open)
E-346	Error due to operation failure of Fan2
E-347	Motor wire of Fan2 is not connected
E-348	Lock error on Fan2 of outdoor unit
E-353	Error due to overheated motor of outdoor unit's Fan2
E-355	Error due to overheated IPM of Fan2
E-361	Error due to operation failure of inverter compressor 2
E-364	Error due to over-current of inverter compressor 2
E-365	V-limit error of inverter compressor 2
E-366	Error due to over voltage /low voltage of inverter PBA2
E-367	Error due to unconnected wire of compressor 2
E-368	Output current sensor error of inverter PBA2
E-369	DC voltage sensor error of inverter PBA2
E-374	Heat sink temperature sensor error of inverter PBA2
E-378	Error due to overcurrent of Fan2
E-385	Error due to input current of inverter 2
E-386	Over-voltage/low-voltage error of Fan2
E-387	Hall IC connection error of Fan2
E-389	V-limit error on Fan2 of compressor
E-393	Output current sensor error of Fan2
E-396	DC voltage sensor error of Fan2
E-399	Heat sink temperature sensor error of Fan2
E-400	Error due to overheat caused by contact failure on IPM of Inverter PBA2
E-407	Compressor operation stop due to high pressure protection control
E-410	Compressor operation stop due to low pressure protection control or refrigerant leakage
E-416	Compressor operation stop due to discharge temperature protection control
E-425	Phase reversal or phase failure (3Ø outdoor unit wiring, R-S-T-N), connection error on 3 phase input
E-428	Compressor operation stop due abnormal compression ratio
E-438	EVI (ESC) EEV leakage or internal leakage of intercooler or incorrect connector insertion of EVI (ESC) EEV
E-439	Error due to refrigerant leakage
E-440	Heating mode restriction due to high air temperature
E-441	Cooling mode restriction due to low air temperature
E-442	Refrigerant charging restriction in heating mode when air temperature is over 15 °C
E-443	Operation prohibited due to low pressure
E-445	CCH is deatched
E-446	Error due to operation failure of Fan1

■ Diagnosis and Adjustment (Error Code)

▶ Error code related to the Communications / Settings / HW (cont.)

CODE	Explanation
E-447	Motor wire of Fan1 is not connected
E-448	Lock error on Fan1
E-452	Error due to ZPC detection circuit problem or power failure
E-453	Error due to overheated motor of outdoor unit's Fan1
E-455	Error due to overheated IPM of Fan1
E-461	Error due to operation failure of inverter compressor 1
E-462	Compressor stop due to full current control or error due to low current on CT2
E-464	Error due to over-current of inverter compressor 1
E-465	V-limit error of inverter compressor 1
E-466	Error due to over voltage /low voltage of inveter PBA1
E-467	Error due to unconnected wire of compressor 1
E-468	Output current sensor error of inverter PBA1
E-469	DC voltage sensor error of inver PBA1
E-474	Heat sink temperature sensor error of inverter PBA1
E-478	Error due to overcurrent of Fan1
E-485	Error due to input current of inverter 1
E-486	Error due to over voltage/low voltage of Fan
E-487	Hall IC error of Fan1
E-489	V-limit error on Fan1 of compressor
E-493	Output current sensor error of Fan1
E-496	DC voltage sensor error of Fan1
E-499	Heat sink temperature sensor error of Fan1
E-500	Error due to overheat caused by contact failure on IPM of Inverter PBA1
E-503	Error due to alert the user to check if the service valve is closed
E-504	Error due to self diagnosis of compressor operation
E-505	Error due to self diagnosis of high pressure sensor
E-506	Error due to self diagnosis of low pressure sensor
E-560	Outdoor unit's option switch setting error (when inappropriate option switch is on)
E-563	Error due to module installation of indoor unit with old version (Micom version needs to be checked)
E-573	Error due to using single type outdoor unit in a module installation
E-702	Error due to closed EEV of indoor unit (1st detection)
E-703	Error due to opened EEV of indoor unit (1st detection)
UP	Trial operation incompleted (UnPrepared) - It will be cleared when trial operation was executed for 1 hour or when automatic inspection is completed

4-4 Appropriate Measures for Different Symptom

4-4-1 Outdoor Unit Operation Flow

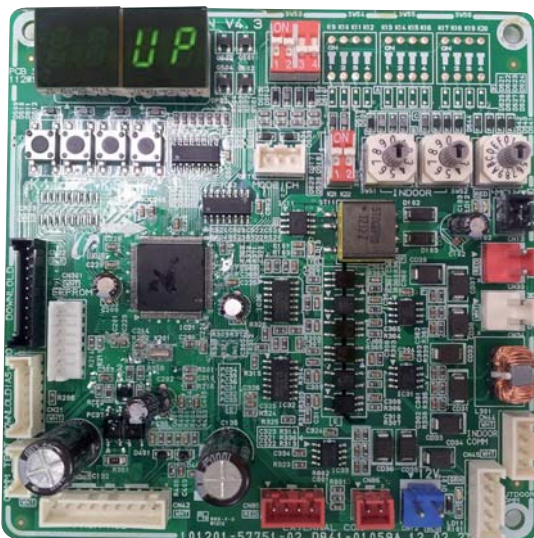
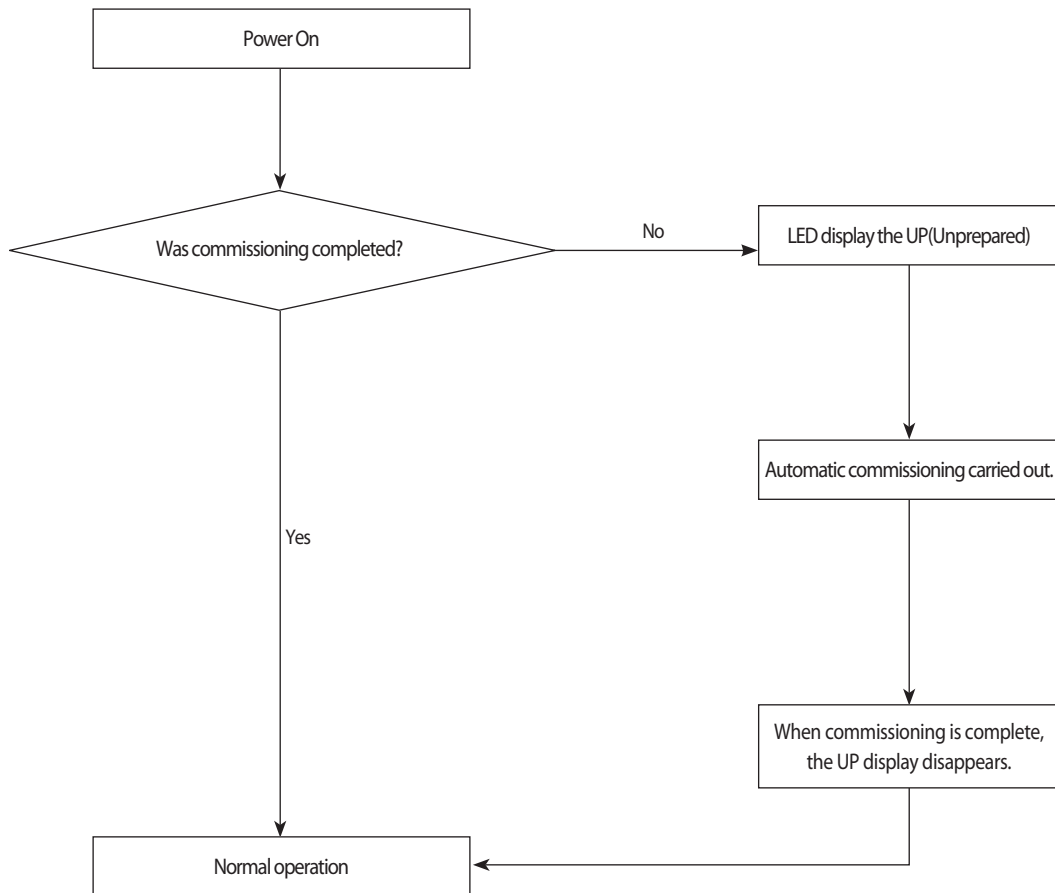

Commissioning if it is not running - UP is displayed

Prior to starting the air conditioning operation after the initial installation and automatic commissioning is carried out. This process, the stable operation to protect the system and verify the defect of the product.

1. Tracking is complete and after the initial installation, if you do not have a history of commissioning is completed, UP will be displayed.
2. Execute the automatic commissioning by Tact Switch.
3. UP display disappears after commissioning is complete, normal operation is possible.
4. Automatic commissioning is completed, if there is a history, normal operation execution immediately.

4-4-2 Main PCB has no power phenomenon

Outdoor unit display	Main PCB has no power phenomenon (7-seg does not blink)
Judgment Method	Hub PCB power and connection wire to detect.
Cause of problem	<ul style="list-style-type: none"> · HUB PCB connector wire defects and the connection is not. · Main PCB defective. · Hub PCB defective. · High pressure switch operation

1. Cause of problem

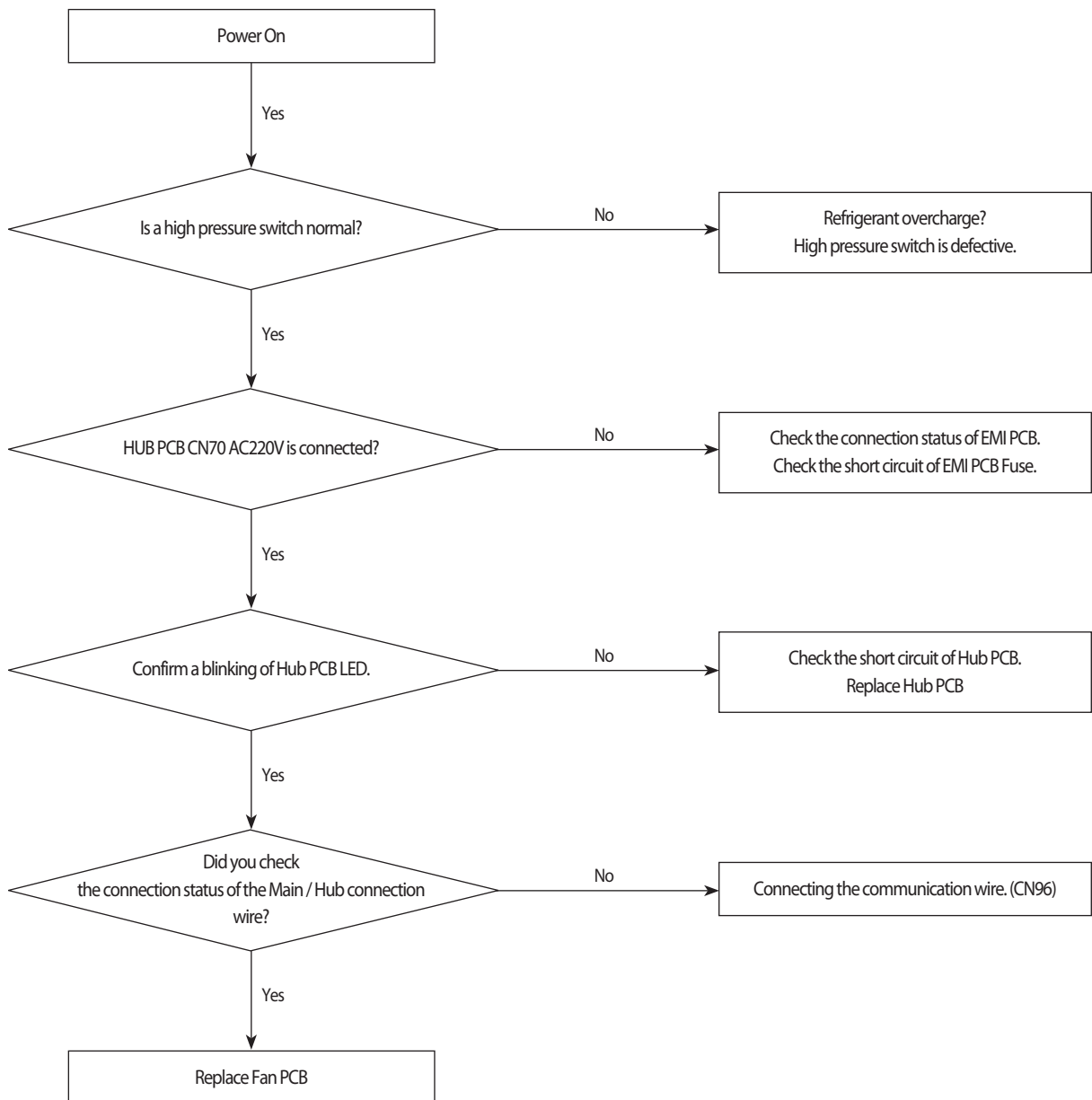

4-4-3 Indoor Unit ROOM sensor Error (Open/Short)

Outdoor unit display	E 121 → A ^{XXX} (XXX: The address of the error occurred indoor unit)
Indoor unit display	×(Operation) ●(Timer) ×(Fan) ×(Filter) ×(Defrost)
Criteria	• Refer to how to determine below
Cause of problem	• The room temperature sensor of No. XXX indoor unit has defective OPEN/SHORT

1. How to check

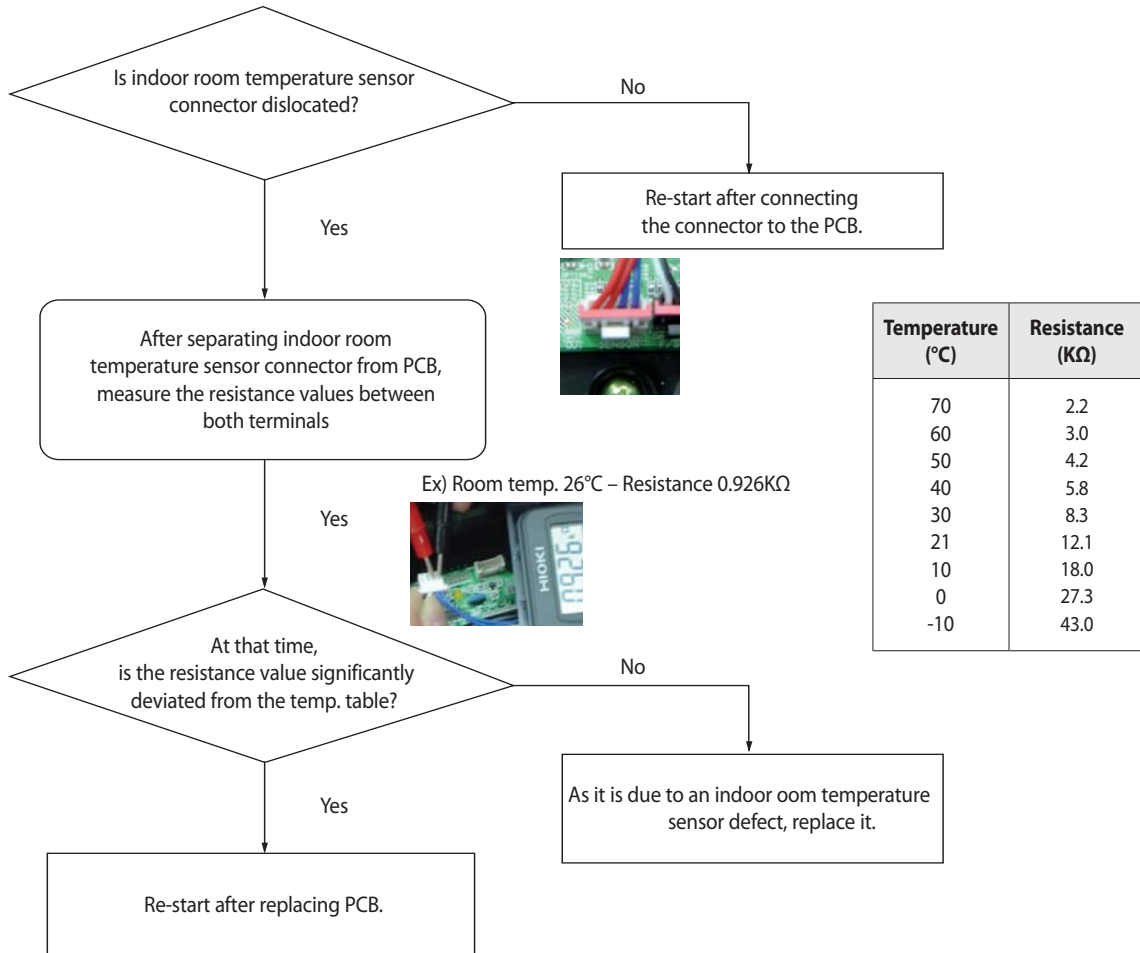

4-4-4 Indoor unit EVAP IN sensor Error (Open/Short)

Outdoor unit display	E 122 ↔ A XXX (XXX: The address of the error occurred indoor unit)
Indoor unit display	● (Operation) ● (Timer) × (Fan) × (Filter) × (Defrost)
Criteria	• Refer to how to determine below
Cause of problem	• The EVAP IN sensor of No. XXX indoor unit has defective OPEN/SHORT

1. How to check

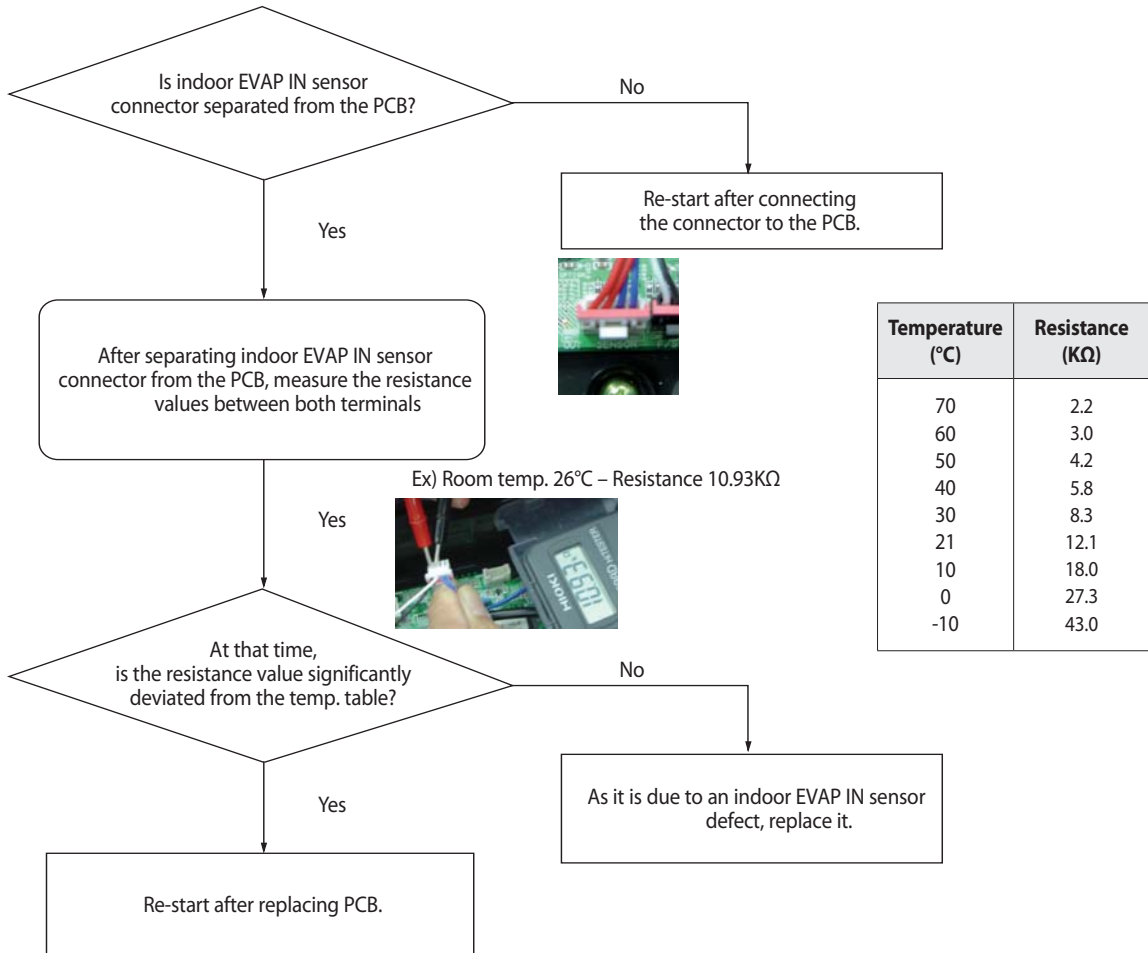

4-4-5 Indoor EVAP OUT sensor Error (Open/Short)

Outdoor unit display	E 123 ← A XXX (XXX: The address of the error occurred indoor unit)
Indoor unit display	●(Operation) ●(Timer) ×(Fan) ×(Filter) ×(Defrost)
Criteria	• Refer to how to determine below
Cause of problem	• The EVAP out sensor of No. XXX indoor unit has defective OPEN/SHORT

1. How to check

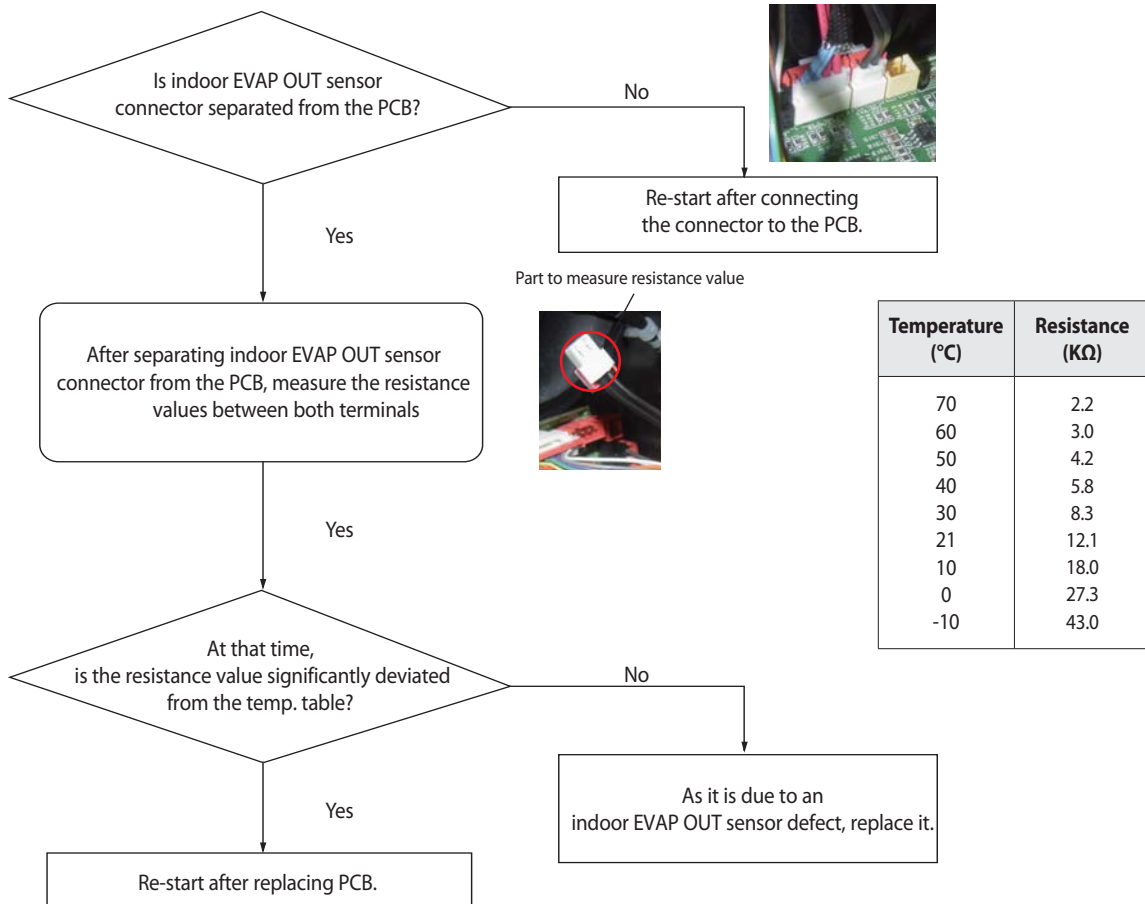

4-4-6 Indoor Heat Exchanger's EVAP IN sensor dislocation error

Outdoor unit display	E 128 ← A ^{x x x} (x x x : The address of the error occurred indoor unit)
Indoor unit display	×(Operation) ●(Timer) ●(Fan) ●(Filter) ×(Defrost)
Criteria	• Refer to how to determine below
Cause of problem	• Indoor heat exchanger's EVAP IN piping sensor has been dislocated

1. How to diagnose

1) During Cooling Operation

Tcond, out - Tair, out > 3°C	OK
Tair, in - Teva, out > 4°C	NO
Tair, in - Teva, out > 4°C	OK
Compressor in operation & Indoor Unit operation & Thermo On	OK
Error details	Breakaway Error of Indoor Heat Exchanger EVA Out sensor

* Hydro Unit : Before and after the Compressor operation, EVA Out temperature difference is less than 3°C.

2) During Heating operation

Average high pressure > 25kg/cm ²	OK
Average low pressure > 8.5kg/cm ²	OK
Tcond, out - Tair, out ≥ 3°C	OK
Tair, in - Teva, out ≥ 2°C	NO
Tcond, out - Tair, out < -2°C	OK
Compressor in operation & Indoor Unit operation & Thermo On	OK
Error details	Breakaway Error of Indoor Heat Exchanger EVA Out sensor

2. How to check

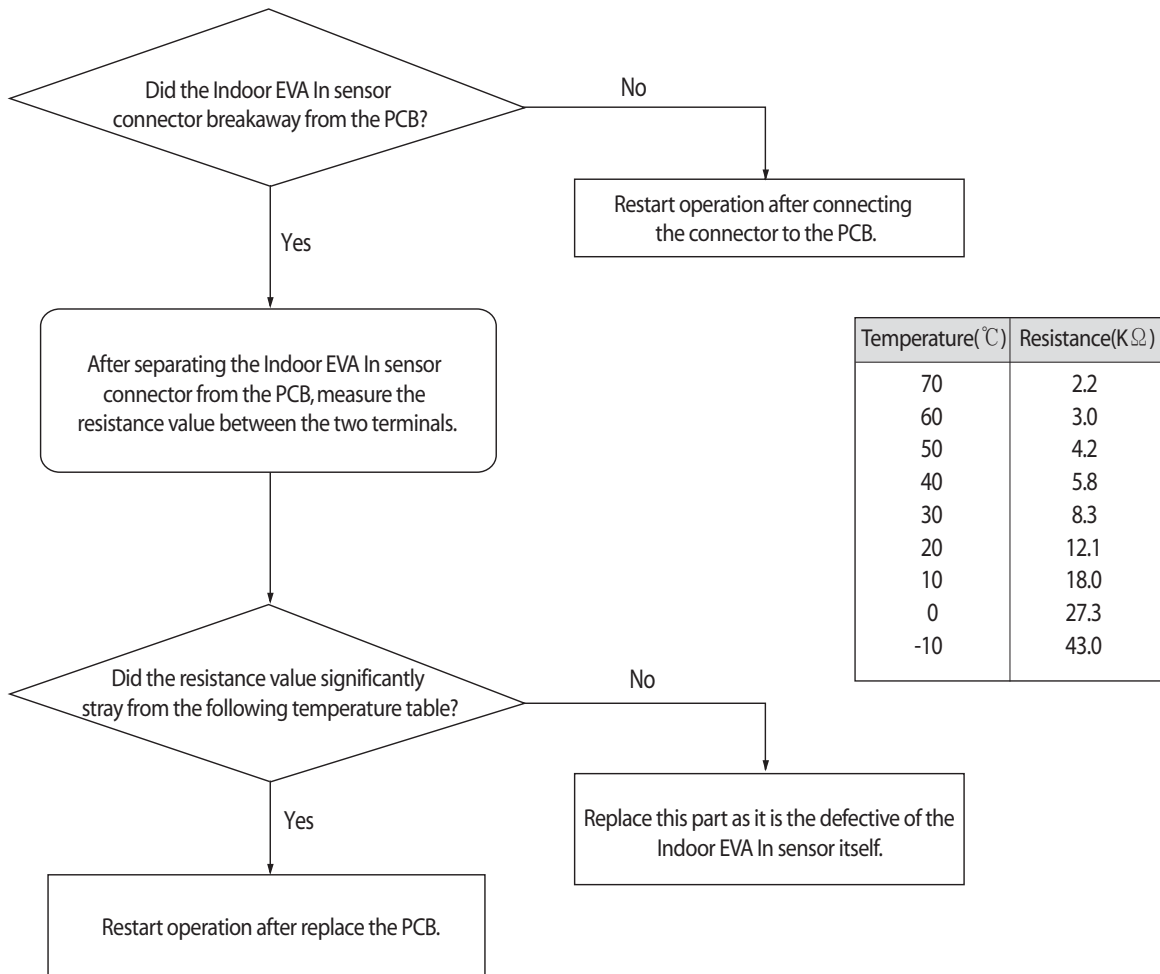

4-4-7 Indoor Heat Exchanger's EVA OUT sensor dislocation error (Open/Short)

Outdoor unit display	E 129 ↔ A ××× (×××: The address of the error occurred indoor unit)
Indoor unit display	×(Operation) ●(Timer) ●(Fan) ●(Filter) ×(Defrost)
Criteria	• Refer to the judgment method below.
Cause of problem	• Breakaway of Indoor Heat Exchanger EVA Out sensor

1. How to diagnose

1) During Cooling Operation

Tcond, out - Tair, out > 3°C	OK
Tair, in - Teva, out > 4°C	NO
Tair, in - Teva, out > 4°C	OK
Compressor in operation & Indoor Unit operation & Thermo On	OK
Error details	Breakaway Error of Indoor Heat Exchanger EVA Out sensor

* Hydro Unit : Before and after the Compressor operation, EVA Out temperature difference is less than 3°C.

2) During Heating operation

Average high pressure > 25kg/cm ²	OK
Average low pressure > 8.5kg/cm ²	OK
Tcond, out - Tair, out ≥ 3°C	OK
Tair, in - Teva, out ≥ 2°C	NO
Tcond, out - Tair, out < -2°C	OK
Compressor in operation & Indoor Unit operation & Thermo On	OK
Error details	Breakaway Error of Indoor Heat Exchanger EVA Out sensor

2. How to check

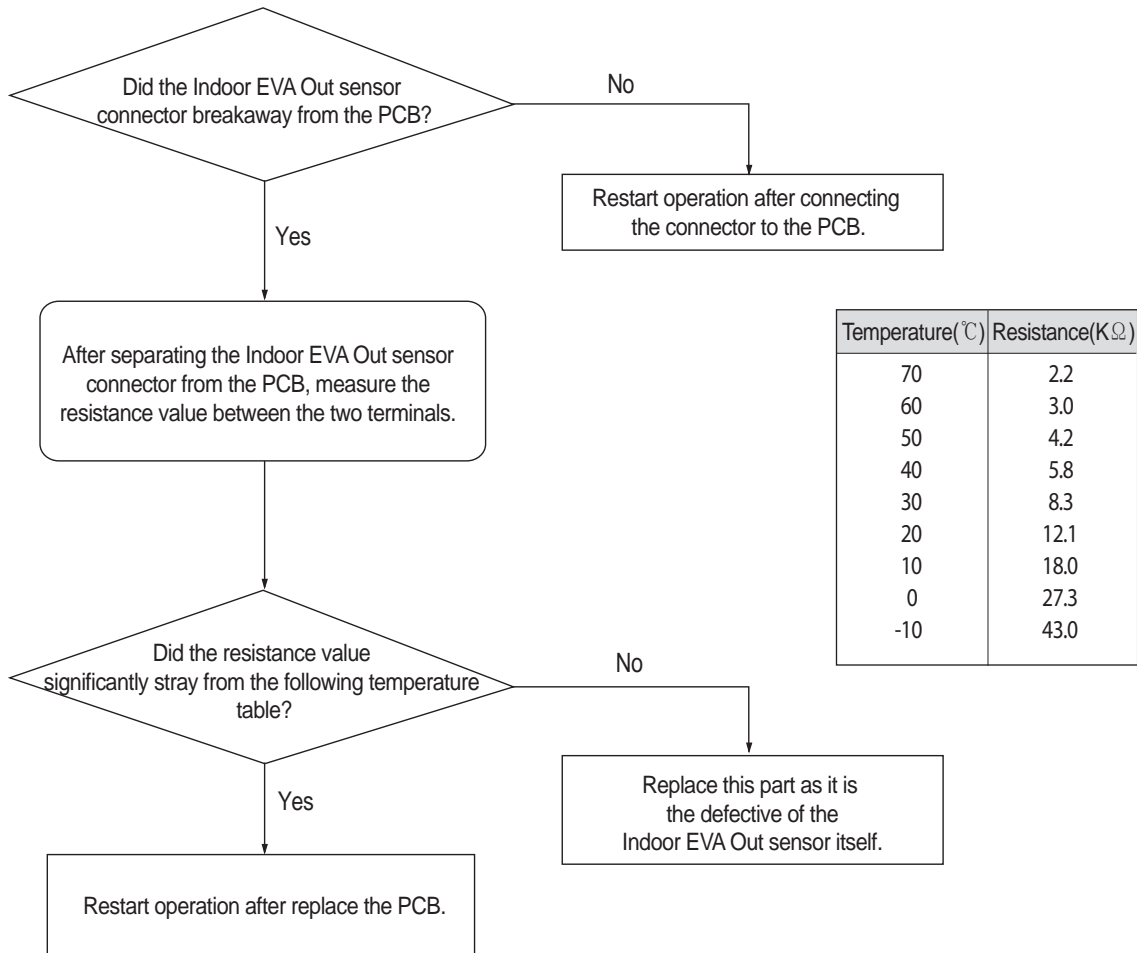

4-4-8 Simultaneous Indoor Heat Exchanger's EVA IN, OUT sensor dislocation error (Open/Short)

1. How to diagnose

1) During Cooling Operation

Tcond, out - Tair, out > 3°C	OK
Tair, in - Teva, out > 4°C	NO
Tair, in - Teva, out > 4°C	NO
Compressor in operation & Indoor unit operation & Thermo On	OK
Error details	Simultaneous indoor heat exchanger's EVA IN, OUT sensor dislocation error

2) During Heating operation

Average high pressure > 25kg/cm ²	OK
Average low pressure > 8.2kg/cm ²	OK
Teva, out - Tair, out ≥ 3°C	NO
Tair, in - Teva, out ≥ 2°C	NO
Tcond, out - Tair, out < -2°C	OK
Compressor in operation & Indoor unit operation & Thermo On	OK
Error details	Simultaneous Indoor heat exchanger's EVA IN, OUT sensor dislocation error

2. How to check

Check if an Indoor heat exchanger's EVA IN, OUT sensor has been dislocated then is correct after assembling.

4-4-9 Electronic Expansion Valve opening malfunction (2nd stage) - E 135

Outdoor unit display	1st detection : P703 (Outdoor Unit display only) 2nd detection : E 135 ↔ A ××× (××× : The address of the error occurred indoor unit)
Indoor unit display	×(Operation) ×(Timer) ●(Fan) ×(Filter) ×(Defrost)
Criteria	• Refer to the judgment method below.
Cause of problem	• Faulty Indoor Unit EEV action. (Refrigerant will leak into the stopped Indoor Unit.)

1. How to diagnose

- During Cooling operation, the temperature of the inlet or outlet of stopped Heat Exchanger is kept lower than 0°C for more than 20 minutes without cessation.
- Hydro Unit : During the defrost operation, detection from stop-side Indoor Unit. (Temperature of the inlet of Heat Exchanger is kept lower than 0°C for more than 20 minutes without cessation.)

2. How to check

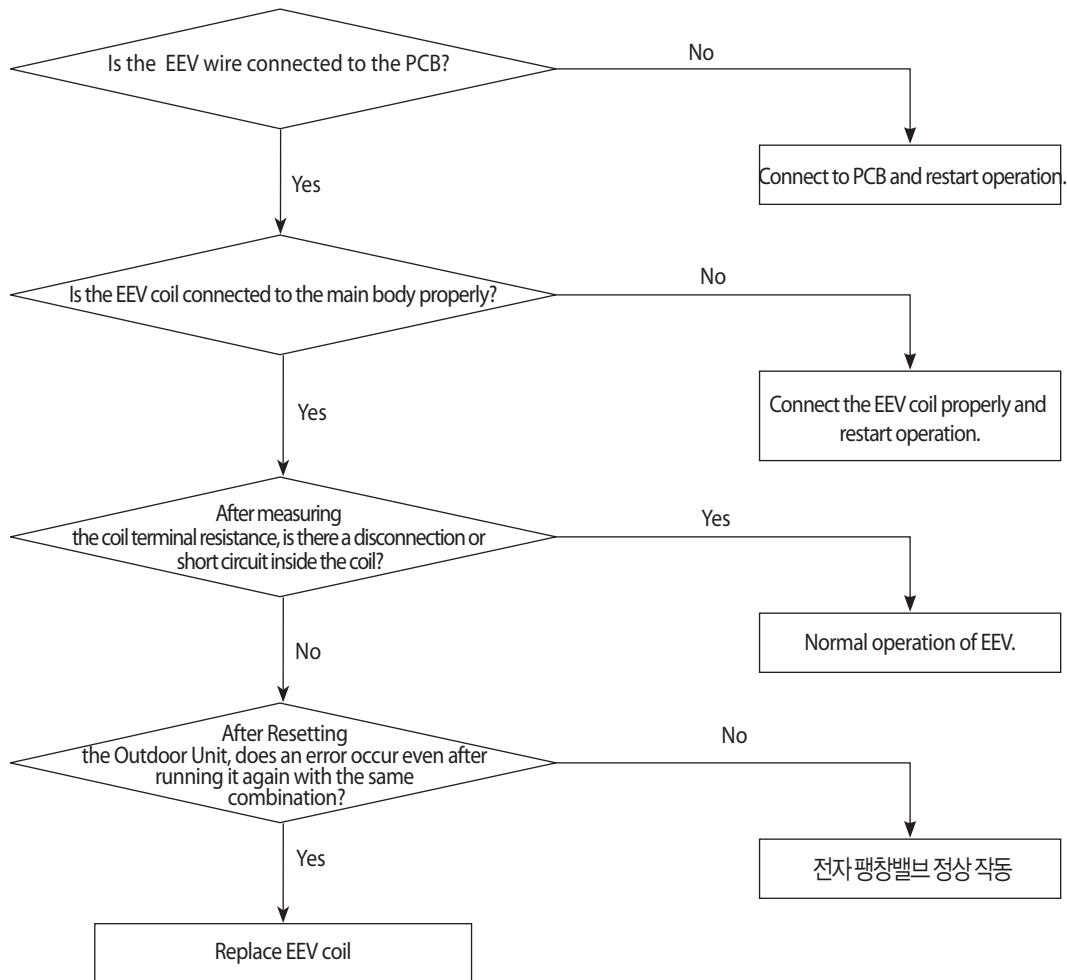

*** How to turn off the Hydro Unit E151**

- Hydro Unit PCB k1, k2 switch : At the same time push for more than 4 seconds.
- After resolving the cause of the error, restart operation.
(Excessive reset operation, can cause damage to the Heat Exchanger.)

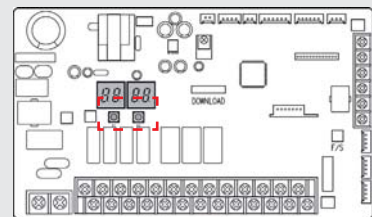

4-4-10 Breakdown of EEV (2nd)

1. How to diagnose

Detect only on cooling operation. (No detection during heating operation.)

During cooling operation, the temperature of the inlet or outlet ducts of heat exchanger is kept below 0°C for more than 20 minutes without cessation

2. How to check

1) Check if the wire of electronic expansion valve is correctly connected to the PCB of indoor unit.

2) Check if the coil of an electronic expansion valve is correctly plugged into the main body.

3) Check if there is any rust on the surface of the electronic expansion valve with naked eyes then check the resistance between each terminal to find any wire breaking or short circuit.

4) Press the RESET KEY (K3) of the outdoor unit then see if the same error occurs.

- In case of closure problem, operate the indoor unit in which the error has occurred.

- In case of opening problem, please do not operate the indoor unit in which the error has occurred.

5) If there is no problem with the above checkup items, replace the electronic expansion valve of the troubled indoor unit.

- As an electronic expansion valve replacement is tricky work that requires collecting refrigerants in all systems, please check the above items before replacement.

4-4-11 Problem with EEV closure (2nd)

1. How to diagnose

1) During Cooling operation(Each of the below conditions have to be met for at least 20 minutes.)

Tcond, out - Tair, out > 3°C	OK
Tair, in - Teva, out > 4°C	NO
Tair, in - Teva, out > 4°C	NO
Compressor in operation & Indoor unit operation & Thermo On	OK
Error details	Electrically operated valve closure breakdown

2) During heating operation (must satisfy all conditions below)

- When more than 2 indoor units are on Thermo On heating operation.
- When average high pressure is over 18kg/cm²
- 5 minutes after finishing Safety Start
- Keep Indoor units' $T(Eva_In) < T(Room) + 3^{\circ}C$ and $T(Eva_Out) < T(Room) + 3^{\circ}C$ condition for more than 5 minutes

2. How to check

- 1) Check if the wire of electronic expansion valve is correctly connected to the PCB of indoor unit.
- 2) Check if the coil of electronic expansion valve is correctly plugged into the main body.
- 3) Check if there is any rust on the surface of the electronic expansion valve with naked eye then check the resistance between each terminal to find any wire breaking or short circuit.
- 4) Press the RESET KEY (K3) of the outdoor unit then see if the same error occurs.
 - In case of closure problem, operate the indoor unit in which the error has occurred.
 - In case of opening problem, please do not operate the indoor unit in which the error has occurred.
- 5) If there is no problem with the above checkup items, replace the electronic expansion valve of the troubled indoor unit.
 - As electronic expansion valve replacement is tricky work that requires collecting refrigerants in all systems, please check the above items before replacement.

4-4-12 E 153 : Detection of Floating Switch of Indoor Unit's Drain Pump

Outdoor unit display	E 153 ← A ×××(x x x : The address of the error occurred indoor unit)
Indoor unit display	×(Operation) ×(Timer) ●(Fan) ●(Filter) ×(Defrost)
Criteria	• Refer to how to determine below
Cause of problem	• Due to the breakdown of a drain pump of the indoor unit, an increase in the water level in the drainage plate or defective detection sensor

* To release E153 error, you must reset the power of the indoor unit.

1. How to check

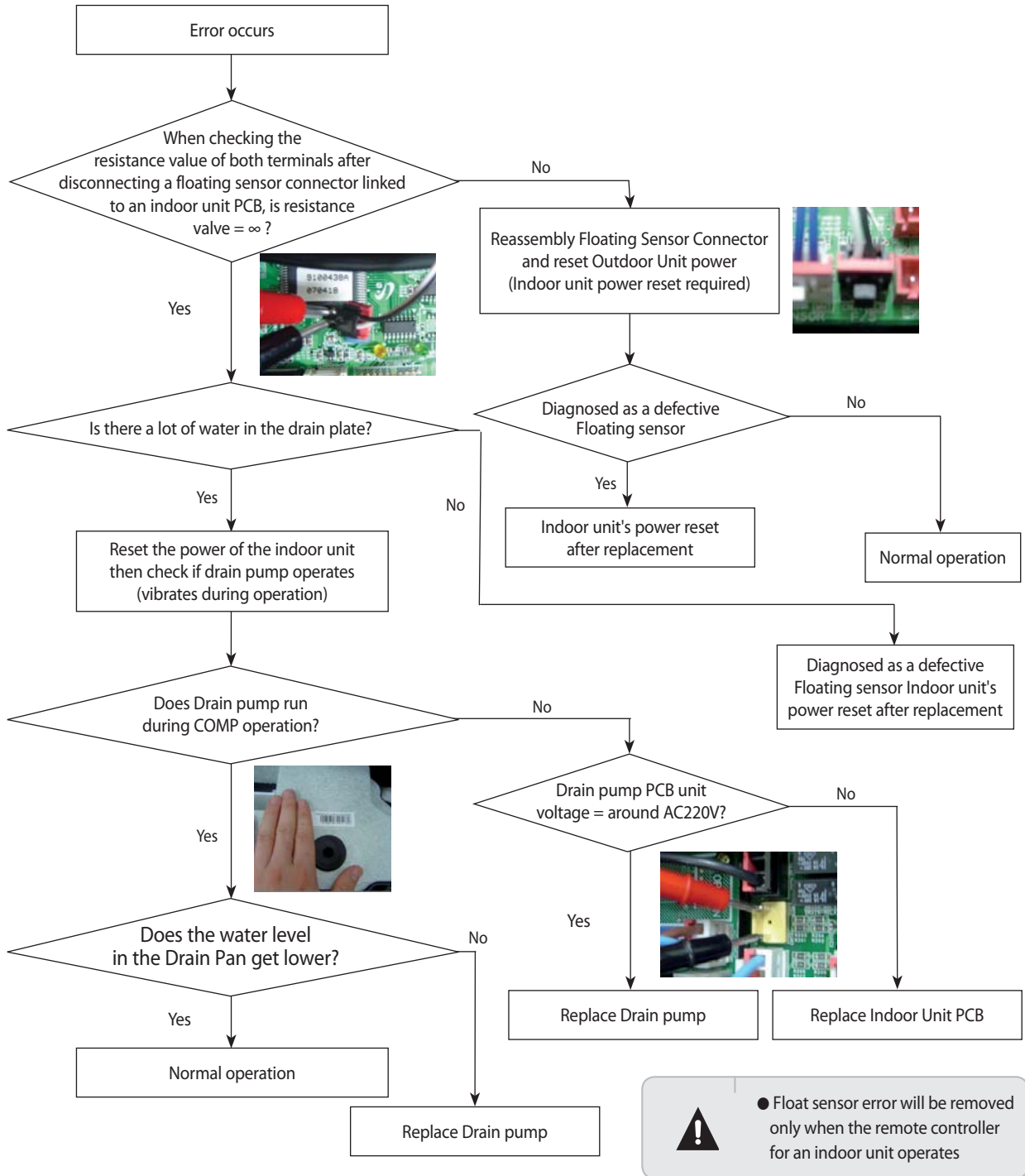

4-4-13 The operational error of Indoor Unit's Fan Motor

Outdoor unit display	E 154 ↔ A ^{xxx} (_{xxx}) : The address of the error occurred indoor unit)
Indoor unit display	×(Operation) ×(Timer) ●(Fan) ×(Filter) ×(Defrost)
Criteria	• Refer to how to determine below
Cause of problem	• The operational error of the fan motor of No. XXX indoor unit

1. How to diagnose
 - 1) Occurs when RPM valve fails to feedback to MICOM at a PID control-type fan motor

2. How to check
 - 1) Check HALL IC connector that carries out feedback of RPM value.
 - 2) If a fan motor operation capacitor is a PCB separating type, check the connection terminal.
 - 3) Check the operational status of the fan motor.
 - 4) If there is no problem with the above checkup items, replace the PCB.

4-4-14 Mixed operation Error (Only applicable to Heat Pump Model/Not to HR model)

- Mixed operation error is applicable only to Heat Pump Model and not to HR model.
- Mixed operation error is not due to a product problem but is displayed when the operational mode input in an indoor unit is different from current operational status (other indoor unit's operational mode).
- Check the operational mode of outdoor unit or other indoor unit then re-enter or stop the operational mode of the relevant unit.
- If it is necessary to apply a different operational mode to an indoor unit from others, please stop other indoor units then operate the indoor unit.

4-4-15 EEPROM error

Outdoor unit display	E 162
Indoor unit display	×(Operation) ●(Timer) ●(Fan) ●(Filter) ×(Defrost)
Criteria	• Communication failure between EEPROM and MICOM
Cause of problem	• PCB replacement due to defective EEPROM

1. How to check

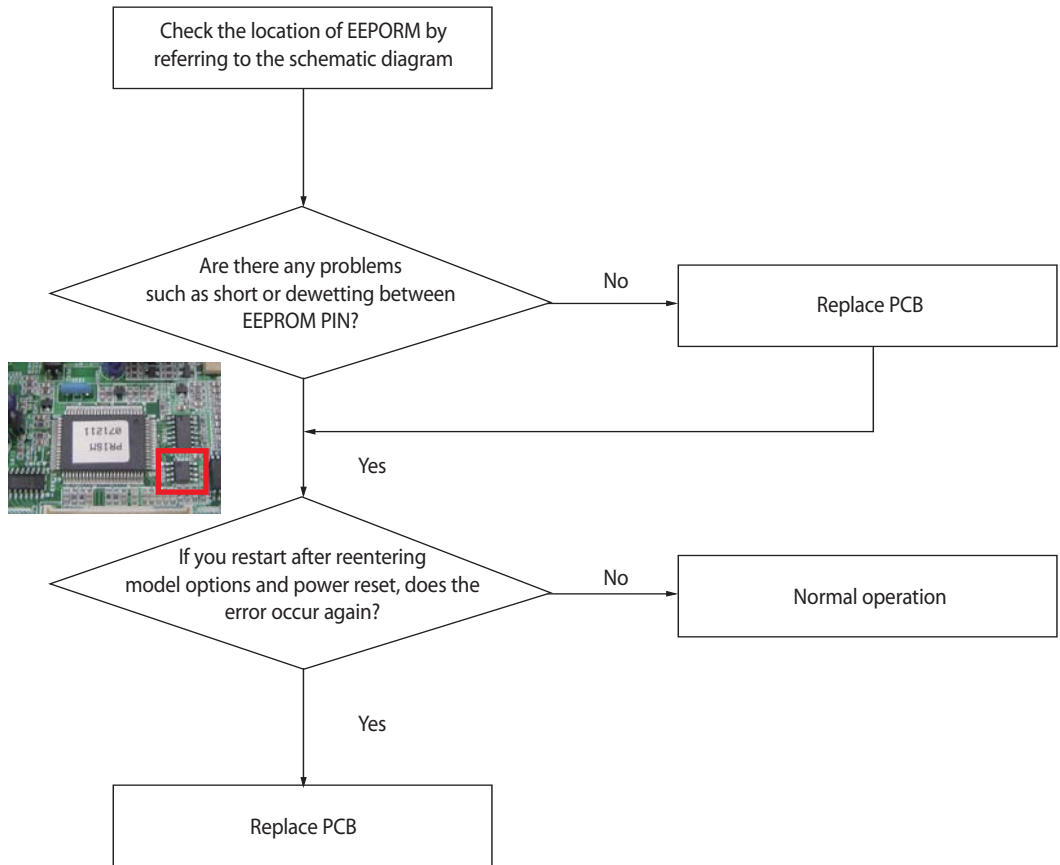

4-4-16 Option error of the Remote Controller for an Indoor Unit

Outdoor unit display	<i>E 163</i>
Indoor unit display	●(Operation) ●(Timer) ●(Fan) ●(Filter) ●(Defrost)
Criteria	• Display number type of indoor unit – E163 occurs, Lamp type – all lamps flash
Cause of problem	• Missed or erroneous input of remote controller options

- Check relevant remote controller options for each model then enter correct options

4-4-17 Error due to confused use of Fahrenheit and Celsius

Outdoor unit display	<i>E 170</i>
Indoor unit display	×(Operation) ●(Timer) ●(Fan) ●(Filter) ×(Defrost)
Criteria	• Display number type of indoor unit – E170 occurs, Lamp type – all lamps flash • Occurs in an indoor unit with Celsius setting
Cause of problem	• Missed input of remote controller options

- Check relevant remote controller options for each model then enter correct options
- As this happens only in a Celsius setting model, it is necessary to reenter option codes for error-free models in a region where Celsius is used.

4-4-18 Simultaneous opening of Cooling/heating MCU SOL Valves 1st/2nd

- During the first detection, as the system restarts after making an automatic stop to check a problem with the system
- During the second detection, please refer to the following check-up methods.

1. How to check

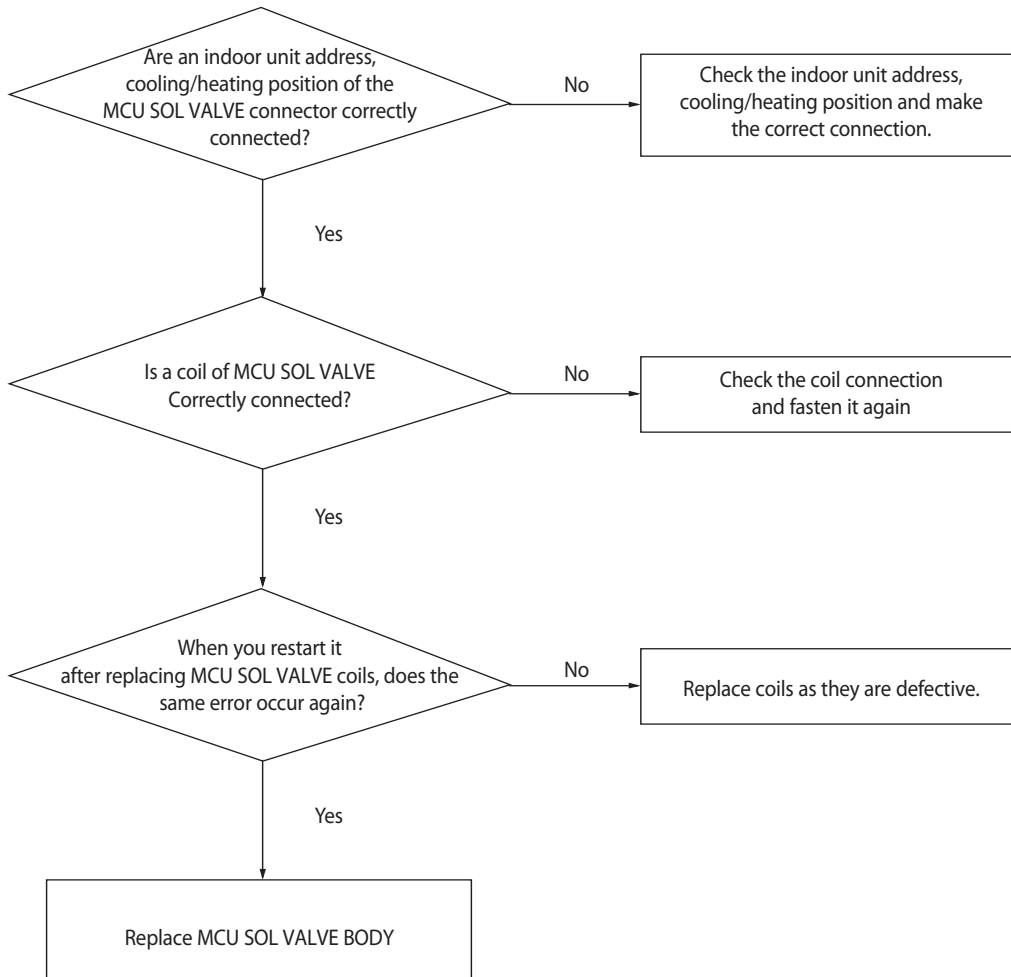

4-4-19 Error due to incorrect Indoor Unit Power/Communication Cable Connection

Outdoor unit display	<i>E 185</i>
Indoor unit display	<i>E 185</i> (wall mount type)
Criteria	• Check for Power input(220V) for the Terminal block(F1/F2).
Cause of problem	• Apply power (220V) to the terminal of the indoor unit communication block (F1/F2)

- Check for disconnected line after turning off the Main power.

4-4-20 SPI Feedback Error

Outdoor unit display	<i>E 186</i>
Indoor unit display	●(Operation) ●(Timer) ×(Fan) ●(Filter) ×(Defrost)
Criteria	• Check if the output of SPI Feedback is 12V
Cause of problem	• SPI defect

1. How to check

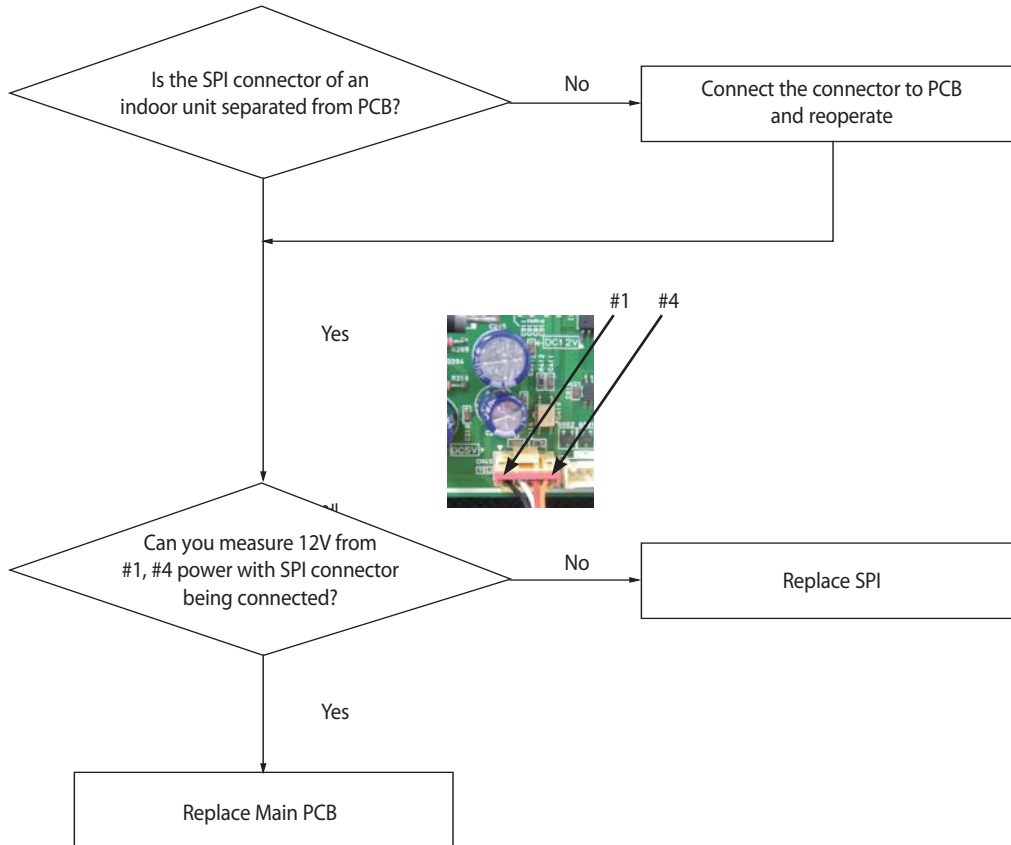

4-4-21 Outdoor Unit Pipe Inspection Error

Outdoor Unit Display	<i>E 190</i> : No change of EVA IN or wrong EVAN IN change during pipe inspection. <i>E 191</i> : No change of EVA OUT or wrong EVA OUT change during pipe inspection.
Indoor Unit Display	-
Judgment Method	• Refer to the judgment method below
Special Cause	• The liquid pipe/gas pipe of the indoor unit is not correctly connected to the port set in MCU.

1. Judgment Method

- Check if the indoor address settings are the same for the address of the indoor units connected to each port of the MCU and the address of the indoor units of the relevant MCU ports.
- Check if the indoor unit usage setup switch is turned on for the MCU port connected to the indoor unit.

4-4-22 Communication Error between Indoor and Outdoor Units during Tracking

Outdoor unit display	E201
Indoor unit display	×(Operation) ●(Reservation) ●(Blast) ×(Filter) ×(Defrost)
Judgment Method	· Communication error between indoor and outdoor units.
Cause of problem	· Refer to the judgment method below.

1. Cause of problem

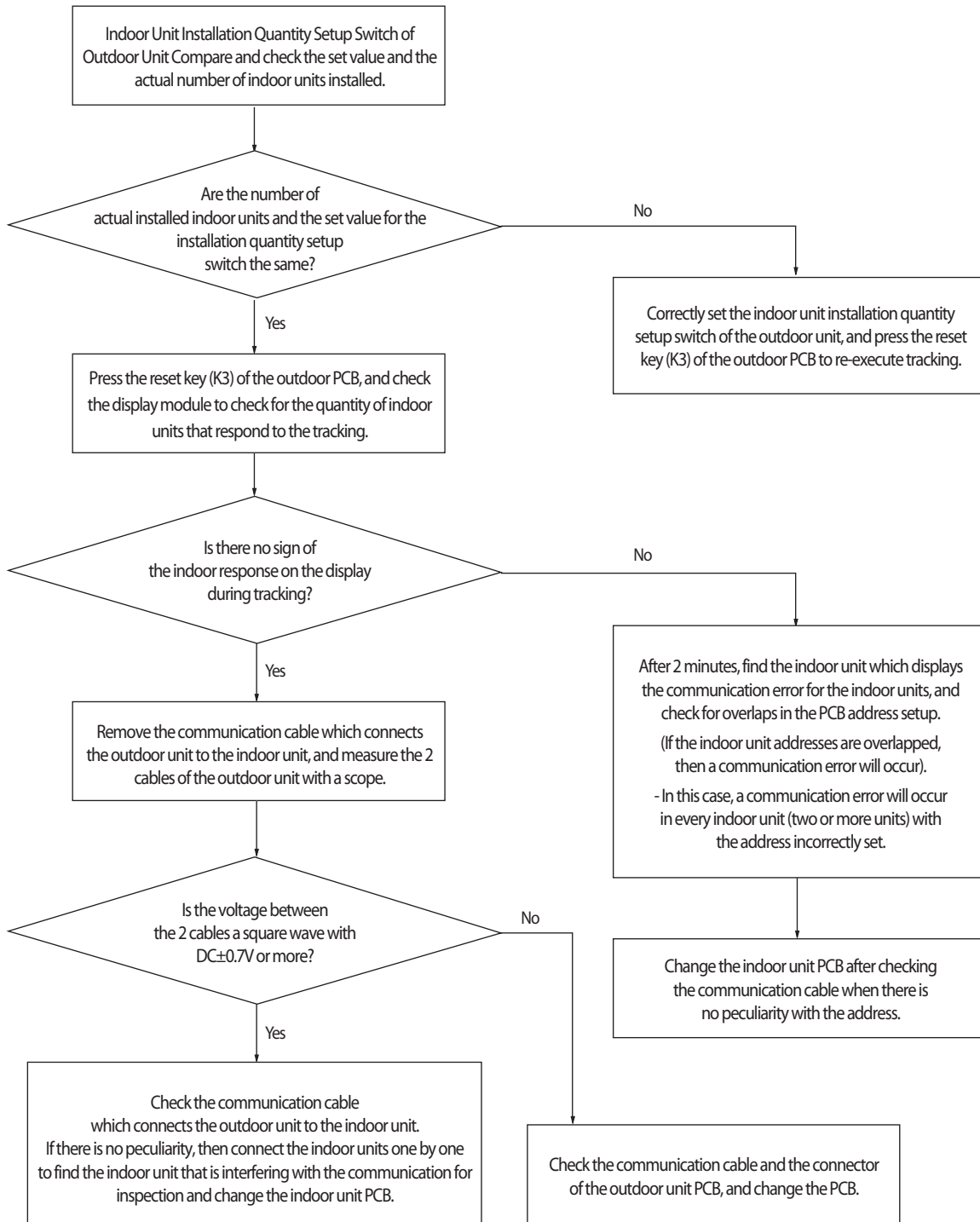

4-4-23 Communication Error between Indoor and Outdoor Units after Tracking

Outdoor unit display	E202
Indoor unit display	×(Operation) ●(Reservation) ●(Blast) ×(Filter) ×(Defrost)
Judgment Method	· Outdoor unit is unable to communicate for two minutes during operation. (no reception of relocation)
Cause of problem	· Communication error between indoor and outdoor units and setup error of indoor unit installation quantity setup switch.

1. Cause of problem

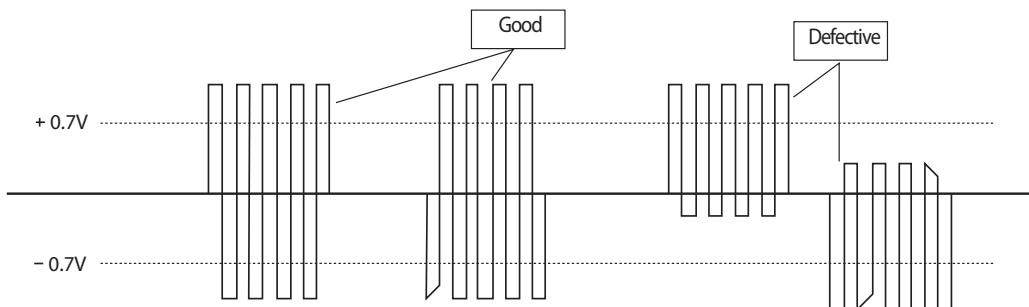
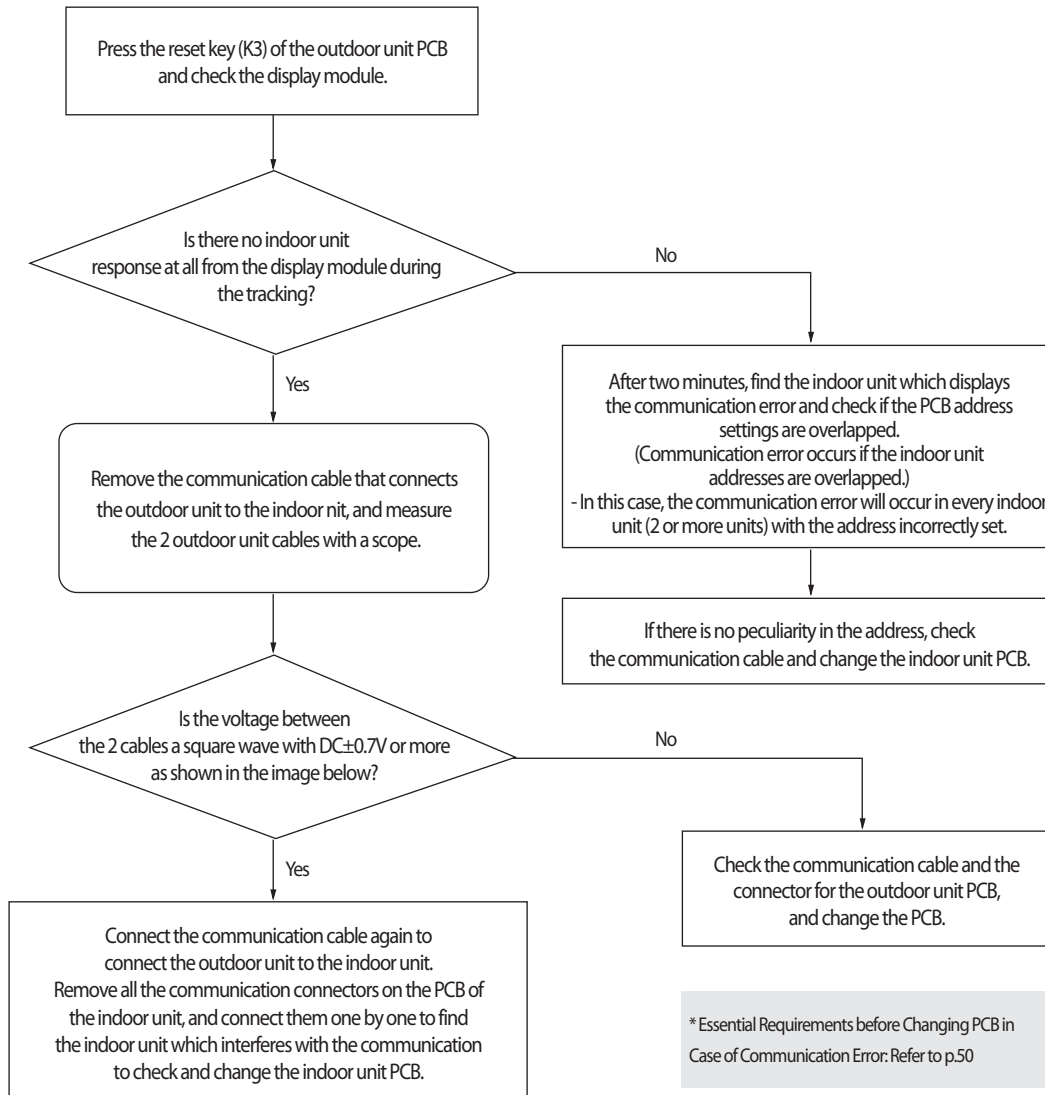

4-4-24 Communication error between main and sub Unit of outdoor unit or between outdoor units

Outdoor unit display	E203
Indoorunit display	-
Judgment Method	· Refer to the judgment method below.
Cause of problem	· Communication error between outdoor units.

1. Cause of problem

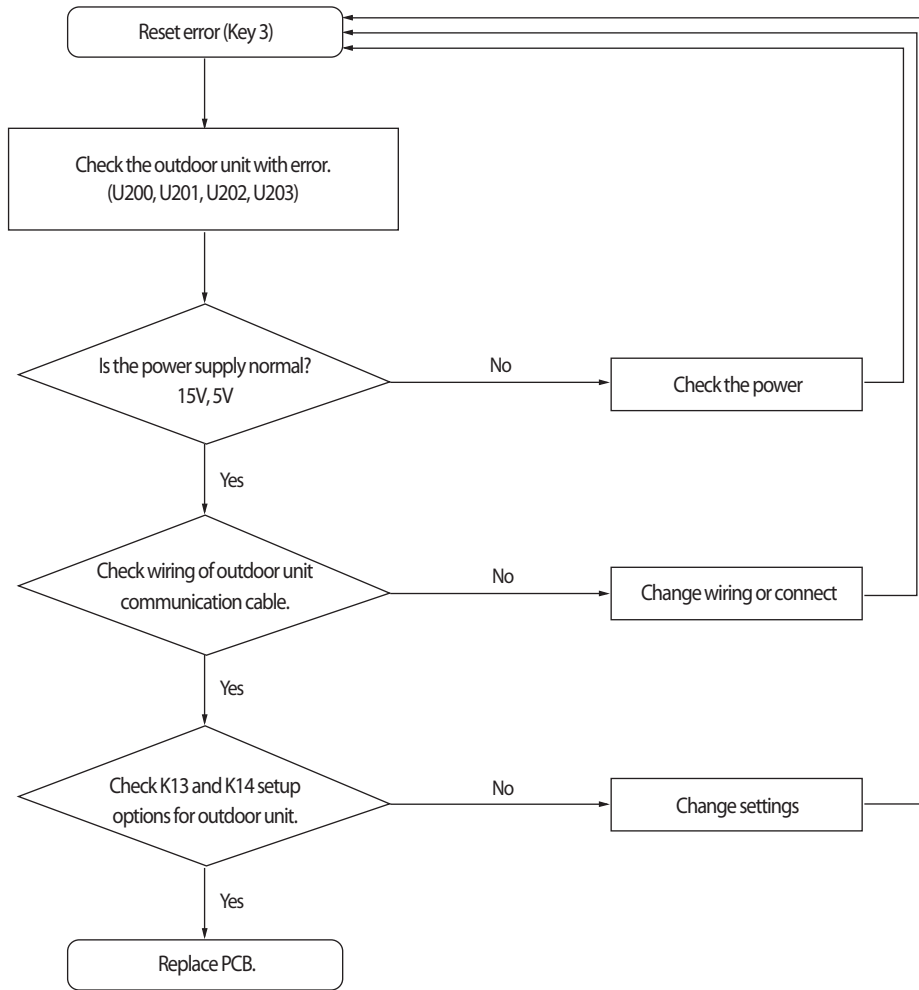

Essential Requirements before Changing PCB in Case of Communication Error: Refer to p.59

4-4-25 Communication Error between MCU and Outdoor Unit

Outdoor Unit Display	E204
Indoor Unit Display	-
Judgment Method	• Communication Error between MCU and outdoor unit
Special Cause	• Reference below

1. Inspection Method

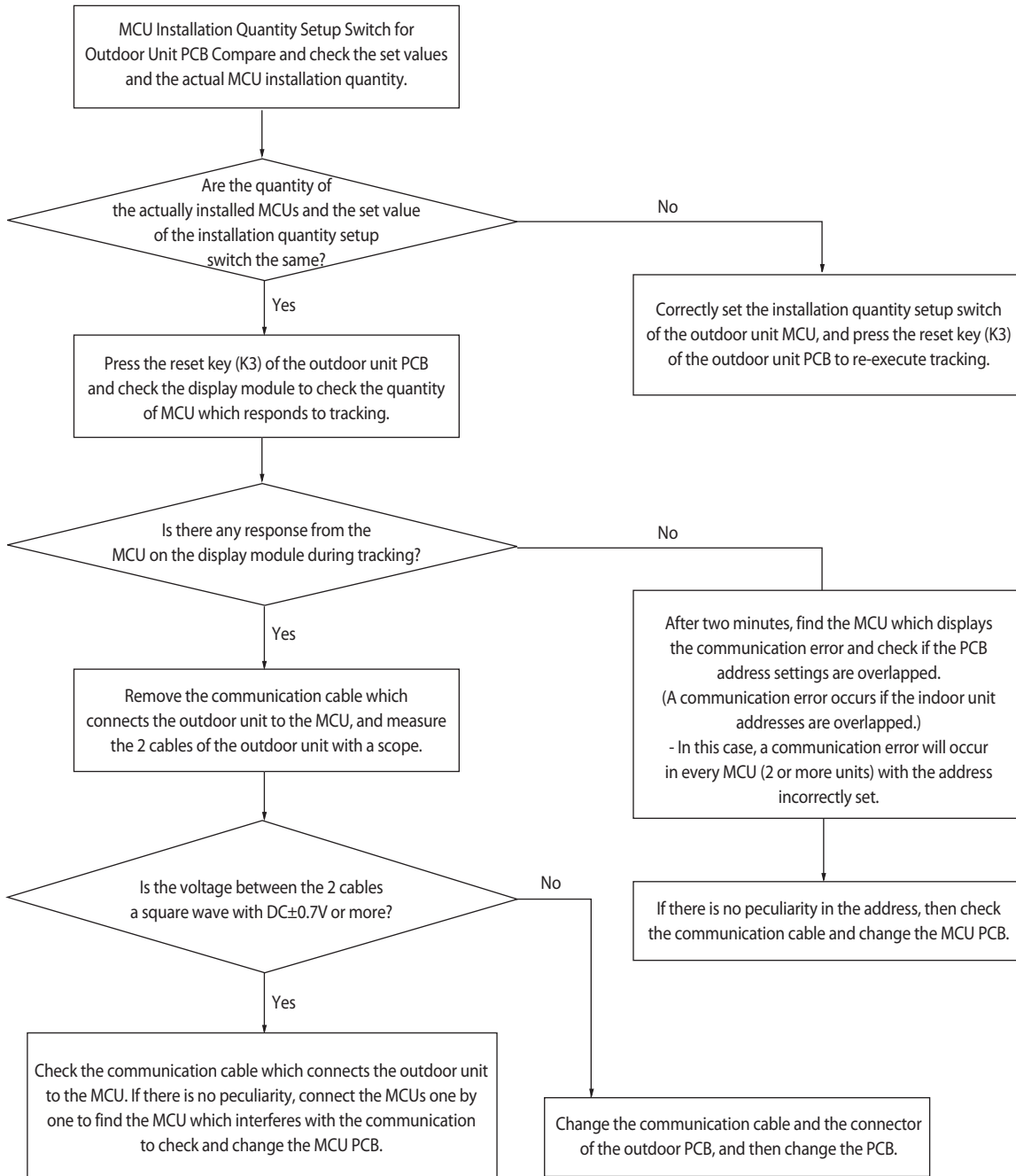

※ Essential Requirements before Changing PCB in Case of Communication Error: Refer to p.4-80

4-4-26 Internal Communication error of the Outdoor Unit C-Box

Outdoor unit display	E205
Indoorunit display	×(Operation) ● (Reservation) ● (Blast) ×(Filter) ×(Defrost)
Judgment Method	· Communication error between the C-Box PCB
Cause of problem	· Communication wire inside the C-Box is unconnected · Main PCB defective

1. Cause of problem

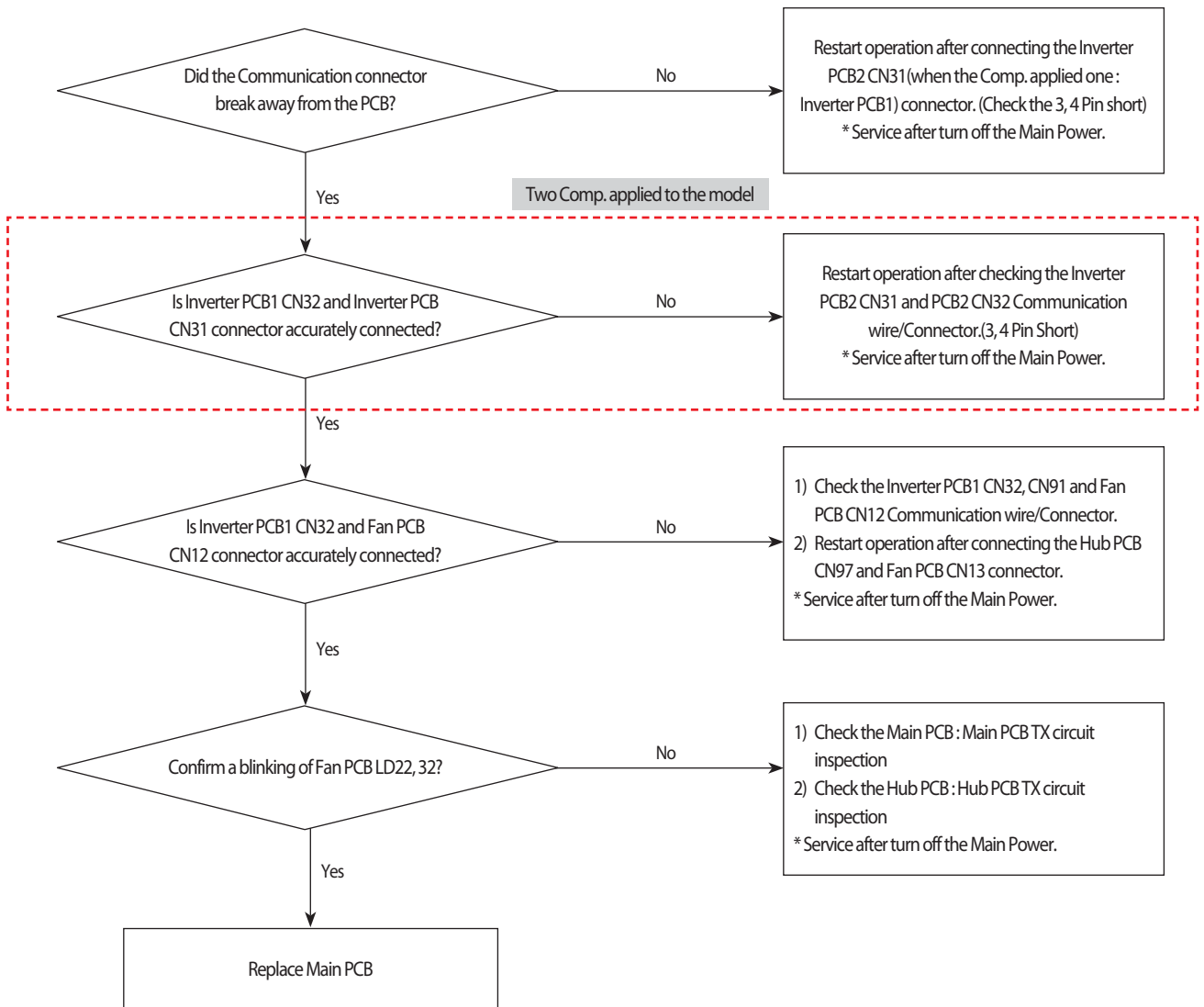

4-4-27 Internal PCB Communication error of the Outdoor Unit C-Box

Outdoor unit display	E206
Indoorunit display	×(Operation) ● (Reservation) ● (Blast) ×(Filter) ×(Defrost)
Judgment Method	· PCB does not respond to the invoked Main PCB
Cause of problem	· C-Box internal Inverter PCB, Fan PCB, Hub PCB defective

1. Cause of problem

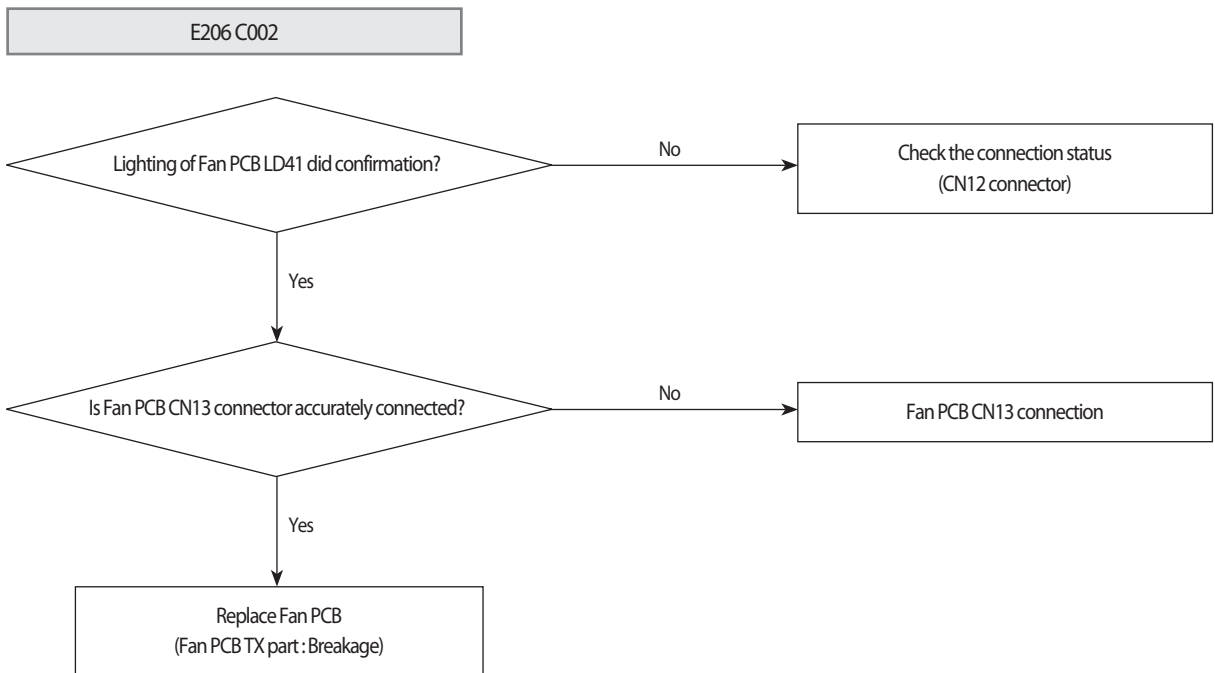
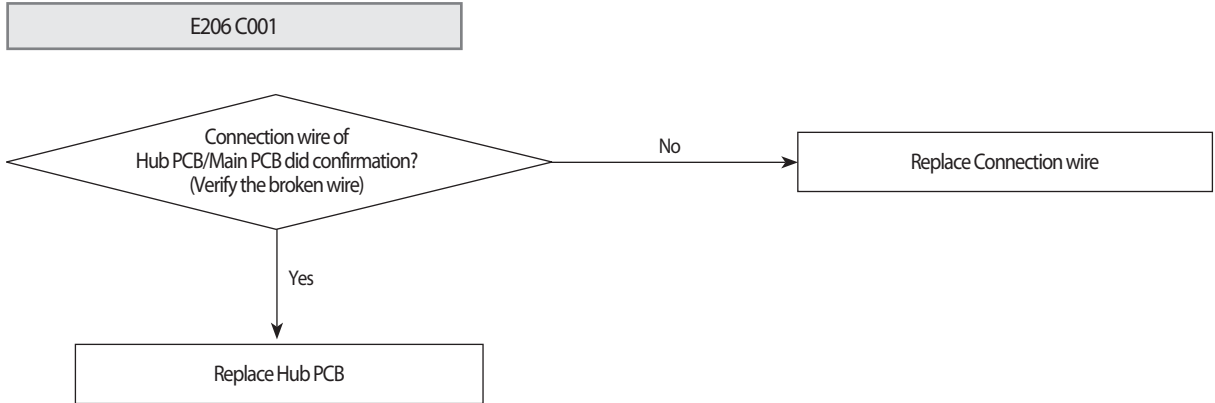

4-4-28 Communication Error between MCU and Outdoor Unit after Tracking is Completed

Outdoor Unit Display	E2 10
Indoor Unit Display	-
Judgment Method	• Outdoor unit is unable to communicate for two or more minutes during operation (no reception of relocation)
Special Cause	• Communication error between indoor and outdoor units and setup error of indoor unit installation quantity setup switch

1. Inspection Method

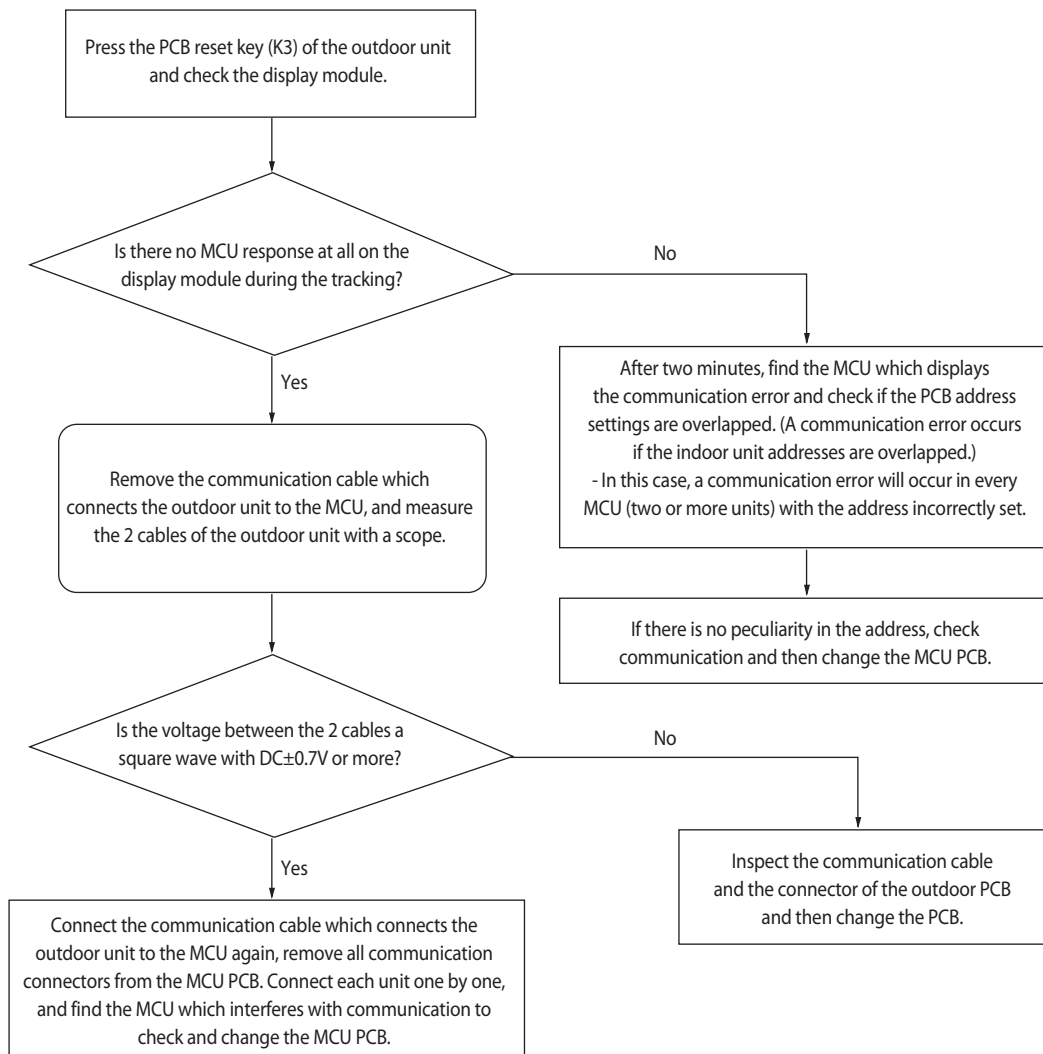

※ Essential Requirements before Changing PCB in Case of Communication Error: Refer to p.4-80

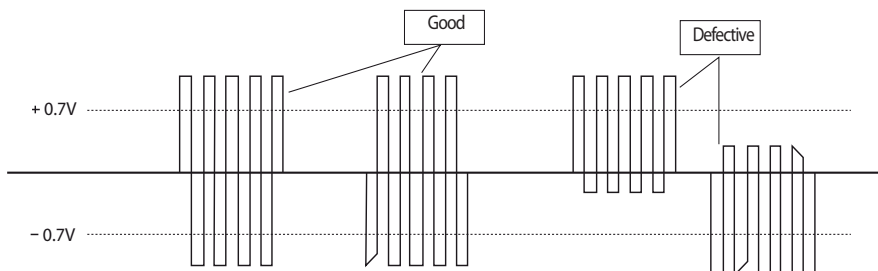

4-4-29 MCU branch part setup error – inconsecutive connection with the use of 2 branch parts

Outdoor unit display	E211
Indoor unit display	×(Operation) ●(Timer) ●(Fan) ●(Filter) ×(Defrost)
Criteria	• When 2 branch parts are used for one indoor unit without connecting them consecutively.
Cause of problem	• Branch part assembly error

1. How to check

Find an MCU that is composed as the following picture to carry out assembly of branch part again. After completing the re-setting, press K3 button on the button to reset or turn it off to restart.

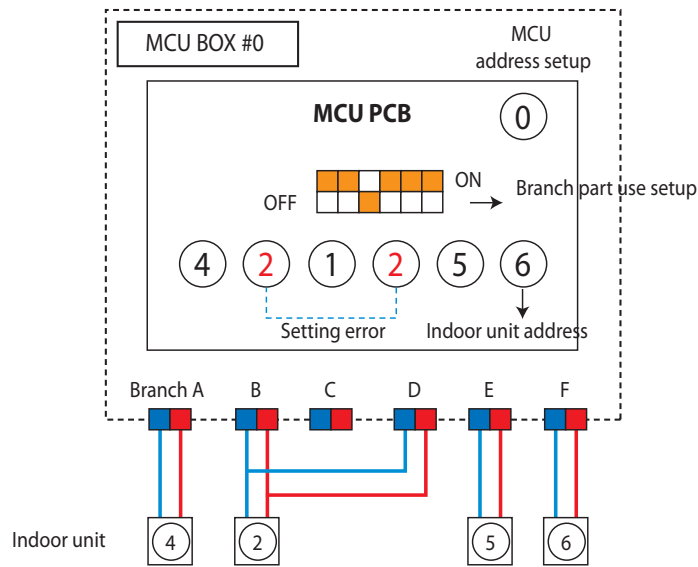

4-4-30 MCU branch part setup error – Repeated setup for the same address over 3 times

Outdoor unit display	E2 12
Indoor unit display	×(Operation) ●(Timer) ●(Fan) ●(Filter) ×(Defrost)
Criteria	• The same indoor unit address was setup more than 3 times in MCU
Cause of problem	• MCU indoor unit address setting error

1. How to check

Find an MCU that is composed as the following picture to carry out assembly of branch part again. After completing the re-setting, press K3 button on the button to reset or turn it off to restart.

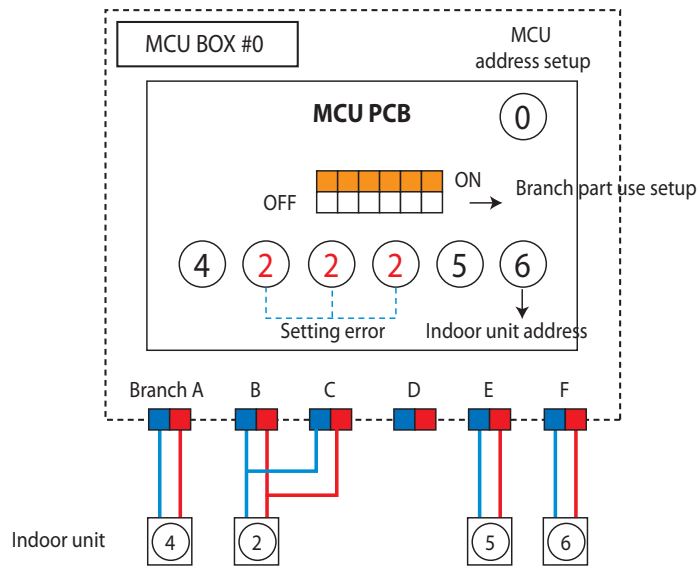

4-4-31 MCU branch part setup error – non-installed address setup

Outdoor unit display	E2 13
Indoor unit display	×(Operation) ●(Timer) ●(Fan) ●(Filter) ×(Defrost)
Criteria	• If there is an indoor unit that is not installed among MCU registered indoor units
Cause of problem	• Indoor unit, with the assigned address on MCU, not installed.

1. How to check

Find an MCU that is composed as the following picture to carry out assembly of branch part again. After completing the re-setting, press K3 button on the button to reset or turn it off to restart.

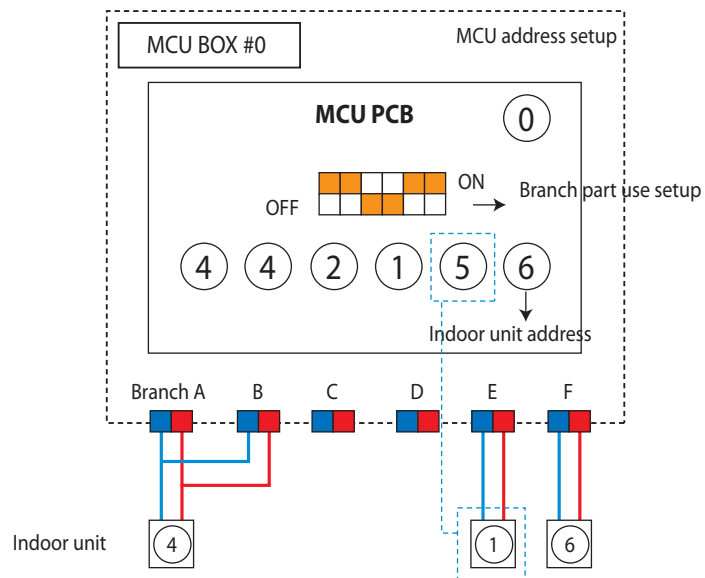

4-4-32 Setup Error for MCU Branch part – Setup Error for MCU Quantity Used

Outdoor Unit Display	E2 14
Indoor Unit Display	×(Operation) ●(Reservation) ●(Blast) ●(Filter) ×(Defrost)
Judgment Method	<ul style="list-style-type: none"> Occurs when the quantity of MCU is incorrectly set by the outdoor unit. Occurs when same addresses are found when two or more MCU are connected.
Special Cause	<ul style="list-style-type: none"> Outdoor unit MCU setup and same address errors when connecting two or more MCUs .

- Inspection Method :** Re-check the MCU quantity setup switch from the outdoor unit.
 Check for overlaps in each MCU address setup switch.
 To use, reset by pressing the K3 button of the outdoor unit after the reset is completed, or reset after turning off the power and then turn it on again.

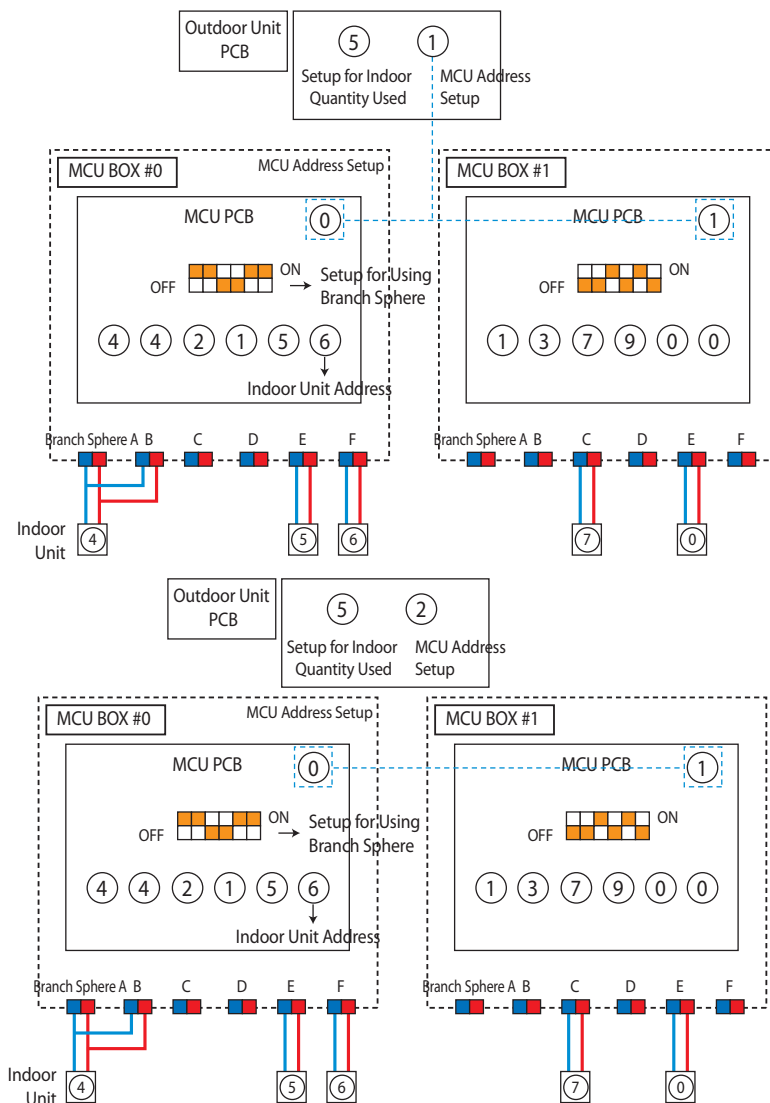

4-4-33 MCU branch part setup error – Overlapping Indoor unit Address setup

Outdoor unit display	E2 15
Indoor unit display	×(Operation) ●(Timer) ●(Fan) ●(Filter) ×(Defrost)
Criteria	• Occurs when an indoor unit address setup switch in MCU has been overlapped
Cause of problem	• Repeated indoor unit address

1. How to check

Check the setup switch for the number of indoor units in MCU

After completing resetting, press the outdoor unit's K3 button to reset or turn off to restart.

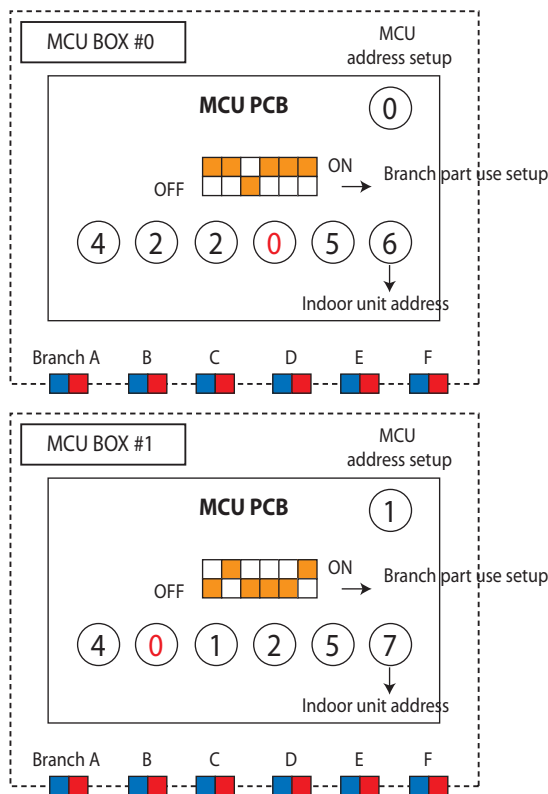

4-4-34 MCU branch part setup error – Set as being used without connection to an Indoor unit

Outdoor unit display	E2 16
Indoor unit display	×(Operation) ●(Timer) ●(Fan) ●(Filter) ×(Defrost)
Criteria	• Occurs when MCU PIPE is set as being used, yet not connected to an indoor unit
Cause of problem	• Pipe is not installed to the indoor unit with assigned address on MCU

1. How to check

Adjust the Dip switch that sets up the use of MCU branch part to 'Not-Used'. After completing resetting, press the outdoor unit's K3 button to reset or turn off to restart.

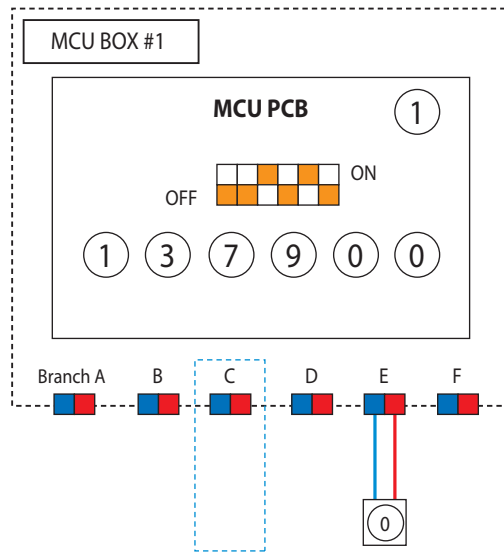

4-4-35 MCU branch part setup error – Connect an Indoor unit to a branch part not being used

Outdoor unit display	E2 17
Indoor unit display	×(Operation) ●(Timer) ●(Fan) ●(Filter) ×(Defrost)
Criteria	• Occurs when MCU PIPE is turned off, yet an indoor unit is registered
Cause of problem	• Indoor unit connection to the unused branch part

1. How to check

Check the actual use of the branch part. If it is used, turn on the Dip switch for branch part setup. After completing resetting, press the outdoor unit's K3 button to reset or turn off to restart.

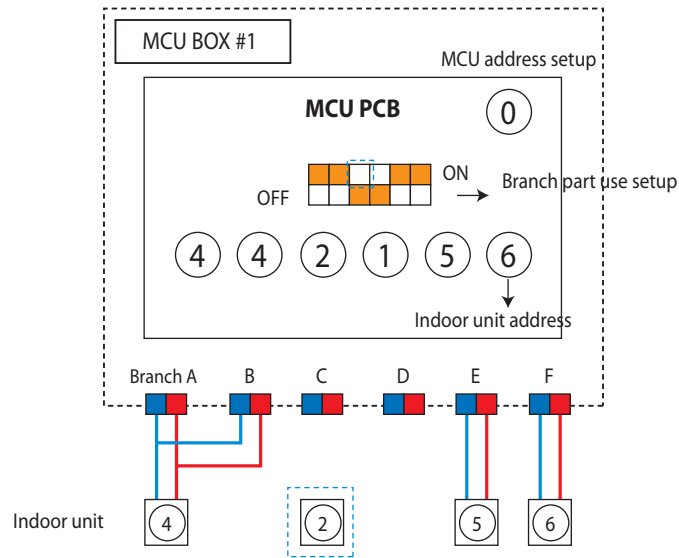

4-4-36 MCU branch part setup error – Connect more Indoor units than what is actually set up in MCU

Outdoor unit display	E2 18
Indoor unit display	×(Operation) ●(Timer) ●(Fan) ●(Filter) ×(Defrost)
Criteria	• Occurs when the number of indoor units installed exceeds that registered in MCU
Cause of problem	• Number of indoor units exceeds number of indoor units entered on MCU setting

1. How to check

Check the number of indoor units connected to MCU then readjust the switch for the number of units
 After completing resetting, press the outdoor unit's K3 button to reset or turn off to restart.

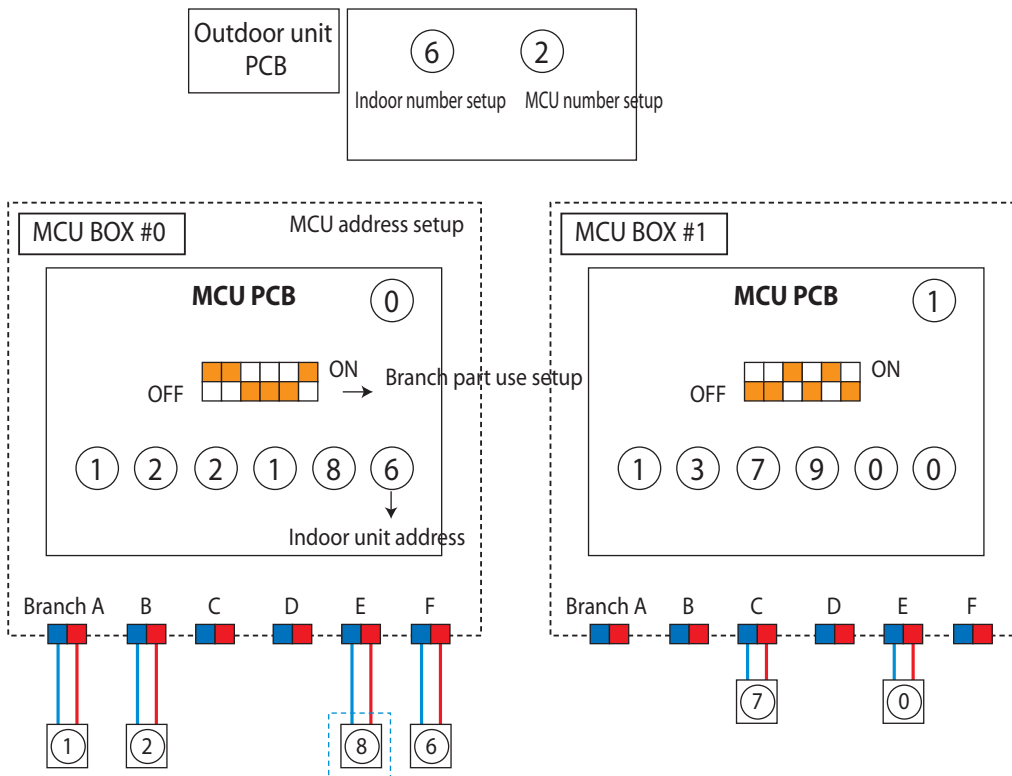

4-4-37 Outdoor Temperature Sensor Error

Outdoor unit display	E221
Indoorunit display	● (Operation) ×(Reservation) ● (Blast) ×(Filter) ×(Defrost)
Judgment Method	· Refer to the judgment method below.
Cause of problem	· Outdoor temperature sensor Open/Short is defective.

1. Cause of problem

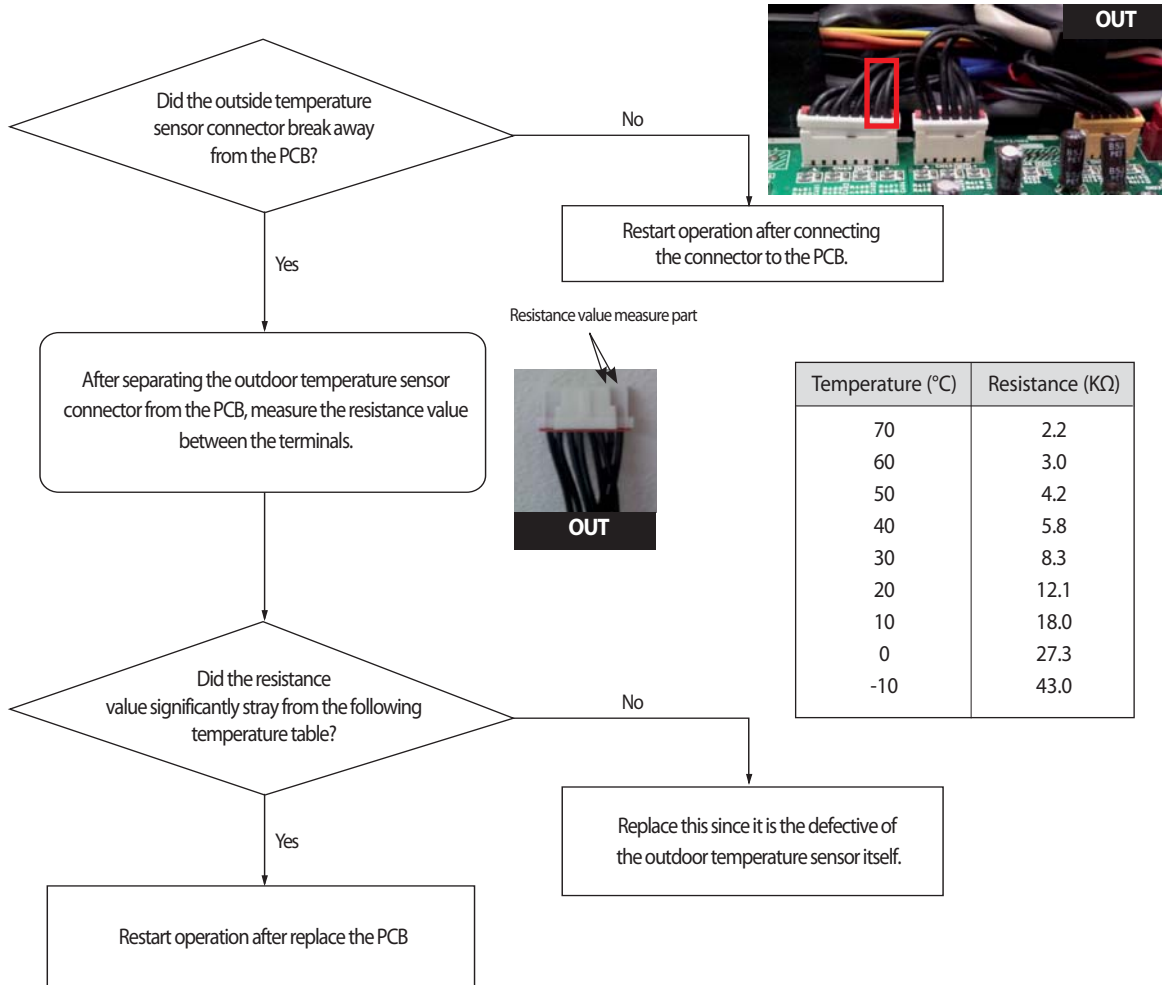

4-4-38 Outdoor Temperature dislocation error

1. How to check

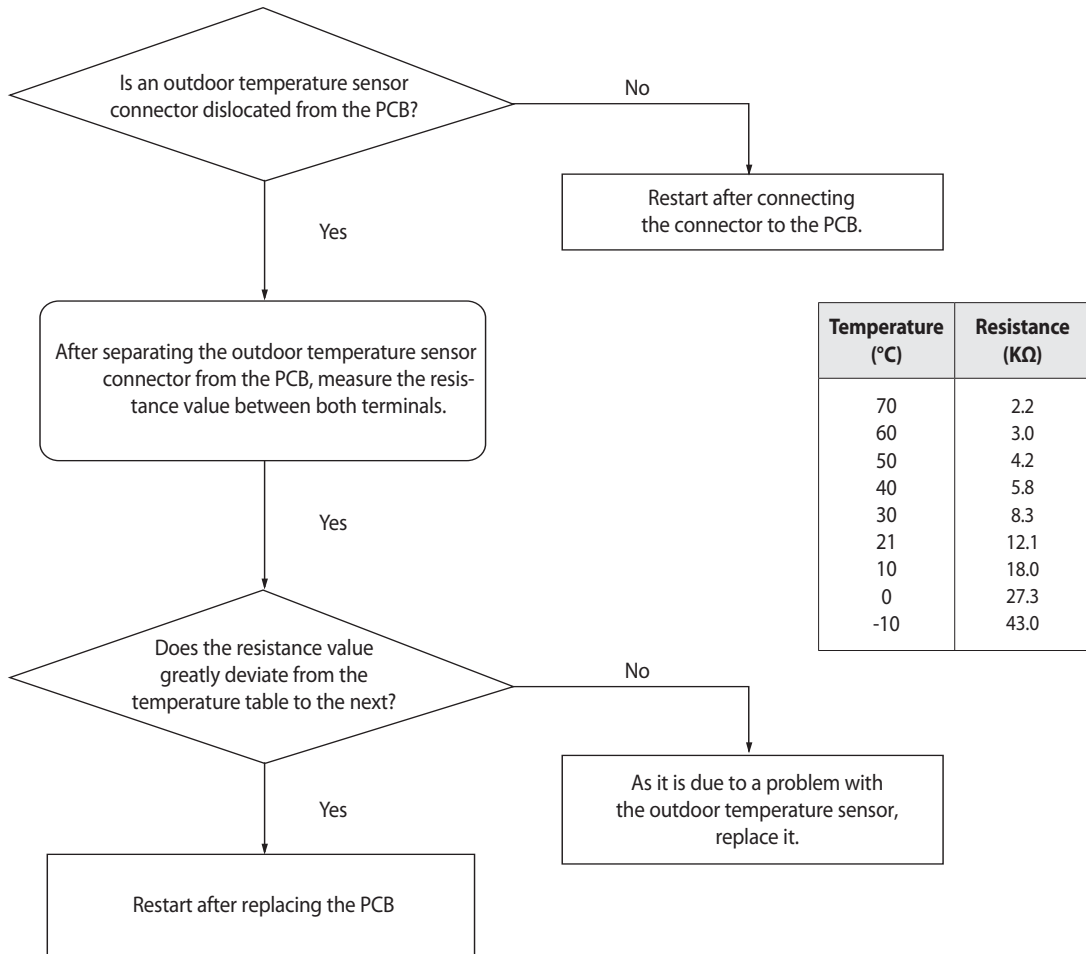

4-4-39 Cond Out Temperature Sensor Error (Open/Short)

Outdoor unit display	E231
Indoorunit display	● (Operation) ×(Reservation) ● (Blast) ×(Filter) ×(Defrost)
Judgment Method	· Refer to the judgment method below.
Cause of problem	· Disconnection or breakdown of relevant sensor.

1. Cause of problem

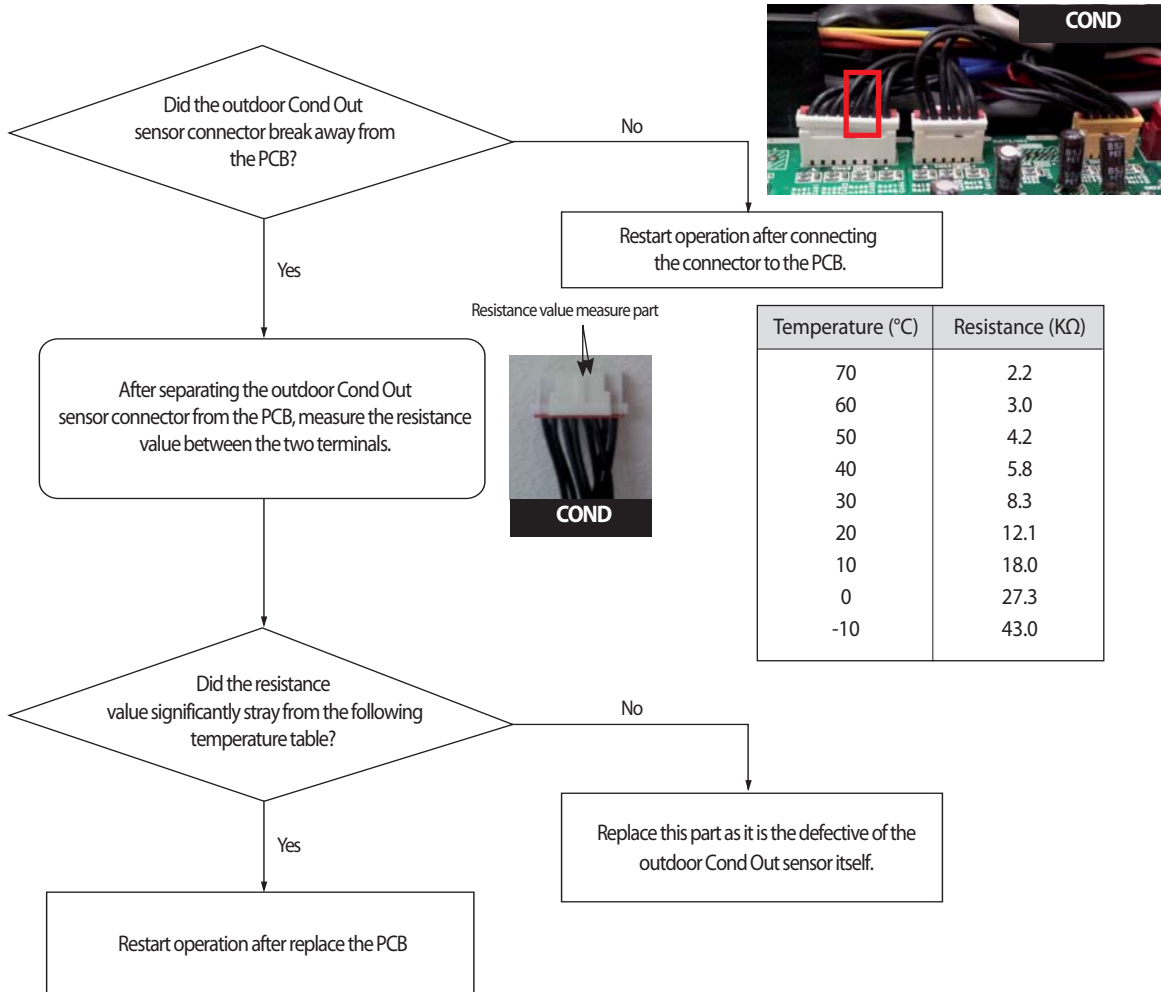

4-4-40 Outdoor Cond Out sensor breakaway error

Outdoor unit display	E241
Indoor unit display	×(Operation) ●(Reservation) ●(Blast) ●(Filter) ×(Defrost)
Judgment Method	· Refer to the judgment method below.
Cause of problem	· Outdoor Cond Out sensor breakaway/defective/ relevant path blocked.

1. Judgment Method

- 1) No inspection for Cooling operation.
- 2) For heating operation (Each of the conditions below needs to be satisfied for more than 20 minutes.)

High pressure average > 25kg/cm ²	OK
Low pressure average < 8.5kg/cm ²	OK
Teva, out - Tair, in ≥ 3°C	OK
Teva, in - Tair, in ≥ 2°C	OK
Tcond, out - Tair, out ≤ 0°C	NO
Every compressor is in operation & indoor unit operation and Thermo On	OK
Error Content	Outdoor Cond Out sensor breakaway error

2. Cause of problem

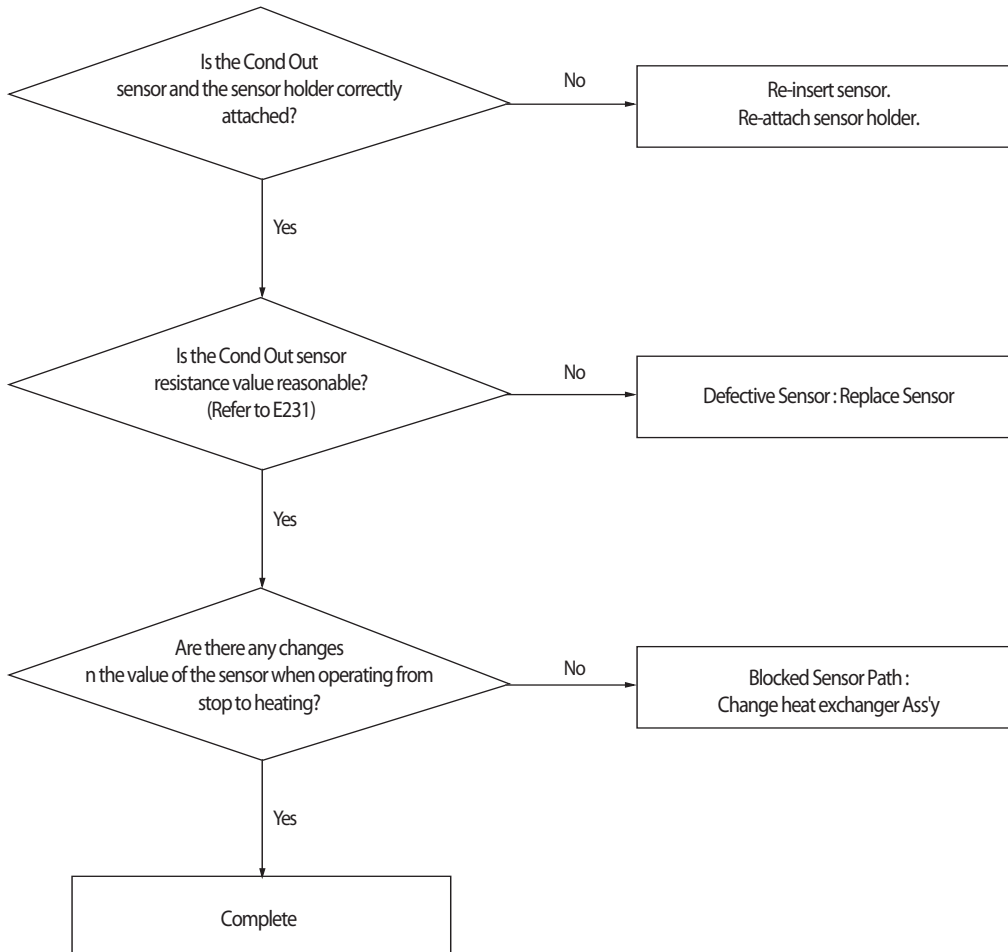

4-4-41 Digital Compressor Discharge Temperature Sensor Error (OPEN/SHORT)

Outdoor Unit Display	E251
Indoor Unit Display	●(Operation) ×(Reservation) ●(Blast) ×(Filter) ×(Defrost)
Judgment Method	• Refer to the inspection method below,
Special Cause	• Digital compressor discharge temperature sensor OPEN/SHORT problem

1. Inspection Method

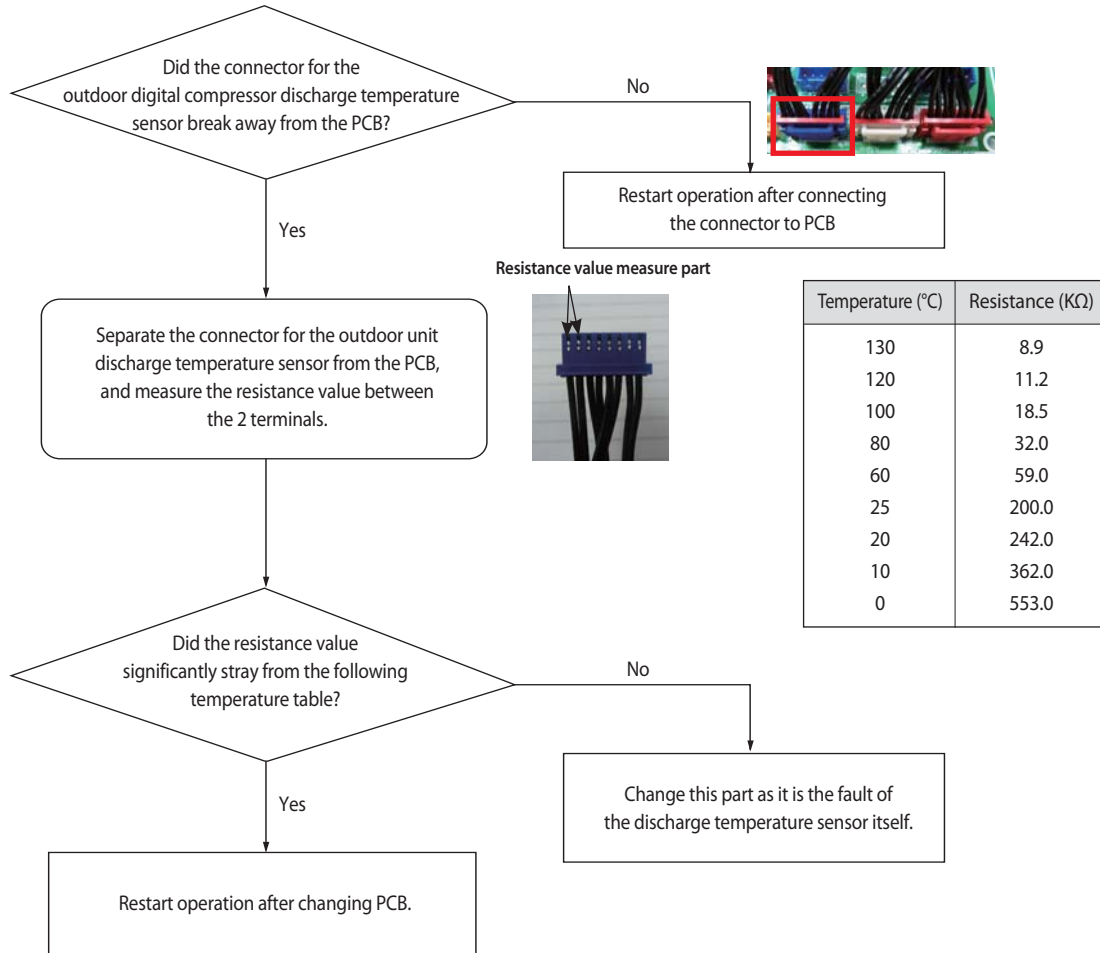

4-4-42 Constant Rate Compressor Discharge Temperature Sensor Error (OPEN/SHORT)

Outdoor Unit Display	E257, E258 (Compressor 2, Compressor 3)
Indoor Unit Display	●(Operation) ×(Reservation) ●(Blast) ×(Filter) ×(Defrost)
Judgment Method	• Refer to the inspection method below.
Special Cause	• Constant rate compressor discharge temperature sensor OPEN/SHORT problem

1. Inspection Method

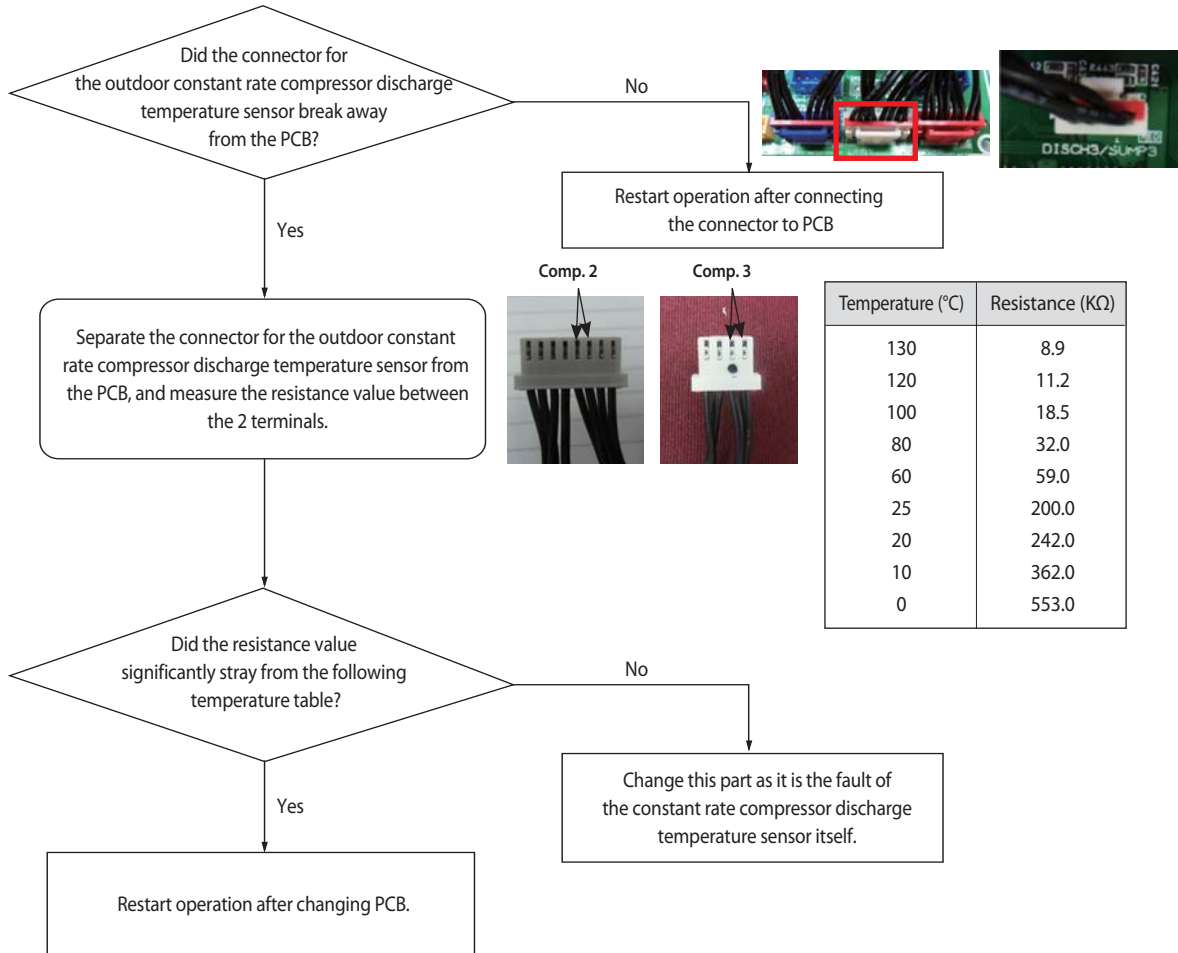

4-4-43 Compressor Discharge or Top 1/2 Temperature sensor error

Outdoor unit display	<i>E262</i> (Compressor 1 Discharge) <i>E263</i> (Compressor 2 Discharge) <i>E266</i> (Compressor 1 Top) <i>E267</i> (Compressor 2 Top)
Indoorunit display	● (Operation) ×(Reservation) ● (Blast) ×(Filter) ×(Defrost)
Judgment Method	· Refer to the judgment method below.
Cause of problem	· Compressor Discharge or Top Temperature sensor defective. (Open/Short)

1. Cause of problem

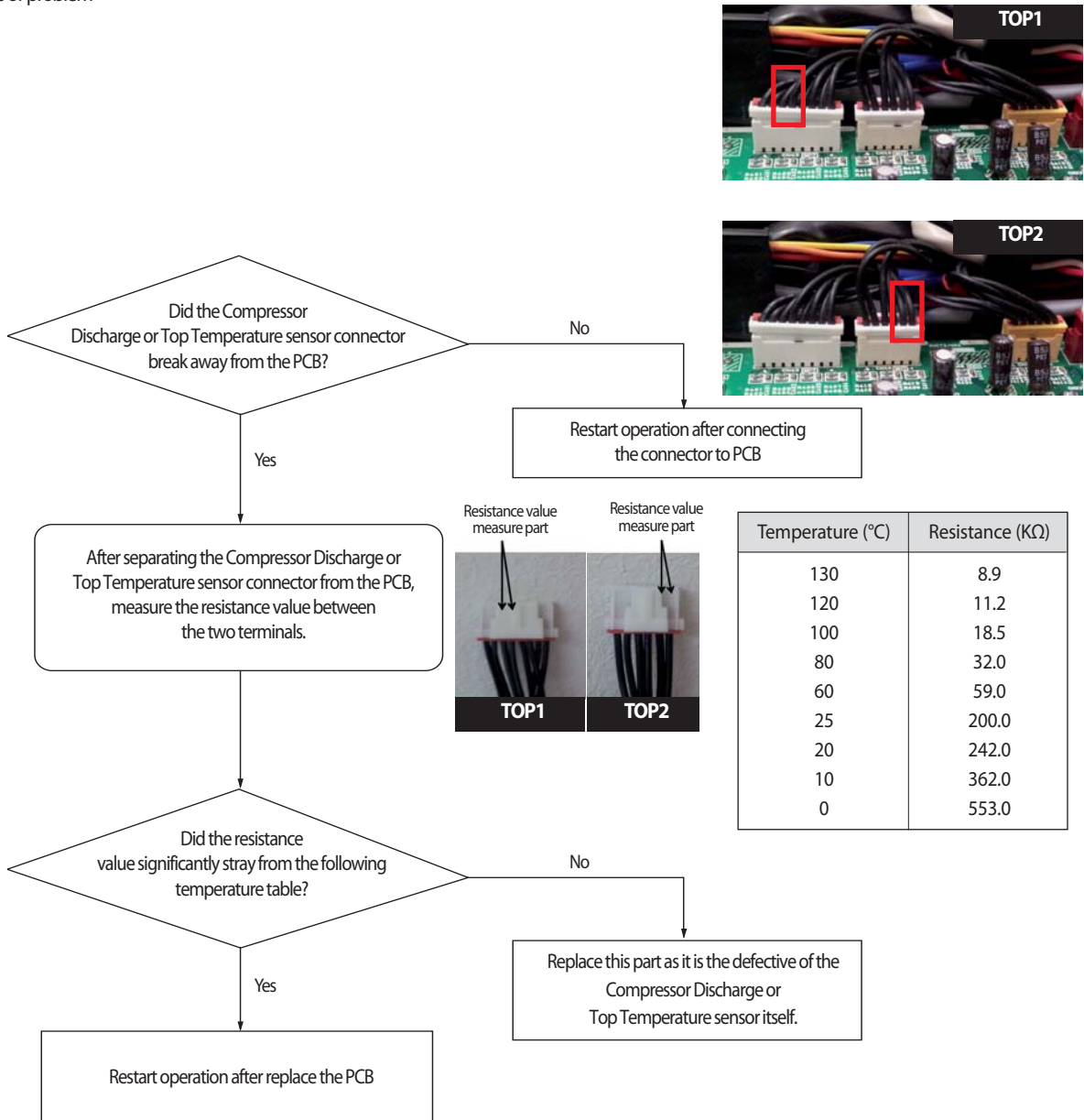

4-4-44 *E265* : Dislocation error of Compressor SUMP Temperature (oil temperature) Sensor

Outdoor unit display	<i>E265</i> (digital compressor or fixed compressor 1)
Indoor unit display	×(Operation) ●(Timer) ●(Fan) ●(Filter) ×(Defrost)
Criteria	• Refer to how to determine below
Cause of problem	• Sump (oil) temperature sensor dislocation error

1. How to diagnose

- 1) If the Sump temperature right before the start of compressor = $T_{\text{sump.ini}}$, current compressor's SUMP temp = $T_{\text{sump.real}}$,
 When the difference between $T_{\text{sump.ini}}$ and $T_{\text{sump.real}}$ is an absolute value so that it cannot be more than 2°C,
 In other words, the condition of $T_{\text{sump.real}} - T_{\text{sump.ini}} < 2^{\circ}\text{C}$ has been satisfied for 60 minutes since a compressor started, it is diagnosed as an error.
 After 60 minutes of compressor operation, there will be no Sump sensor dislocation detection.

2. How to check

- 1) Check if a sensor of the relevant compressor has been dislocated in accordance with error code, assemble and correct the error.

4-4-45 E269 : Suction Temperature sensor breakaway error

Outdoor unit display	E269
Indoorunit display	×(Operation) ●(Reservation) ●(Blast) ●(Filter) ×(Defrost)
Judgment Method	· If the suction temperature right before operating the Comp, when the operating order is highest, is set at $T_{suc, ini}$, and the suction temperature of the current Comp is set at $T_{suc, real}$, it is considered to have an error if the condition of $T_{suc, real} < T_{suc, ini} < 2^{\circ}C$ is maintained for 30 minutes.
Cause of problem	· Suction temperature sensor breakaway/defective.

1. Cause of problem

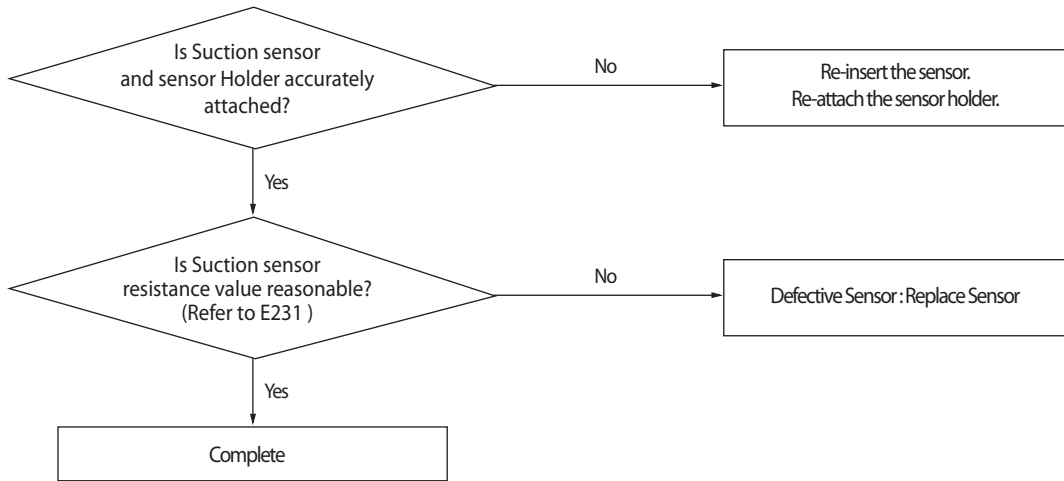

4-4-46 SUMP Temperature Sensor Error (OPEN/SHORT)

Outdoor Unit Display	E271
Indoor Unit Display	●(Operation) ×(Reservation) ●(Blast) ×(Filter) ×(Defrost)
Judgment Method	• Refer to the judgment method below.
Special Cause	• Disconnection or breakdown of relevant sensor

1. Inspection Method

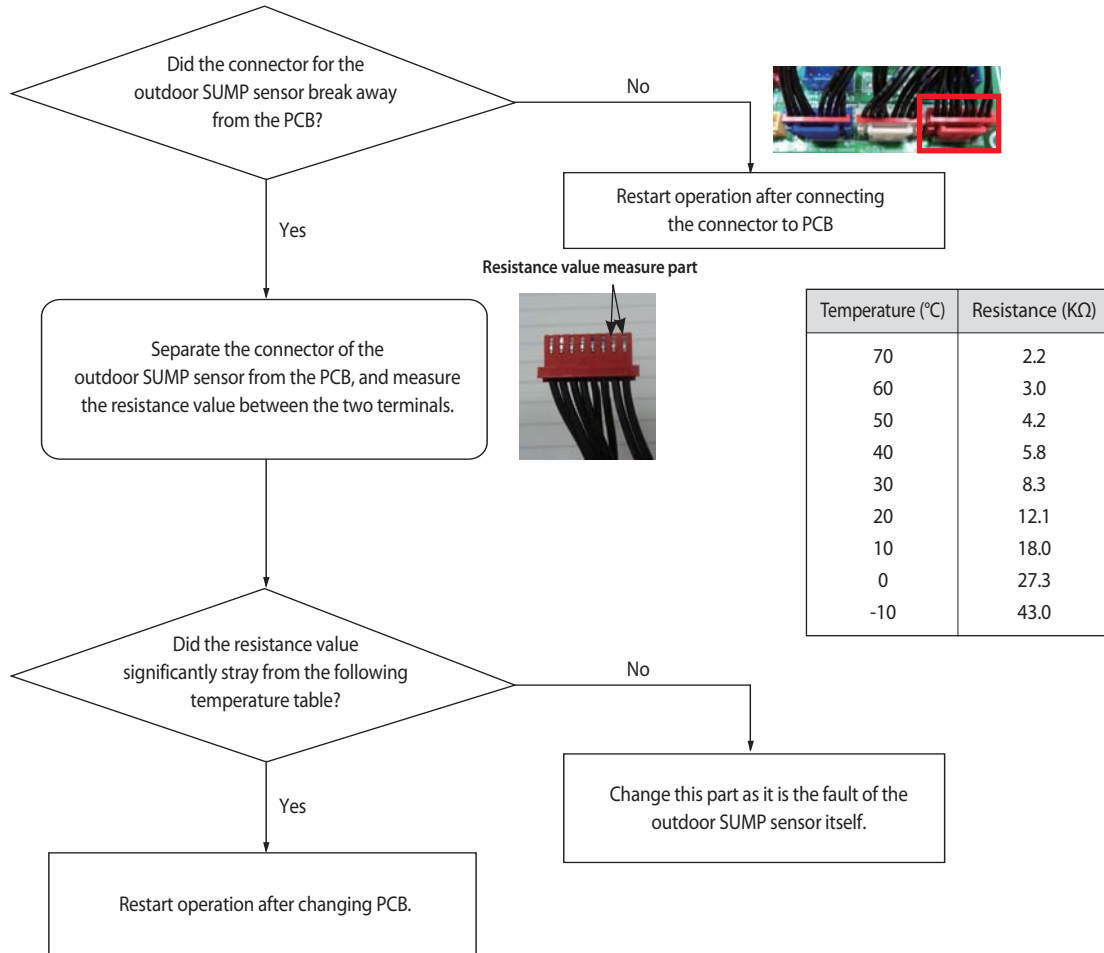

4-4-47 High Pressure sensor error (Open/Short)

Outdoor unit display	E291
Indoorunit display	×(Operation) ●(Reservation) ●(Blast) ●(Filter) ×(Defrost)
Judgment Method	· Refer to the judgment method below.
Cause of problem	· Disconnection or breakdown of relevant sensor.

1. High Pressure sensor Open/Short error determination method
 - 1) Identifies from when power is supplied or 2 minutes after RESET, and only when set is stopped.
 - 2) An Open/Short error will occur if the input voltage standard range of 0.5V ~ 4.95V is exceeded.

2. Inspection Method

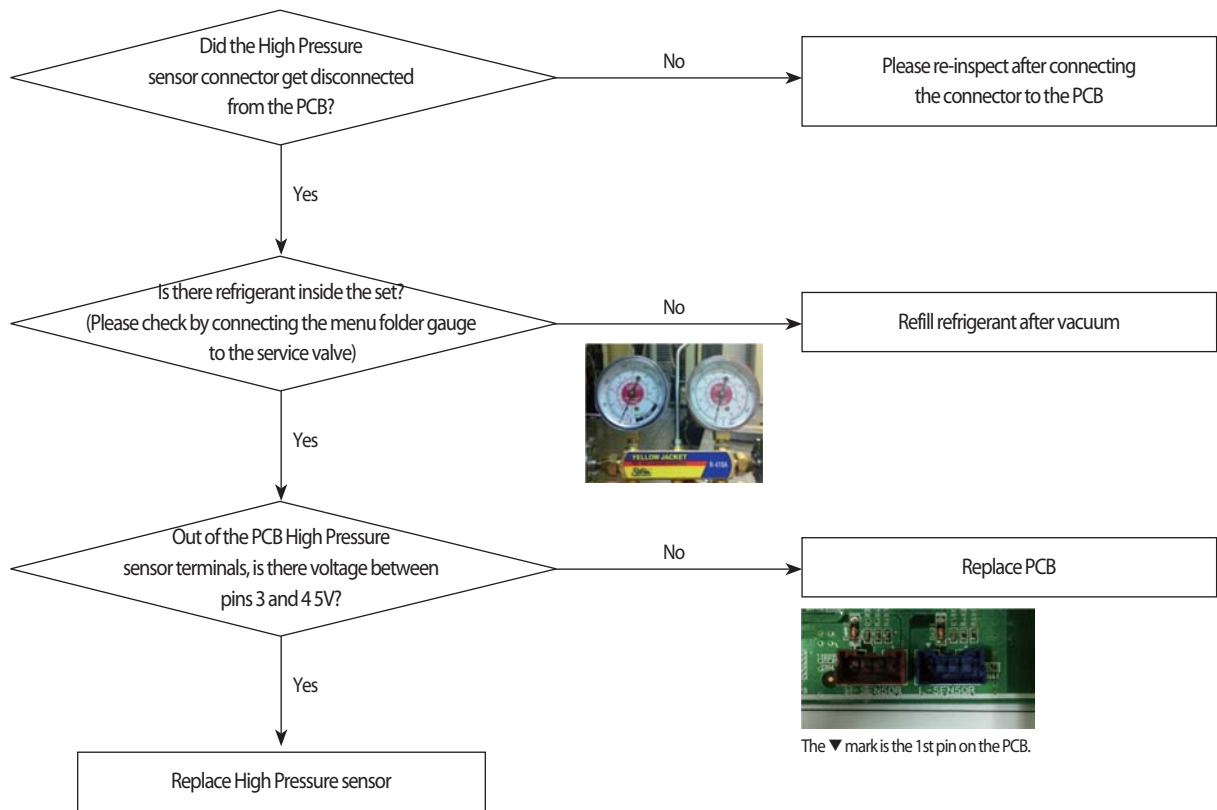

4-4-48 Low Pressure sensor error (Open/Short)

Outdoor unit display	E296
Indoorunit display	● (Operation) ● (Reservation) ● (Blast) ×(Filter) ×(Defrost)
Judgment Method	· Refer to the judgment method below.
Cause of problem	· Disconnection or breakdown of relevant sensor.

1. Low Pressure sensor Open/Short error determination method

- 1) Identifies from when power is supplied or 2 minutes after RESET, and only when set is stopped.
- 2) An Open/Short error will occur if the input voltage standard range of 0.5V ~ 4.95V is exceeded.

2. Inspection Method

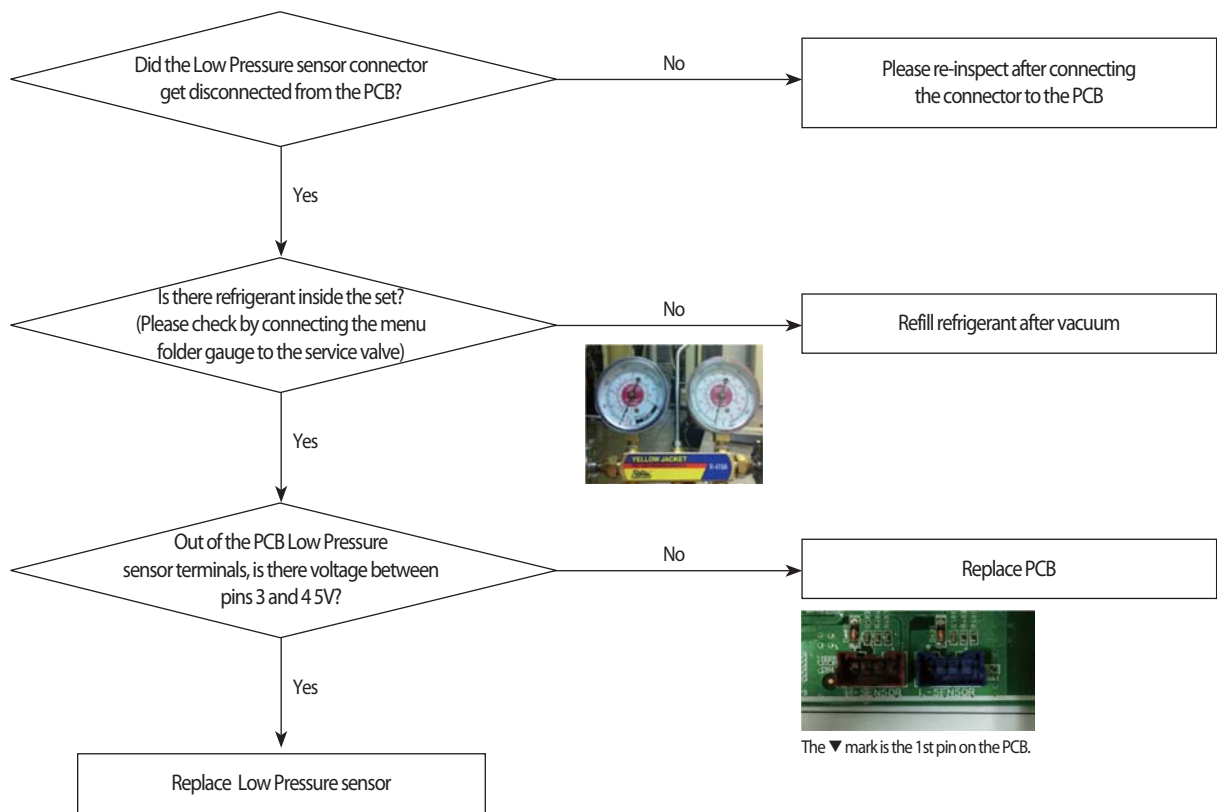

4-4-49 Suction Temperature sensor error (Open/Short)

Outdoor unit display	E308
Indoorunit display	● (Operation) ×(Reservation) ● (Blast) ×(Filter) ×(Defrost)
Judgment Method	· Refer to the judgment method below.
Cause of problem	· Disconnection or breakdown of relevant sensor.

1. Cause of problem

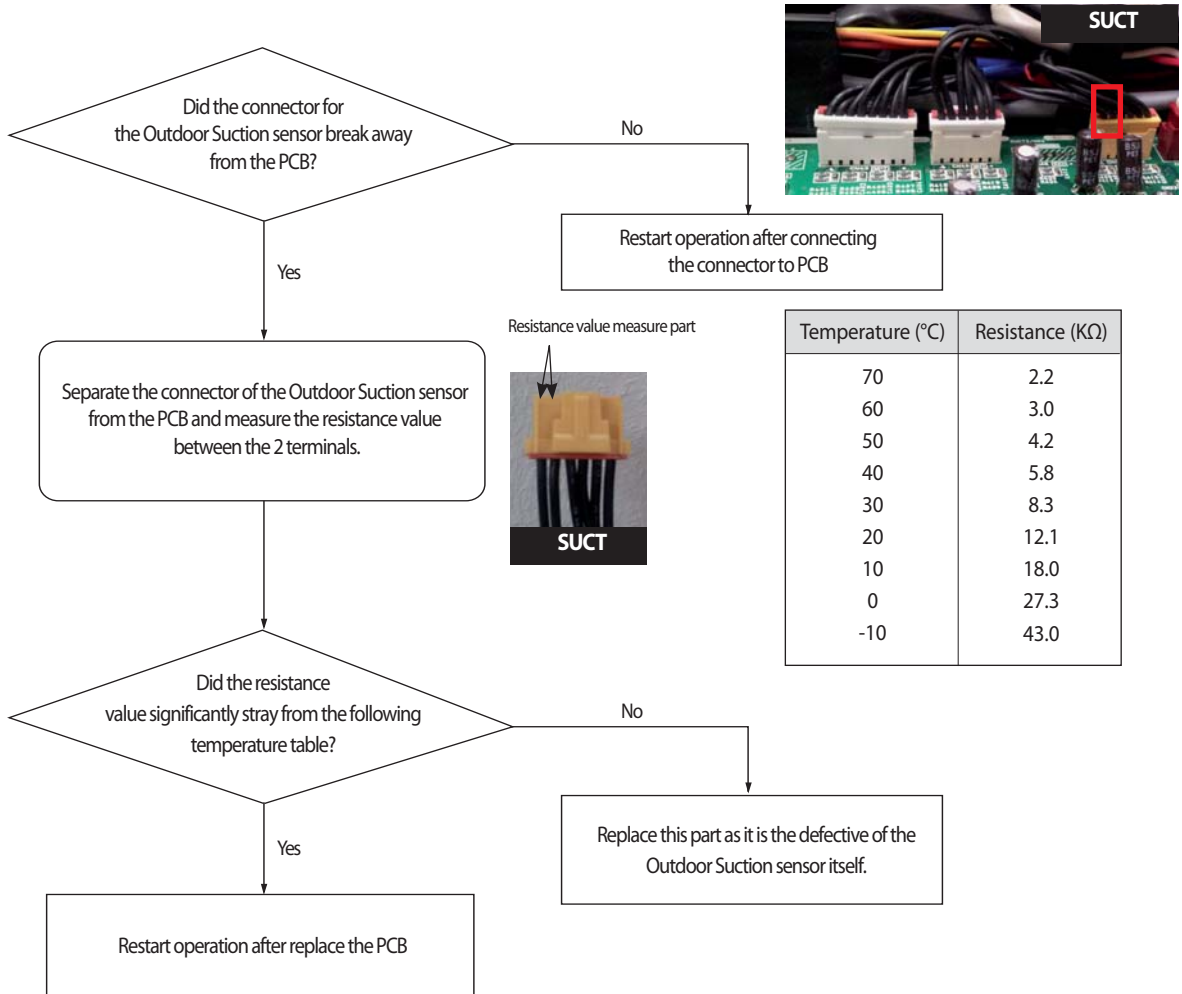

4-4-50 Liquid Pipe Temperature sensor error (Open/Short)

Outdoor unit display	E311
Indoorunit display	● (Operation) ×(Reservation) ● (Blast) ×(Filter) ×(Defrost)
Judgment Method	· Refer to the judgment method below.
Cause of problem	· Disconnection or breakdown of relevant sensor.

1. Cause of problem

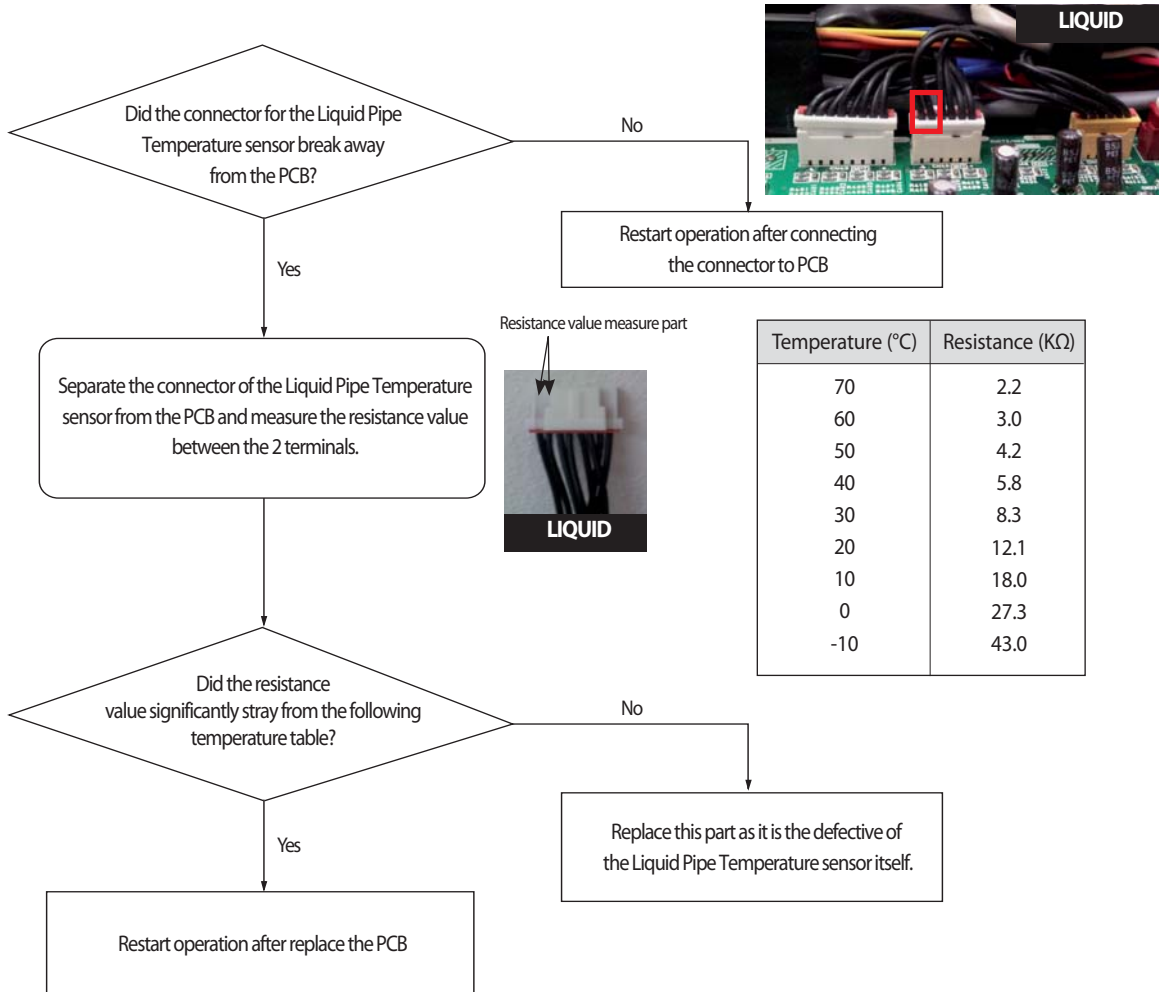

4-4-51 EVI In Temperature sensor error (Open/Short)

Outdoor unit display	E321
Indoorunit display	● (Operation) ×(Reservation) ● (Blast) ×(Filter) ×(Defrost)
Judgment Method	· Refer to the judgment method below.
Cause of problem	· Disconnection or breakdown of relevant sensor.

1. Cause of problem

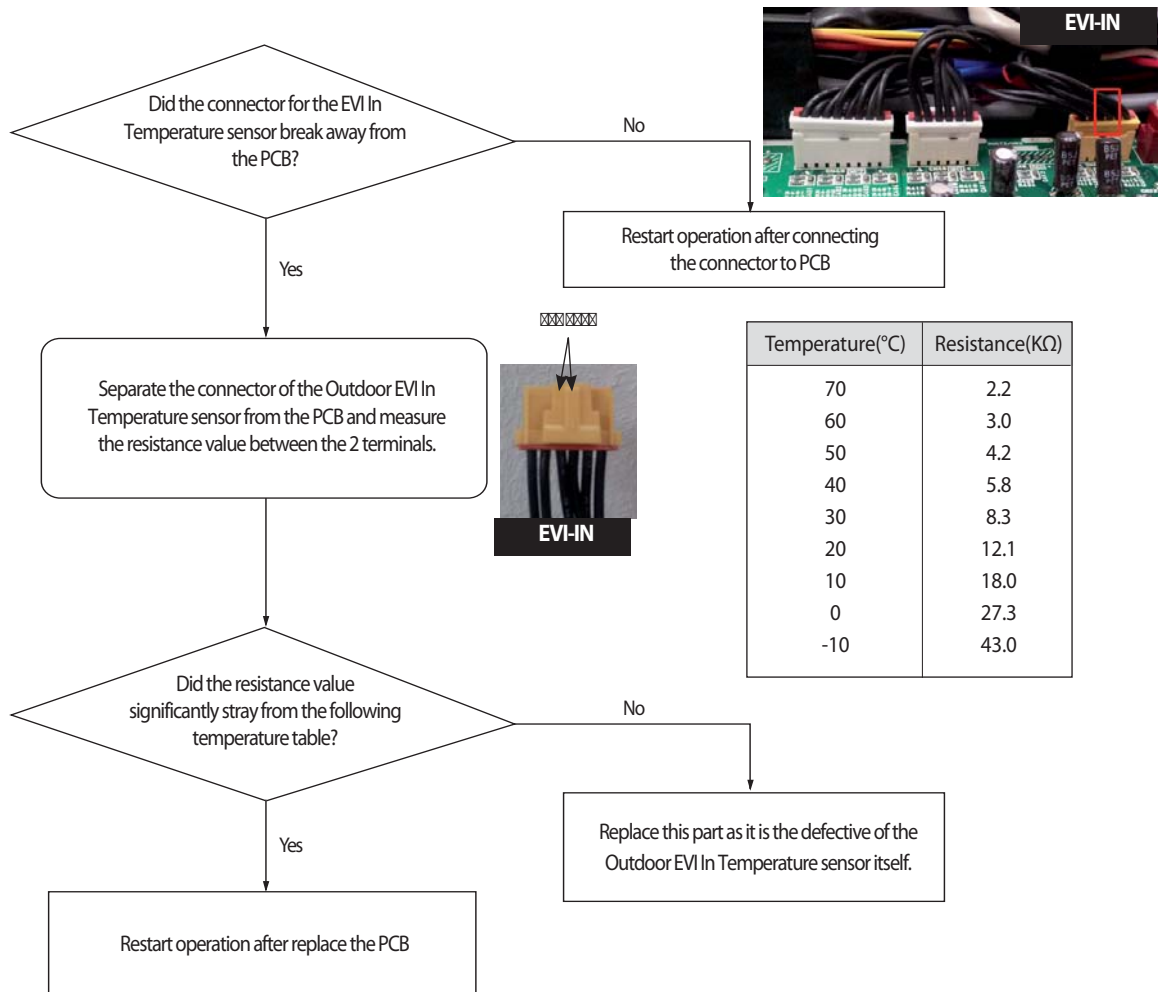

4-4-52 EVI Out Temperature sensor error (Open/Short)

Outdoor unit display	E322
Indoorunit display	● (Operation) ×(Reservation) ● (Blast) ×(Filter) ×(Defrost)
Judgment Method	· Refer to the judgment method below.
Cause of problem	· Disconnection or breakdown of relevant sensor.

1. Cause of problem

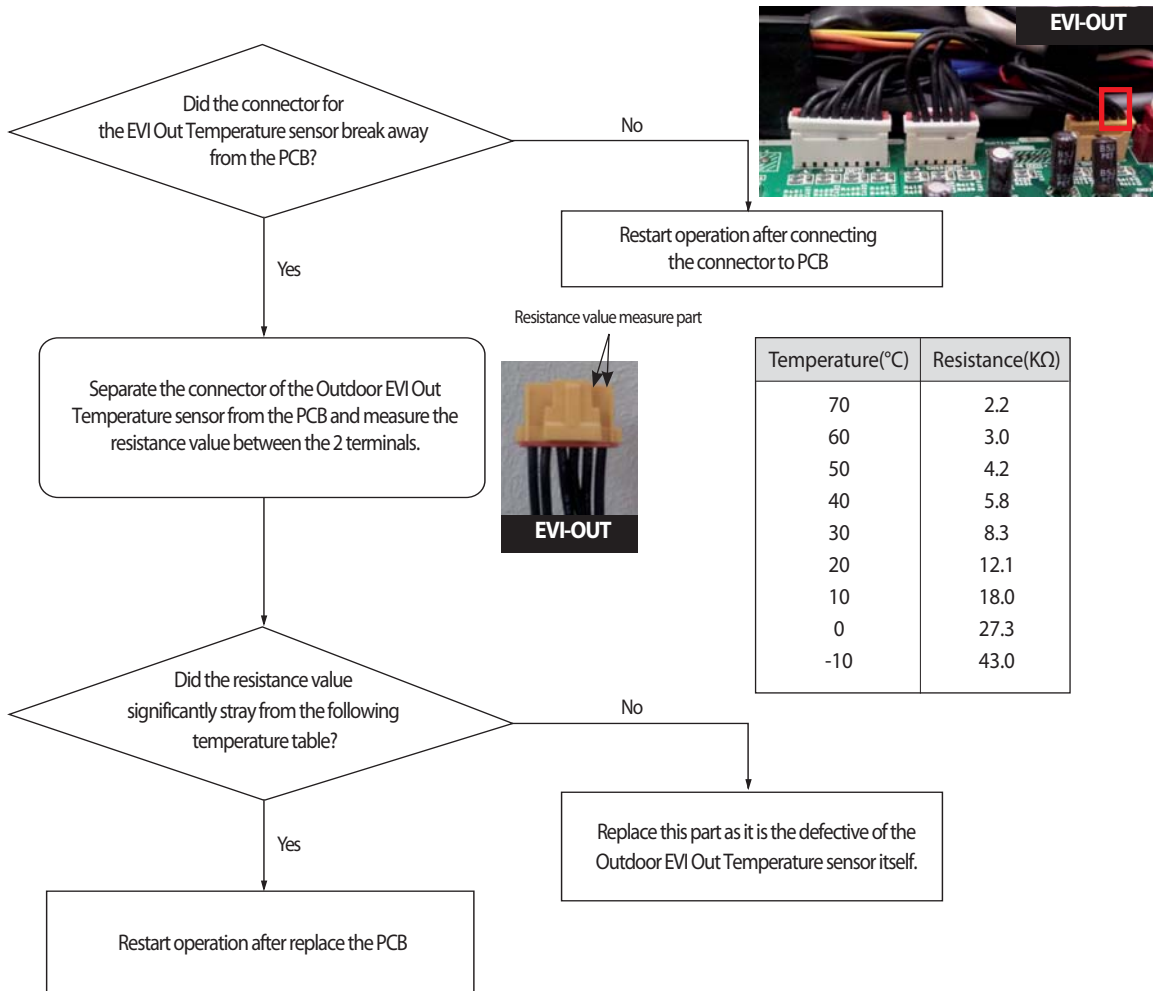

4-4-53 Suction-2 Temperature Sensor Error (OPEN/SHORT)

Outdoor Unit Display	E323
Indoor Unit Display	●(Operation) ×(Reservation) ●(Blast) ×(Filter) ×(Defrost)
Judgment Method	• Refer to the judgment method below.
Special Cause	• Disconnection or breakdown of relevant sensor

1. Inspection Method

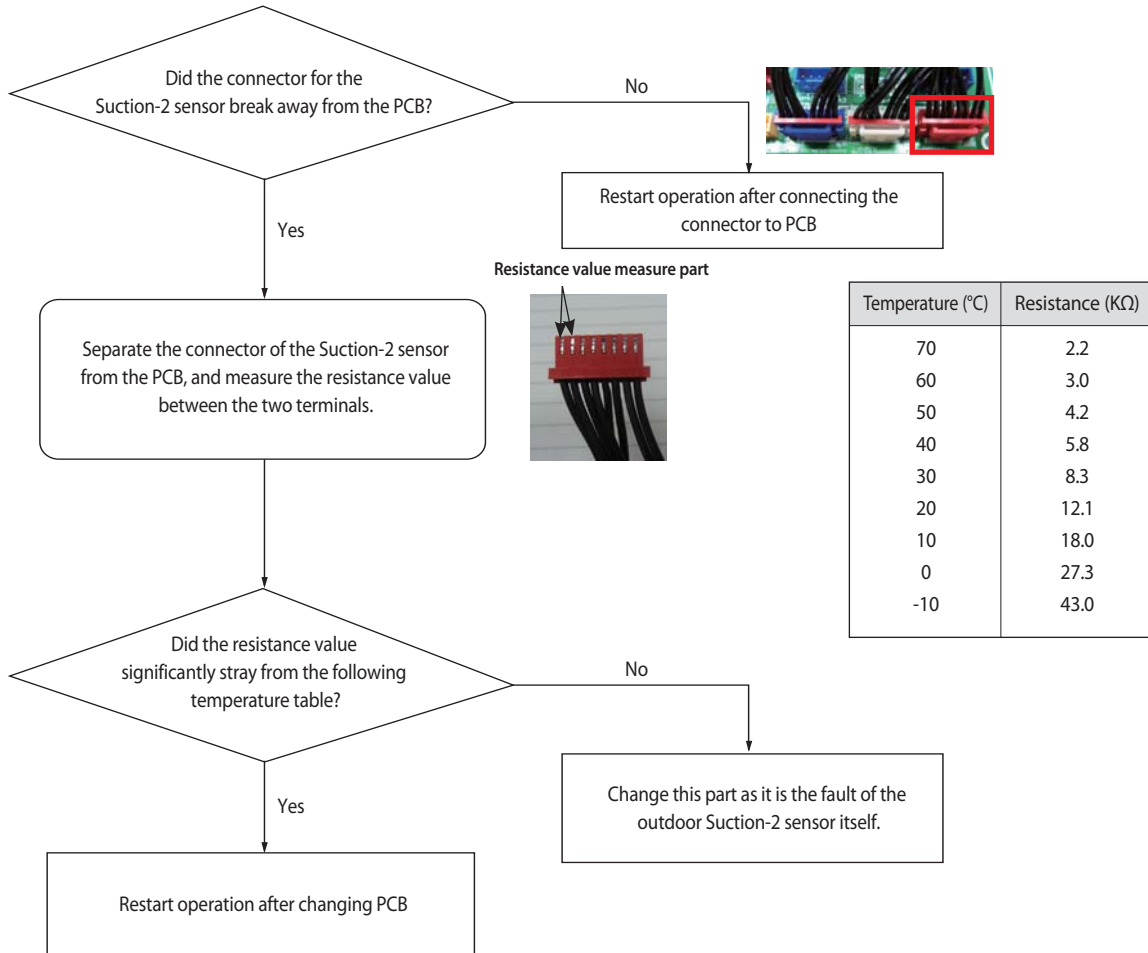

4-4-54 E407 : Comp. Down due to High Pressure Protection Control

Outdoor unit display	E407
Indoorunit display	×(Operation) ●(Reservation) ●(Blast) ●(Filter) ×(Defrost)
Judgment Method	Value of the high pressure sensor is detected at 40kg/cm² or more
Cause of problem	<p><Cooling Operation></p> <ul style="list-style-type: none"> · Outdoor unit fan motor problem (constrained, defective) · Motor driver defective or wire is cut · Outdoor heat exchanger is contaminated. · Service valve locked/Fill refrigerant <p><Heating Operation></p> <ul style="list-style-type: none"> · Outdoor unit fan motor problem (constrained, defective) · Motor driver defective or wire is cut · Service valve locked/Excessive refrigerant

1. Cause of problem

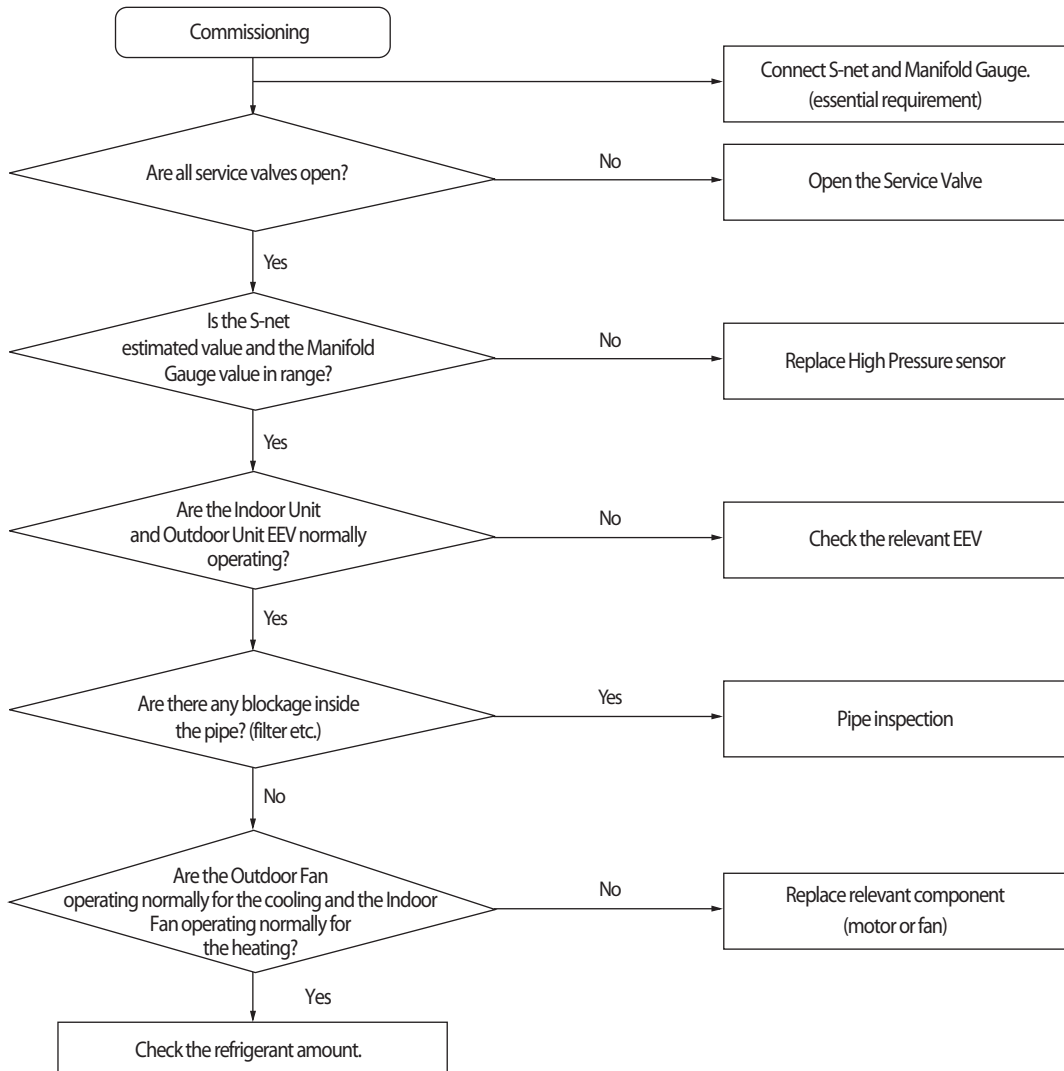

4-4-55 E4 10 : Comp. Down due to Low Pressure Protection Control

Outdoor unit display	E4 10
Indoorunit display	×(Operation) ●(Reservation) ●(Blast) ●(Filter) ×(Defrost)
Judgment Method	· Inspection when the value of low pressure sensor is 0.8kg/cm ² , or less for air conditioning and 0.6kg/cm ² for heating
Cause of problem	<ul style="list-style-type: none"> · Refrigerant shortage · Electronic expansion valve blocked · Service valve blocked · Low pressure sensor defective · Leakage of compressor discharge check valve of not-go-end outdoor unit · Error may be found when used in temperature range outside the conditions of use (Operating outside temperature at -20°C or less for heating and operating outside temperature at -5°C or less for Cooling)

1. Cause of problem

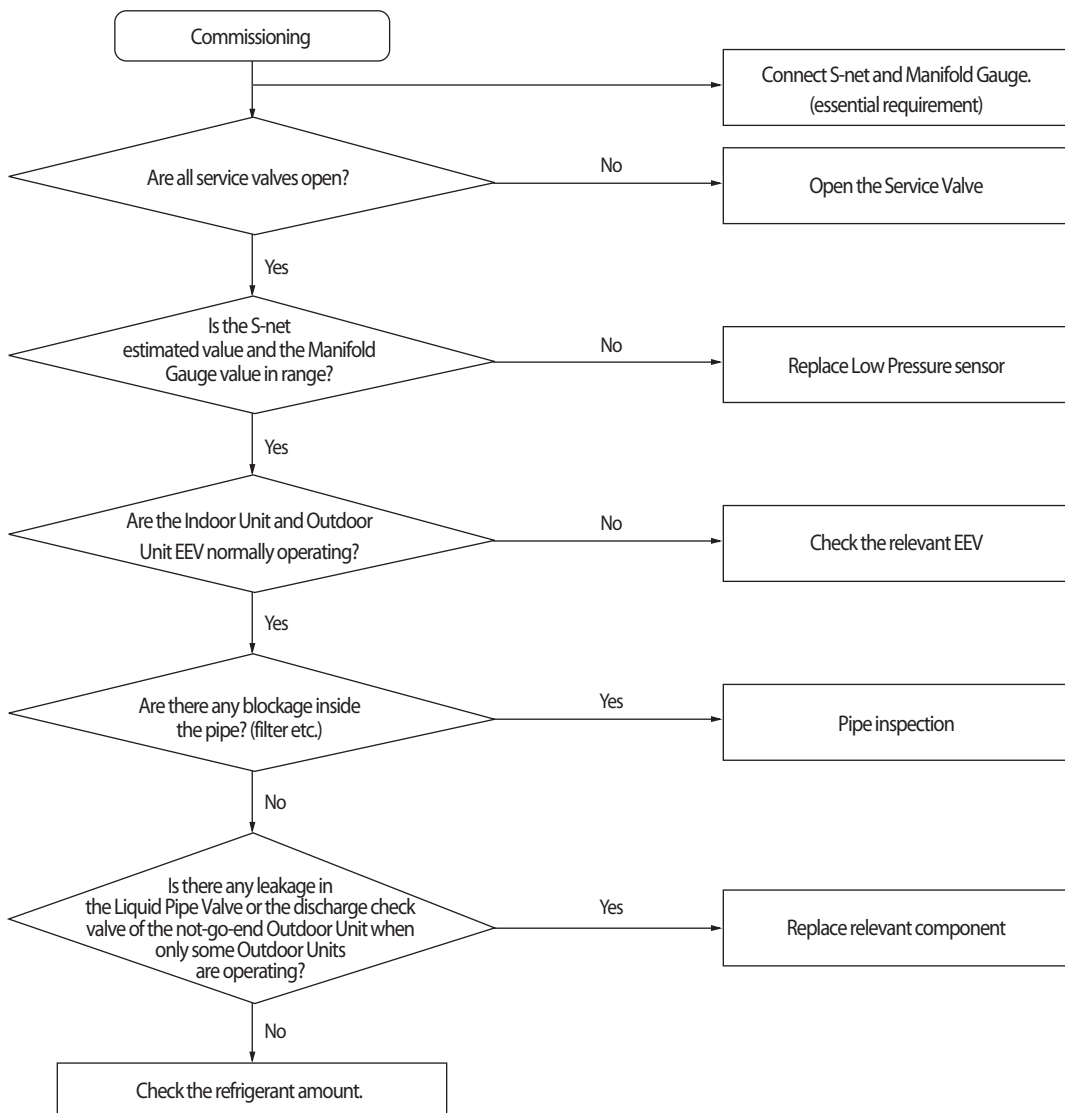

4-4-56 Sump Sensor Error Due to Protection Control

Outdoor Unit Display	E413
Indoor Unit Display	×(Operation) ●(Reservation) ●(Blast) ●(Filter) ×(Defrost)
Judgment Method	• Maintain sump temperature of 95°C or more for five minutes
Special Cause	• Compressor loading faulty/sump temperature sensor faulty

1. Inspection Method

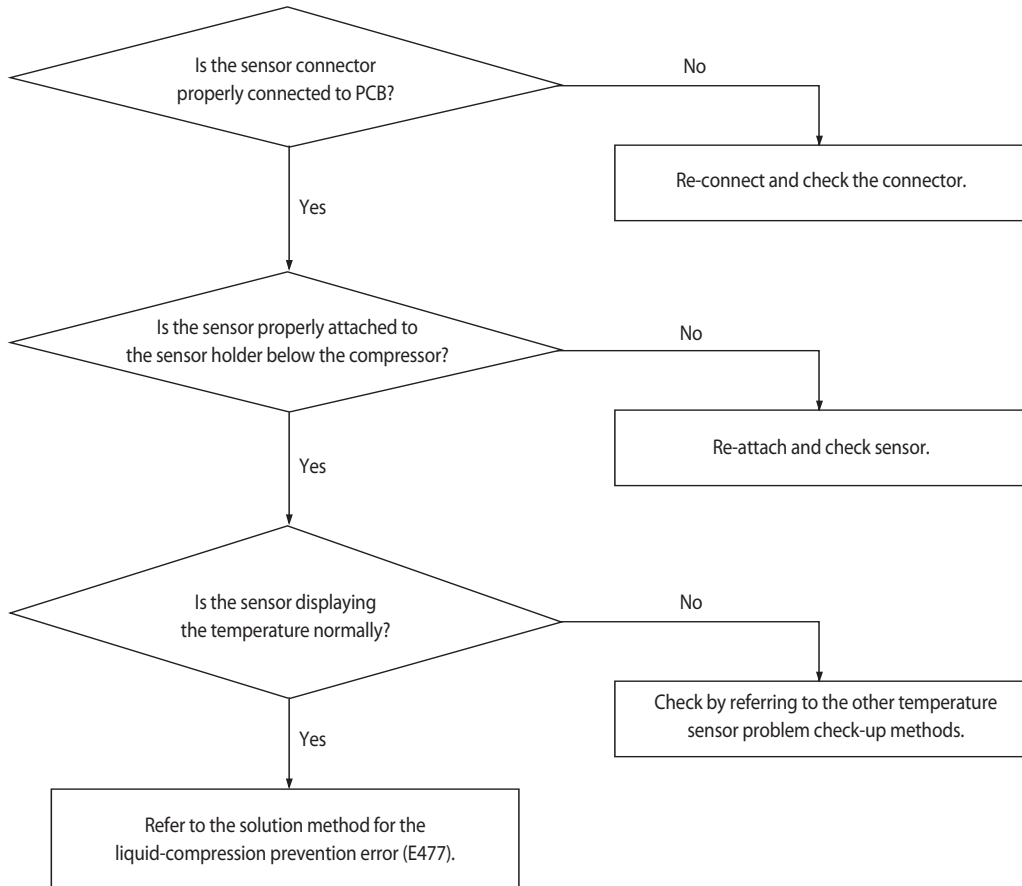

4-4-57 E4 16 : Comp. Down due to Compressor Discharge Temperature sensor

Outdoor unit display	E4 16
Indoorunit display	×(Operation) ●(Reservation) ●(Blast) ●(Filter) ×(Defrost)
Judgment Method	· When value of compressor discharge temperature sensor is checked at 120°C or more
Cause of problem	<ul style="list-style-type: none"> · Refrigerant shortage · Electronic expansion valve is blocked. · Service valve blocked · Defective discharge temperature sensor · Blocked pipe and defective · Leakage of compressor discharge check valve of not-go-end outdoor unit

1. Cause of problem

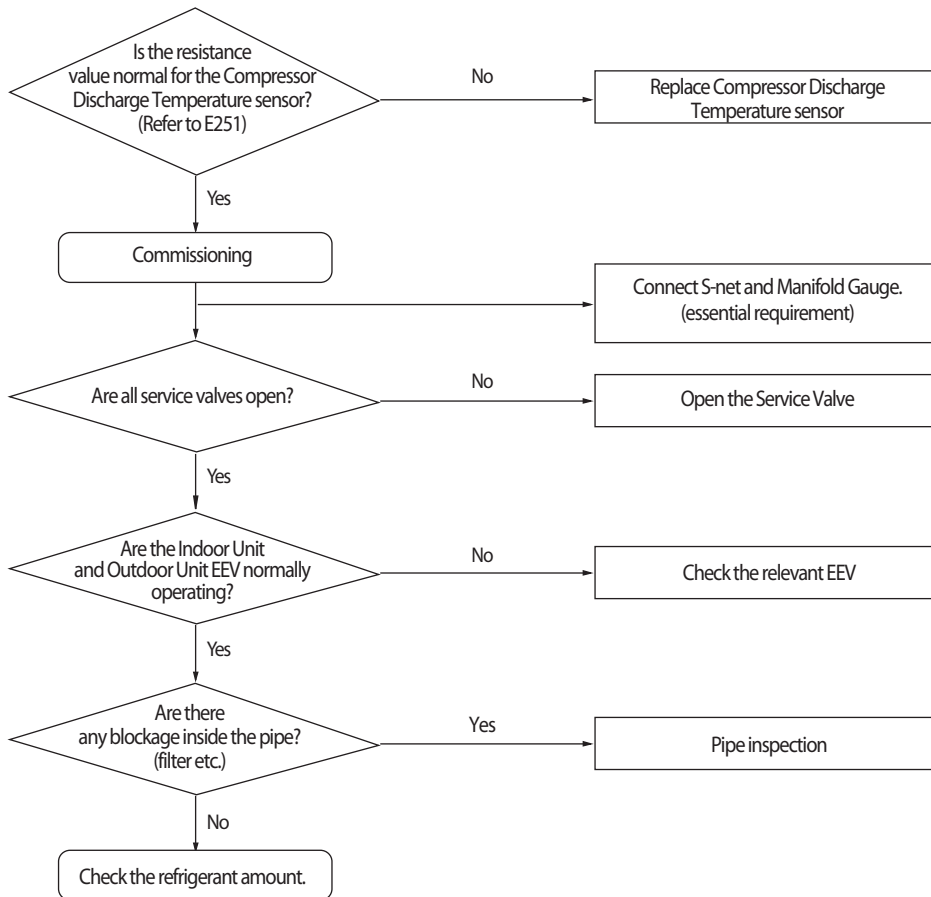

4-4-58 3-phase Input Wiring error

Outdoor unit display	E425
Indoorunit display	×(Operation) ● (Reservation) ● (Blast) ● (Filter) ×(Defrost)
Judgment Method	<ul style="list-style-type: none"> · When turn on the power and check the status of the power from the inverter. · If the phase does not connect the power(no phase) : E425 or E466 (E366) is displayed (Air conditioner to maintain the normal state.) · However) N-phase must be properly connected.
Cause of problem	<ul style="list-style-type: none"> · Check the input wiring · EMI Fuse short

1. Cause of problem

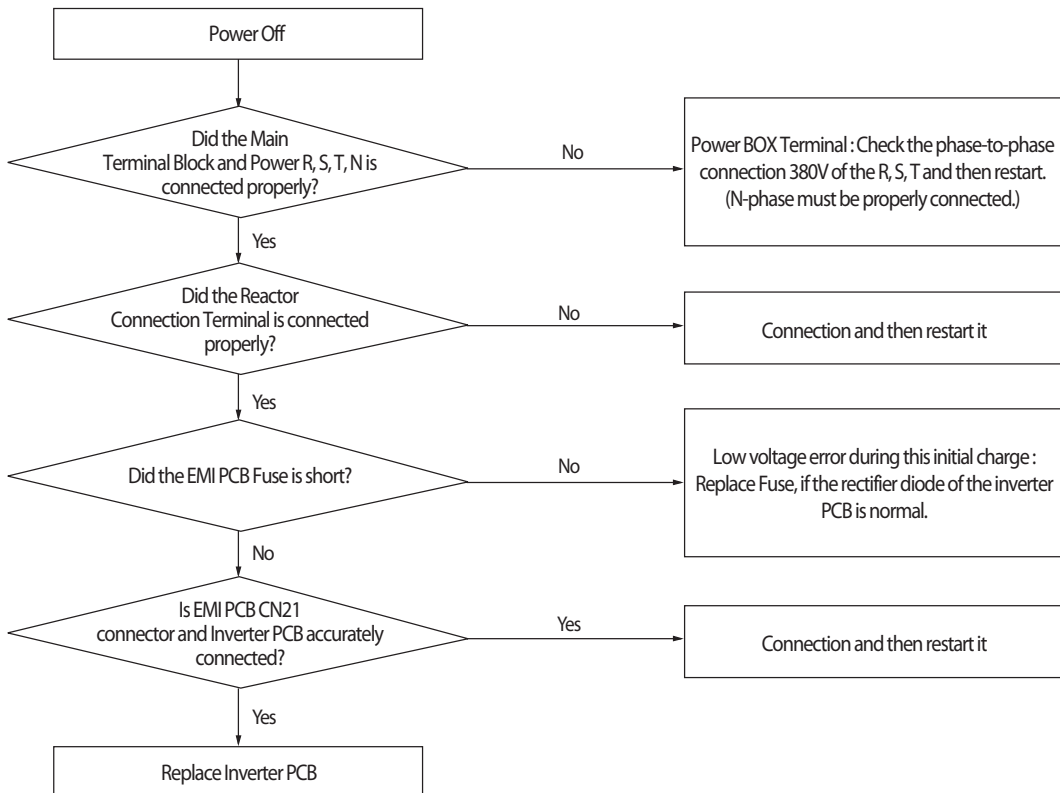

4-4-59 E428 : Comp. Down by Compression Ratio Control

Outdoor unit display	E428
Indoorunit display	×(Operation) ●(Reservation) ●(Blast) ●(Filter) ×(Defrost)
Judgment Method	<ul style="list-style-type: none"> · When compression ratio (high pressure+1)/(low pressure+1) less than 1.5 and lasts for 10 minutes or more · Differential pressure (high pressure - low pressure) less than 0.4 MPa.g and lasts for 10 minutes or more
Cause of problem	<ul style="list-style-type: none"> · Indoor and Outdoor EEV breakdown · 4Way Valve breakdown · High and Low pressure sensor defective · Refrigerant shortage

1. Cause of problem

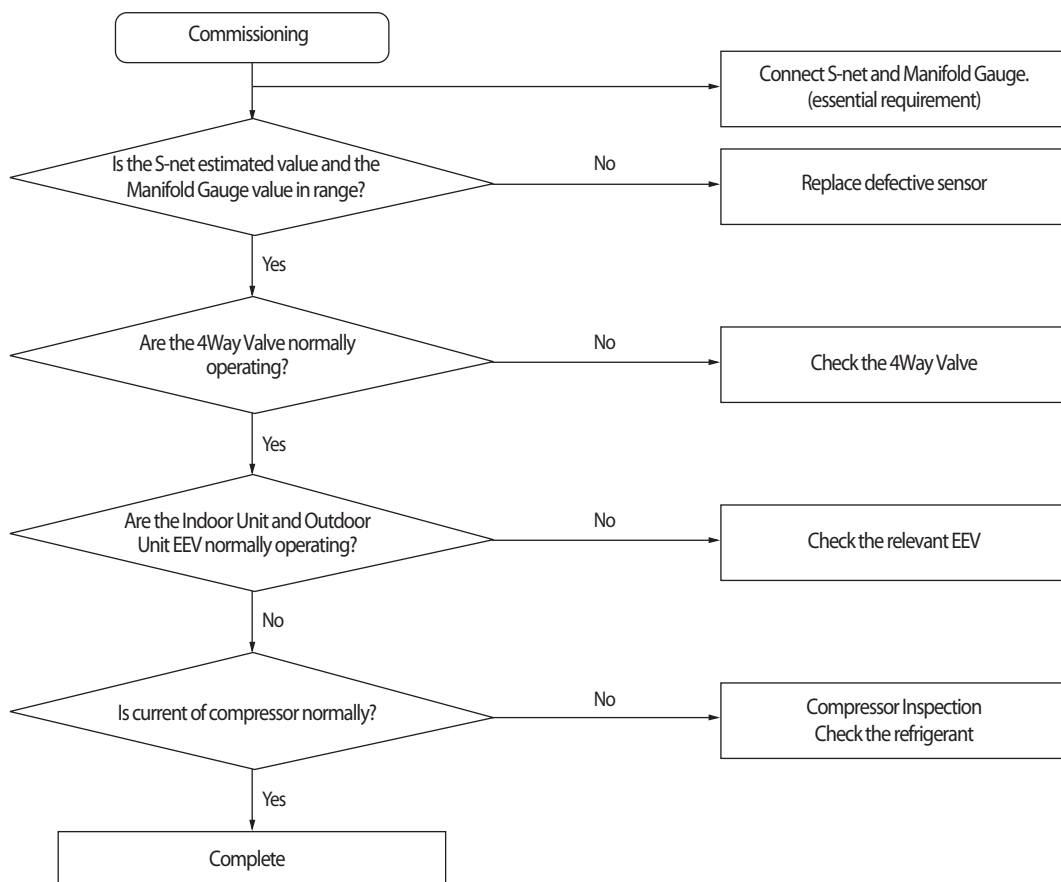

4-4-60 EVI EEV Open error

Outdoor unit display	E438
Indoorunit display	-
Judgment Method	. DSH <10 °C, EVI Out-in <= 0°C & frequency> 65Hz 40 minutes maintaining
Cause of problem	. EVI EEV and Intercooler leakage, excessive refrigerant amount, Outdoor Check Valve inserted opposite. . Indoor Unit EEV leakage, direct connection between Indoor Liquid Pipe and the Gas Pipe.

※ Indoor EEV leakage can be easily checked during the operation of cooling operation and during the not-go-end blast operation.
(In case it is normal, the EVA In and Out temperatures for the blast may rise.)

※ If cooling operation is operated for low temperature with excessive refrigerant amount, then the DSH may descend.

1. Cause of problem

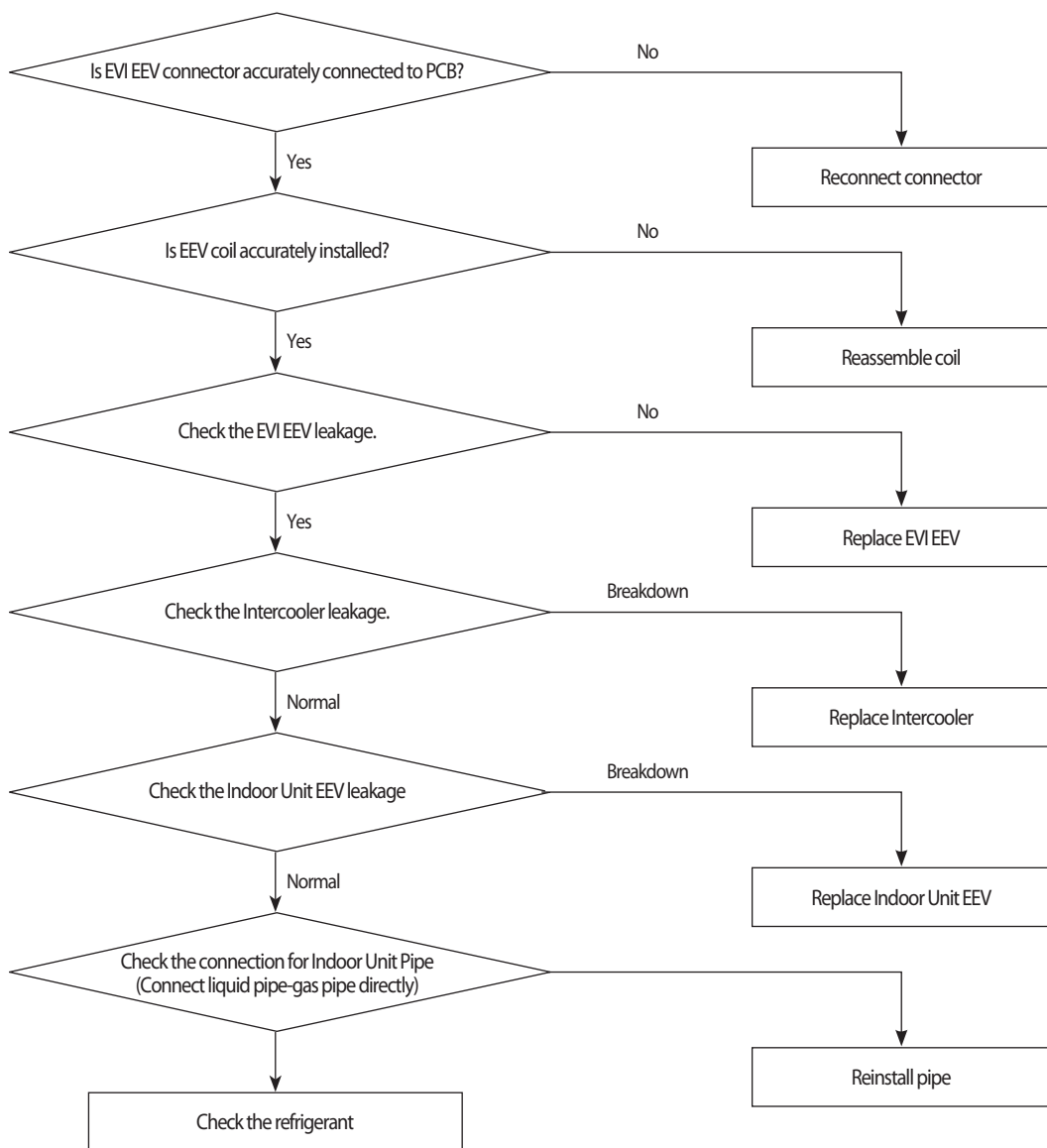

4-4-61 Refrigerant Leakage Error

Outdoor Unit Display	E439
Indoor Unit Display	×(Operation) ●(Reservation) ●(Blast) ●(Filter) ×(Defrost)
Judgment Method	• Refer to the judgment method below
Special Cause	• Leakage of refrigerant, simultaneous malfunction of pressure sensor

■ Low-pressure sensor OPEN/SHORT error determination method

1. Identifies from when power is supplied or 2 minutes after RESET, and only when set is stopped.
2. An E439 error will occur if the input voltage standard ranges of 0.5V ~ 4.95V of both the high- and low-pressure sensors are exceeded.
3. Will occur if the measured value of both high- and low-pressure sensors is 1kgf/cm²G

1. Inspection method

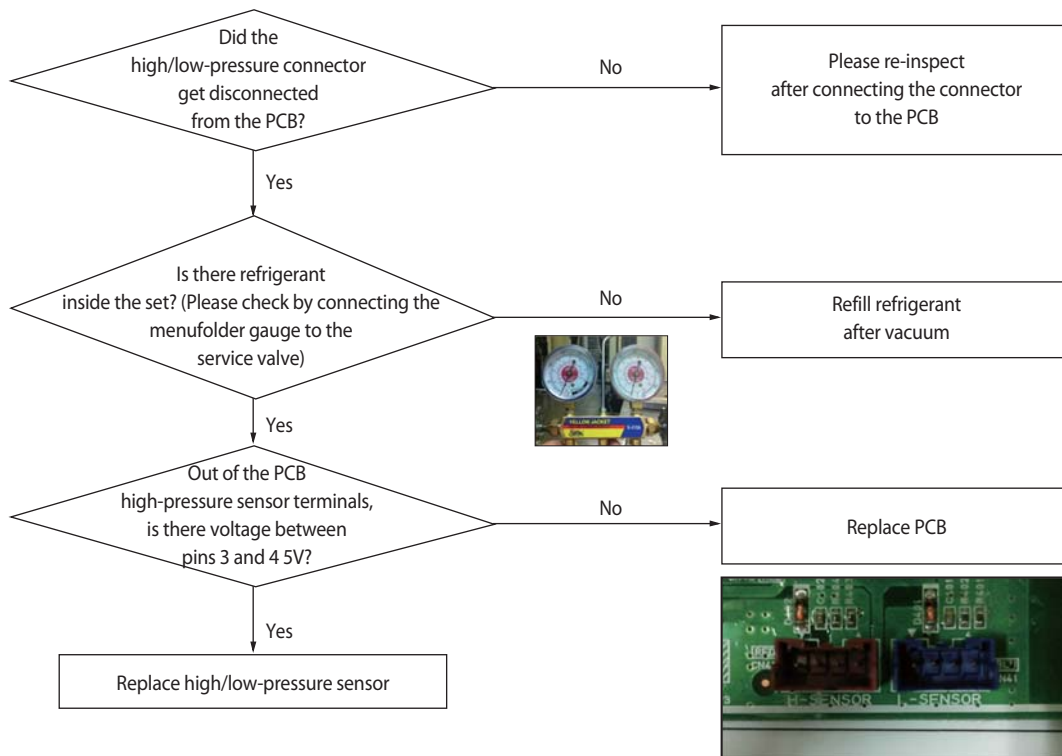

The ▼ mark is the 1st pin on the PCB.

4-4-62 E440, E442 : Prohibition of the operation of Compressor due to Outdoor Temperature

Outdoor unit display	<i>E440</i> (prohibit heating operation in outdoor temperature over 30°C) <i>E442</i> (prohibit heat filling operation in outdoor temperature over 15°C)
Indoor unit display	No sign
Criteria	<i>E440</i> : Right before an outdoor unit starts heating operation by On signal of an indoor Remocon, the error occurs and prohibits the operation in outdoor temperature over 30°C <i>E442</i> : Right before operating heat refrigerant filling mode by the K1 switch of an outdoor PCB, the error occurs and prohibits the operation in outdoor temperature over 15°C
Cause of problem	• Operation Prohibition mode by the indoor temperature limit

1. How to check

The above error code is not caused by a product's problem but a function to protect the product by limiting the available temperature range so please refer to the usable temperature range in the product manual.

If the error code is displayed despite a condition that does not belong to any of the above diagnosis methods, read the temperature sensor value of the outdoor inlet air with View Mode or S-net, and if the actual outdoor temperature is different, please replace the temperature sensor.

4-4-63 High Pressure Standard Not Met before Air Conditioning (Inability to Re-operate)

Outdoor unit display	E443
Indoorunit display	×(Operation) ● (Reservation) ● (Blast) ● (Filter) ×(Defrost)
Judgment Method	· Operation should be forbidden if High Pressure sensor value of the Main Unit before the pump down is started at 2.2kg/cm ² g or below for air-conditioning and 1.0kg/cm ² G or less for heating for three consecutive seconds. (Restarting operation is not possible, and an error displayed on the indoor unit.)
Cause of problem	· Refrigerant leakage/fault in High Pressure sensor .

1. Cause of problem

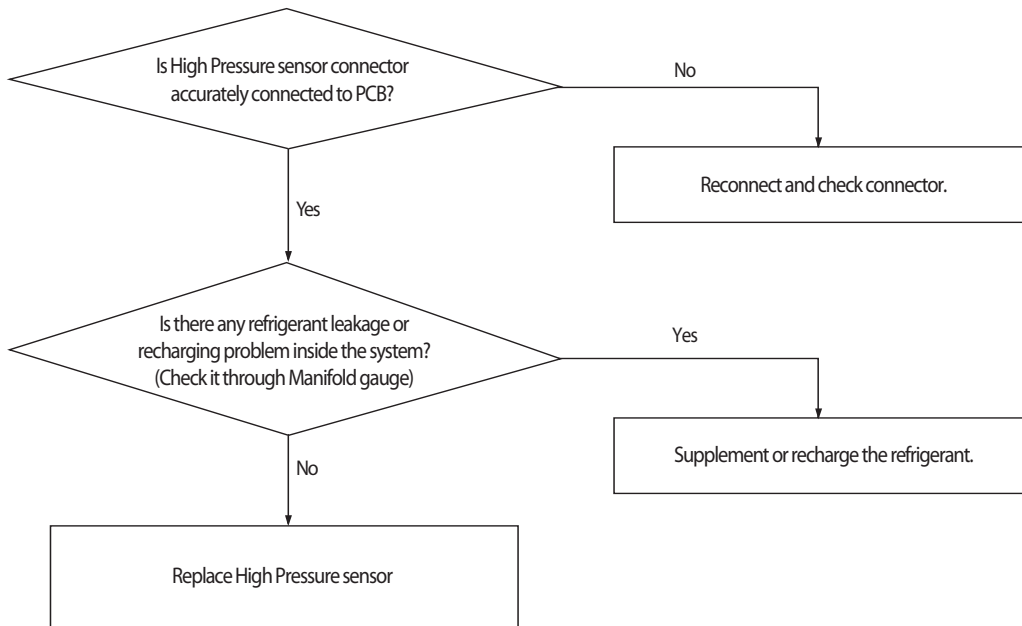

4-4-64 CCH Malfunction and Sump Sensor Miswiring Error

Outdoor Unit Display	E445
Indoor Unit Display	-
Judgment Method	• Refer to the judgment method below
Special Cause	• CCH Connector PCB is not connected / Sump sensor compressor separated / Own problem of CCH

1. Judgment Method

Tini = Sump temperature when entering the CH operation delay condition

Tlast= Sump temperature when maintaining CH operation delay for two hours

Outside Air Temperature Sensor Value: Outside air temperature when maintaining CH operation delay for two hours

① $Tlast - Tini < 2^{\circ}\text{C}$

② $Tlast < \text{Outside Air Temperature Sensor Value} + 2^{\circ}\text{C}$

③ Outside Air Temperature Sensor Value $< 30^{\circ}\text{C}$

If ①, ② and ③ are satisfied at the same time, then display E445.

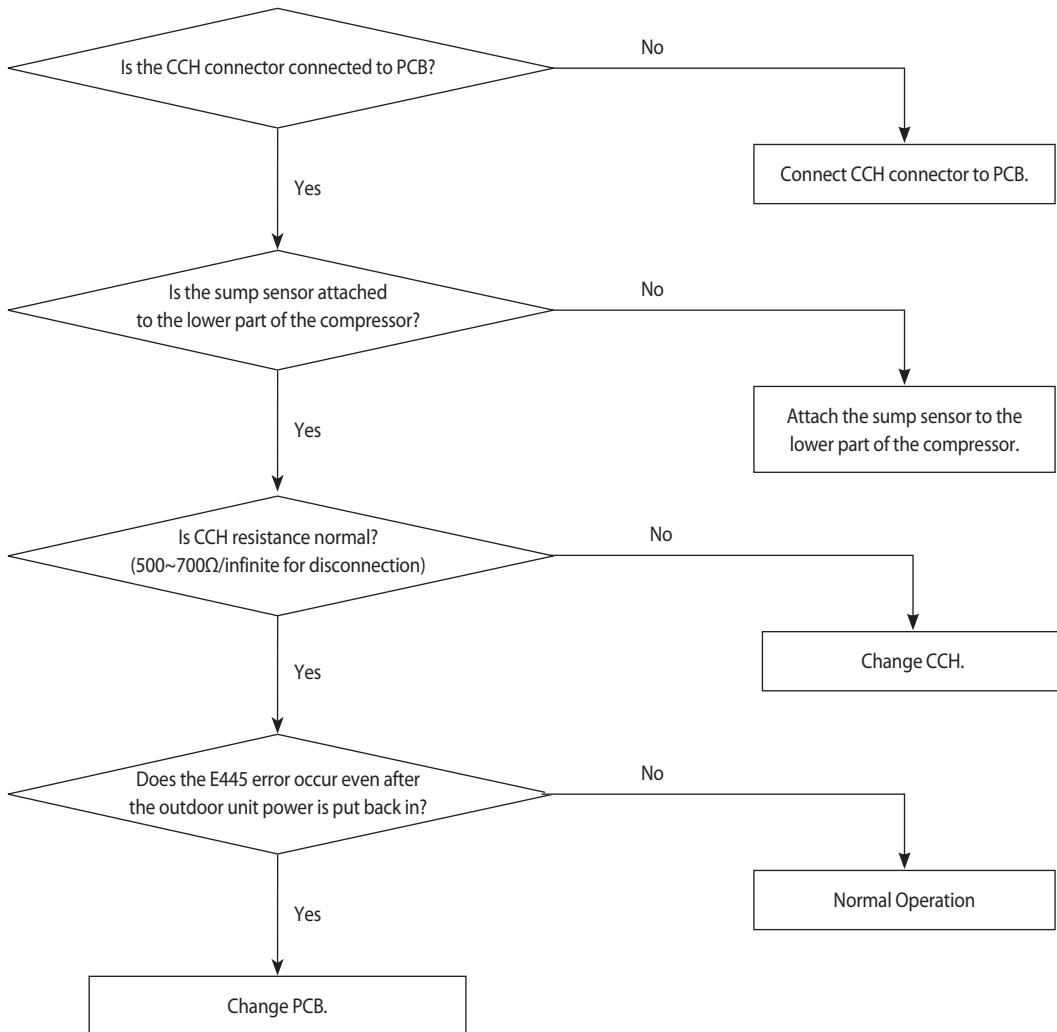

4-4-65 Fan starting error

Outdoor unit display	E446 (FAN PCB(FAN1)) E346 (FAN PCB(FAN2))
Judgment Method	<ul style="list-style-type: none"> · Startup, and then if the speed increase is not normally. · Detected by H/W or S/W
Cause of problem	<ul style="list-style-type: none"> · Compressor connection error · Defective Compressor · Defective PCB

1. Cause of problem

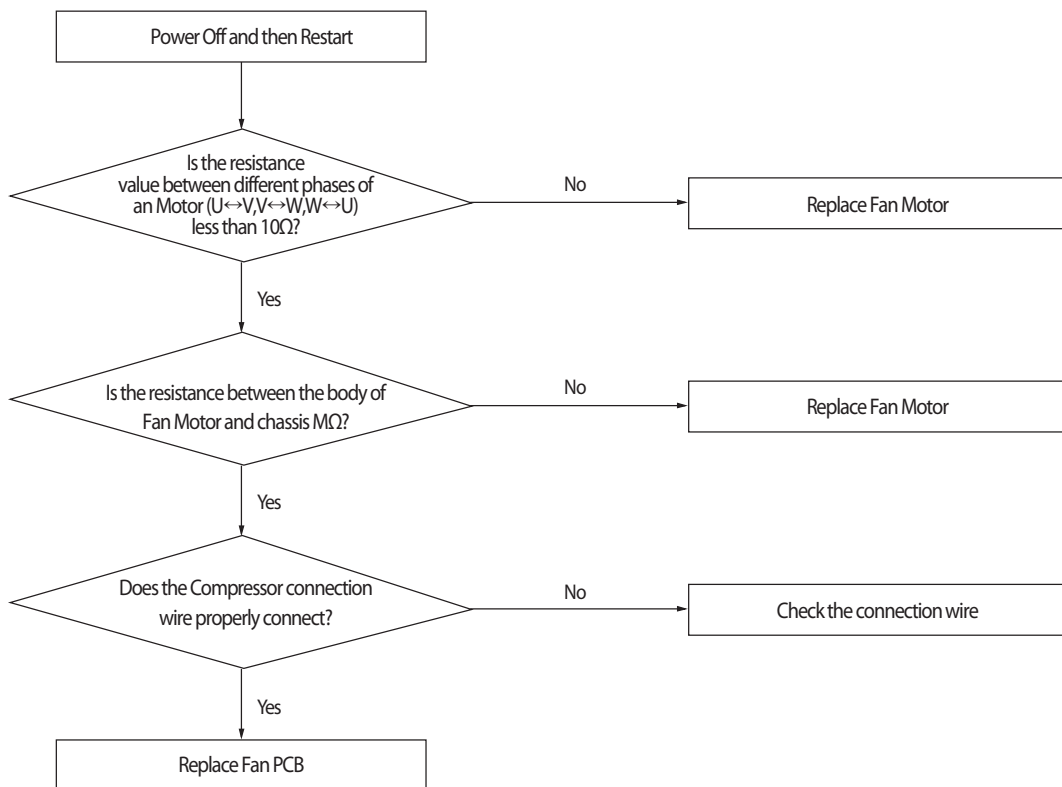

4-4-66 Fan lock error

Outdoor unit display	E448 (FAN PCB(FAN1)) E348 (FAN PCB(FAN2))
Judgment Method	· Is checked symptoms by phase current of Fan Motor.
Cause of problem	· Fan Motor connection error. · Defective Fan · Defective PCB

1. Cause of problem

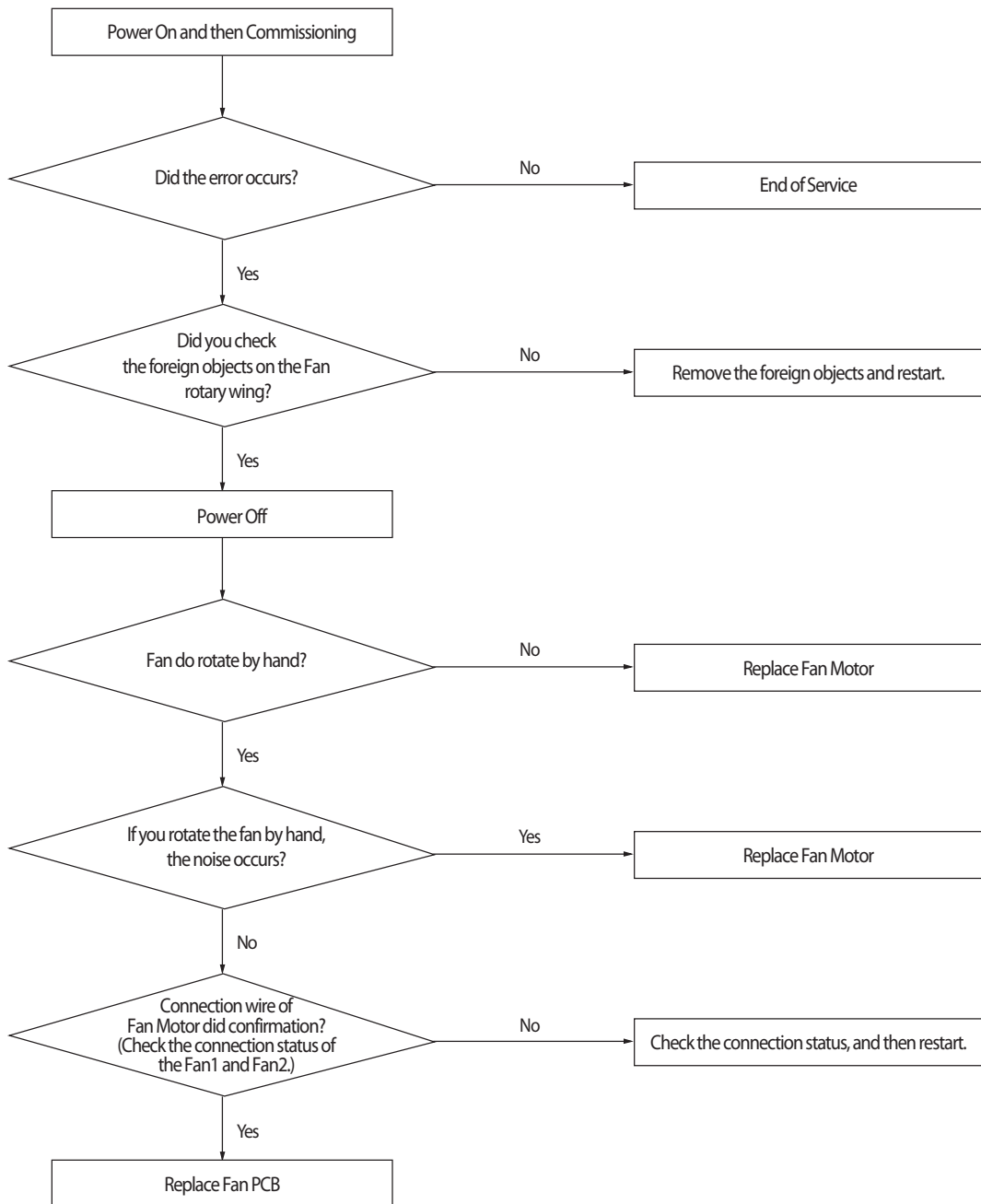

4-4-67 Momentary Blackout error

Outdoor unit display	E452
Indoorunit display	×(Operation) ●(Reservation) ●(Blast) ●(Filter) ×(Defrost)
Judgment Method	· Momentary stop of compressor due to momentary blackout.
Cause of problem	· Momentary stop of compressor due to momentary blackout.

1. Precautions : Replace Hub PCB or Main Hub Connection wire.

4-4-68 Outdoor Fan Motor overheating

Outdoor unit display	<i>E453</i> (FAN PCB(FAN1)) <i>E353</i> (FAN PCB(FAN2))
Judgment Method	· Overheating due to the internal sensor of the Fan Motor.
Cause of problem	· Defective connection wire · Defective Fan Motor · Defective PCB · Defective installation conditions

1. Cause of problem

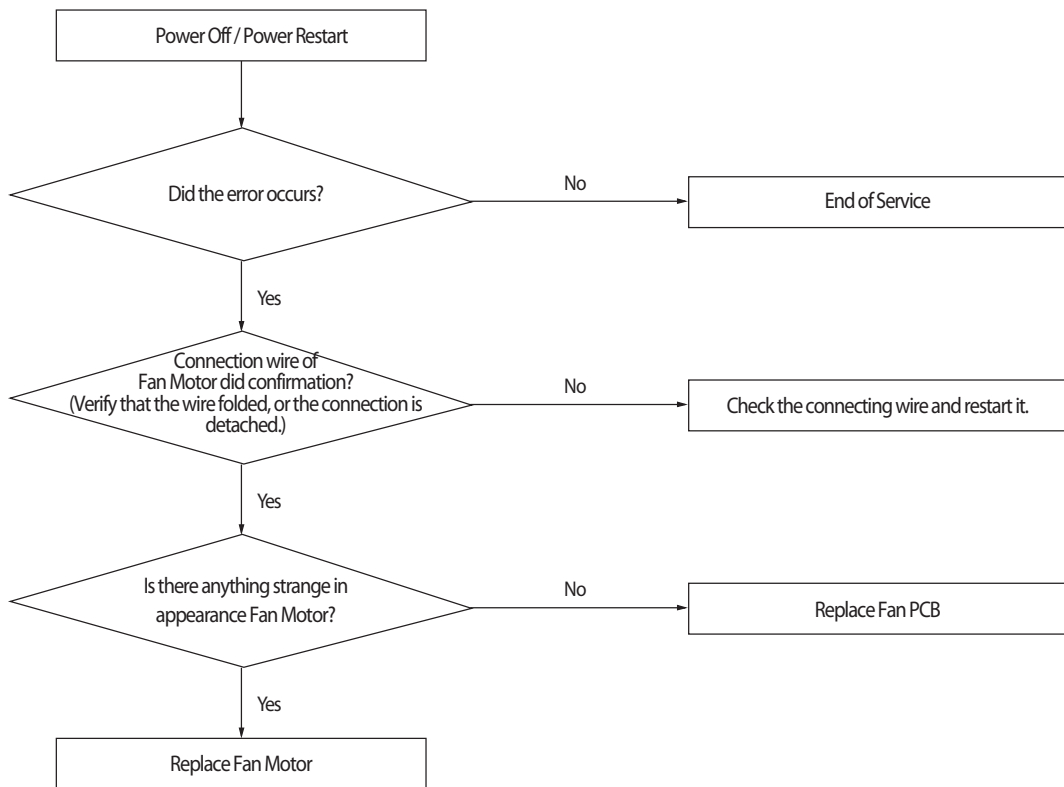

4-4-69 Outdoor Unit Fan Motor RPM Error

Outdoor Unit Display	E454
Indoor Unit Display	-
Judgment Method	• In case the number of the revolutions of the outdoor unit fan motor in motion is different by 100 rpm or more compared to the instructed value.
Special Cause	• Outdoor unit fan motor constrained or faulty of operation

1. Inspection Method

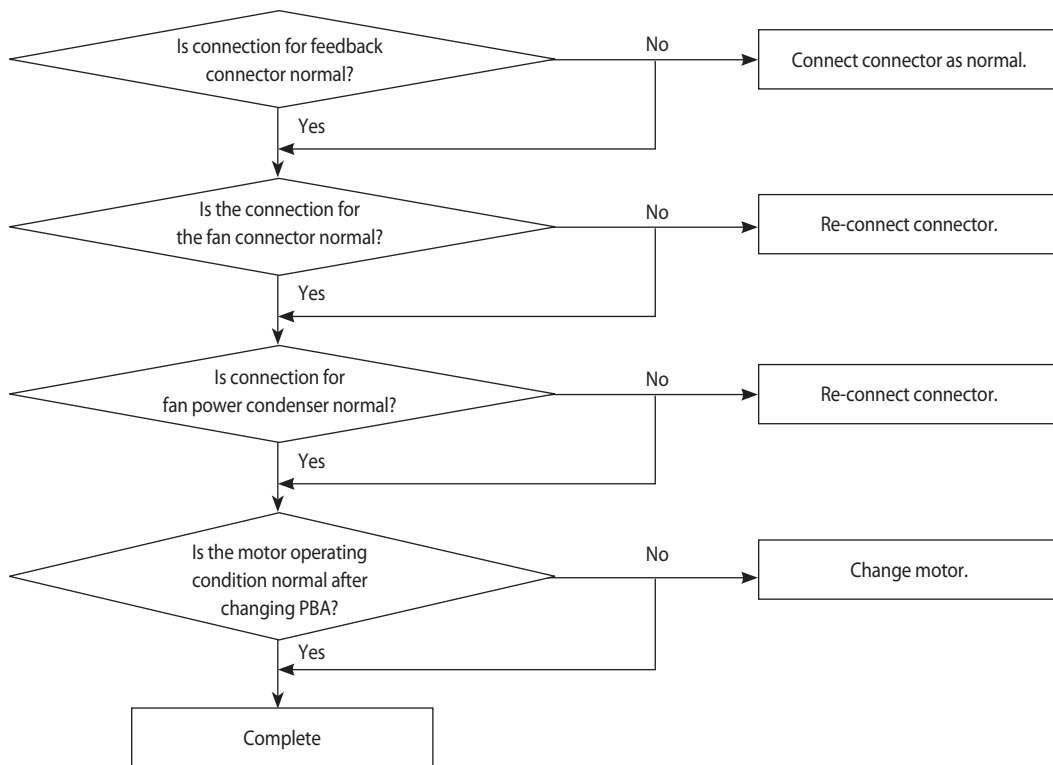

4-4-70 Fan IPM Overheat error

Outdoor unit display	<i>E455</i> (FAN1 PCB) <i>E355</i> (FAN2 PCB)
Judgment Method	· IPM internal temperature more than 85°C (E455, E355)
Cause of problem	· Heat sink and IPM assembly defective. · Defective heat sink cooling

1. Cause of problem

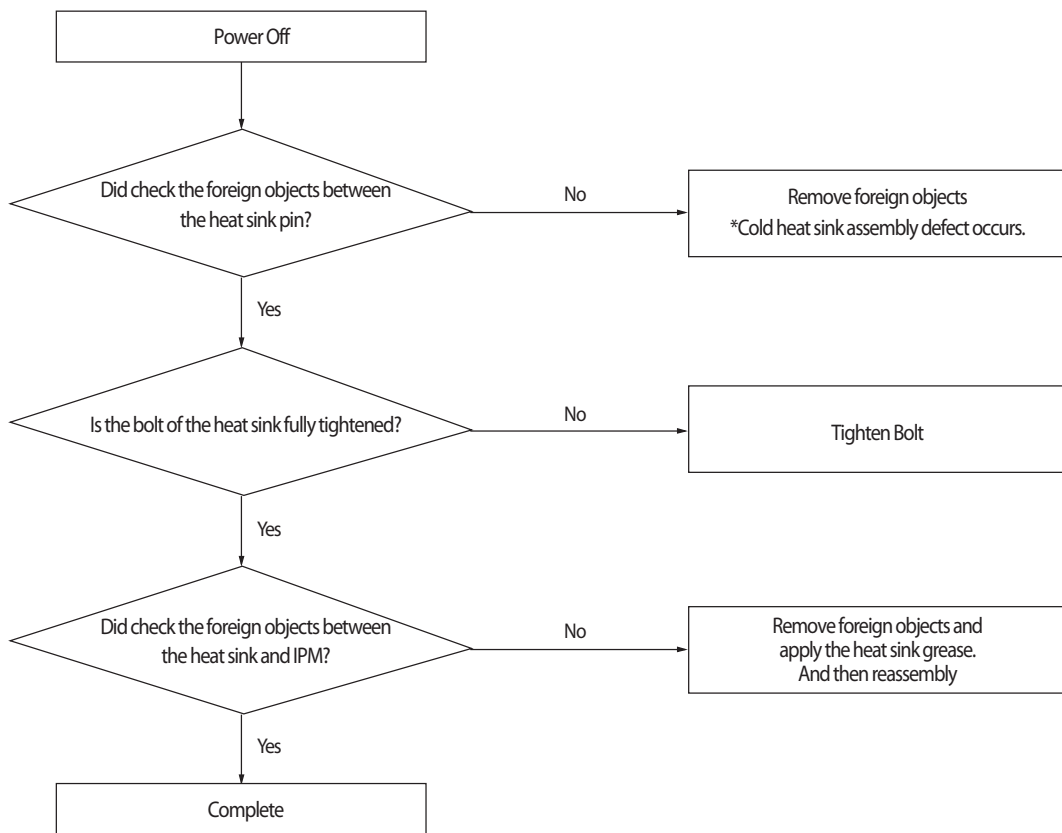

4-4-71 Over-Voltage Error of an Outdoor Fan Motor

Outdoor unit display	E456
Indoor unit display	-
Criteria	• When the current of an operating outdoor fan motor is more than 7A for 1 minute
Cause of problem	• Outdoor fan motor lock or defect • Occurs by abrupt start or overload

1. How to check

- 1) Check if outdoor fan motor rotates or is locked
- 2) If it is not locked, the above error occurs due to overload and signals by abnormal operation, and it indicates the overload status. Thus, it is not breakdown.
- 3) Need to check if there is a problem with fan load status

4-4-72 Counter-Rotation Error of an Outdoor Fan Motor

Outdoor unit display	E457
Indoor unit display	-
Criteria	• When the rotational direction of an outdoor fan motor is counter-clockwise before operating
Cause of problem	• Due to wind that can run the fan counter-wise

1. How to diagnose

- 1) Check if the start instruction of outdoor unit's fan is counter-clockwise

2. How to check

- 1) It is a signal to protect a motor by checking the operational condition of the outdoor unit's fan motor without power so as not to operate it in counter-clockwise condition.
- 2) Check if there is wind strong enough to force a fan to rotate counter-clockwise where the outdoor unit is installed.

4-4-73 E45B : Compressor Excess Current Error

Outdoor Unit Display	E45B
Indoor Unit Display	×(Operation) ●(Reservation) ●(Blast) ●(Filter) ×(Defrost)
Judgment Method	• Error displayed if the CT sensor value of the relevant compressor is 20A or more and is maintained for more than 3 seconds.
Special Cause	• Breakdown of compressor/Faulty CT sensor

1. Inspection Method

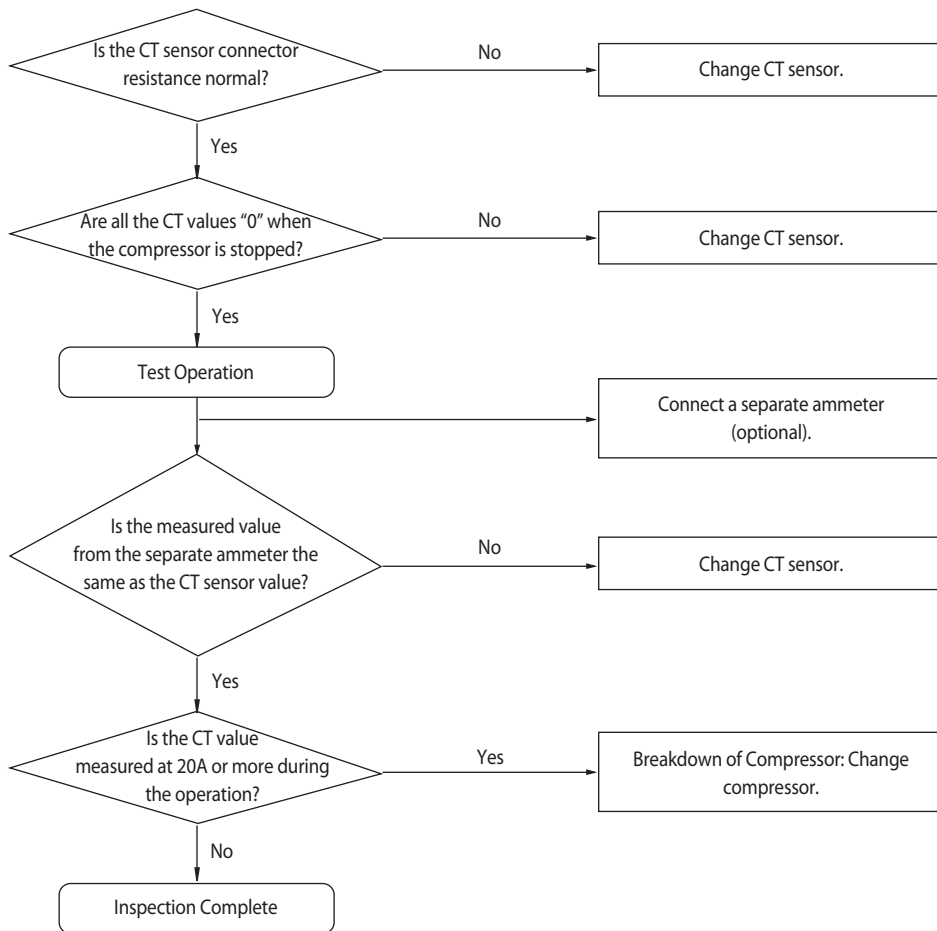

4-4-74 Compressor starting error

Outdoor unit display	E461 (INVERTER1 PCB) E361 (INVERTER2 PCB)
Judgment Method	<ul style="list-style-type: none"> · Startup, and then if the speed increase is not normally. · Detected by H/W or S/W.
Cause of problem	<ul style="list-style-type: none"> · Compressor connection error · Defective Compressor · Defective PCB

1. Cause of problem

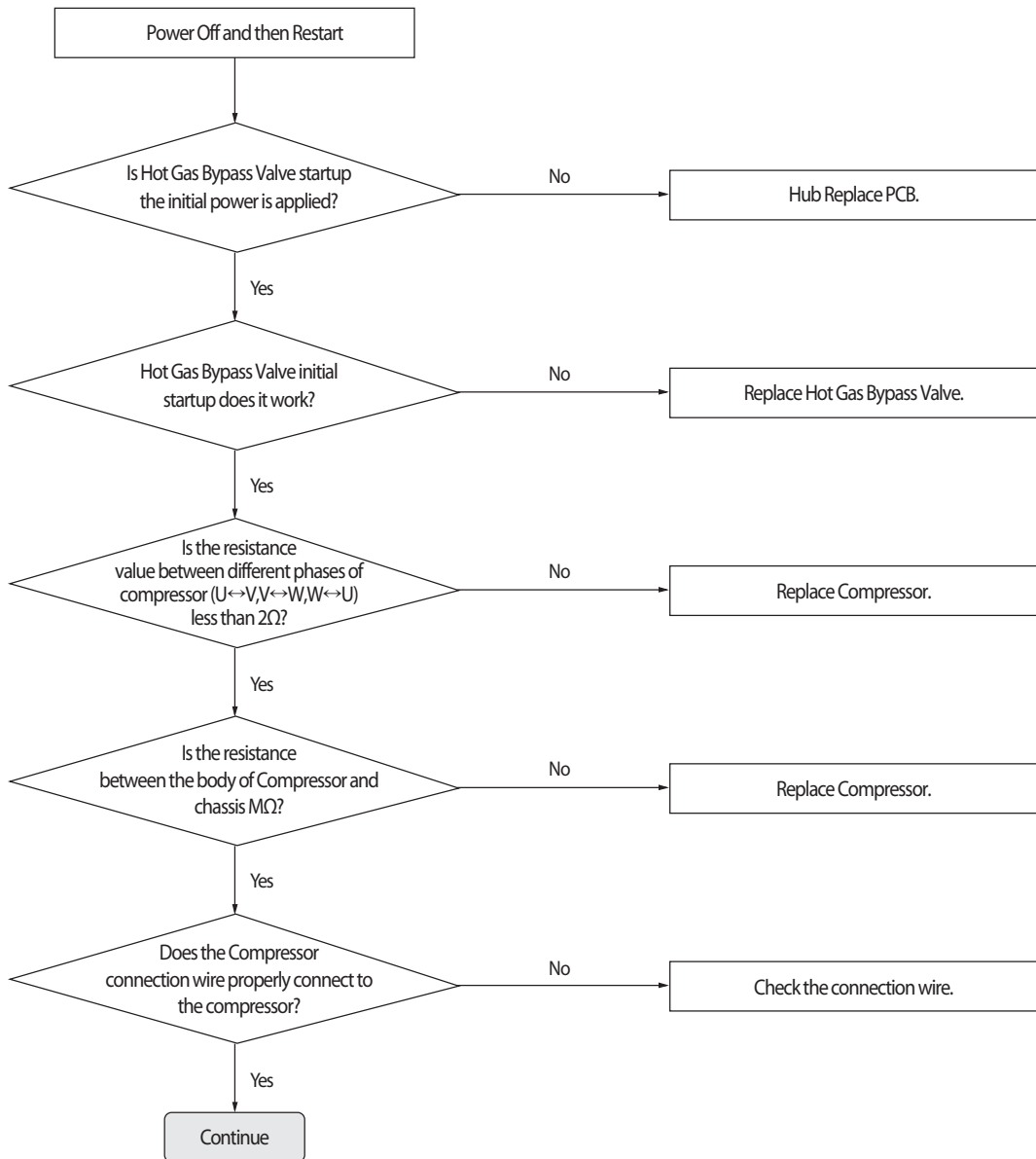

4-4-75 Inverter Overcurrent error

Outdoor unit display	<i>E464/E465</i> (INVERTER1 PCB) <i>E364/E365</i> (INVERTER2 PCB)	
Judgment Method	<ul style="list-style-type: none"> · Will occur if the overcurrent flowing in the IPM. · Detected by H/W or S/W 	
Cause of problem	<ul style="list-style-type: none"> · Installation defective · Comp. defective · PCB defective 	<ul style="list-style-type: none"> · Connection wire error · Motor defective

1. Cause of problem

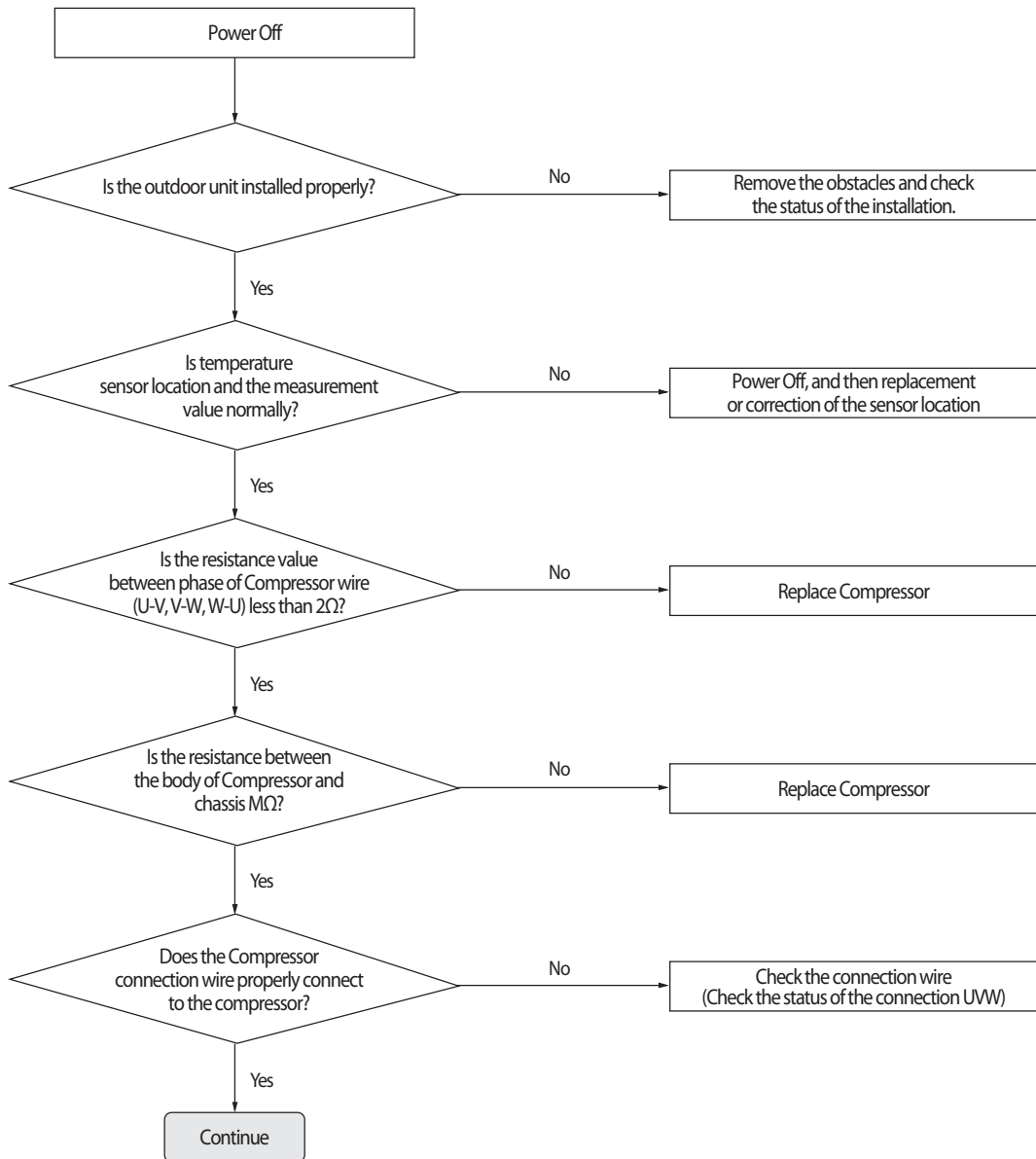

4-4-76 Overvoltage / Low voltage error

Outdoor unit display	E466 (INVERTER1 PCB) E366 (INVERTER2 PCB)
Judgment Method	<ul style="list-style-type: none"> · N-phase wiring error and EMI Fuse short. · DC-Link Overvoltage / Low voltage occurs.
Cause of problem	<ul style="list-style-type: none"> · Check the input wiring · EMI Fuse short

1. Cause of problem

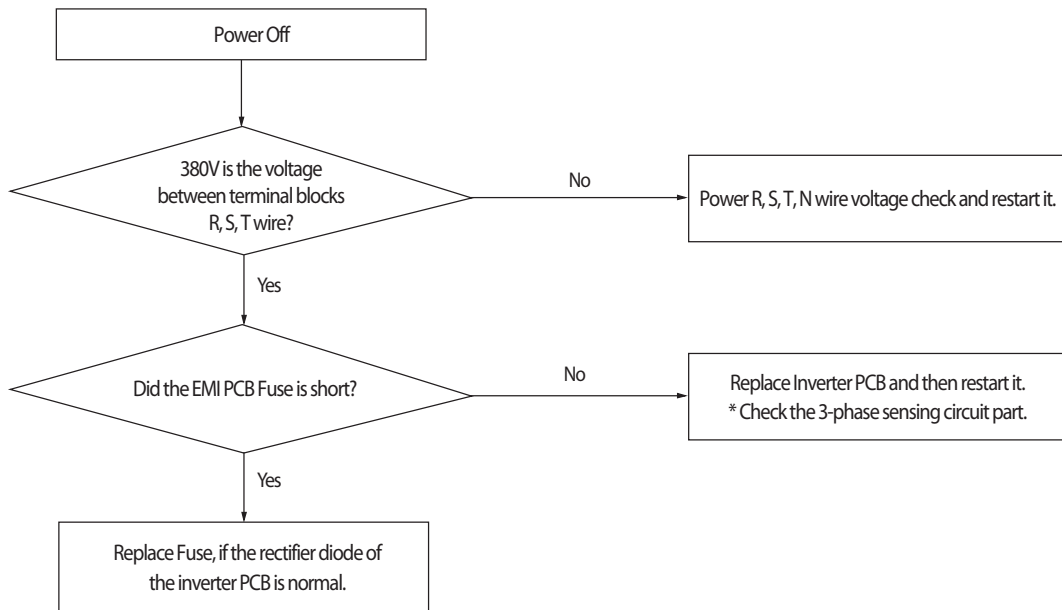

4-4-77 DC Link voltage sensor error

Outdoor unit display	<i>E469</i> (INVERTER1 PCB) <i>E369</i> (INVERTER2 PCB) <i>E496</i> (OUTDOOR FAN 1 PCB) <i>E396</i> (OUTDOOR FAN 2 PCB)
Judgment Method	· DC voltage detection : Judged as an error if the detected value is more than 2.8V or 0.2V less than
Cause of problem	· Input voltage defective · AC Power wiring error · Momentary Overvoltage / Low voltage occurs · PCB voltage sensing circuit defective

1. Cause of problem

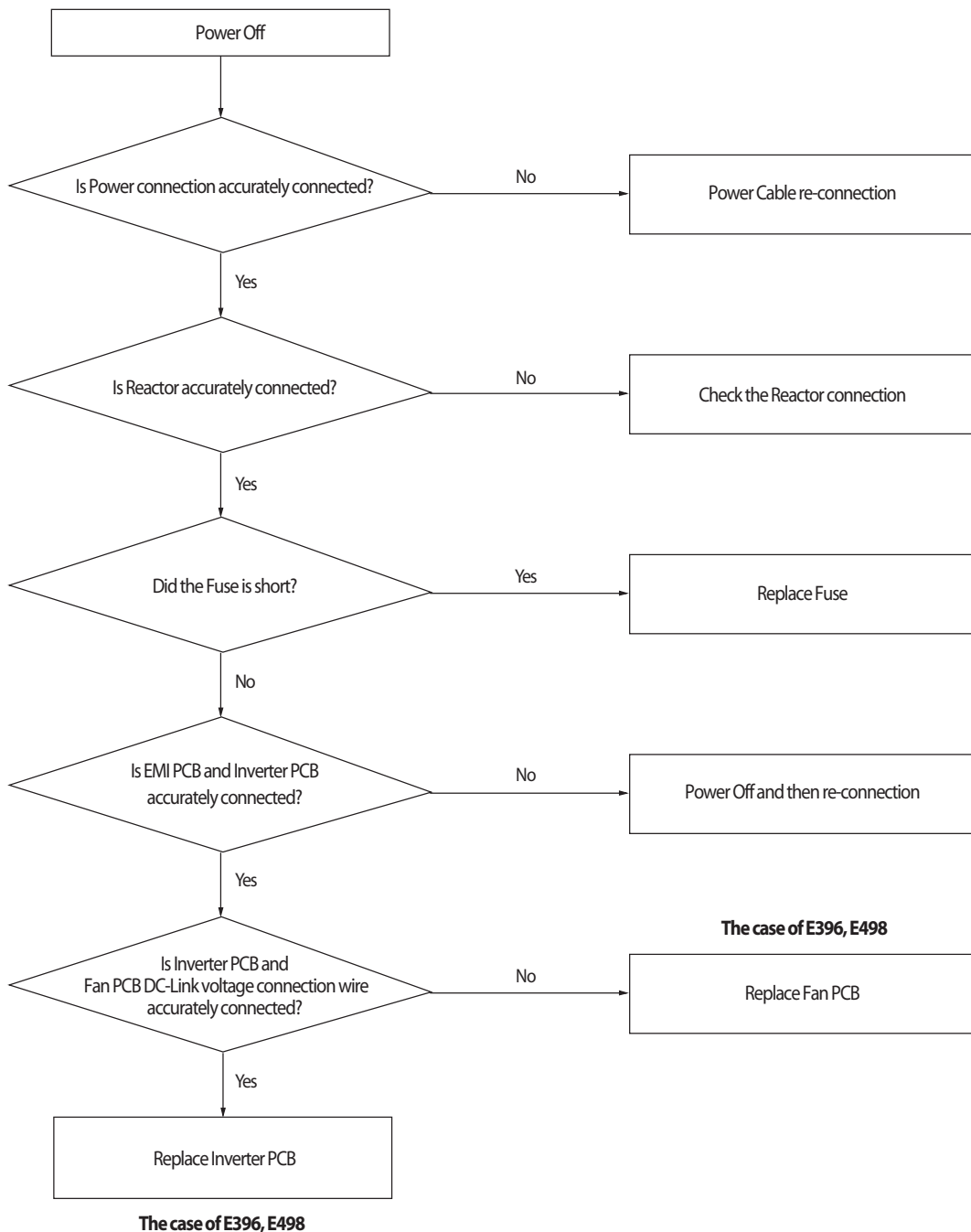

4-4-78 Liquid Compression Prevention Control

Outdoor Unit Display	E477
Indoor Unit Display	-
Judgment Method	• SUMP temperature decrease & DSH < 5°C 25 min.
Special Cause	• EVI EEV and super cooler, liquid bypass valve leakage, refrigerant overcharge, indoor unit EEV leakage, direct connection between indoor liquid pipe-gas pipe, faulty main EEV, and failure to operate compressor

1. Inspection Method

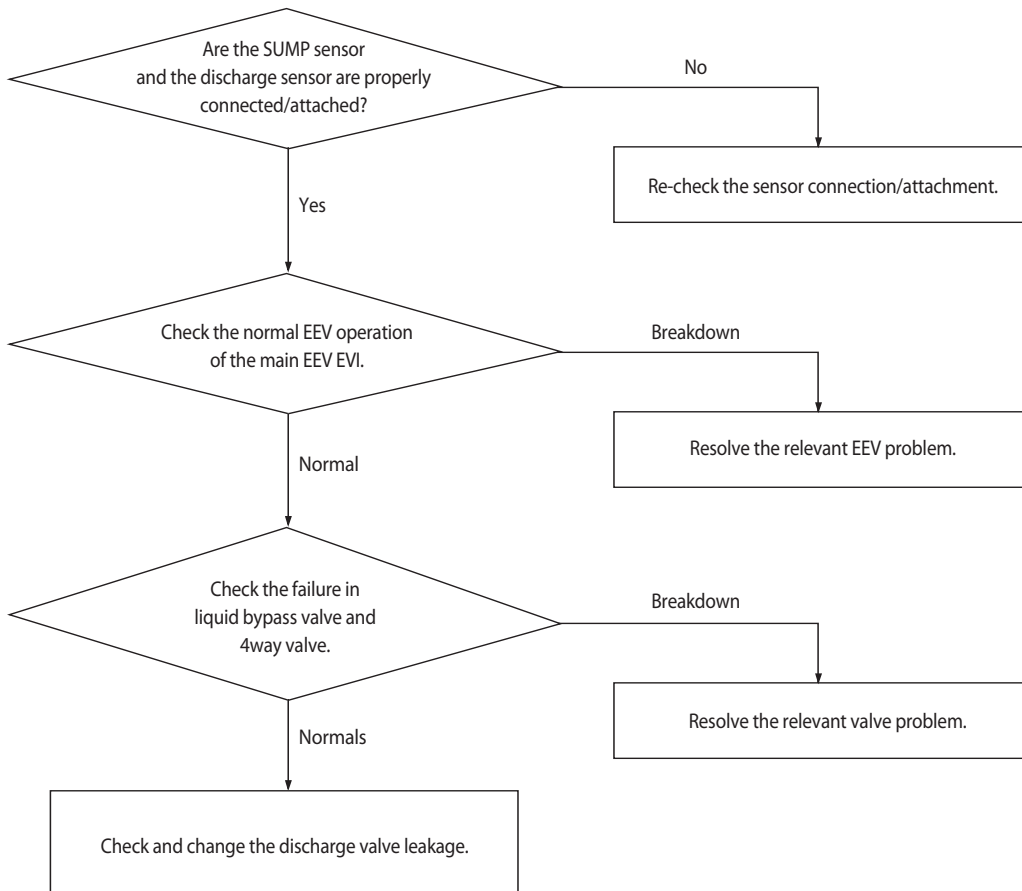

4-4-79 Fan Motor Overcurrent error

Outdoor unit display	<i>E478/E489</i> (FAN PCB(FAN1)) <i>E378/E389</i> (FAN PCB(FAN2))
Judgment Method	<ul style="list-style-type: none"> · Occurs when overcurrent flows in the IPM. · Detected by H/W or S/W
Cause of problem	<ul style="list-style-type: none"> · Installation error · Defective Comp · Defective PCB · Connector error · Defective Motor

1. Cause of problem

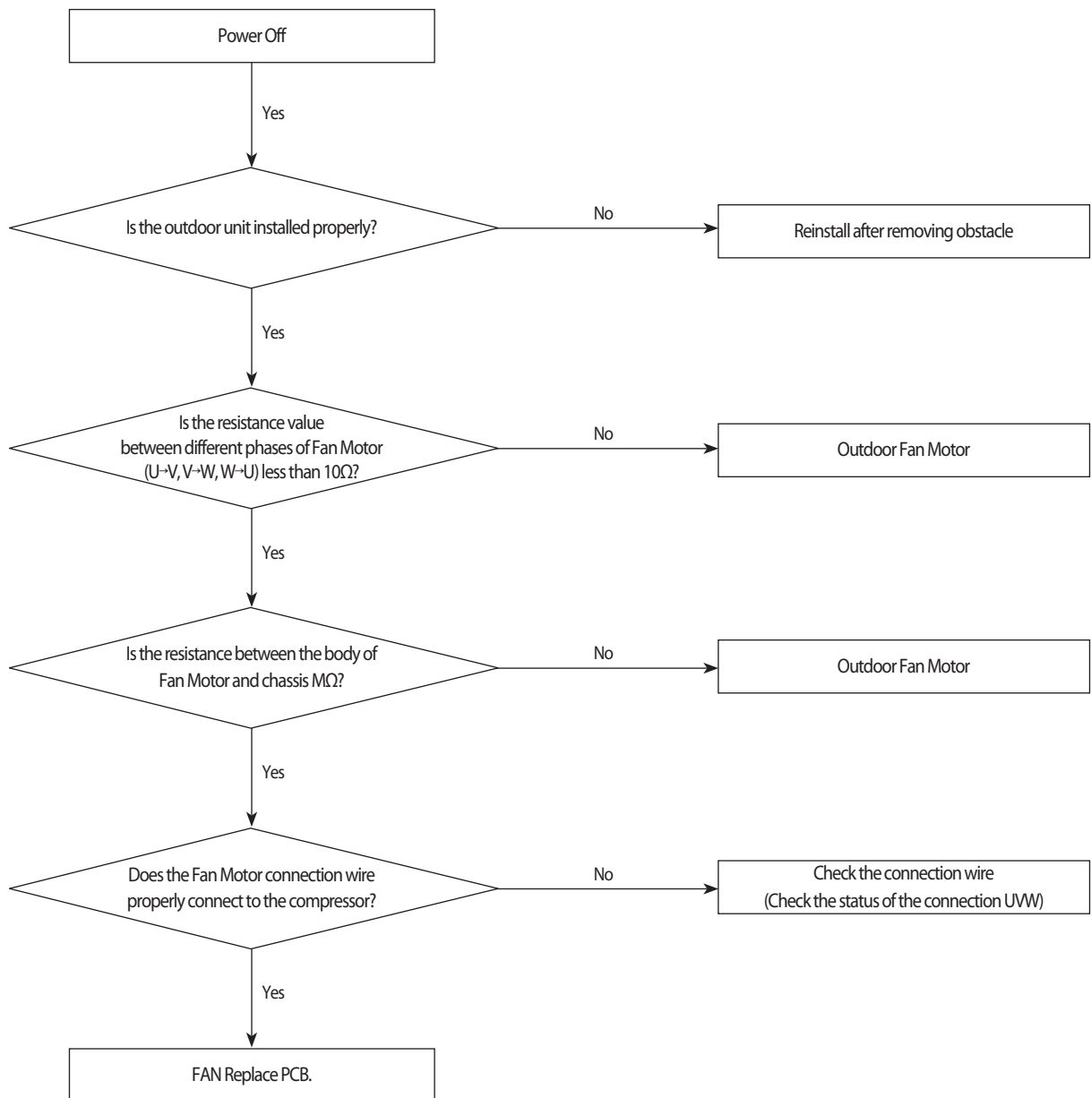

4-4-80 Input / Output Current sensor error

Outdoor unit display	<p><i>E485</i> INVERTER1 PCB(Input Current sensor)</p> <p><i>E385</i> INVERTER2 PCB(Input Current sensor)</p> <p><i>E468</i> INVERTER1 PCB(Output Current sensor)</p> <p><i>E368</i> INVERTER 2 PCB(Output Current sensor)</p> <p><i>E493</i> OUTDOOR FAN PCB (FAN1 Output Current sensor)</p> <p><i>E393</i> OUTDOOR FAN PCB (FAN2 Output Current sensor)</p>
Judgment Method	<ul style="list-style-type: none"> · Sensor Output detection : Judged as an error if the detected value is more than 2.8V or 0.2V less than
Cause of problem	<ul style="list-style-type: none"> · Input voltage defective · PCB voltage sensing circuit defective

1. Cause of problem

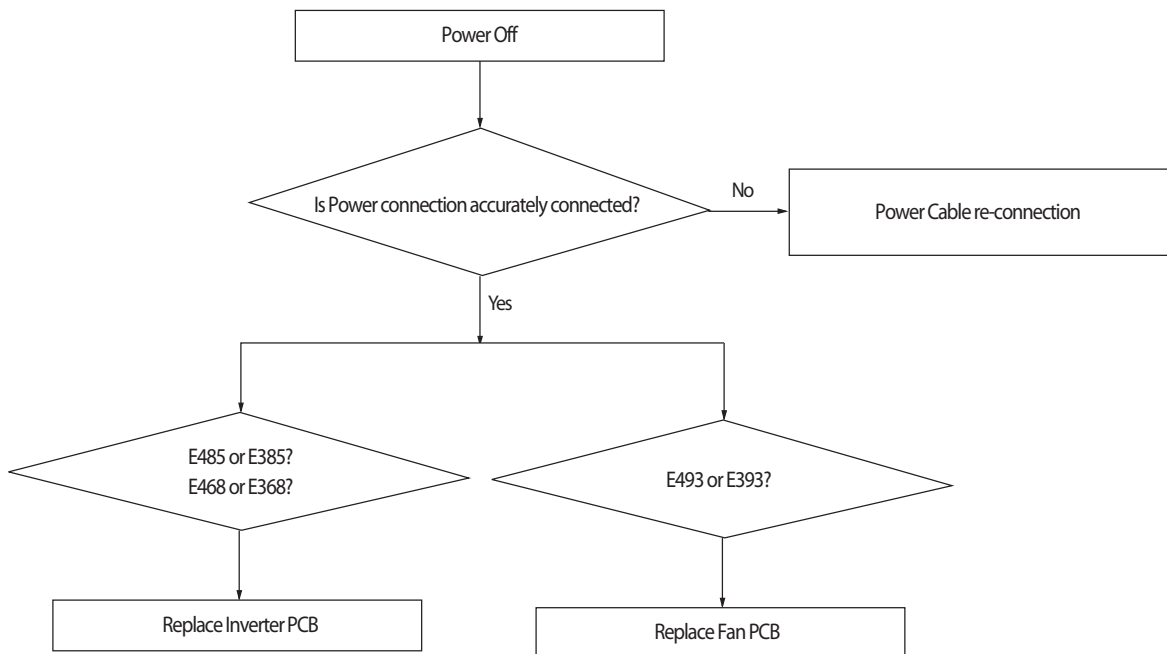

4-4-81 Outdoor Fan PCB Overvoltage / Low voltage error

Outdoor unit display	<i>E486</i>
Judgment Method	<ul style="list-style-type: none"> · N-phase wiring error and EMI Fuse short. · DC-Link Overvoltage / Low voltage occurs.
Cause of problem	<ul style="list-style-type: none"> · Check the input wiring · EMI Fuse short

1. Cause of problem

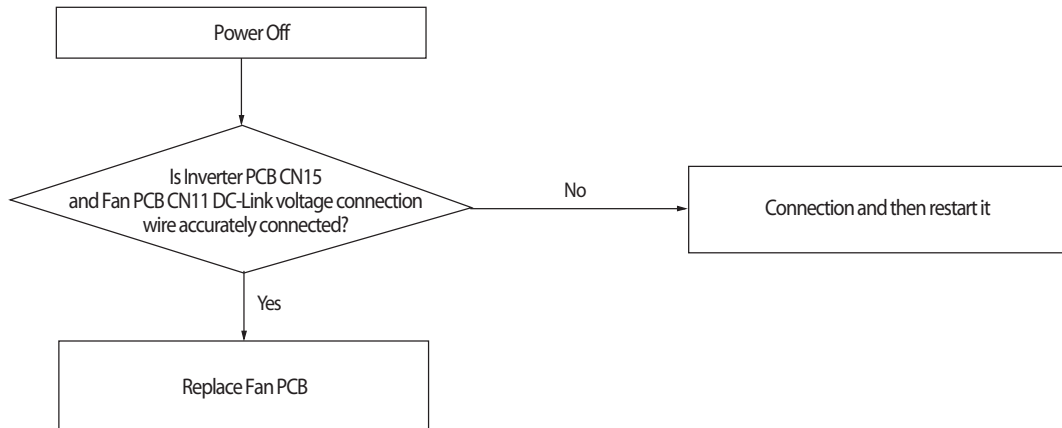

4-4-82 Hall IC(Fan) error

Outdoor unit display	<i>E487</i> (FAN PCB(FAN1)) <i>E387</i> (FAN PCB(FAN2))
Judgment Method	<ul style="list-style-type: none"> · Fan rotation defective or vibration and noise of the defective operation. · Hall IC there is no signal input.
Cause of problem	<ul style="list-style-type: none"> · Connection status error. · Hall IC wire disconnection. · Defective circuit parts and defective manufacturing. · Fan Motor defective.

1. Cause of problem

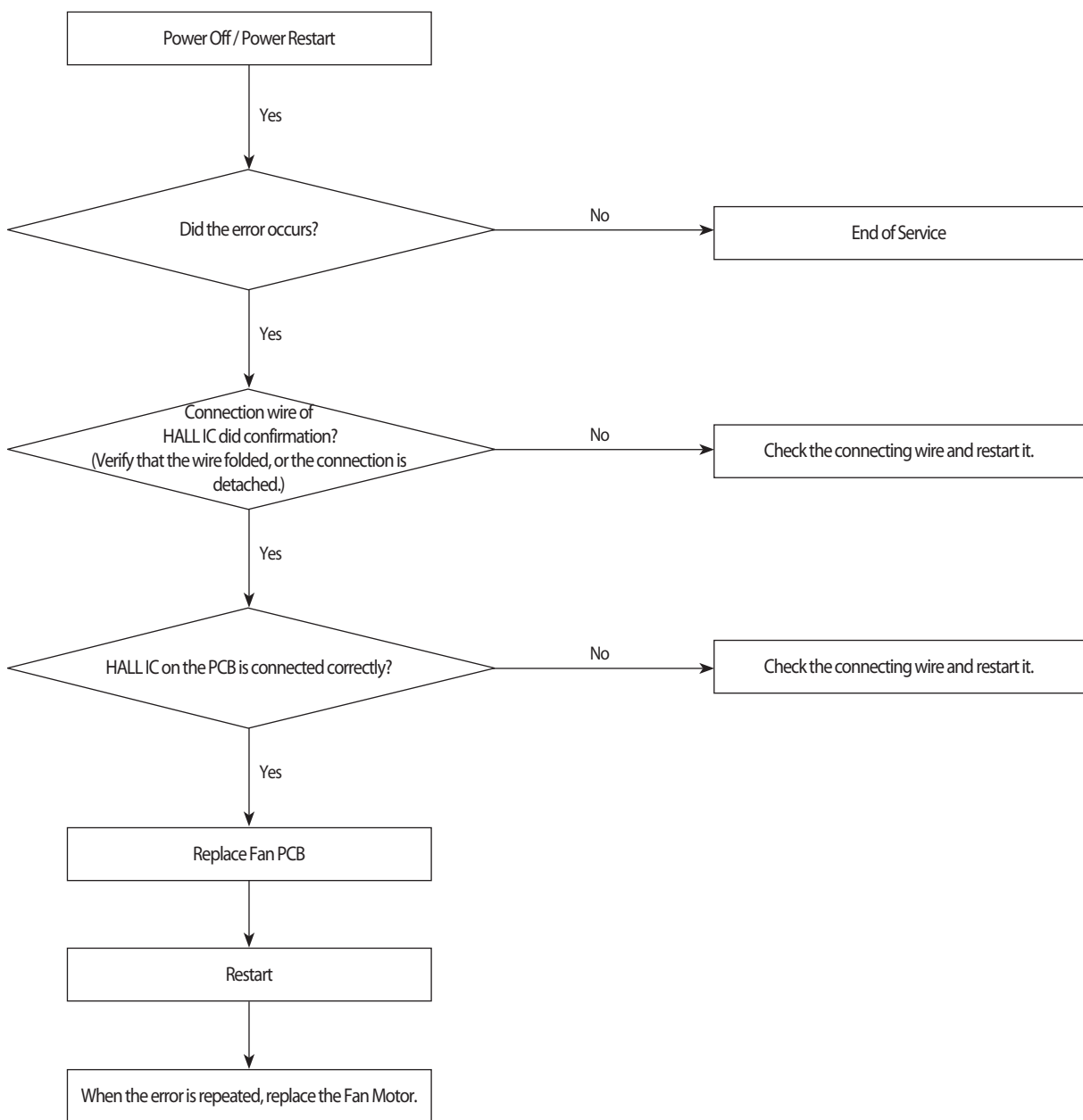

4-4-83 Inverter Overheat error

Outdoor unit display	E500 (INVERTER1 PCB) E400 (INVERTER2 PCB)
Judgment Method	· IGBT module internal temperature : 105°C more than (E500, E400)
Cause of problem	· Cooling Pin and the IGBT junction part assembly defective. · Refrigerant cooling heat sink and refrigerant piping assembly defective. · Assembled bolt defective.

Both end resistance values of IGBT module pin(8, 9 pin)

Temperature [°C]	NTC [ohm]	AD [V]	Temperature [°C]	NTC [ohm]	AD [V]
10	9000	2.58	100	500	0.55
20	6000	2.33	105	450	0.51
30	4000	2.03	110	380	0.44
40	3000	1.80	120	300	0.35
50	2000	1.47	130	250	0.30
60	1600	1.29	140	200	0.25
70	1200	1.07			
80	750	0.76			
90	650	0.68			

1. Cause of problem

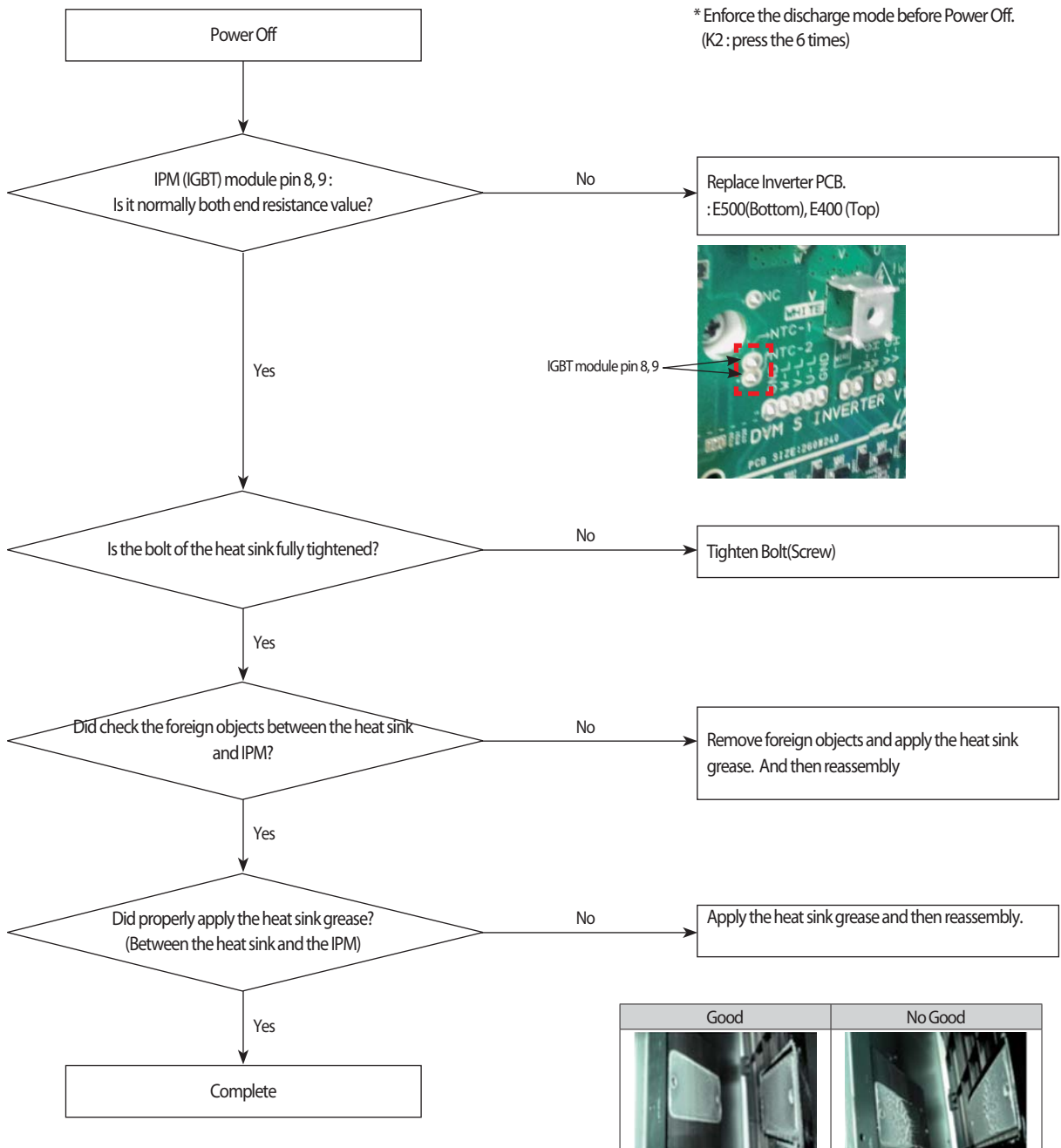

4-4-84 Model mismatching of Indoor unit.

Outdoor unit display	<i>E563</i>
Judgment Method	<ul style="list-style-type: none"> · Prior to July 2011, if the software version of the indoor unit. · Prior to July 2011, if the software version of the indoor unit.
Cause of problem	<ul style="list-style-type: none"> · Check the software version of the indoor unit. · Check whether the support of the indoor unit.

1. Cause of problem

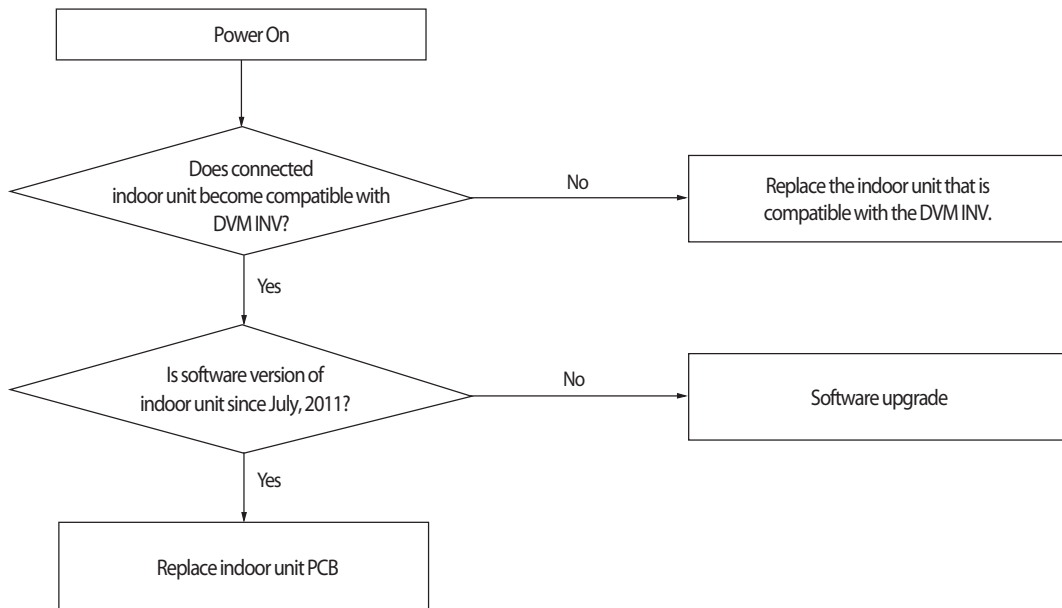

4-4-85 Breakdown of an EEV(1st)

1. How to diagnose

Detect only on cooling operation. (No detection during heating operation.)

During cooling operation, the temperature of the inlet or outlet ducts of heat exchanger is kept lower than 0°C for more than 20 minutes without cessation

2. How to check

1) Check if the wire of an electronic expansion valve is correctly connected to the PCB of indoor unit.

2) Check if the coil of an electronic expansion valve is correctly plugged into the main body.

3) Check if there is any rust on the surface of the coil of an electronic expansion valve with the naked eye, and then check the resistance between each terminal to find any wire breaking or short circuit.

4) Press the RESET KEY (K3) of the outdoor unit then see if the same error occurs.

- In case of closure problem, operate the indoor unit in which the error has occurred.

- In case of opening problem, please do not operate the indoor unit in which the error has occurred.

5) If there is no problem with the above checkup items, replace the electronic expansion valve of the troubled indoor unit.

- As an electronic expansion valve replacement is tricky work that requires collecting refrigerants in all systems, please make sure to check the above items before replacement.

4-4-86 Breakdown of an EEV closure

1. How to diagnose

1) During cooling operation (It must satisfy each of the following conditions for over 20minutes.)

Tair in - Teva in in $\geq 4^{\circ}\text{C}$	OK
Tair in - Teva out in $\geq 4^{\circ}\text{C}$	OK
Tcond, out - Tair, out $> 3^{\circ}\text{C}$	NO
Compressor in operation & Indoor unit operation & Thermo On	OK
Error details	EEV closure breakdown

2) During heating operation (It must satisfy each of the following conditions for over 20minutes.)

- When more than 2 indoor units are on Thermo On heating operating.
- When average high pressure is over 25 kg/cm²G
- 5 minutes after finishing Safety Start.
- Keep indoor units' T(Eva_IN)<T(Room)+3°C and T(Eva_Out)<T(Room)+3°C condition for more than five minutes.

2. How to check

- 1) Check if the wire of an electronic expansion valve is correctly connected to the PCB of indoor unit.
- 2) Check if the coil of an electronic expansion valve is correctly plugged into the main body.
- 3) Check if there is any rust on the surface of the coil of an electronic expansion valve with the naked eye, and then check the resistance between each terminal to find any wire breaking or short circuit.
- 4) Press the RESET KEY (K3) of the outdoor unit then see if the same error occurs.
 - In case of closure problem, operate the indoor unit in which the error has occurred.
 - In case of opening problem, please do not operate the indoor unit in which the error has occurred.
- 5) If there is no problem with the above checkup items, replace the electronic expansion valve of the troubled indoor unit.
 - As an electronic expansion valve replacement is tricky work that requires collecting refrigerant in all systems, please make sure to check the above items before replacement.

4-4-87 Electronic expansion valve closing malfunction (2nd stage)

Outdoor unit display	1 st stage inspection: <i>P702</i> (only displays on outdoor unit) 2 nd stage inspection: <i>E 152</i> ↔ <i>A</i> ^{x x x} (x x x: error occurred)
Indoor unit display	×(Operation) ●(Reservation) ●(Blast) ●(Filter) ×(Defrost)
Criteria	• Please refer to determining method below
Cause of problem	• Faulty indoor unit electronic expansion valve action (valve will not open) • Address setup error in indoor unit (RAC) using EEV KIT [®]

1. Inspection Method

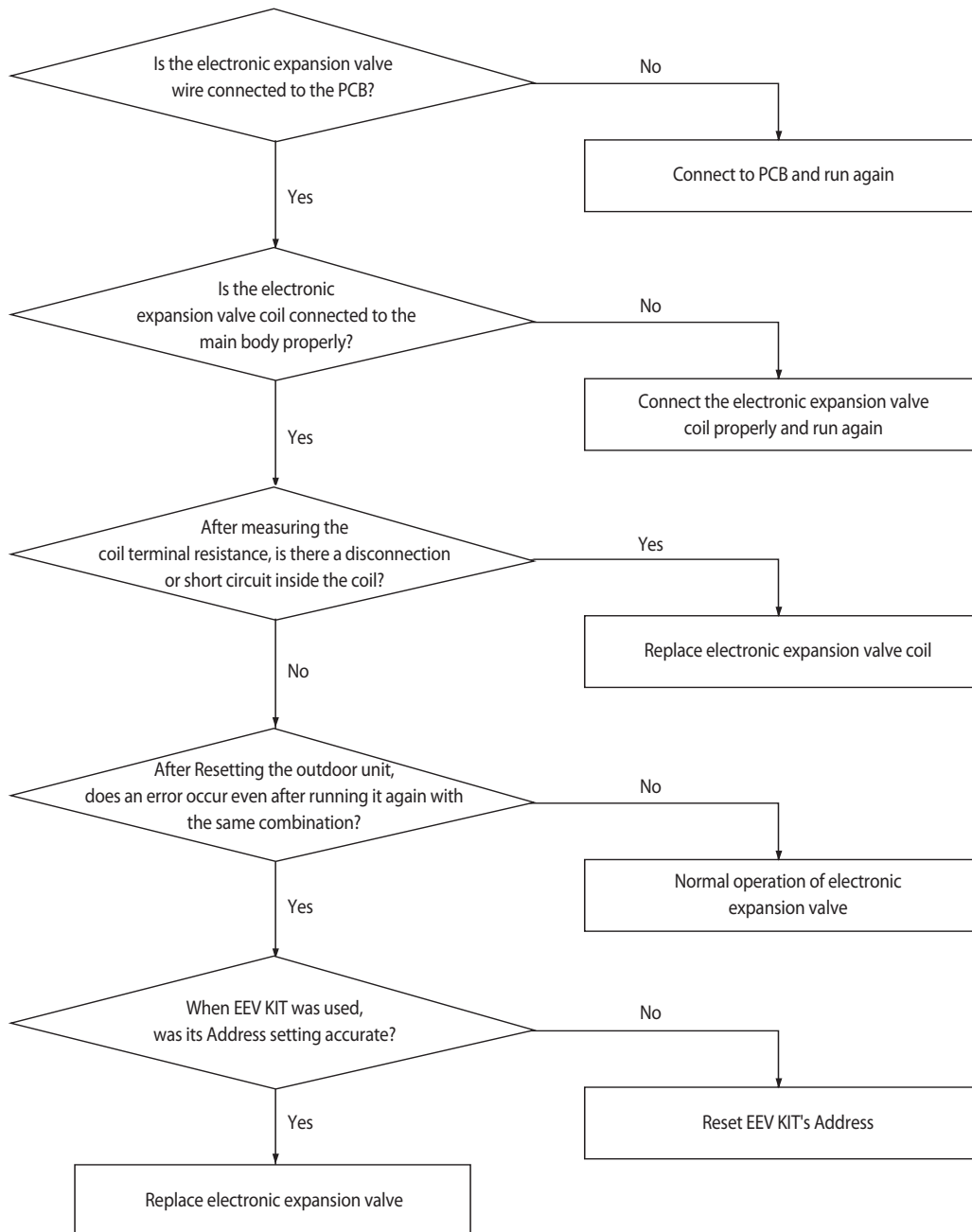

4-4-88 Electronic expansion valve opening malfunction (2nd stage)

Outdoor unit display	1 st stage inspection: <i>P703</i> (only displays on outdoor unit) 2 nd stage inspection: <i>E151</i> ↔ <i>A^{x x x}</i> (x x x: indoor unit address of where error occurred)
Indoor unit display	×(Operation) ●(Reservation) ●(Blast) ●(Filter) ×(Defrost)
Criteria	• Please refer to determining method below
Cause of problem	• Faulty indoor unit electronic expansion valve action (refrigerant will leak into the stopped indoor unit) • Address setup error in indoor unit (RAC) using EEV KIT

1. Inspection Method

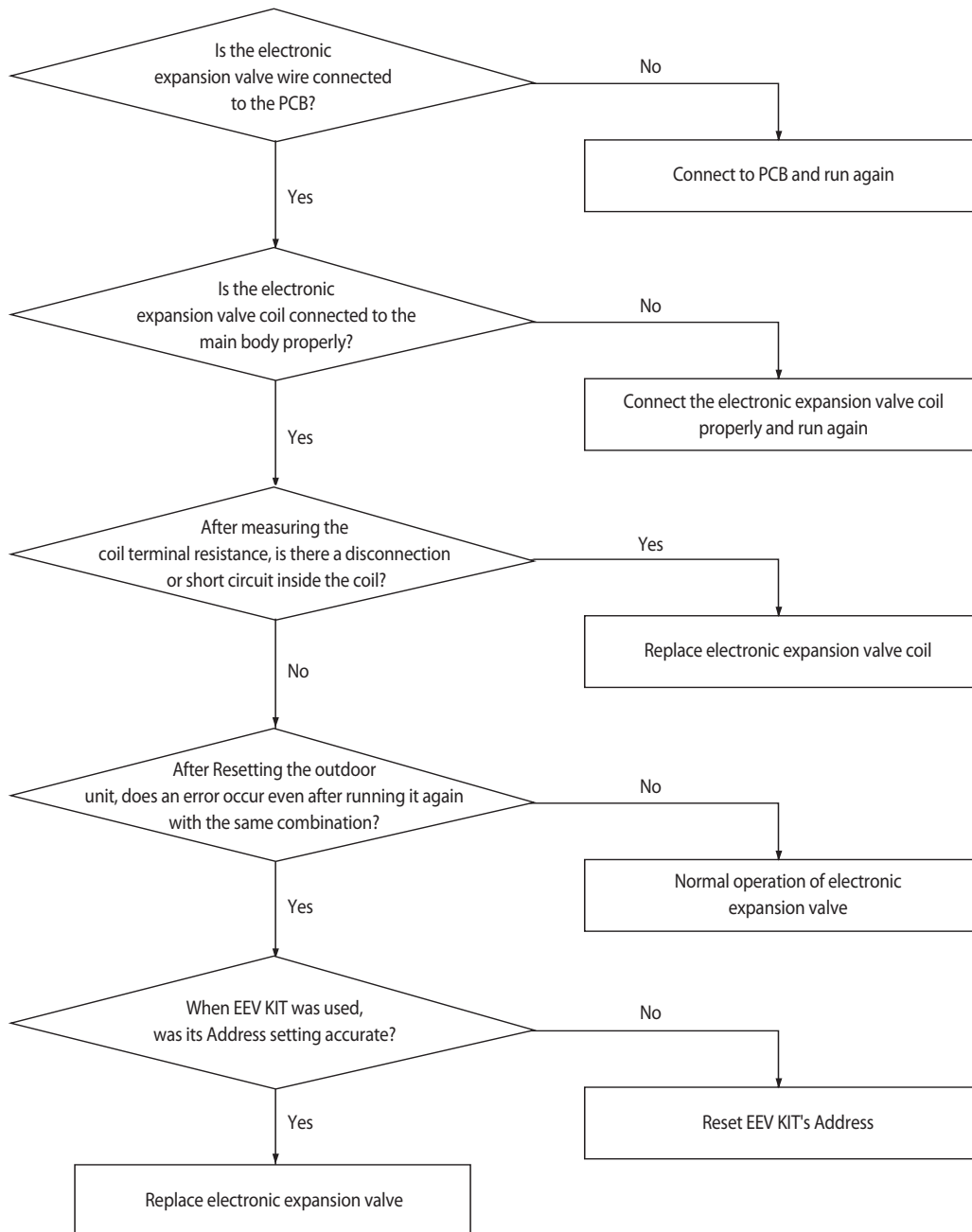

5. PCB Diagram and Parts List

5-1 Indoor Unit

5-1-1 Slim 1 way cassette type (medium)

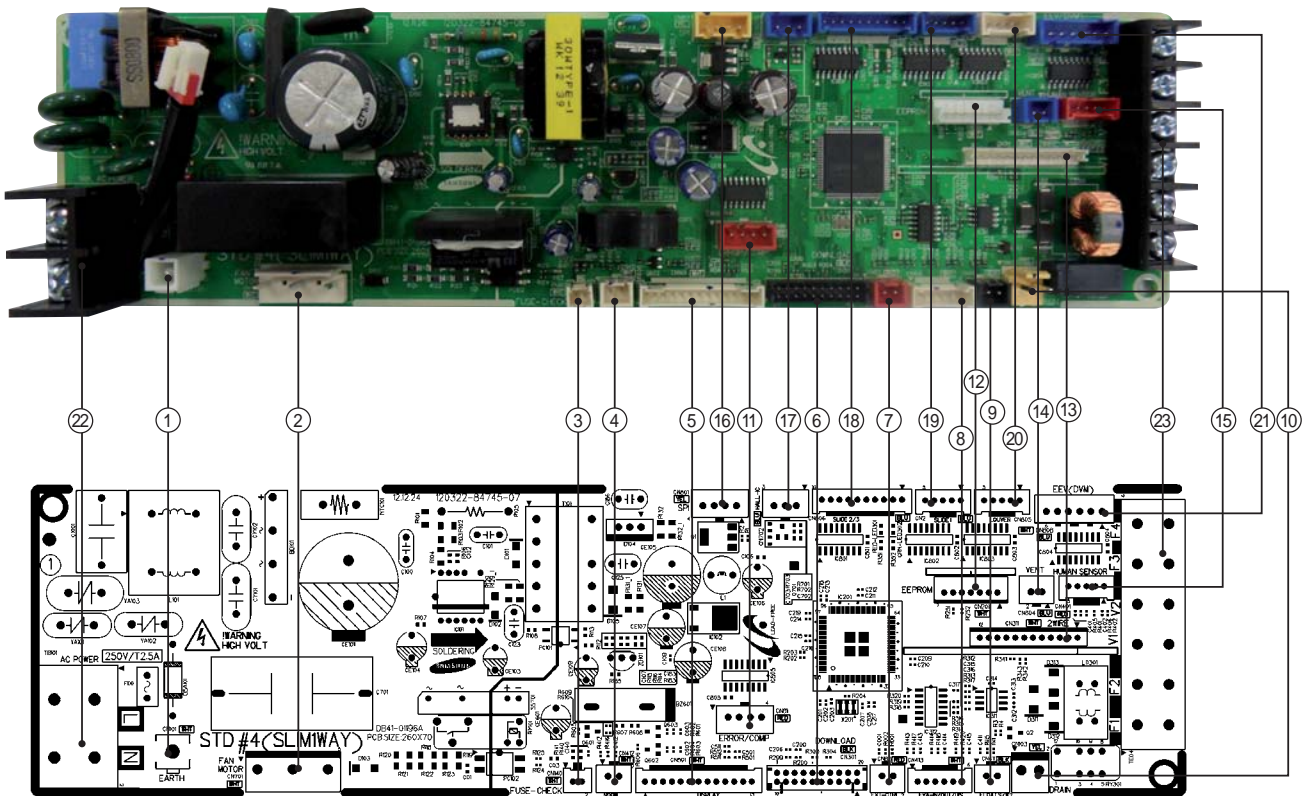

Slim 1 way cassette type (medium)(cont.)

① CN101-GND #1: GND	② CN701-FAN MOTOR #1: POWER(N) #3 : SSR MOTOR POWER(L) #5 : POWER(N)	③ CN140-FUSE CHECK #1: FUSE CHECK SIGNAL #2: GND	④ CN412-ROOM THERMISTOR #1 : ROOM THERMISTOR #2 : GND
⑤ CN501-DISPLAY #1: DC12V #2: LED_0 #3: LED_1 #4: LED_2 #5: LED_3 #6: LED_4 #8: REMOCON_OUTPUT_SIGNAL #9: AUTO SWITCH #10: REMOCON_INPUT_SIGNAL #11: GND #12: DC5V #13: GND	⑥ CN301-DOWNLOAD #1: DC12V #2: GND	⑦ CN83-EXT CTRL #1: GND #2: EXT-CTRL SIGNAL	⑧ CN413:THERMISTOR #1 : EVA-IN THERMISTOR #2 : GND #3 : EVA-OUT THERMISTOR #4 : GND #5 : DISCHARGE THERMISTOR #6 : GND
⑨ CN411-FLOAT SWITCH #1: F/S SIGNAL #2: GND	⑩ CN103-DRAIN PUMP #1: D/ P POWER(DC12V) #2: GND	⑪ CN81-ERROR/COMP CHECK #1: DC12V #2: ERROR SIGNAL OUTPUT(GND) #3: DC12V #4: COMP/OPER. SIGNAL OUTPUT(GND)	⑫ CN201-EEPROM #1: GND #3: DC5V #4: EEPROM_SELECT #5: EEPROM_SO #6: EEPROM_SI #7: EEPROM_CLK
⑬ CN311-2WIRED REMOCON	⑭ CN804-VENTILATOR #1: DC12V #2: VENT SIGNAL OUTPUT(GND)	⑮ CN401-HUMAN SENSING #1: DC12V #2: HUMAN SENSOR COMM(TXD) #3: HUMAN SENSOR COMM(RXD) #4: GND	⑯ CN801-SPI #1: GND #2: GND #3: SPI POWER OUTPUT(DC12V)
⑰ CN702-HALL IC #1 : DC5V #2 : GND #3 : MOTOR FEEDBACK	⑱ CN806-SLIDE 2/3 #1 : DC12V #2~#5: LOUVER SIGNAL OUTPUT #6 : DC12V #7~#10: LOUVER SIGNAL OUTPUT	⑲ CN2-SLIDE 1 #1 : DC12V #2~#5: LOUVER SIGNAL OUTPUT	⑳ CN805-LOUVER #1 : DC12V #2~#5: LOUVER SIGNAL OUTPUT
㉑ CN808-EEV #1~#4: EEV SIGNAL OUTPUT #5 : DC12V #6 : DC12V	㉒ TB101-AC POWER #1: POWER(L) #2: POWER(N)	㉓ TE04-COMMUNICATION #1: COM1(F1) #2: COM1(F2) #3: V1(DC12V) #4: V2(GND) #5: COM2(F3) #6: COM2(F4)	

5-1-2 2 way cassette type

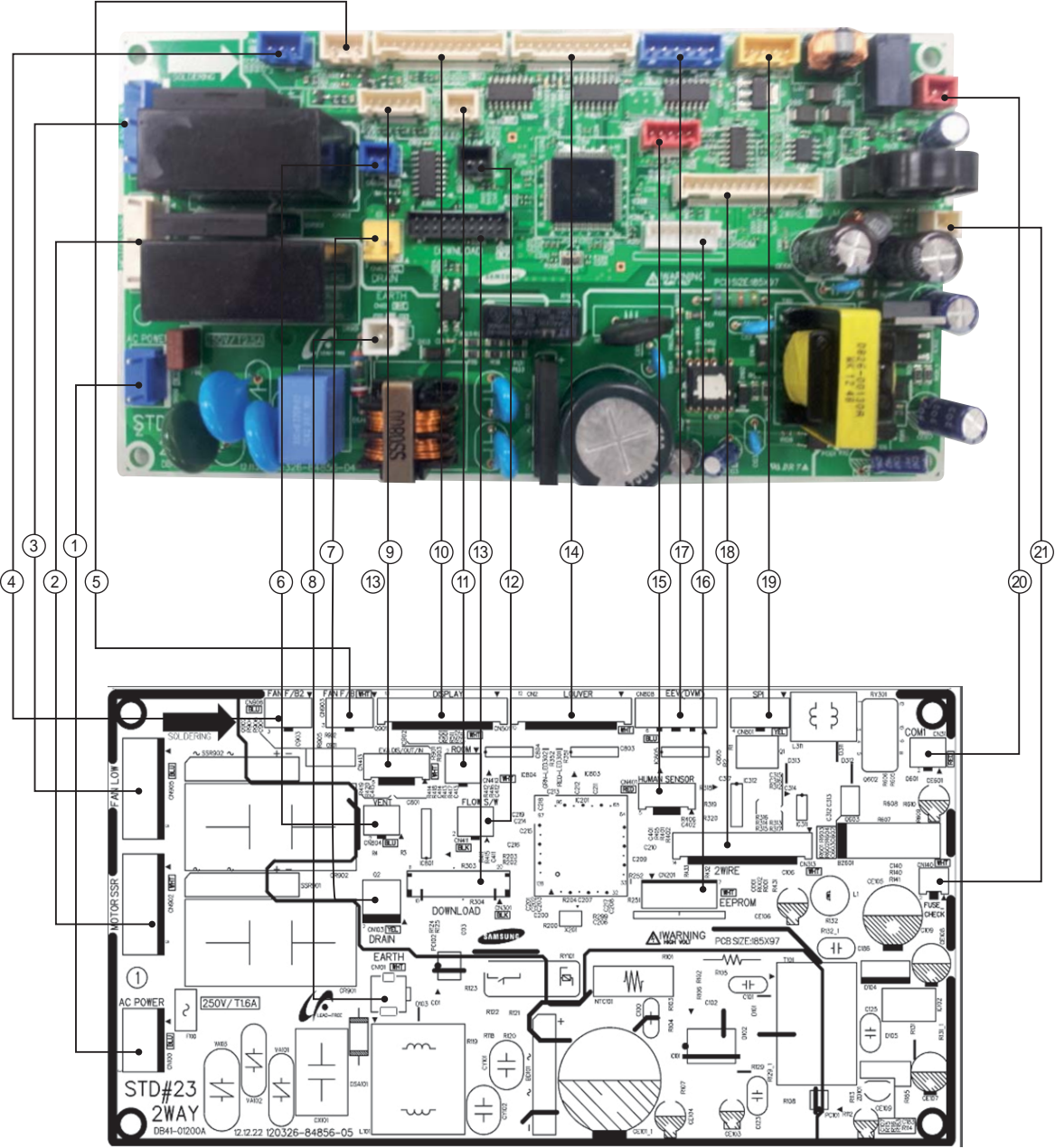

2 way cassette type (cont.)

① CN100-AC INPUT #1: L #2: N	② CN902-SSR MOTOR1 #1: N #2: L #3: N	③ CN905-SSR MOTOR2 #1: N #2: L #3: N	④ CN905-SSR FAN FEED BACK #1: VCC #2: FEEDBACK #3: GND
⑤ CN903-FAN FEED BACK #1: VCC #2: FEEDBACK #3: GND	⑥ CN804-VENT #1: 12V #2: VENT OUT	⑦ CN103-DRAIN PUMP #1: 12V #2: GND	⑧ CN101-EARTH
⑨ CN413- THERMO. #1 : EVA IN TEMP #2,4,6: GND #3 : EVA OUT TEMP #5 : DISCHARGE TEMP	⑩ CN901-DISPLAY #1: 12V #2~7: LED #8: REMOCON OUT #9: AUTO SW #10: REMOCON INT #11: GND #12: VCC	⑪ CN412-ROOM THERMO. #1: THERMOR INPUT #2: GND	⑫ CN411-FLOW SW #1: Flow SW INPUT #2: GND
⑬ CN301-MICOM DOWNLOAD	⑭ CN2-BLADE #1,2: 12V #3~6: BLADE CONTROL #7,8: 12V #9~12: BALDE CONTROL	⑮ CN401-HUMAN SENSOR #1: 12V #2,3: COM #5: GND	⑯ CN201-E2P MODULE
⑰ CN808-EEV VALVE #1~4: EEV CONTROL #5,6 : 12V	⑱ CN311-COMM	⑲ CN801-SPI #1,2 : GND #3 : SPI CONTROL	⑳ CN31-IN-OUT COMM.
㉑ CN140-FUSE CHECK #1: FUSE CHECK #2: GND			

5-1-3 4way cassette , mini 4way cassette type, Slim 1 way cassette type (large)

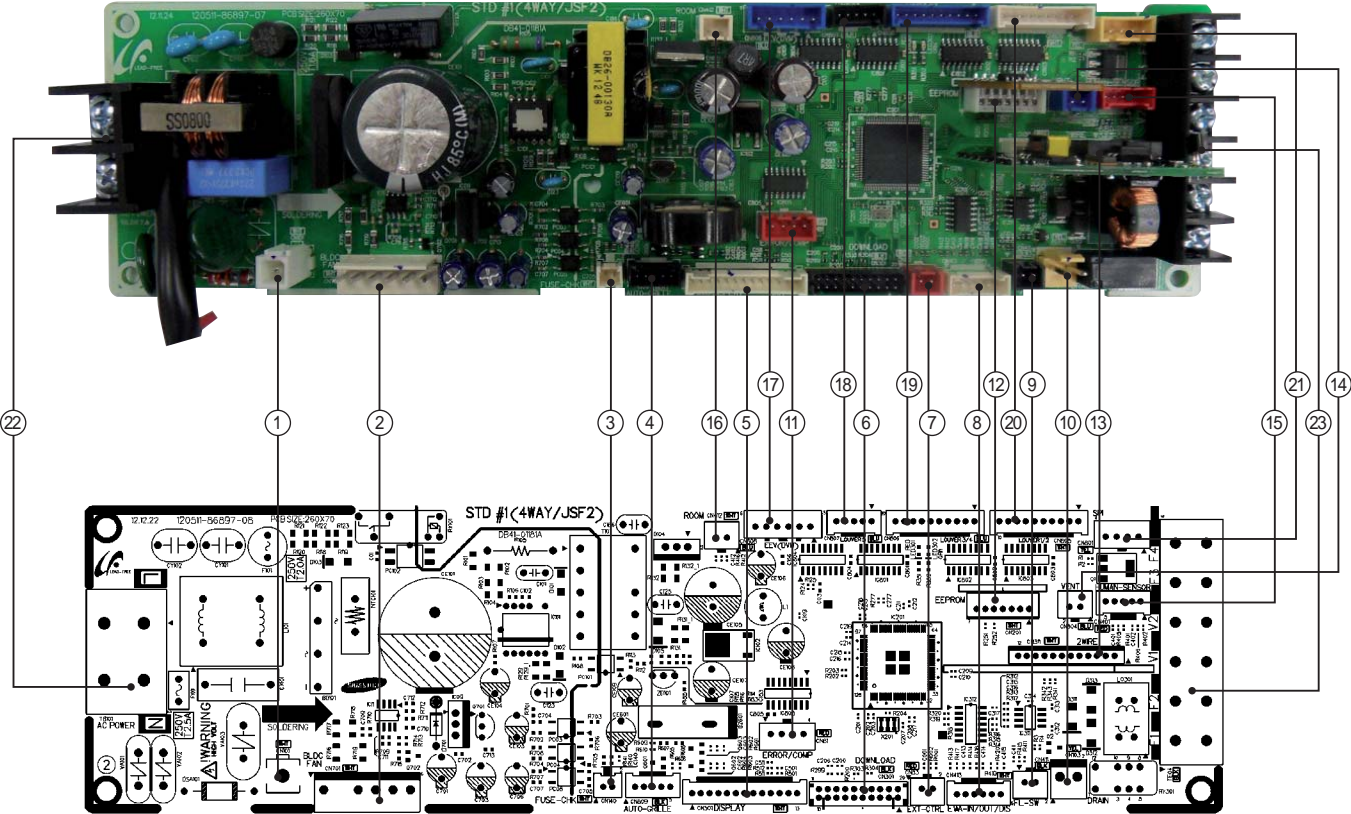

4way cassette , mini 4way cassette type, Slim 1 way cassette type (large)(cont.)

① CN101-GND #1: GND	② CN701-BLDC MOTOR #1: DC310V #3 : GND #4 : DC15V #5 : FAN RPM #6 : RPM FEEDBACK	③ CN140-FUSE CHECK #1: FUSE CHECK SIGNAL #2: GND	④ CN809-AUTO GRILL #1 : DC12V #4 : REMOCON SIGNAL #5 : GND
⑤ CN501-DISPLAY #1: DC12V #2: LED_0 #3: LED_1 #4: LED_2 #5: LED_3 #6: LED_4 #7: LED_5 #8: REMOCON_OUTPUT_SIGNAL #9 : AUTO SWITCH #10: REMOCON_INPUT_SIGNAL #11: GND #12: DC5V #13: GND	⑥ CN301-DOWNLOAD	⑦ CN83-EXT CTRL #1: GND #2: EXT-CTRL SIGNAL	⑧ CN413:THERMISTOR #1 : EVA-IN THERMISTOR #2 : GND #3 : EVA-OUT THERMISTOR #4 : GND #5 : DISCHARGE THERMISTOR #6 : GND
⑨ CN411-FLOAT SWITCH #1: F/S SIGNAL #2: GND	⑩ CN103-DRAIN PUMP #1: D/ P POWER(DC12V) #2: GND	⑪ CN81-ERROR/COMP CHECK #1: DC12V #2: ERROR SIGNAL OUTPUT(GND) #3: DC12V #4: COMP/OPER. SIGNAL OUTPUT(GND)	⑫ CN201-EEPROM #1: GND #3: DC5V #4: EEPROM_SELECT #5: EEPROM_SO #6: EEPROM_SI #7: EEPROM_CLK
⑬ CN311-2WIRED REMOCON	⑭ CN804-VENTILATOR #1: DC12V #2: VENT SIGNAL OUTPUT(GND)	⑮ CN401-HUMAN SENSING #1: DC12V #2: HUMAN SENSOR COMM(TXD) #3: HUMAN SENSOR COMM(RXD) #4: GND	⑯ CN412-ROOM THERMISTOR #1 : ROOM THERMISTOR #2 : GND
⑰ CN808-EEV #1~#4: EEV SIGNAL OUTPUT #5 : DC12V #6 : DC12V	⑱ CN807-LOUVER5 #1 : DC12V #2~#5: LOUVER SIGNAL OUTPUT	⑲ CN806-LOUVER3/4 #1 : DC12V #2~#5: LOUVER SIGNAL OUTPUT #6 : DC12V #7~#10: LOUVER SIGNAL OUTPUT	⑳ CN805-LOUVER1/2 #1 : DC12V #2~#5: LOUVER SIGNAL OUTPUT
㉑ CN801-SPI #1: GND #2: GND #3: SPI POWER OUTPUT(DC12V)	㉒ TB101-AC POWER #1: POWER(L) #2: POWER(N)	㉓ TE04-COMMUNICATION #1: COM1(F1) #2: COM1(F2) #3: V1(DC12V) #4: V2(GND) #5: COM2(F3) #6: COM2(F4)	

5-1-4 360 cassette
– MAIN PCB

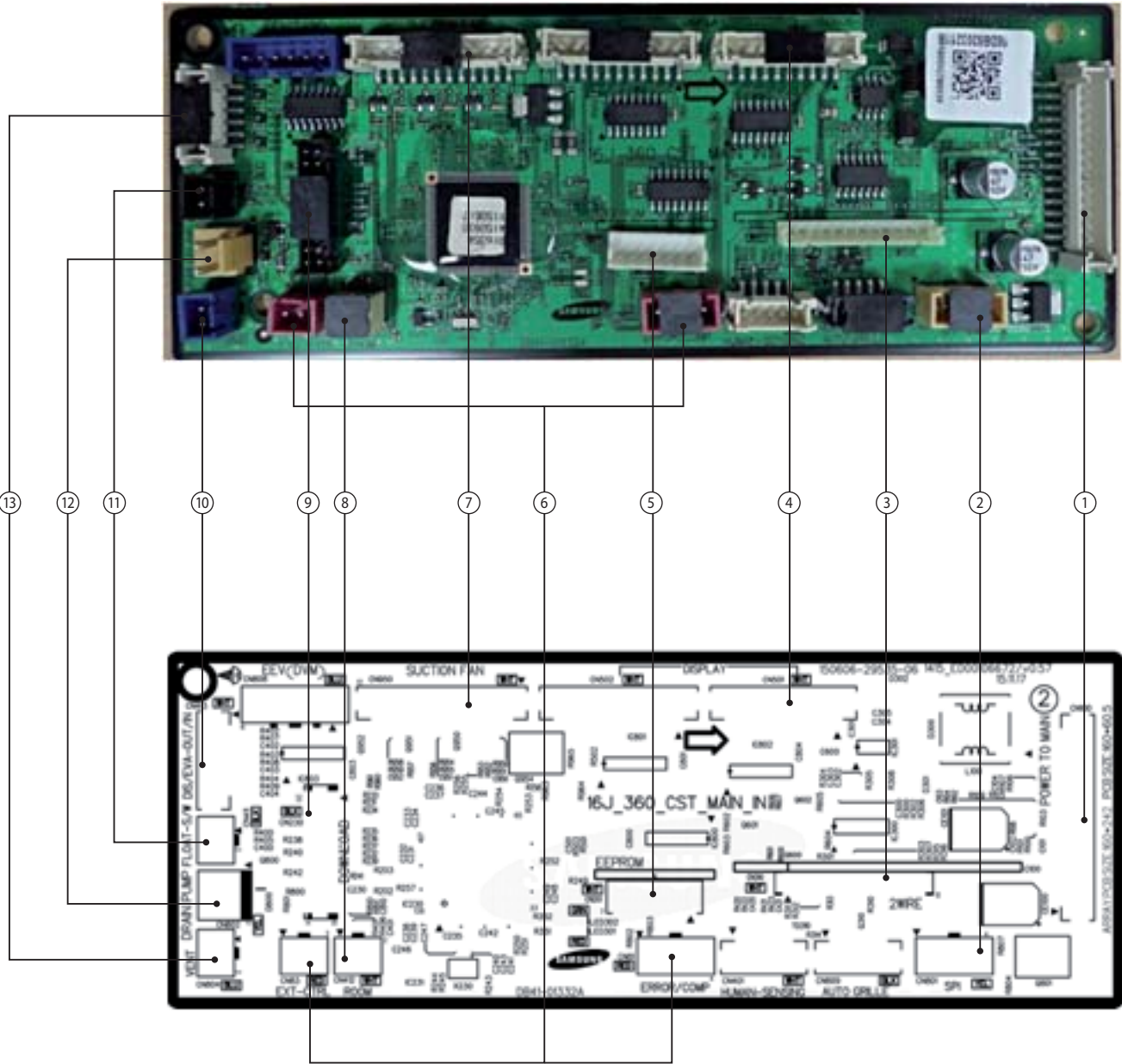

360 cassette

– MAIN PCB

<p>① CN100 – POWER TO MAIN CONNECTOR</p> <p>#1, 2: 12V #3, 4: SGND #5: 5V #6: FUSE SHORT/OPEN CHK #7: 15V OUTPUT ON/OFF #8: ZERO CROSSING SIGNAL #9: ZC STANDBY MODE ON/OFF #10: MAIN FAN MOTOR PWM #11: MAIN FAN MOTOR F/B #12: F3 - WIRED REMOTE CONTROL COMMUNICATION #13: F4 - WIRED REMOTE CONTROL COMMUNICATION #14: F1 - INDOOR/OUTDOOR COMMUNICATION #15: F2 - INDOOR/OUTDOOR COMMUNICATION</p>	<p>② CN801 – SPI</p> <p>#1: SGND #3: 12V #2, 4: NC</p>	<p>③ CN310 – 2WIRE SUB</p> <p>#1: 12V #2: COM2_PCTRL_MICOM #3: COM2_VCHECK_A #4: COM2_VCHECK_B #5: COM2_MICOM_AD #6: VCC STANDBY MODE ON/OFF #7: COM2_ENABLE #8: COM2_C #9: COM2_D #10: COM2_TX #11: COM2_RX #12: SGND</p>	<p>④ CN501, 502</p> <p>[CN501] #1, 2: BUZZER #3: CENTER 3 COLOR LED - BLUE #4: CENTER 3 COLOR LED - GREEN #5: CENTER 3 COLOR LED - RED #6: CENTER LED - ICE BLUE #7~10: CENTER LED [CN502] #1: 12V #2~6: VISUALIZATION LED #7~11: REMOTE CONTROL RECEIVER PBA CONNECTION</p>
<p>⑤ CN201 – EEPROM</p> <p>#1: SGND #2: NC #3: 5V #4: EEPROM_SELECT #5: EEPROM_SO #6: EEPROM_SI #7: EEPROM_CLK</p>	<p>⑥ CN81, 83 – AIM-B14</p> <p>[CN81] #1, 3: 12V #2: ERROR CHK (12V JUNCTION) #4: COMP CHK (12V JUNCTION) [CN83] #1: EXT_CTRL (5V) #2: SGND</p>	<p>⑦ CN950 – SUCTION FAN</p> <p>#1, 5, 9: SUCTION VCC (12V) #2, 6, 10: SUCTION FAN F/B #3, 7, 11: SGND #4, 8, 12: SUCTION PWM</p>	<p>⑧ CN412 – INDOOR TEMPERATURE SENSOR</p> <p>#1: ROOMTEMP #2: SGND</p>
<p>⑨ CN230 – DOWNLOAD</p> <p>#1~20: DOWNLOAD</p>	<p>⑩ CN413 – EVA TEMPERATURE SENSOR</p> <p>#1: EVA IN TEMP #3: EVA OUT TEMP #5: DISCHARGE TEMP #2, 4, 6: SGND</p>	<p>⑪ CN411 – FLOAT SW</p> <p>#1: FLOAT SW #2: SGND</p>	<p>⑫ CN802 – DRAIN PUMP</p> <p>#1: DRAIN PUMP (12V) #2: SGND</p>
<p>⑬ CN804 – VENTILATOR</p> <p>#1: VENT (MICOM OUTPUT) #2: BUFFER OUTPUT (HIGH/LOW)</p>			

5-1-5 Indoor Unit Power PCB

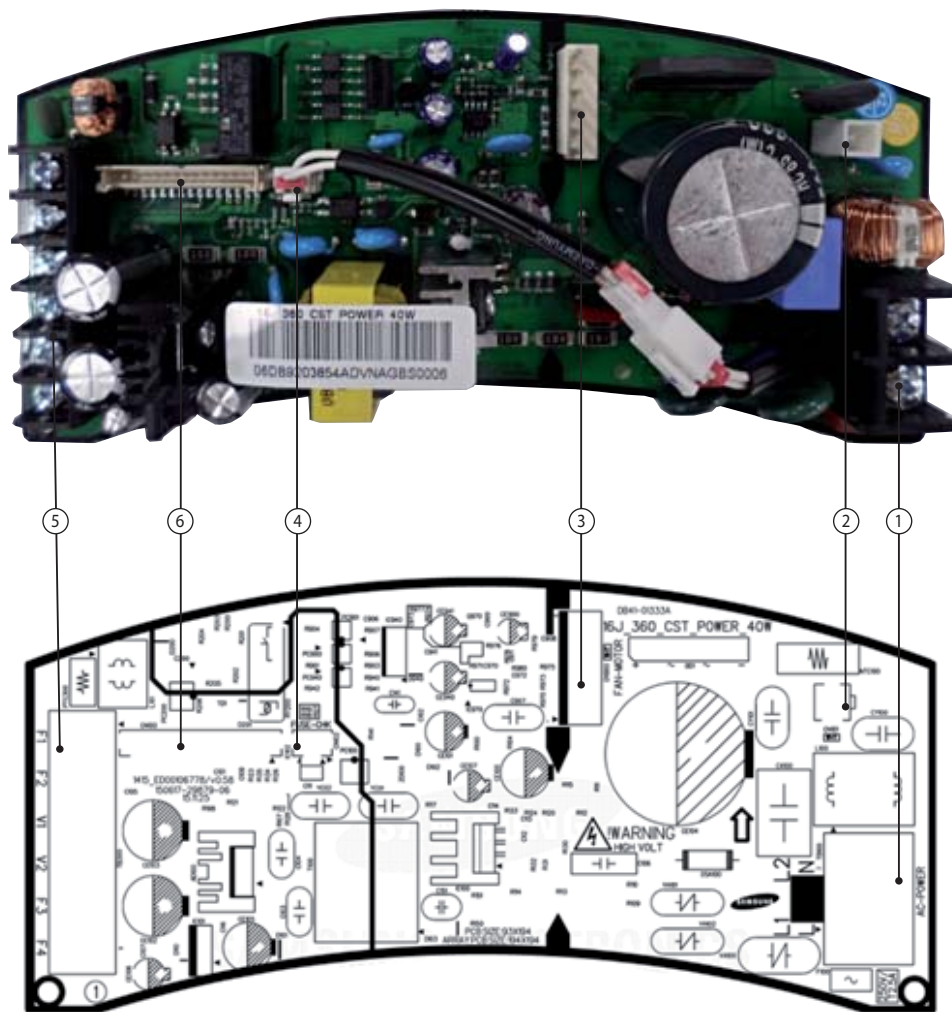

<p>① TB100 - POWER T/B</p> <p>#1 : POWER CORD CONNECTION - L (L1) #2 : POWER CORD CONNECTION - N (L2)</p>	<p>② CN101 - EARTH</p> <p>#1 : EARTH (PBA - SET GND)</p>	<p>③ CN900 - MAIN FAN MOTOR</p> <p>[CN81] #1 : 310V (DC LINK) #2 : NC #3 : PGND #4 : 15V (VCC) #5 : MAIN FAN MOTOR PWM #6 : MAIN FAN MOTOR F/B</p>	<p>④ CN102 - THERMAL FUSE</p> <p>#1 : FUSE SHORT/OPEN CHK #2 : SGND</p>
<p>⑤ TB300 - COMM. T/B</p> <p>#1 : F1 - INDOOR/OUTDOOR COMM. #2 : F2 - INDOOR/OUTDOOR COMM. #3 : V1 - 12V #4 : V2 - SGND #5 : F3 - WIRED REMOTE CONTROL COMM. #6 : F4 - WIRED REMOTE CONTROL COMM.</p>	<p>⑥ CN100 - POWER TO MAIN CONNECTOR</p> <p>[CN81] #1, 3 : 12V #2 : ERROR CHK (12V JUNCTION) #4 : COMP CHK (12V JUNCTION) [CN83] #1 : EXT_CTRL (5V) #2 : SGND</p>		

5-1-6 Display PCB

■ 360 Cassette

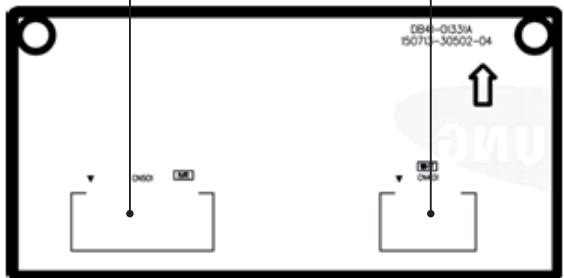
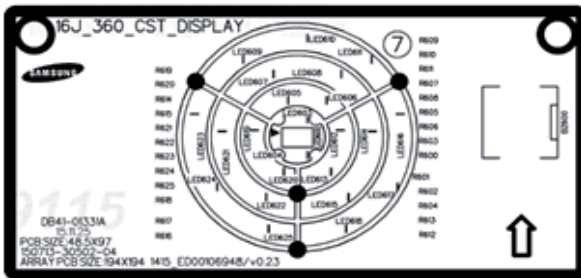

- | | |
|--|--------------------------|
| ① | CN401 – DISPLAY 1 |
| #1 : 12V | |
| #2 : VISUALIZATION LED_SECTION2, LAYER2 | |
| #3 : VISUALIZATION LED_SECTION2, LAYER3 | |
| #4 : VISUALIZATION LED_SECTION3, LAYER1 | |
| #5 : VISUALIZATION LED_SECTION3, LAYER2 | |
| #6 : VISUALIZATION LED_SECTION3, LAYER3 | |
| ② | CN501 – DISPLAY 2 |
| #1 : BUZZER1 | |
| #2 : BUZZER2 | |
| #3 : CENTER 3 COLOR LED - BLUE | |
| #4 : CENTER 3 COLOR LED - GREEN | |
| #5 : CENTER 3 COLOR LED - RED | |
| #6 : CENTER LED - ICE BLUE | |
| #7 : VISUALIZATION LED_SECTION1, LAYER1 | |
| #8 : VISUALIZATION LED_SECTION1, LAYER2 | |
| #9 : VISUALIZATION LED_SECTION1, LAYER3 | |
| #10 : VISUALIZATION LED_SECTION2, LAYER1 | |

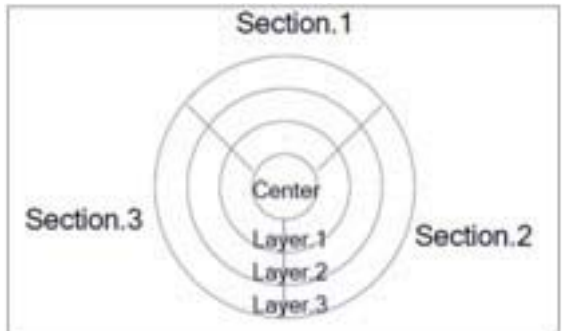

5-1-7 Duct type (Slim Duct 2)

■ MAIN PCB

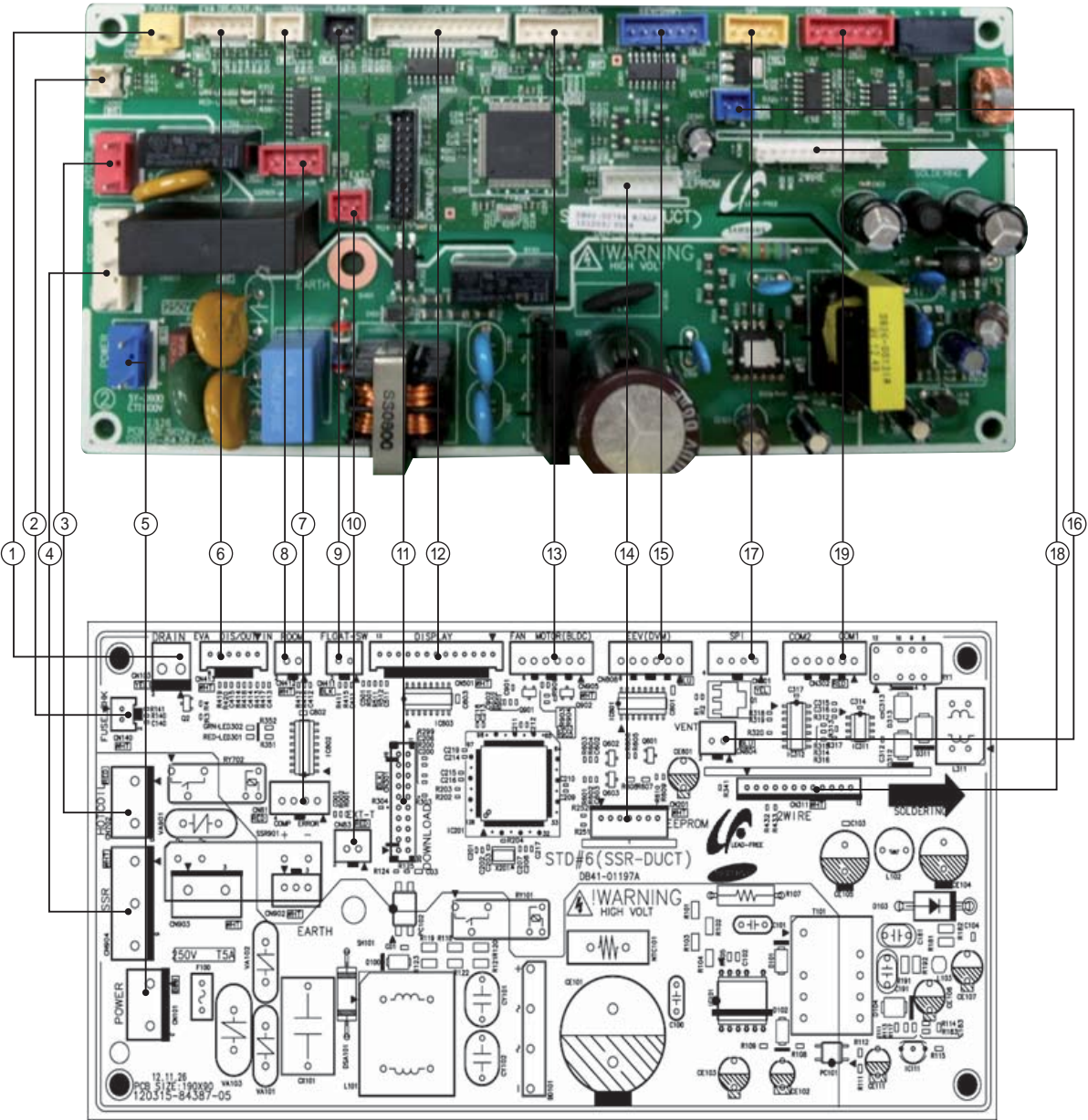

Duct type (Slim Duct 2) (cont.)

■ MAIN PCB

① CN103-DRAIN #1:POWER #2:GND	② CN140-FUSE CHK #1:POWER #2:GND	③ CN702-HOTCOIL #1:N #3:L	④ CN904-SSR #1,#5:N #3:L #2,#4:NO USED
⑤ CN101-POWER #1:L #3:N	⑥ CN413-EVA DIS/OUT/IN #1:EVA-IN #3:EVA-OUT #5:DISCHARGE #2,#4,#6:GND	⑦ CN81-COMP ERROR #1,#3:12V #2:ERROR_CHK_OUT #4:COMP_CHK_OUT	⑧ CN412-ROOM #1:ROOM #2:GND
⑨ CN411-FLOAT SW #1:FLOAT SW #2:GND	⑩ CN83-EXT T #1:GND #2:EXT_CTRL	⑪ CN301-DOWNLOAD - For Developer only,Not available in Actual Site - 20 Pin Down Loader	⑫ CN501-DISPLAY 12.CN501-DISPLAY #1:12V #2~#6:DISPLAY LED CONTROL #7:BZ_1 #8:REMOCON SIGNAL OUT #9:AUTO_SW #10:REMOCON_INT #11:GND #12:VCC #13:BZ_2
⑬ CN905-FAN MOTOR #1:12V #2:GND #3:VCC #4:MOTOR SIGNAL PWM1 OUT #5:R903 CONTROL SIGNAL #6:INRUSH OUT	⑭ CN201-EEPROM #1:GND #2:NO USED #3:VCC #4:EEPROM_SELECT #5:EEPROM_SO #6:EEPROM_SI #7:EEPROM_CLK	⑮ CN808-EEV(DVM) #1~4:CONTROL SIGNAL #5~6:12V	⑯ CN804-VENT #1:12V #2:VENT_OUT
⑰ CN801-SPI #1:GND #2:GND #3:CONTROL SIGNAL #4:NOT USED	⑱ CN311-2WIRE #1:12V #2:COM2_PCTRL_MICOM #3:COM2_VCHECK_A #4:COM2_VCHECK_B #5:COM2_MICOM_AD #6:VCC #7:COM2_ENABLE #8:COM2_C #9:COM2_D #10:COM2_Tx #11:COM2_Rx #12:GND	⑲ CN302-COM1 COM2 #1~2:COM1 #3:12V #4:GND #5~6:COM2	

Duct type (Slim Duct 2) (cont.)

■ Sub PCB

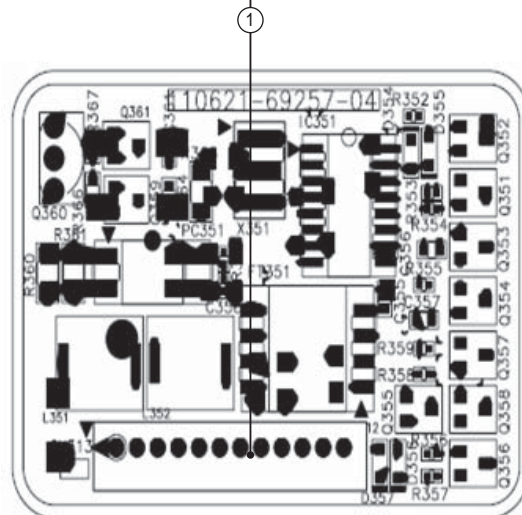

① CN313-2WIRES COMM.

- #1:12V
- #2:COM2_PCTRL_MICOM
- #3:COM2_VCHECK_A
- #4:COM2_VCHECK_B
- #5:COM2_MICOM_AD
- #6:VCC
- #7:NO UESD
- #8:COM2_C
- #9:COM2_D
- #10:COM2_TXD
- #11:COM2_RXD
- #12:GND

5-1-8 Duct type (Slim Duct 3)

■ MAIN PCB

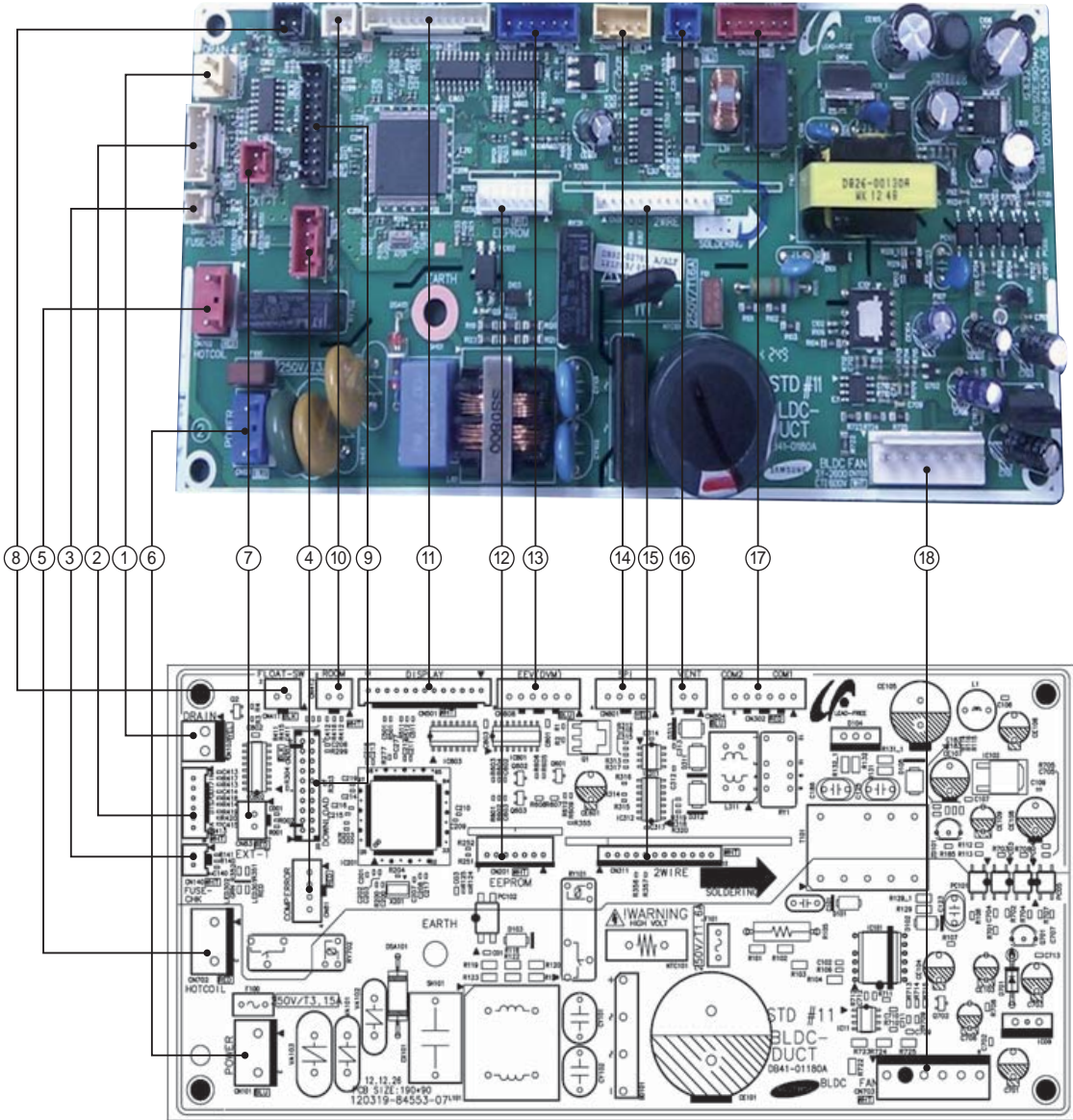

Duct type (Slim Duct 3) (cont.)

■ MAIN PCB

① CN103-DRAIN #1:POWER #2:GND	② CN413-EVA DIS/OUT/IN #1:EVA-IN #3:EVA-OUT #5:DISCHARGE #2,#4,#6:GND	③ CN140-FUSE CHK #1:POWER #2:GND	④ CN81-COMP ERROR #1,#3:12V #2:ERROR_CHK_OUT #4:COMP_CHK_OUT
⑤ CN702-HOTCOIL #1:N #3:L	⑥ CN101-POWER #1:L #3:N	⑦ CN83-EXT T #1:GND #2:EXT_CTRL	⑧ CN411-FLOAT SW #1:FLOAT SW #2:GND
⑨ CN301-DOWNLOAD →For Developer only,Not available in Actual Site →20 Pin Down Loader	⑩ CN412-ROOM #1:ROOM #2:GND	⑪ CN501-DISPLAY #1:12V #2~#6:DISPLAY LED CONTROL #7:BZ_1 #8:REMOCON SIGNAL OUT #9:AUTO_SW #10:REMOCON_INT #11:GND #12:VCC #13:BZ_2	⑫ CN201-EEPROM #1:GND #2:NO USED #3:VCC #4:EEPROM_SELECT #5:EEPROM_SO #6:EEPROM_SI #7:EEPROM_CLK
⑬ CN808-EEV(DVM) #1~4:CONTROL SIGNAL #5~6:12V	⑭ CN801-SPI #1:GND #2:GND #3:CONTROL SIGNAL #4:NOT USED	⑮ CN311-2WIRE #1:12V #2:COM2_PCTRL_MICOM #3:COM2_VC_CHECK_A #4:COM2_VC_CHECK_B #5:COM2_MICOM_AD #6:VCC #7:COM2_ENABLE #8:COM2_C #9:COM2_D #10:COM2_Tx #11:COM2_Rx #12:GND	⑯ CN804-VENT #1:12V #2:VENT_OUT
⑰ CN302-COM1 COM2 #1~2:COM1 #3:12V #4:GND #5~6:COM2	⑱ CN703-BLDC FAN #1:DC310V #2:NOT USED #3:AGND #4:DC15V #5:PC04 OUTPUT #6:RPM OUTPUT		

Duct type (Slim Duct 3) (cont.)

■ Sub PCB

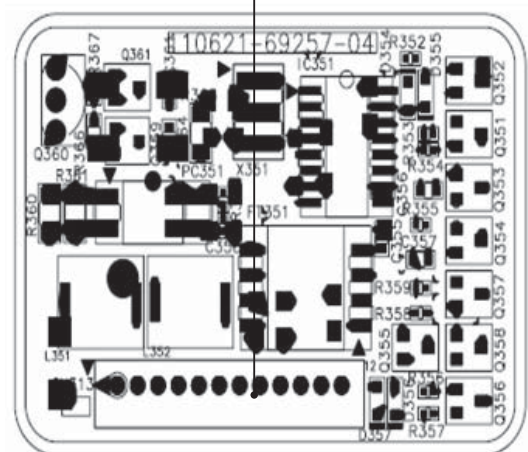

① **CN313-2WIRES COMM.**

- #1:12V
- #2:COM2_PCTRL_MICOM
- #3:COM2_VCHECK_A
- #4:COM2_VCHECK_B
- #5:COM2_MICOM_AD
- #6:VCC
- #7:NO UESD
- #8:COM2_C
- #9:COM2_D
- #10:COM2_TXD
- #11:COM2_RXD
- #12:GND

5-1-9 Duct type(MSP, HSP, Big Duct)

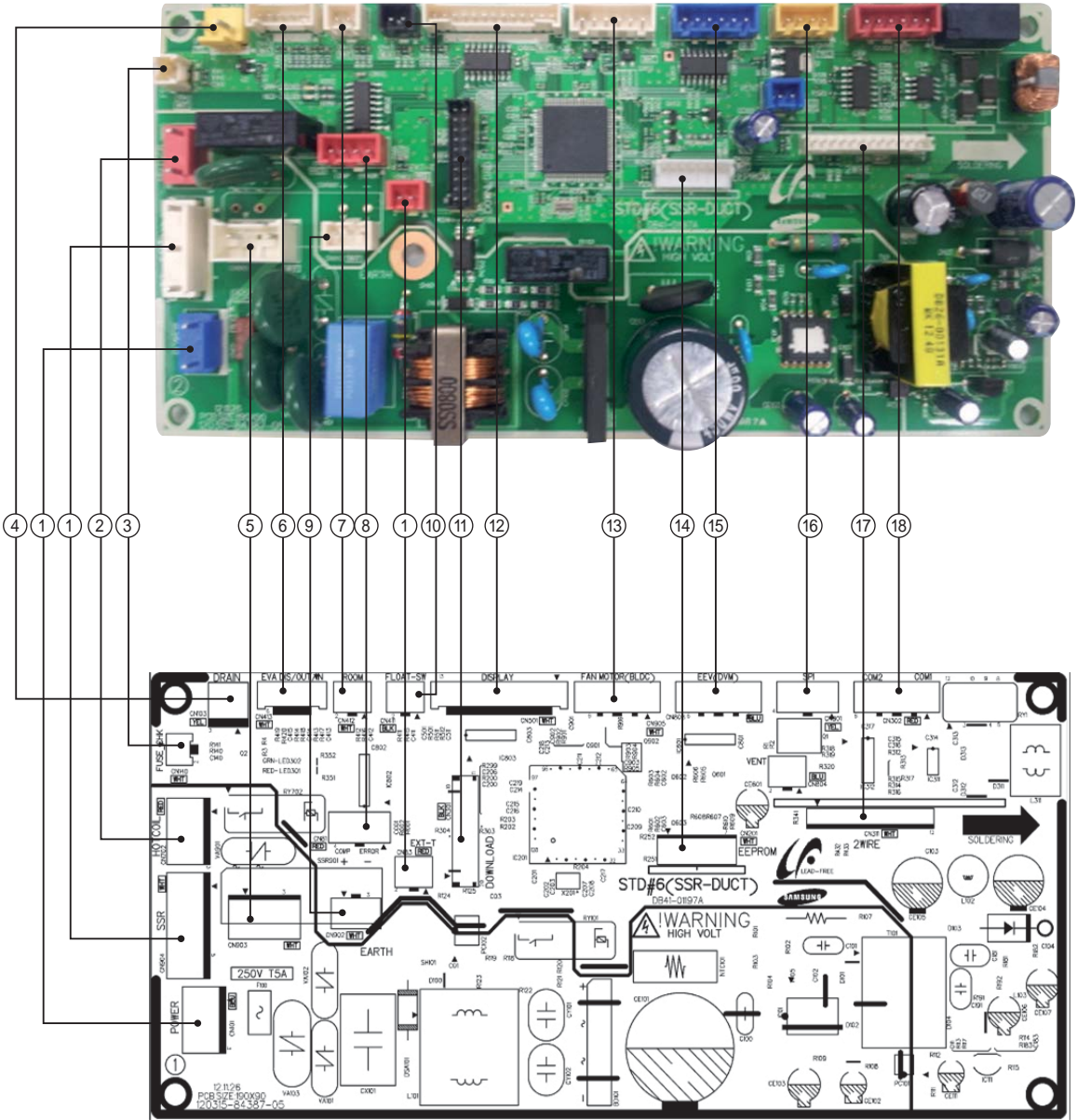

Duct type(MSP, HSP, Big Duct) (cont.)

<p>① CN904-SSR MOTOR #1: N #2: L #3: N</p>	<p>② CN702-HOT COIL #1: L #2: N</p>	<p>③ CN140-FUSE CHECK #1:FUSE CHECK #2:GND</p>	<p>④ CN103-DRAIN PUMP #1: 12V #2 : GND</p>
<p>⑤ CN903-SSR AC 제어 #1: L Input #2: L Output</p>	<p>⑥ CN413- 온도 센서 #1 : EVA IN TEMP #2,4,6: GND #3 : EVA OUT TEMP #5 : DISCHARGE TEMP</p>	<p>⑦ CN412-ROOM 온도센서 #1: 온도 입력 #2: GND</p>	<p>⑧ CN81-EXTERNAL CONTROL OUT #1,3: 12V #2: ERROR CHECK OUT #4: COM CHK OUT</p>
<p>⑨ CN902- SSR DC 출력 #1: 12V #2: MOTOR SSR OUT</p>	<p>⑩ CN83-EXTERNAL CONTROL #1: GND #2: EXT CTRL</p>	<p>⑪ CN301-MICOM DOWNLOAD</p>	<p>⑫ CN501-DISPLAY #1:12V #2~6:LED 제어 #7: BZ1 #8: 리모컨 신호 출력 #9: AUTO SW #10: REMOCON INT #11:GND #12:VCC #13:BZ2</p>
<p>⑬ CN905-BLDC MOTOR #1:12V #2: GND #3: VCC #4: MOTOR SIGNAL PWM #5: MOTOR FEEDBACK #6:INRUSH OUT #12:VCC</p>	<p>⑭ CN201-E2P 모듈</p>	<p>⑮ CN808- 전동변 #1~4: 전동변 제어 #5,6: 12V</p>	<p>⑯ CN801-SPI #1,2:GND #3:SPI 제어</p>
<p>⑰ CN311-2 선 통신</p>	<p>⑱ CN302-실내외기 통신 / 유선 #1,2:실내외기 통신 #3:12V #4:GND #5:유선리모컨 통신</p>	<p>⑲ CN101-AC INPUT #1: L #2: N</p>	

5-1-10 Duct type(HSP)

■ BLDC PCB

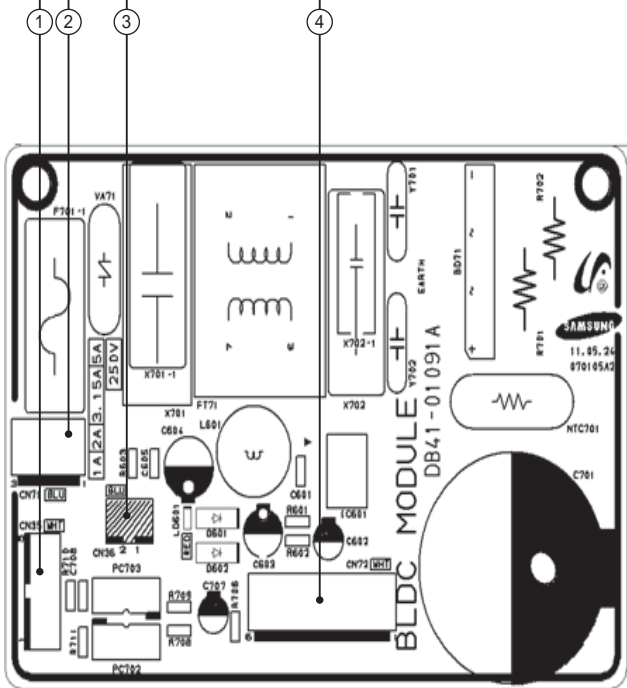

Duct type(HSP) (cont.)

■ BLDC PCB

<p>① CN35-Main PCB Connection</p> <p>#1: DC12V #2: Fan Signal #3: DC5V #4: Fan feedback signal #5: GND</p>	<p>② CN71-AC Power</p> <p>#1: AC power L #2: AC power N</p>	<p>③ CN36-BLDC PCB Connection</p> <p>#1: DC12V #2: Fan signal</p>	<p>④ CN12-Motor Connector</p> <p>#1: DC310V #3: GND #4: DC15V #5: Fan signal #6: Fan feedback signal</p>
---	---	---	---

5-1-11 Duct type (Super)

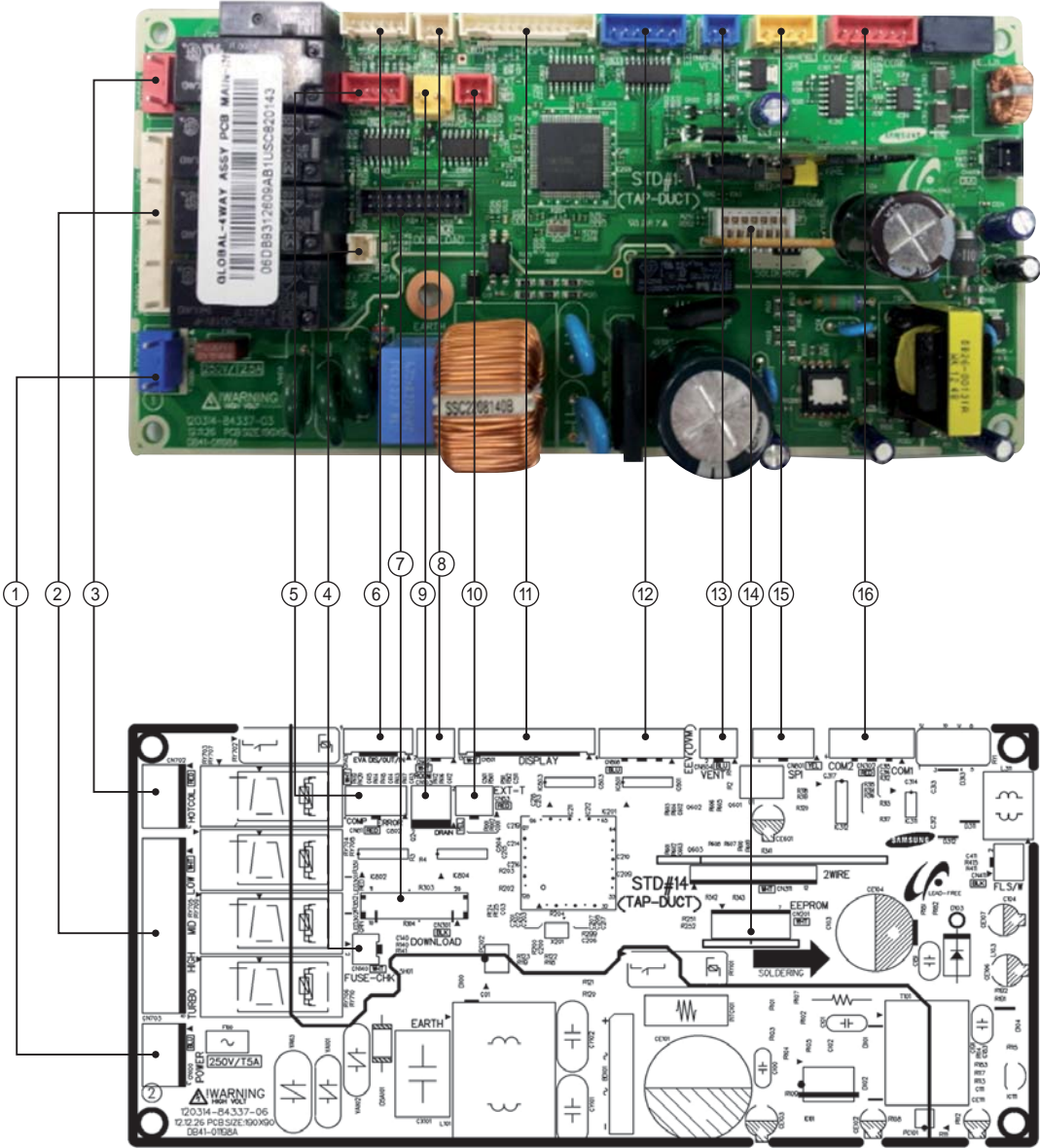

Duct type (Super) (cont.)

<p>① CN100-POWER</p> <p>#1: LIVE #2: - #3: NEUTRAL</p>	<p>② CN703-FAN STEP</p> <p>#1: NEUTRAL #2: - #3: FAN_LOW_OUT #4: - #5: FAN_MID_OUT #6: - #7: FAN_HUGH_OUT #8: - #9: FAN_TURBO_OUT</p>	<p>③ CN702-HOT COIL</p> <p>#1: NEUTRAL #2: LIVE</p>	<p>④ CN140-FUSE CHECKER</p>
<p>⑤ CN81-ERROR/COMP CHECK</p> <p>#1: 12V #2: ERROR_CHK_OUT #3: 12V #4: COMP_CHK_OUT</p>	<p>⑥ CN413-EVA IN/EVA OUT/ DISCHARGE TEMP</p> <p>#1: EVA-IN #2: EVA-IN #3: EVA-OUT #4: EVA-OUT #5: DISCHARGE #6: DISCHARGE</p>	<p>⑦ CN301-DOWNLOAD</p>	<p>⑧ CN412-ROOM TEMP</p> <p>#1: ROOM TEMP #2: ROOM TEMP</p>
<p>⑨ CN103-DC DRAIN PUMP</p> <p>#1: DRAIN_PUMP_OUT #2: GND</p>	<p>⑩ CN83-EXT_CONTROL</p>	<p>⑪ CN501-DISPLAY</p> <p>#1: 12V #2: LED_0_OUT #3: LED_1_OUT #4: LED_2_OUT #5: LED_3_OUT #6: LED_4_OUT #7: BZ_1 #8: REMOCON_SIGN_OUT #9: AUTO_SW #10: REMOCON_INT #11: GND #12: 5V #13: BZ_2</p>	<p>⑫ CN808-EEV(DVM)</p> <p>#1: EEV'_B_OUT #2: EEV'_A_OUT #3: EEV_B_OUT #4: EEV_A_OUT #5: 12V #6: 12V</p>
<p>⑬ CN804-VENTILATOR</p> <p>#1: 12V #2: VENT_OUT</p>	<p>⑭ CN201-EEPROM</p>	<p>⑮ CN801-SPI</p> <p>#1: GND #2: GND #3: SPL_CTRL_OUT_1 #4: -</p>	<p>⑯ CN302-COM1/COM2</p> <p>#1: COM1_A #2: COM1_B #3: 12V #4: GND #5: COM2_C #6: COM2_D</p>

5-1-12 Ceiling type

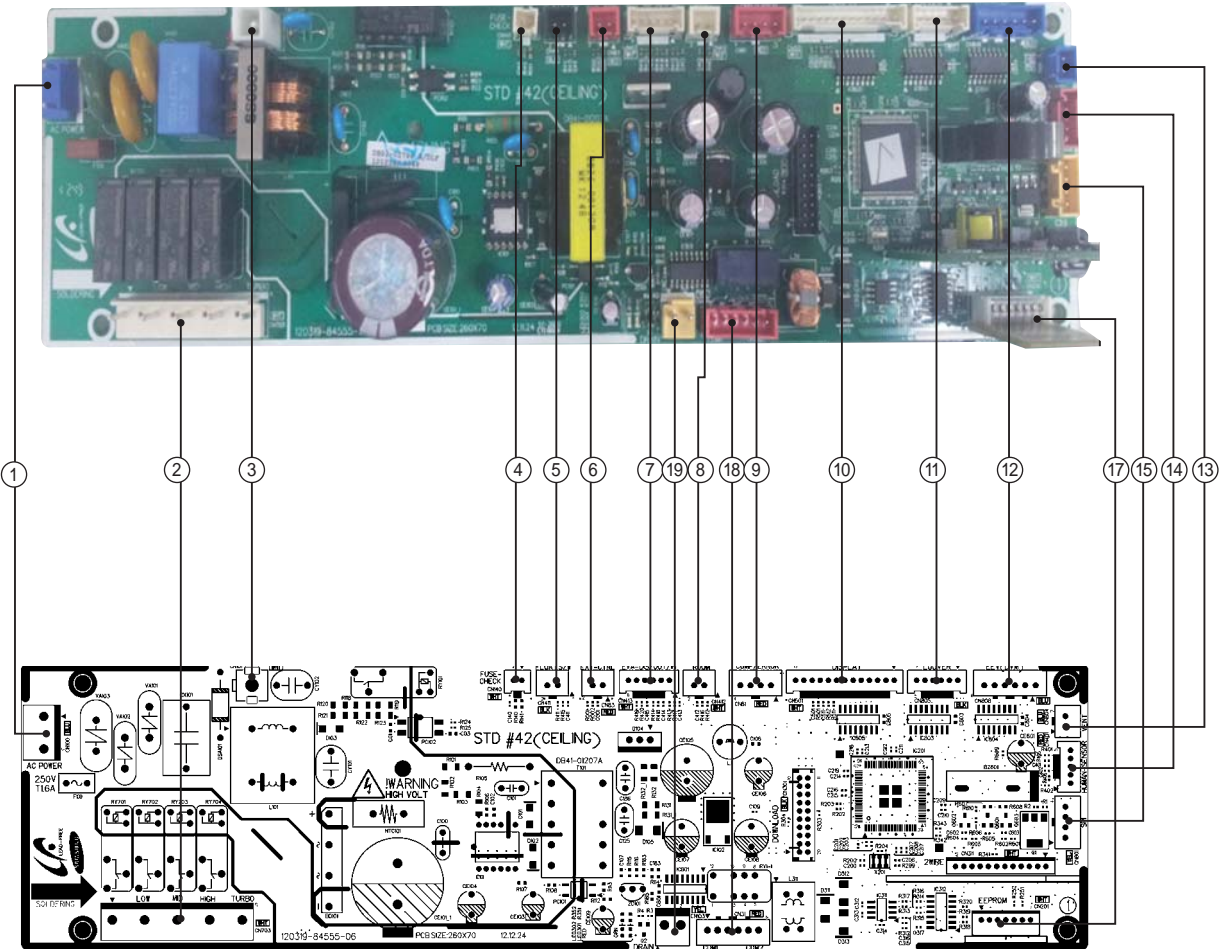

Celing type (cont.)

① CN100-VENTILATOR #1: L #3: N	② CN703-FAN MOTOR #1: N #3: RY701 OUTPUT #5: RY702 OUTPUT #7: RY703 OUTPUT #9: RY704 OUTPUT	③ CN101-GND #1: GND	④ CN140-FUSE CHECK #1: FUSE CHECK #2: GND
⑤ CN411-FLOAT S/W #1: FLOAT_SW #2: GND	⑥ CN83-EXT CTRL #1: GND #2: EXT_CTRL	⑦ CN413-EVA-DIS/OUT/IN #1: VEA_IN_MID_TEMP #2: GND #3: EVA_OUT_TEMP #4: GND #5: EVA_DIS_TEMP #6: GND	⑧ CN412-ROOM #1: ROOM_TEMP #2: GND
⑨ CN81-COMP/ERROR #1: DC 12V #2: ERROR_CHK_OUT #3: DC 12V #4: COMP_CHK_OUT	⑩ CN501-DISPLAY #1: DC 12V #2~#7: LED SIGNAL #8: REMOCON_SIGN_OUT #9: AUTO_SW #10: REMOCON_INT #11: GND #12: DC 5V #13: NOT USED	⑪ CN805-LOUVER #1: DC 12V #2: DC 12V #3~#6: LVR SIGNAL	⑫ CN808-EEV(DVM) #1~#4: EEV SIGNAL #5: DC 12V #6: DC 12V
⑬ CN804-VENT #1: DC 12V #2: VENT_OUT	⑭ CN401-HUMAN_SENSOR #1: DC 12V #2: COM4_TXD #3: COM4_RXD #4: NOT USED #5: GND	⑮ CN801-SPI #1: GND #2: GND #3: Q1_OUT #4: NOT USED	⑯ CN311-2WIRE OPTION #1:DC12V #2~#5:COMM. SIGNAL #6:VCC(DC5V) #7~#11:COMM. SIGNAL #12:GND
⑰ CN201-EEPROM #1:GND #2:NOT USED #3:VCC(DC5V) #4~#7:EEPROM SIGNAL	⑱ CN31-HUMAN_SENSOR #1~#2: COM1 SIGNAL #3: DC12V #4: GND #5~#6: COM2 SIGNAL	⑲ CN103-DRAIN #1: DRAIN SIGNAL #2: GND	

5-1-13 Console

■ MAIN PCB

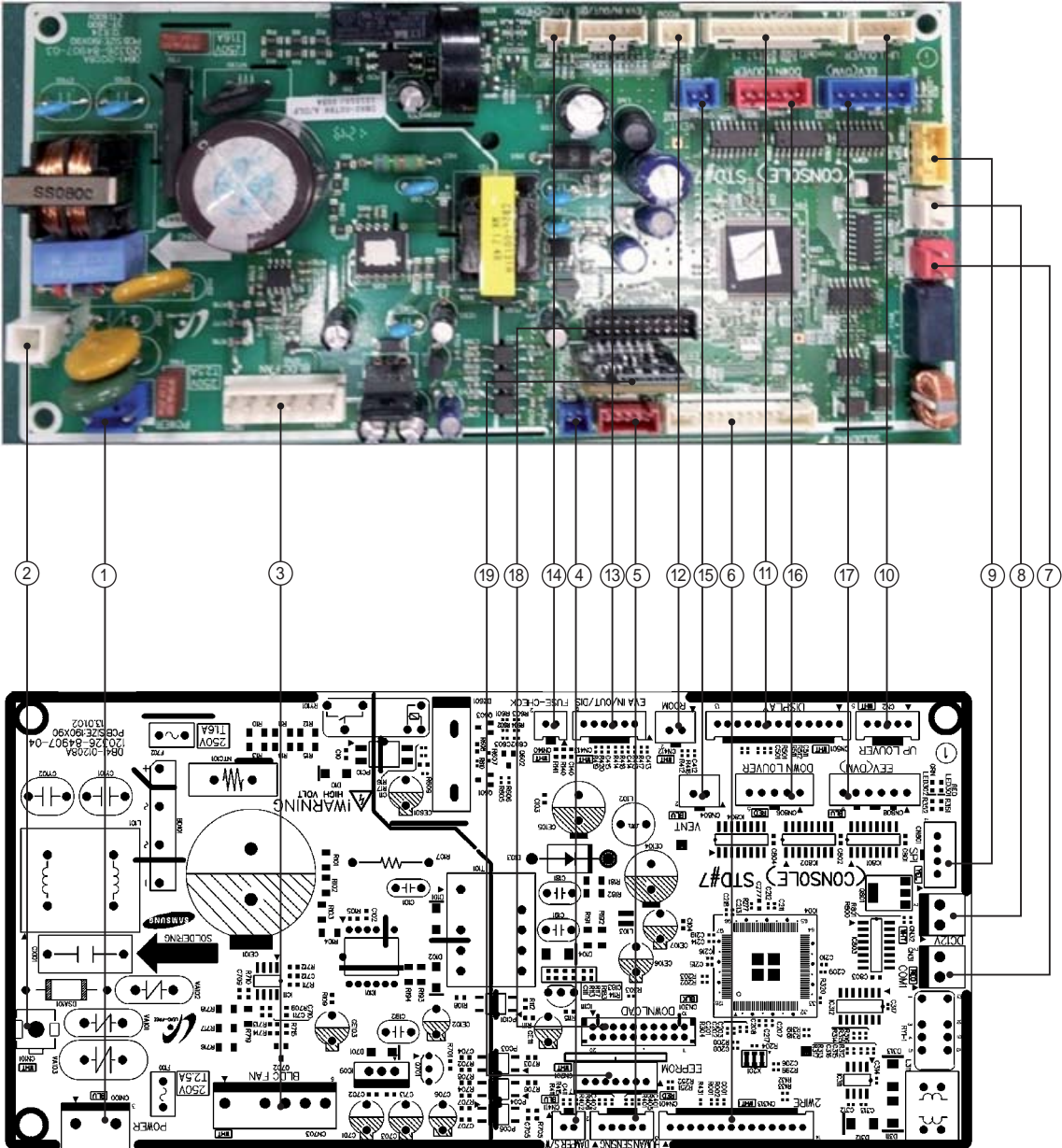

Console (cont.)

■ MAIN PCB(cont.)

① CN100-AC POWER #1: L #3: N	② CN101-GND #1: GND	③ CN703-FAN MOTOR #1:DC310V #2:NOT USED #3:AGND #4:DC15V #5:PC04 OUTPUT #6:RPM OUTPUT	④ CN411-FLOAT S/W #1:FLOAT S/W #2:GND
⑤ CN401-HUMAN SENSING #1:DC12V #2,#3:COMM. SIGNAL #4:NOT USED #5:GND	⑥ CN313-2WIRES COMM. #1~#4:COMM. SIGNAL #5:EXTERNAL CONTROL #6:COMP CHECK #7:ERROR CHECK #8:VCC(DC5V) #9:GND #10:DC12V #11~#14:COMM. SIGNAL	⑦ CN31-COMM.1 #1:COMM. SIGNAL F1 #2:COMM. SIGNAL F2	⑧ CN32-DC12V #1:DC12V #2:GND
⑨ CN801-SPI #1:GND #2:GND #3:CONTROL SIGNAL #4:NOT USED	⑩ CN2-UP LOUVER #1:DC12V #2~#5:CONTROL SIGNAL	⑪ CN501-DISPLAY #1:DC12V #2~#6:DISPLAY LED CONTROL #7:VCC(DC5V) #8:REMOCON SIGNAL OUT #9:TOUCH SWITCH SIGNAL #10:REMOCON SIGNAL IN #11:GND #12:VCC(DC5V) #13:NOT USED	⑫ CN412-ROOM SENSOR #1:ROOM TEMP. SENSOR #2:GND
⑬ CN413-EVA IN/OUT #1:EVA IN/OUT TEMP. SENSOR #2:GND	⑭ CN140-FUSE CHECK #1:FUSE CHECK SIGNAL #2:GND	⑮ CN804-VENT #1:DC12V #2:VENT SIGNAL	⑯ CN806-DOWN LOUVER #2~#5:CONTROL SIGNAL
⑰ CN808-EEV #1~#4:EEV CONTROL SIGNAL #5,#6:DC12V	⑱ CN301-DOWNLOAD →For Developer only,Not available in Actual Site →20 Pin Down Loader	⑲ CN201-EEPROM PBA CONNECTOR #1:GND #2:NOT USED #3~#7:EEPROM SIGNAL	

Console (cont.)

■ Sub PCB



①

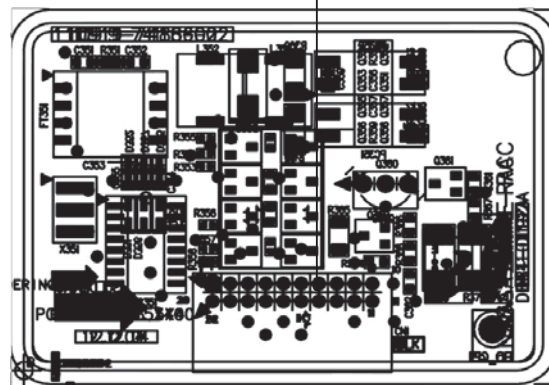

① CN1-2WIRES COMM.

#1,#2,#19,#20:COMM. SIGNAL
 #3,#18:EXTERNAL CONTROL
 #4,#17:COMP CHECK
 #5,#16:ERROR CHECK
 #6:VCC(DC5V)
 #7,#14:GND
 #8,#13,#15:DC12V
 #9~#12:COMM. SIGNAL

Console(cont.)

■ DISPLAY

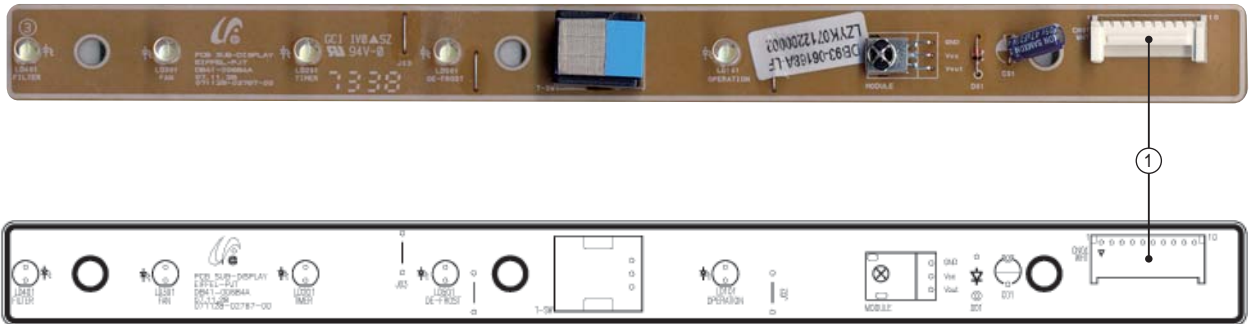

DC Connector	① CN01-Panel Display
	#1,#2,#3,#4,#5: Display LED Control #6: TOUCH S/W Reset(DC5V) #7: TOUCH S/W out(DC5V) #8: Receive REMOCON Signal #9: GND #10: VCC(DC5V)

■ DAMPER

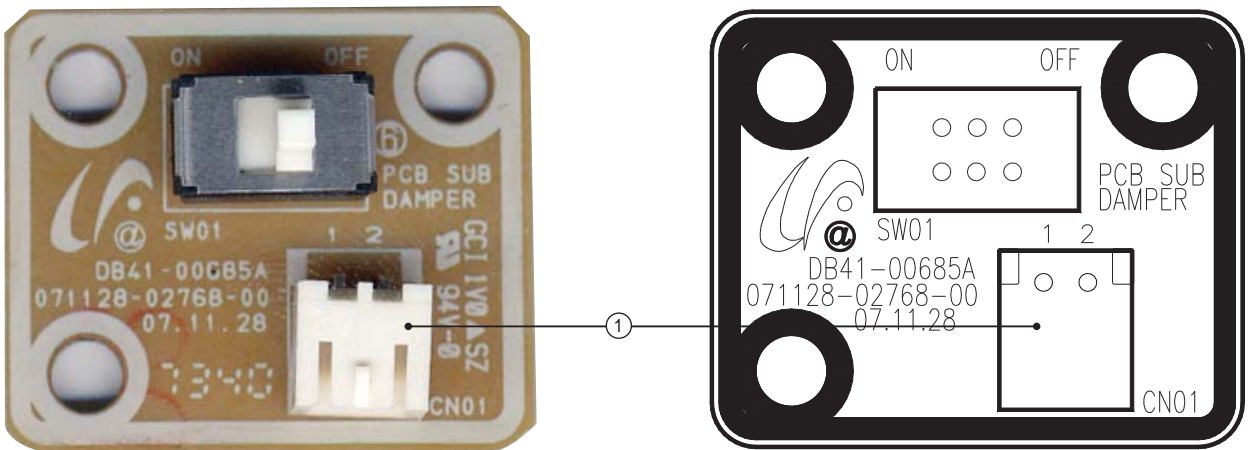

DC Connector	① CN01-Damper S/W
	#1: DC5V #2: GND

5-1-14 Wall-Mounted type (Neo Forte)

■ MAIN

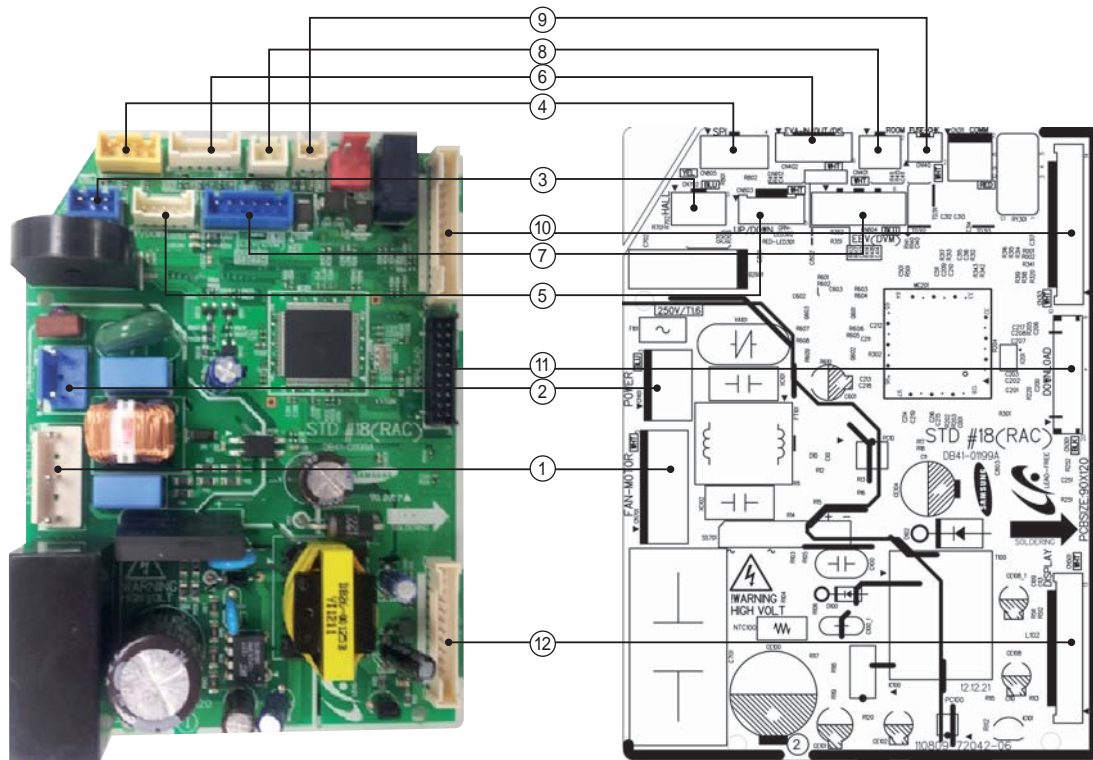

<p>① CN701-SSR MOTOR #1: 12V #2: MOTOR SSR OUT</p>	<p>② CN101-AC INPUT #1: L #2: N</p>	<p>③ CN702-HALL IC 입력 #1: VCC #2: GND #3: Hall Sensor 값 입력</p>	<p>④ CN805-SPI #1~2: GND #3: SPI 제어</p>
<p>⑤ CN803- 상하 블레이드 #1: VCC #2~5: 블레이드 제어</p>	<p>⑥ CN402-온도 센서 #1: EVA IN TEMP #2,4,6: GND #3: EVA OUT TEMP #5: DISCHARGE TEMP</p>	<p>⑦ CN804- 전동변 #1~4: 전동변 제어 #5,6: 12V</p>	<p>⑧ CN401-ROOM 온도센서 #1: 온도 입력 #2: GND</p>
<p>⑨ CN140 - FUSE Check #1:FUSE CHECK #2:GND</p>	<p>⑩ CN313-2 선통신</p>	<p>⑪ CN301-MICOM DOWNLOAD</p>	<p>⑫ CN501-DISPLAY #1:12V #2~7:LED 제어 #8: 리모컨 신호 출력 #9: AUTO SW #10: REMOCON INT #11:GND #12:VCC</p>

Wall-Mounted type (Neo Forte)(cont.)

■ SUB SWITCH

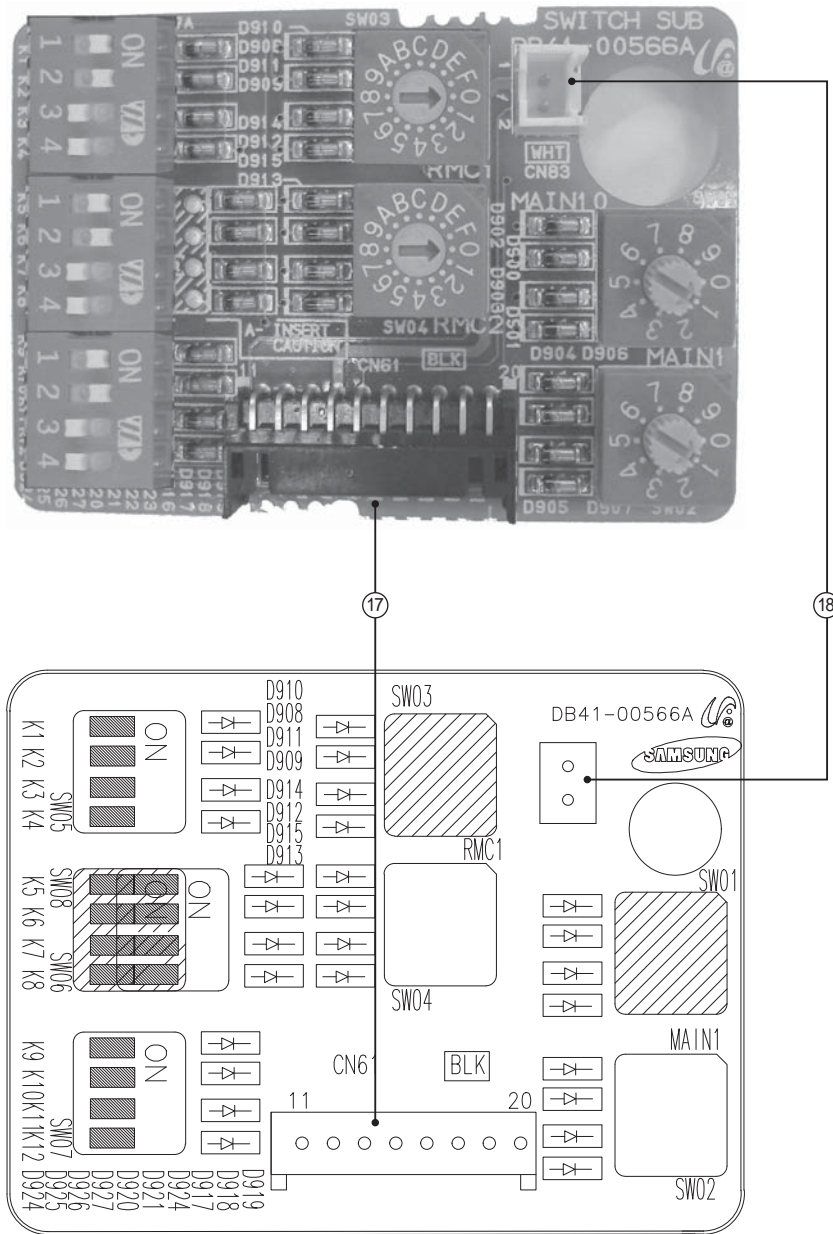

No.	CN #	COLOR	FUNCTION
⑰	CN61	Black	Main-Sub PCB Connector
⑱	CN83	White	External Contact Control

5-1-15 Wall Mounted type(A3050)

■ MAIN

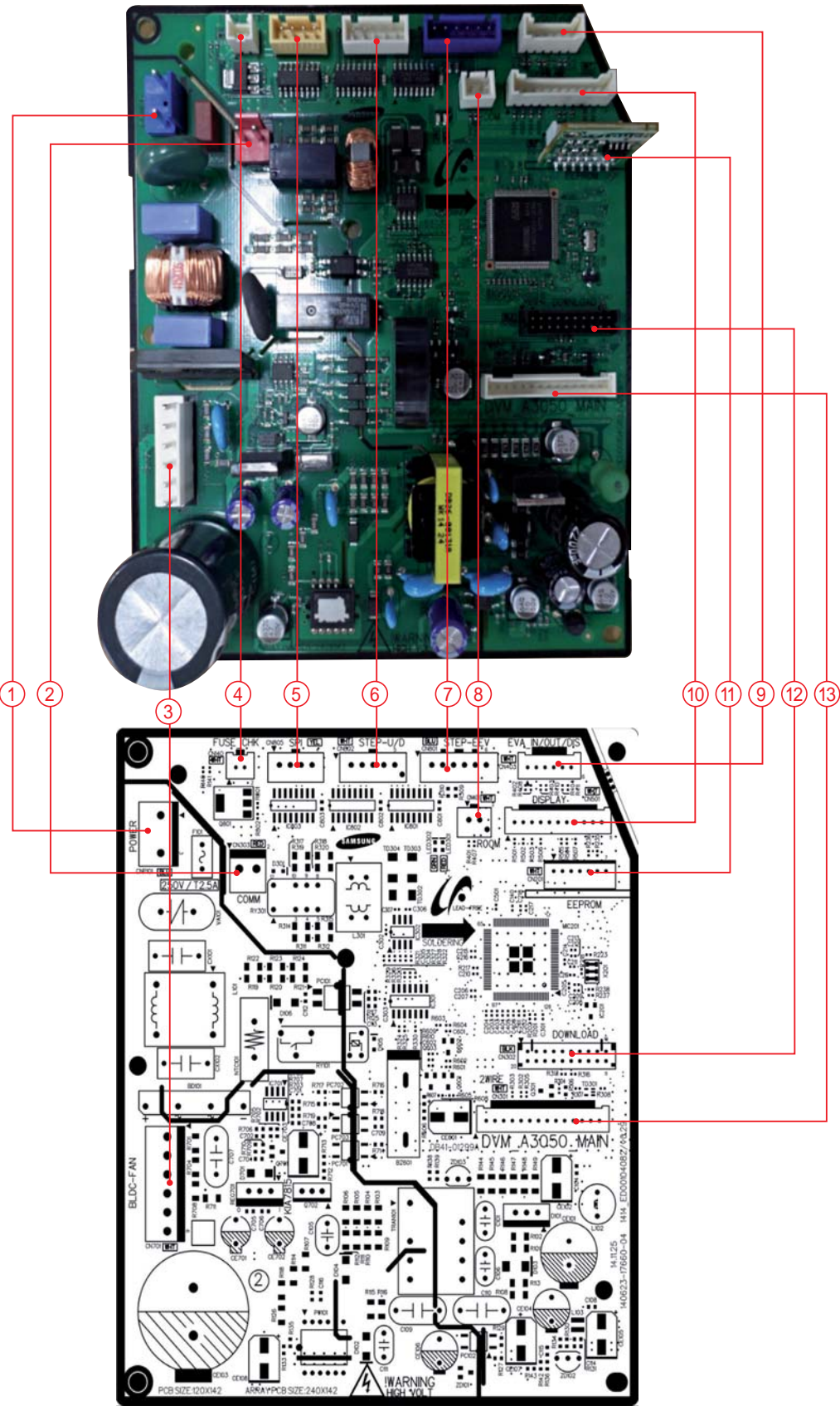

Wall Mounted type(A3050) (cont.)

<p>① CNP101-POWER #1 : L #2 : NOT USED #3 : N</p>	<p>② CN303-COM1 #1~2 : COMMUNICATION SIGNAL</p>	<p>③ CN701-BLDC FAN #1 : DC 310V #2 : NOT USED #3 : GND #4 : PWM SIGNAL #5 : FEEDBACK SIGNAL</p>	<p>④ CN140-FUSE CHECK #1 : THERMAL FUSE SIGNAL #2 : GND</p>
<p>⑤ CN805-SPI #1~2 : GND #3 : SPI CONTROL SIGNAL #4 : NOT USED</p>	<p>⑥ CN802-STEP UP/DOWN #1 : DC 12V #2~5 : LOUVER SIGNAL</p>	<p>⑦ CN801-EEV #1~4 : EEV SIGNAL #5~6 : DC 12V</p>	<p>⑧ CN401-ROOM #1 : OOM TEMPERATURE SENSOR SIGNAL #2 : GND</p>
<p>⑨ CN403-EVA IN/OUT/DIS #1 : EVA IN TEMPERATURE SENSOR SIGNAL #2 : GND #3 : EVA OUT TEMPERATURE SENSOR SIGNAL #4 : GND #5 : DISCHARGE TEMPERATURE SENSOR SIGNAL #6 : GND</p>	<p>⑩ CN501-DISPLAY #1~3 : LED SIGNAL #4 : REMOCON SIGNAL #5 : GND #6 : DC 5V #7~8 : REMOCON SIGNAL #9~11 : NOT USED</p>	<p>⑪ CN201-EEPROM #1 : GND #2 : NOT USED #3 : DC 5V #4~7 : EEPROM SIGNAL</p>	<p>⑫ CN302-DOWNLOAD #1~8 : DOWNLOAD SIGNAL #9 : GND #10~11 : DC 5V #12~16 : DOWNLOAD SIGNAL #17 : GND #18~20 : DOWNLOAD SIGNAL</p>
<p>⑬ CN301-to 2WIRE SUB #1~2 : COMMUNICATION SIGNAL #3~4 : SUB PBA SIGNAL #5 : EXTERNAL CONTROL SIGNAL #6 : COMP CHECK SIGNAL #7 : ERROR CHECK SIGNAL #8 : DC 5V #9 : GND #10 : DC 12V #11~14 : COMMUNICATION SIGNAL</p>			

Wall Mounted type(A3050) (cont.)

■ Sub PCB

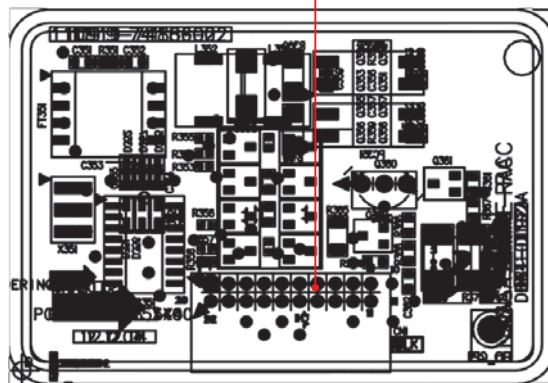
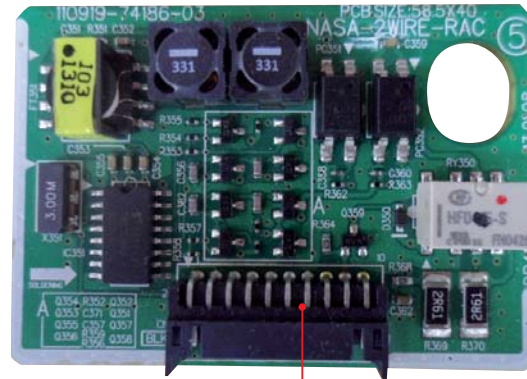

① CN1-2WIRES COMM.

- #1,#2,#19,#20:COMM. SIGNAL
- #3,#18:EXTERNAL CONTROL
- #4,#17:COMP CHECK
- #5,#16:ERROR CHECK
- #6:VCC(DC5V)
- #7,#14:GND
- #8,#13,#15:DC12V
- #9~#12:COMM. SIGNAL

5-1-16 ERV Plus

■ MAIN

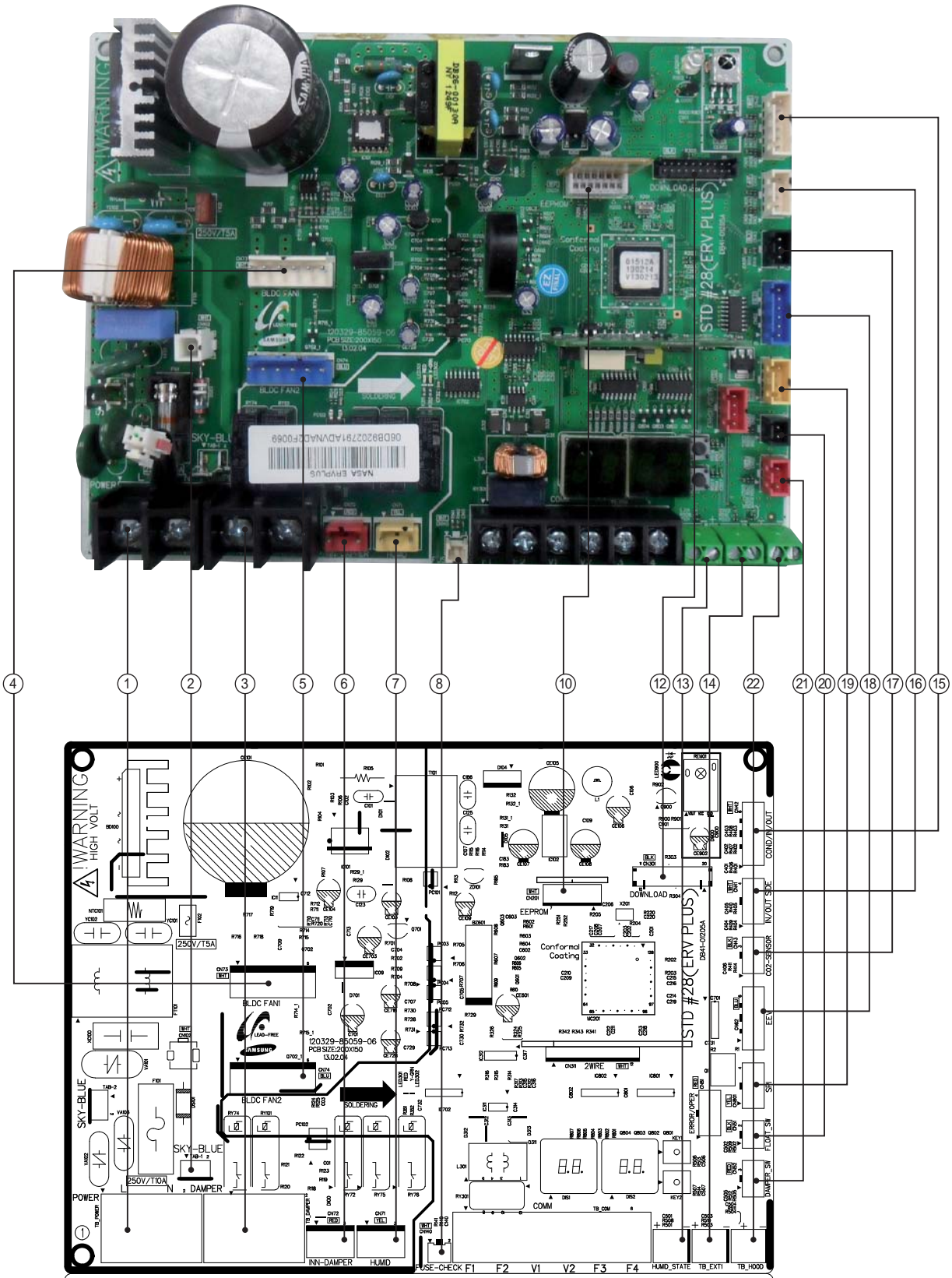

ERV Plus(cont.)

① TB_POWER-AC POWER #1: POWER(L) #2: POWER(N)	② CN102-GND #1 : GND	③ TB_DAMPER #1: DEMPER AC(L) #2: DEMPER AC(N)	④ CN73-BLDC MOTER1 #1: DC310V #3 : GND #4 : DC15V #5 : FAN RPM #6 : RPM FEEDBACK
⑤ CN74-BLDC MOTER2 #1: DC310V #3 : GND #4 : DC15V #5 : FAN RPM #6 : RPM FEEDBACK	⑥ CN72-INNER DAMPER #1: INNER DEMPER AC(L) #2: INNER DEMPER AC(N)	⑦ CN71-HUMID #1: HUMID AC(L) #2: HUMID AC(N)	⑧ CN140-FUSE CHECK #1: FUSE CHECK SIGNAL #2: GND
⑨ TB_COM-COMMUNICATION #1: COM1(F1) #2: COM1(F2) #3: V1(DC12V) #4: V2(GND) #5: COM2(F3) #6: COM2(F4)	⑩ CN201-EEPROM #1: GND #3: DC5V #4: EEPROM_SELECT #5: EEPROM_SO #6: EEPROM_SI #7: EEPROM_CLK	⑪ CN311-2WIRED REMOCOON	⑫ CN301-DOWNLOAD
⑬ HUMID_STATE-HUMID STATE #1 : HUMID STEAT signal #2 : GND	⑭ TB_EXT1-EXT CONTROL #1 : EXT CONTROL signal #2 : GND	⑮ CN42-COND,EVA_IN/OUT SENSOR #1 #2: GND #3: EVA IN SENSOR #4: GND #5: EVA OUT SENSOR #6: GND	⑯ CN41-IN/OUT_SIDE SENSOR #1 : IN SIDE SENSOR #2 : GND #3 : OUT SIDE SENSOR #4 : GND
⑰ CN43-CO2 SENSOR #1 : DC 12V #2 : CO2 SENSOR #3 : GND	⑱ CN62-EEV #1~#4: EEV signal #5 : DC12V #6 : DC12V	⑲ CN801-SPI #1: GND #2: GND #3: SPI POWER OUTPUT(DC12V)	⑳ CN51-FLOAT SWITCH #1: FLOAT SWITCH signal #2: GND
㉑ CN52-DAMPER SWITCH #1 : DAMPER SWITCH signal #3 : GND	㉒ TB_HOOD-HOOD #1 : HOOD signal #2 : GND		

5-1-17 GD-S (Big Duct)

- Main PBA

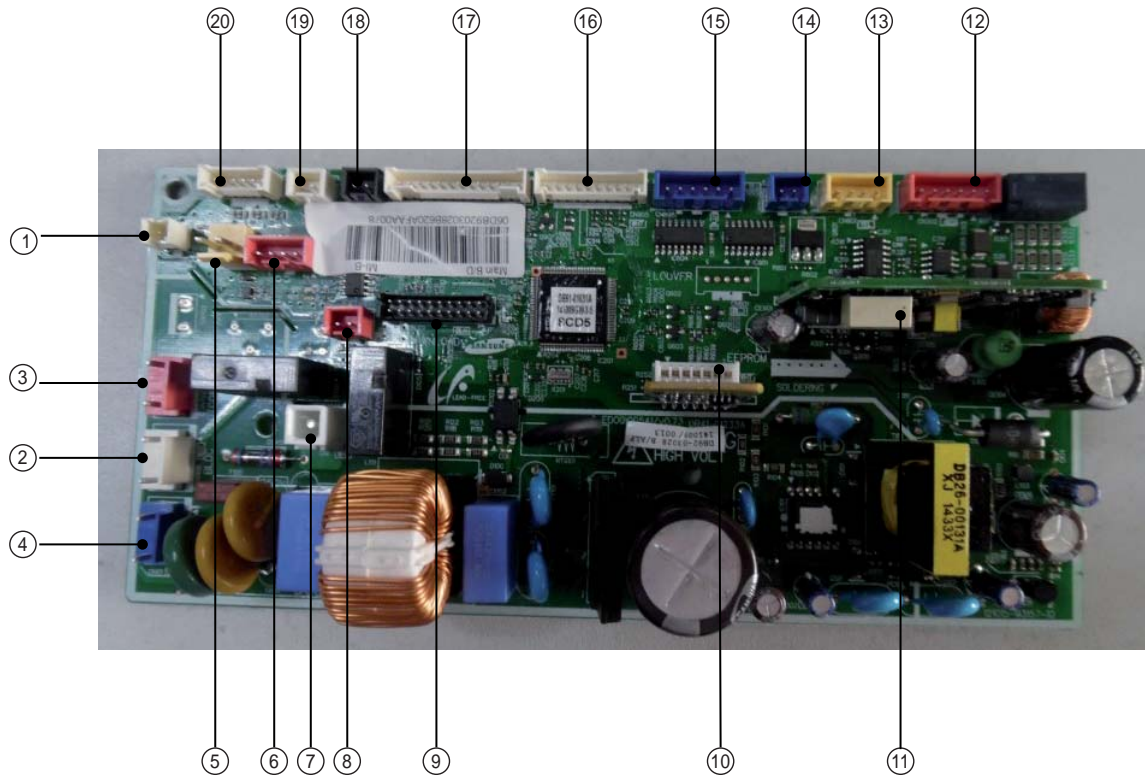

No	part code	location No.	Function	Description
1	3711-003942	CN140	Fuse Check	SMW200-02P WHT
2	3711-000203	CN906	BLDC POWER	YW396-03AV WHT
3	3711-003407	CN702	Comp Signal	YW396-03AV RED
4	3711-003404	CN101	MAIN POWER	YW396-03AV BLU
5	3711-000179	CN701	DRAIN	YW396-02V YEL
6	3711-000939	CN81	COMP ERROR	SMW250-04 RED
7	3711-000744	CN1	EARTH	YDW236-01WHT
8	3711-000796	CN83	EXT-T	SMW250-02 RED
9	3711-002001	CN301	DOWNLOAD	YDW200-20
10	3711-007817	CN201	EPPROM	B7P-MQ WHT
11	3711-004773	CN311	2 WIRE	BMW200-12 WHT
12	3711-001037	CN302	COMM	SMW250-06 RED
13	3711-000941	CN801	SPI	SMW250-04 YEL
14	3711-000795	CN804	VEN	SMW250-02 BLU
15	3711-001036	CN808	EEV	SMW250-06 BLU
16	3711-004182	CN905	FAN MOTOR COMM	SMW200-10P WHT
17	3711-003895	CN501	DISPLAY	SMW200-13P WHT
18	3711-000794	CN411	FLOAT-SW	SMW250-02 BLK
19	3711-000015	CN412	ROOM SENSOR	SMW250-02 WHT
20	3711-004236	CN413	EVA DIS/OUT SENSOR	SMW200-06P WHT

GD-S (Big Duct) (cont.)
- EMI PBA

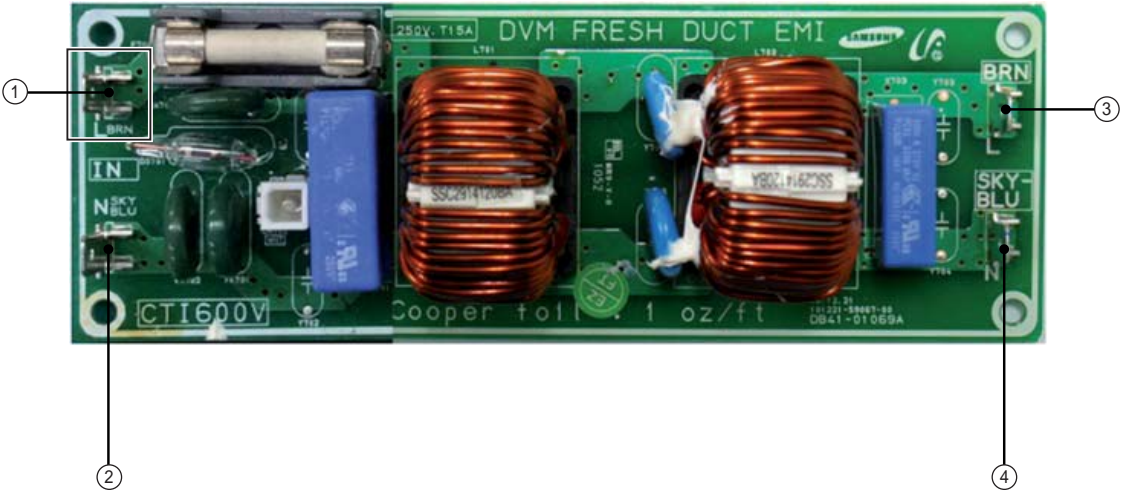

No	part code	location No.	Function	Description
1	3712-001139	L	IN-L	TAB,MALE,6.35x0.8mm
2	3712-001139	N	IN-N	TAB,MALE,6.35x0.8mm
3	3712-001139	L	OUT-L	TAB,MALE,6.35x0.8mm
4	3712-001139	N	OUT-N	TAB,MALE,6.35x0.8mm

GD-S (Big Duct) (cont.)
- BLDC PBA

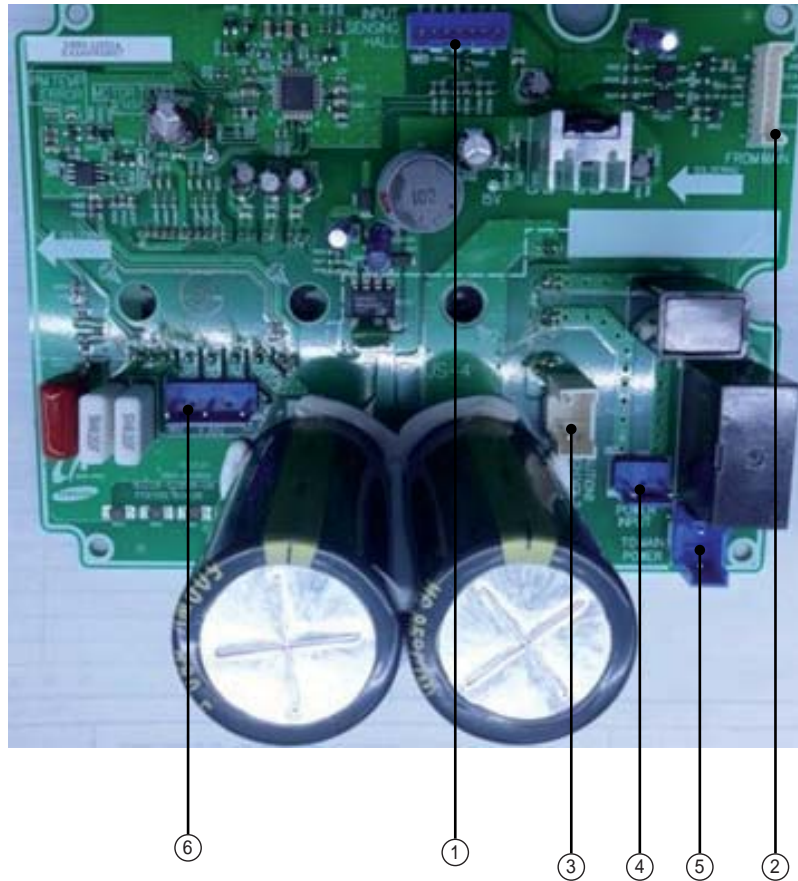

No	part code	location No.	Description
1	3711-001080	CN12	Motor signal
2	3711-004712	CN11	Main to BLDC signal
3	3711-005852	CN15	Reactor connect
4	3711-003404	CN10	BLDC PBA power
5	3711-006048	CN14	Main PBA power
6	3711-000260	CN13	Motor power

6. Wiring Diagram

6-1 Indoor

6-1-1 Global 4way(Global Mini-4way) cassette type, Slim 1way cassette (large)

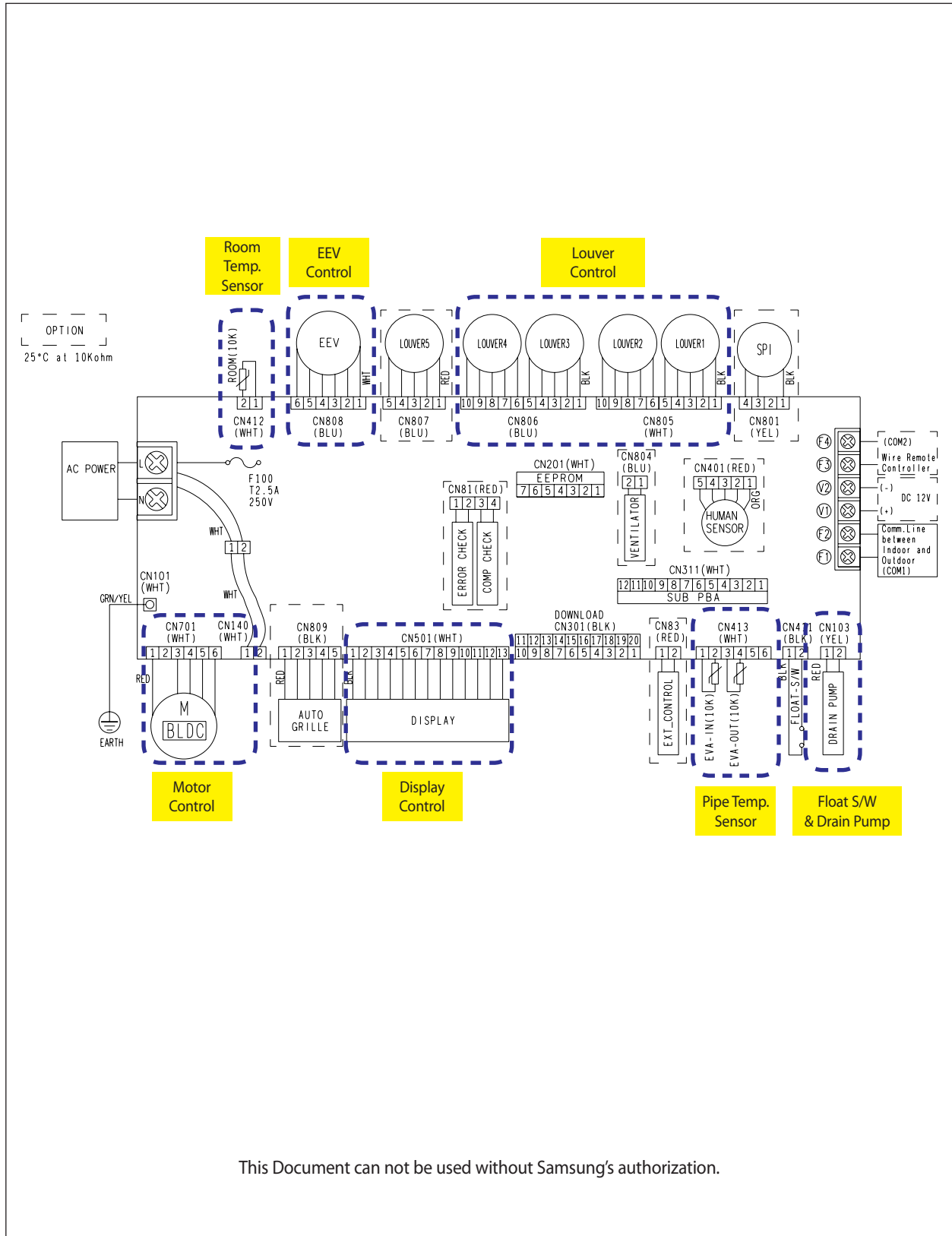

6-1-2 Slim 1 way cassette type (medium)

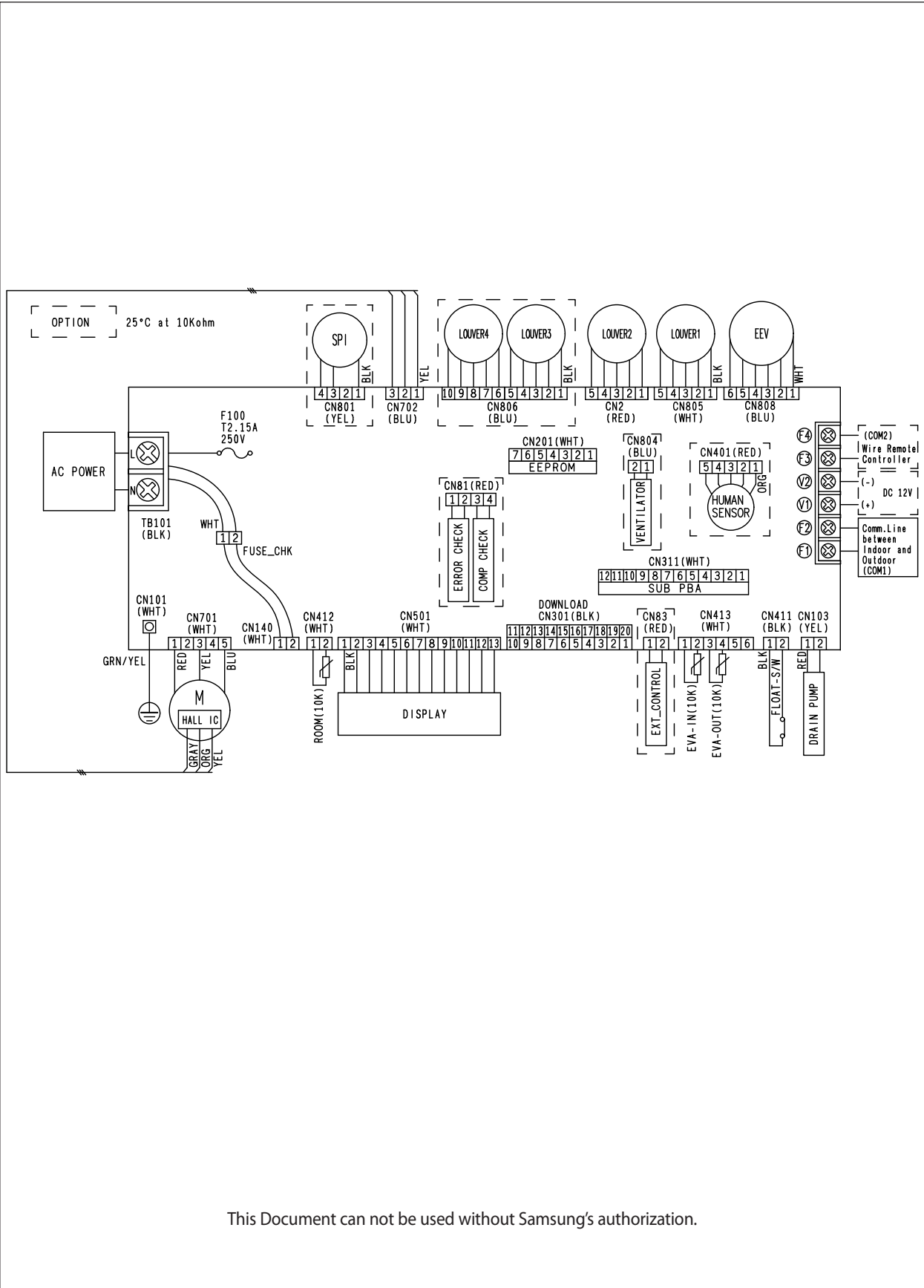

This Document can not be used without Samsung's authorization.

6-1-3 360 cassette

■ AM045/056/071/090/112/128/140KN4DEH*

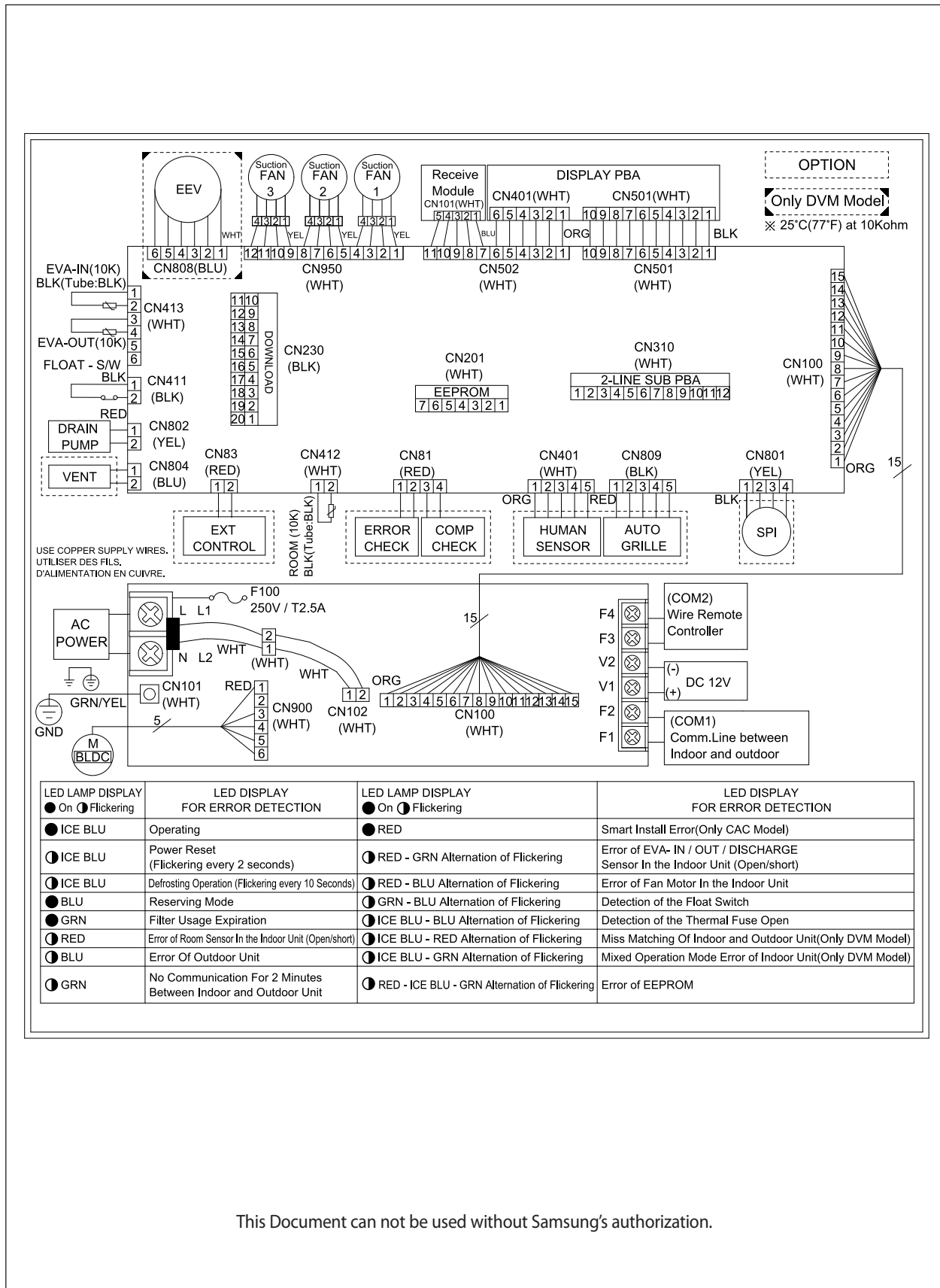

This Document can not be used without Samsung's authorization.

6-1-4 BIG Duct

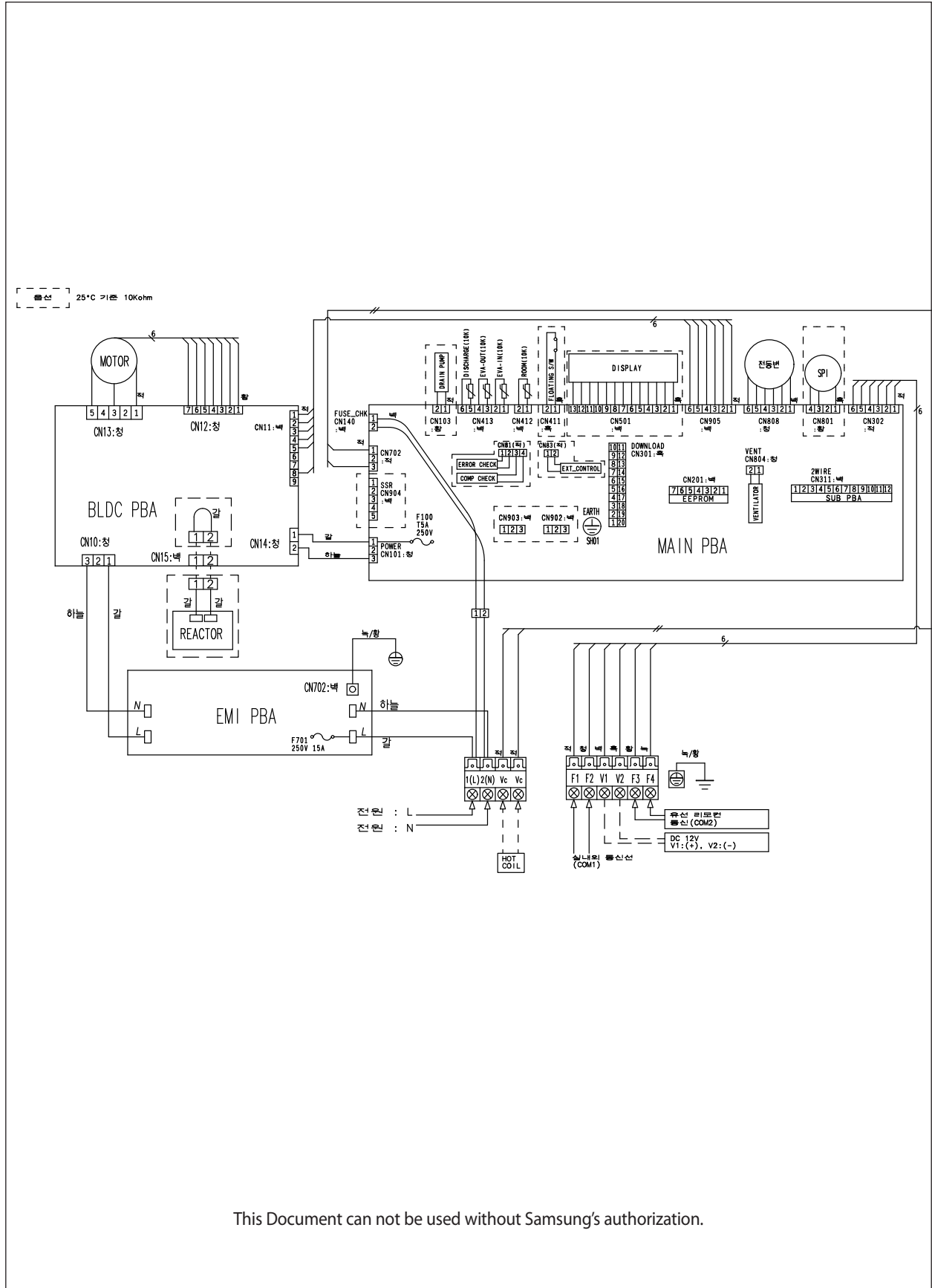

6-1-5 Ceiling

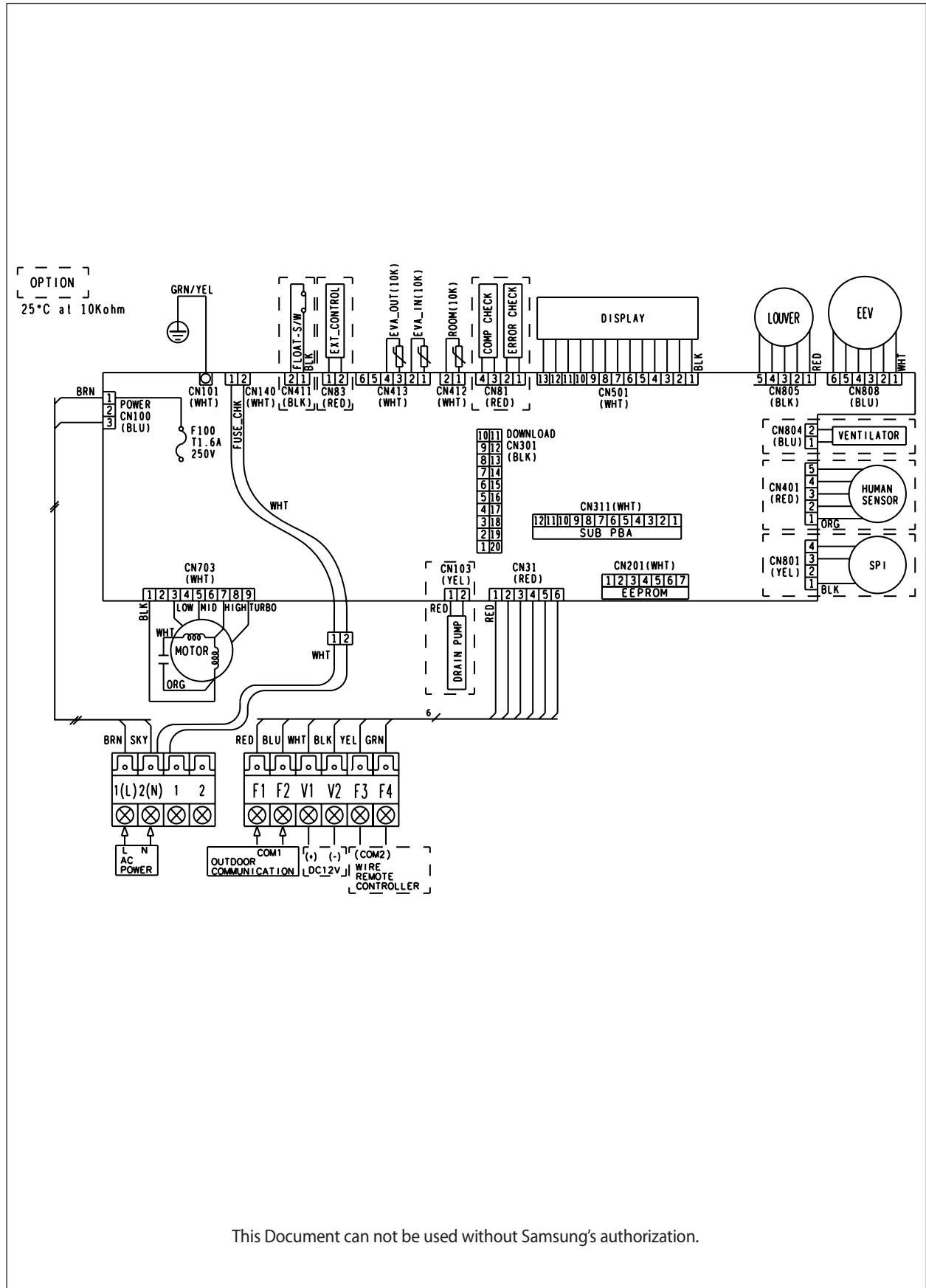

This Document can not be used without Samsung's authorization.

6-1-6 Console

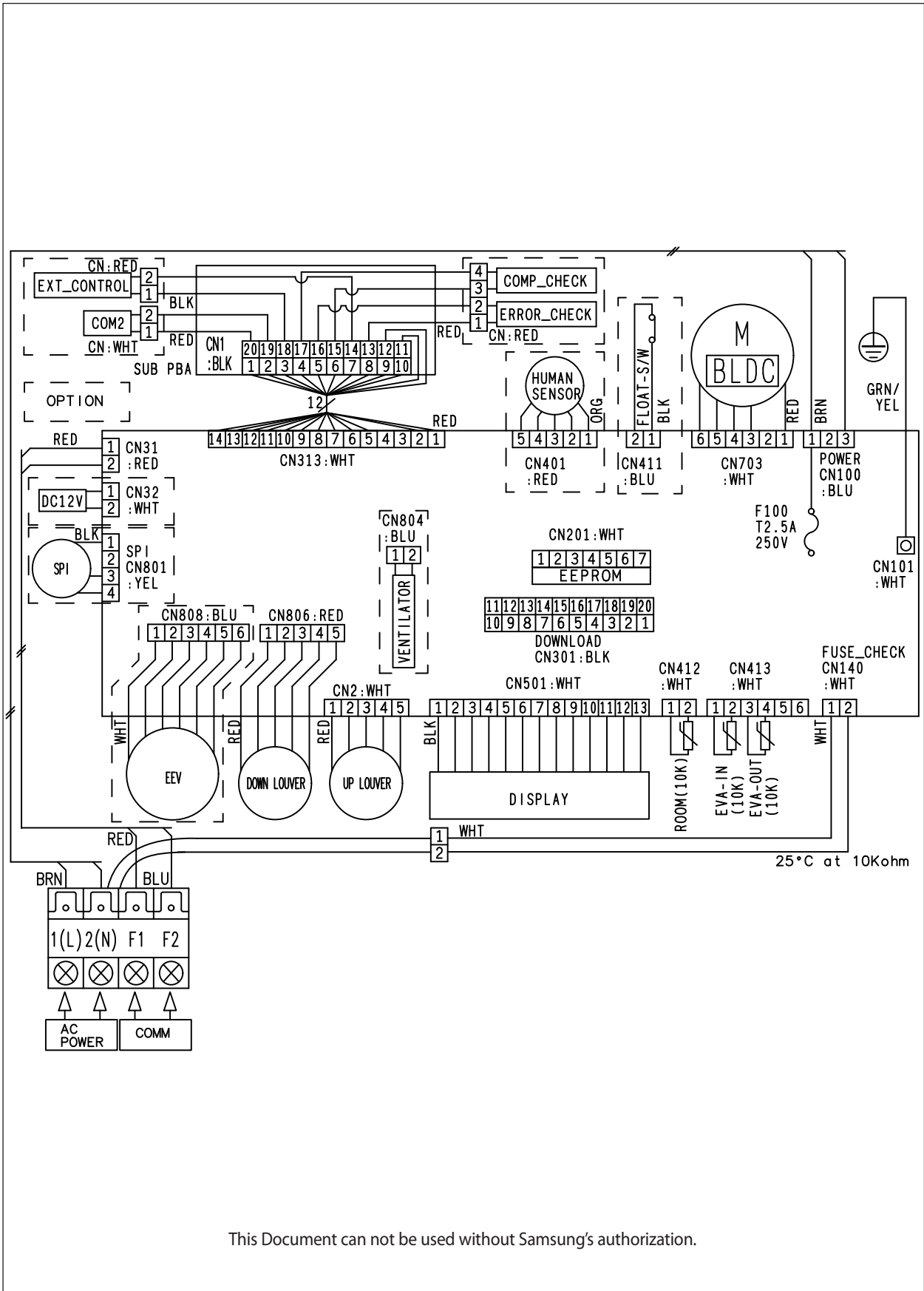

This Document can not be used without Samsung's authorization.

6-1-7 Wall Mounted type(Neo Forte without EEV)

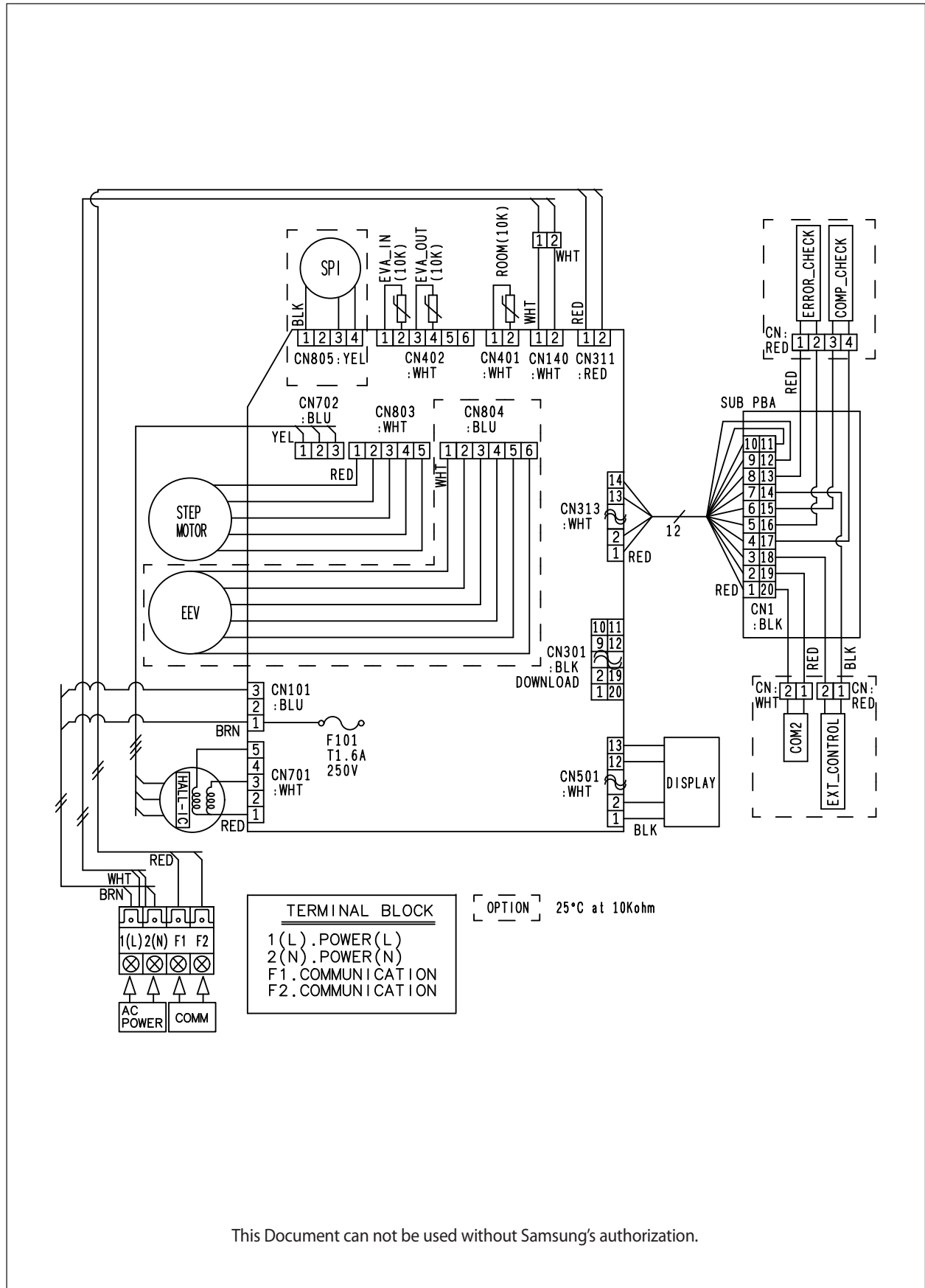

6-1-8 Wall Mounted type(A3050)

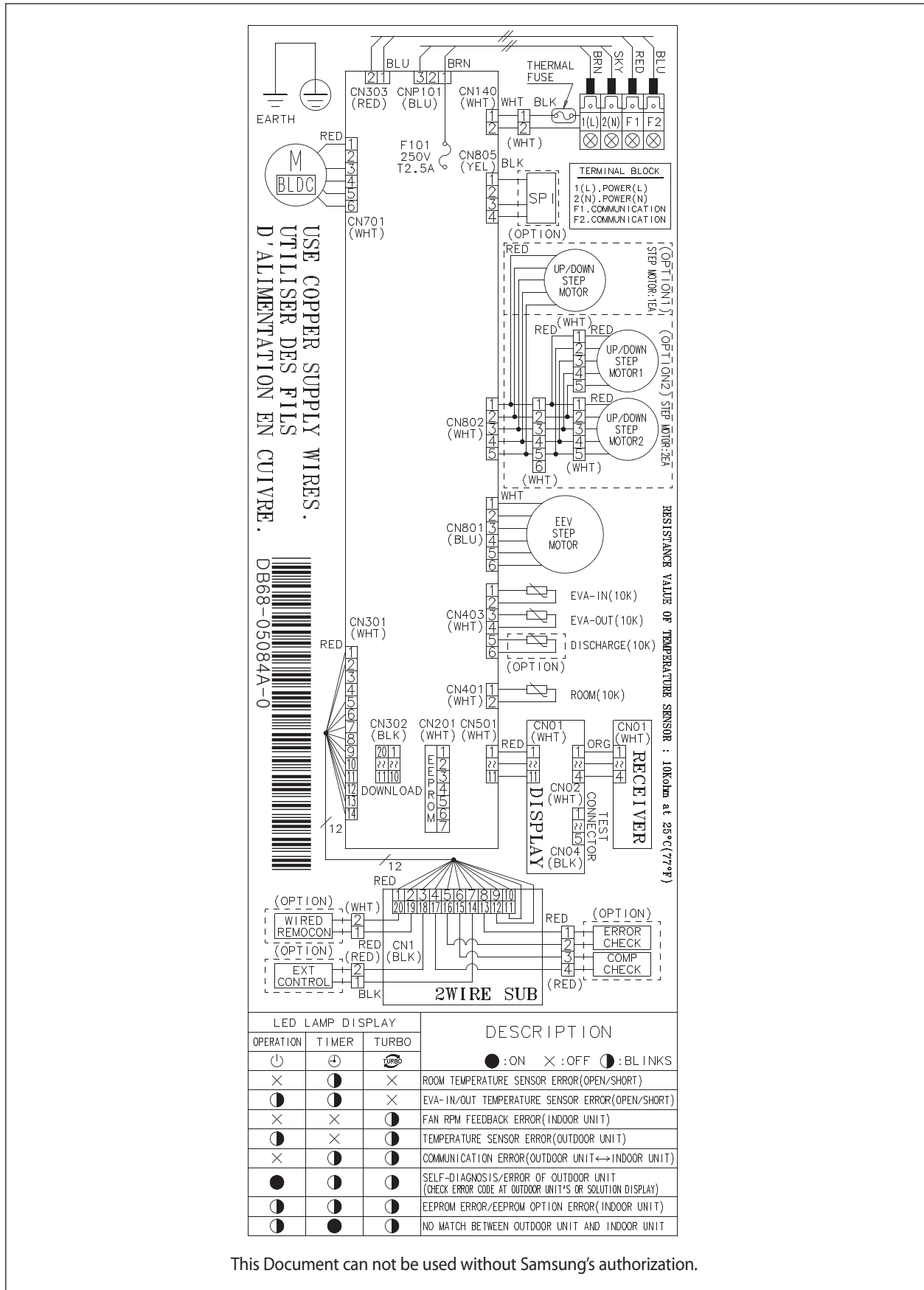

This Document can not be used without Samsung's authorization.

6-1-9 2way cassette type

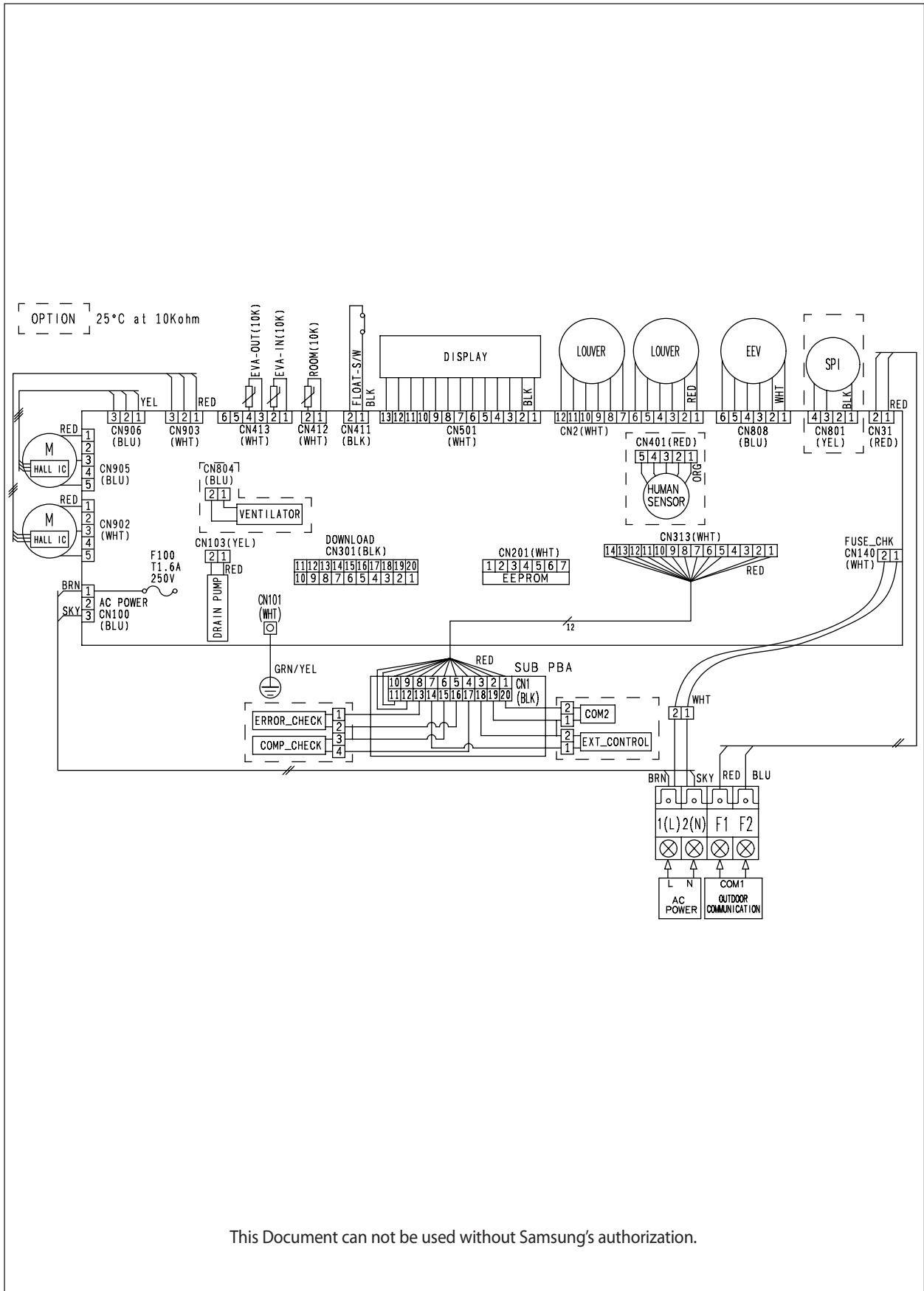

This Document can not be used without Samsung's authorization.

6-1-10 DUCT type (Slim III)

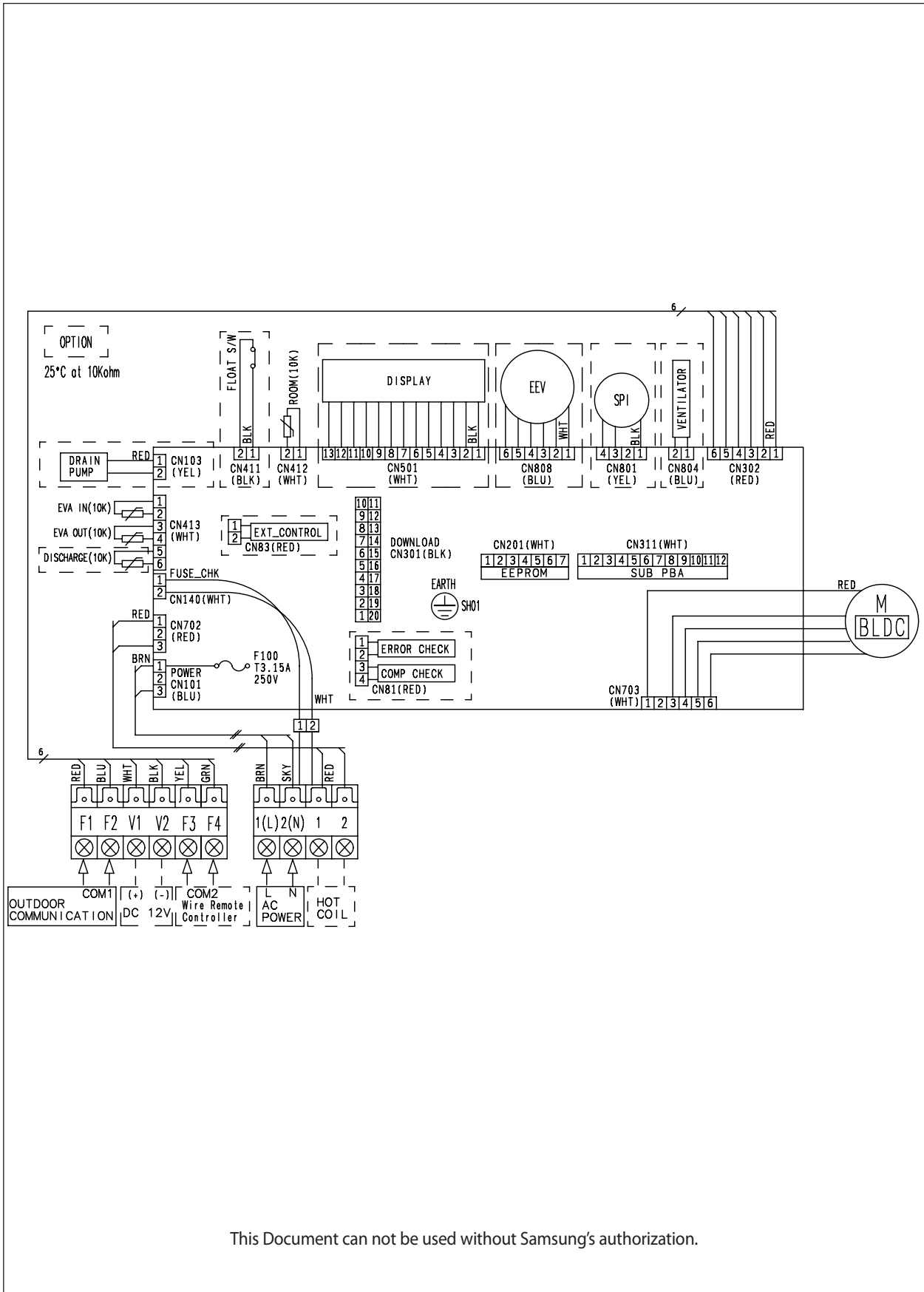

This Document can not be used without Samsung's authorization.

6-1-11 DUCT type (Slim I, II, MSP)

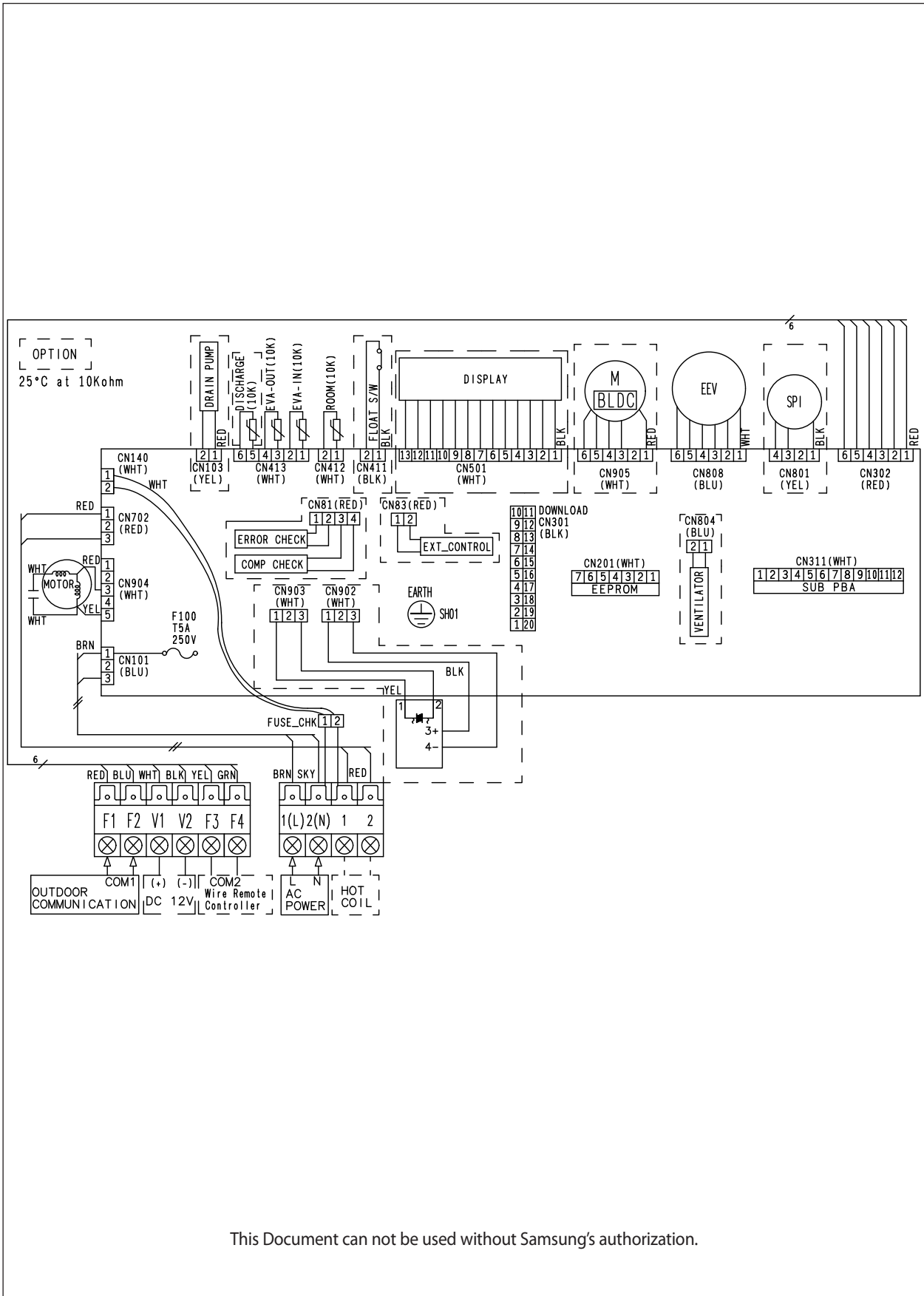

This Document can not be used without Samsung's authorization.

6-1-12 Duct type (HSP)

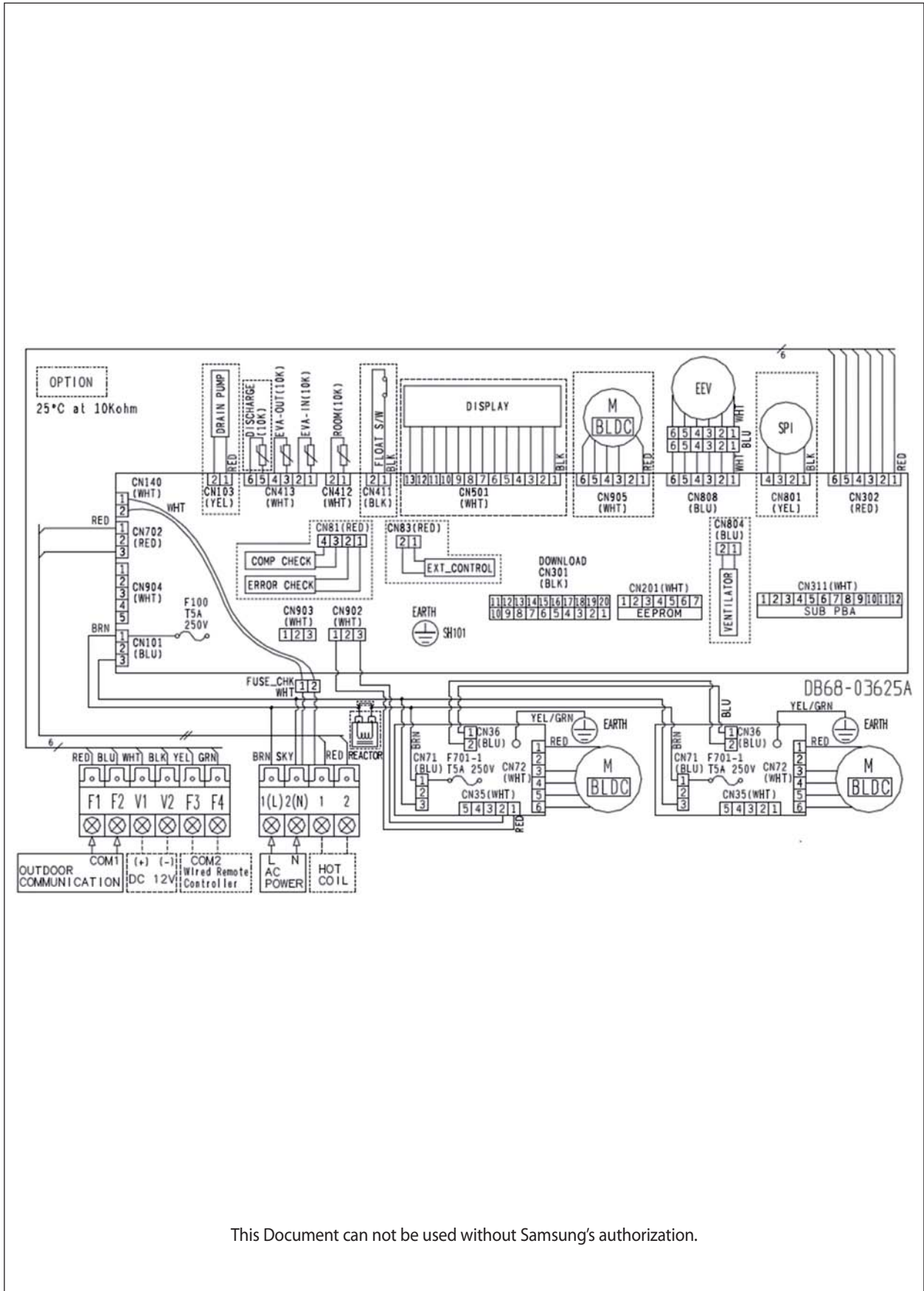

This Document can not be used without Samsung's authorization.

6-1-13 Floor Stand Type

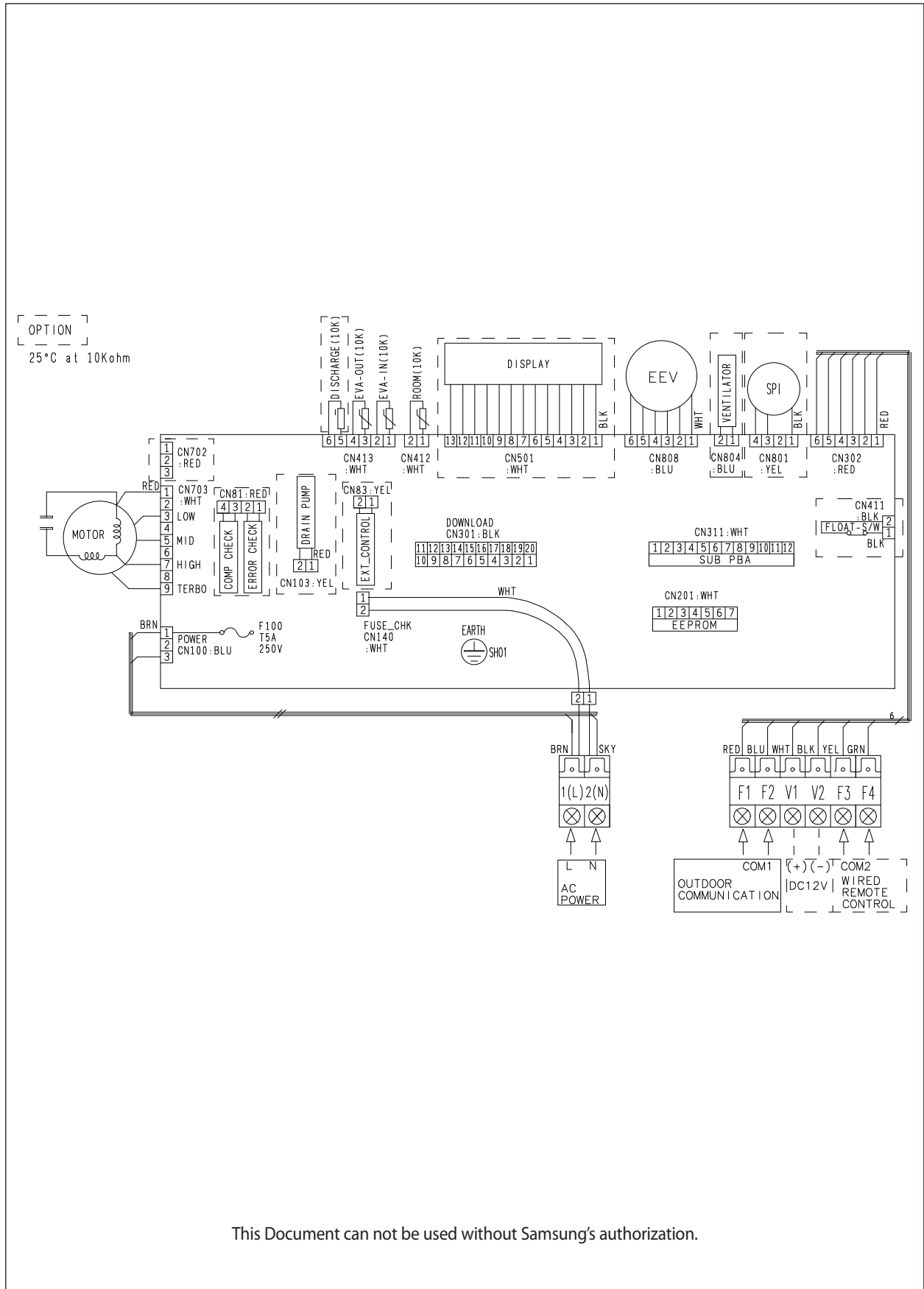

This Document can not be used without Samsung's authorization.

6-1-14 ERV Plus

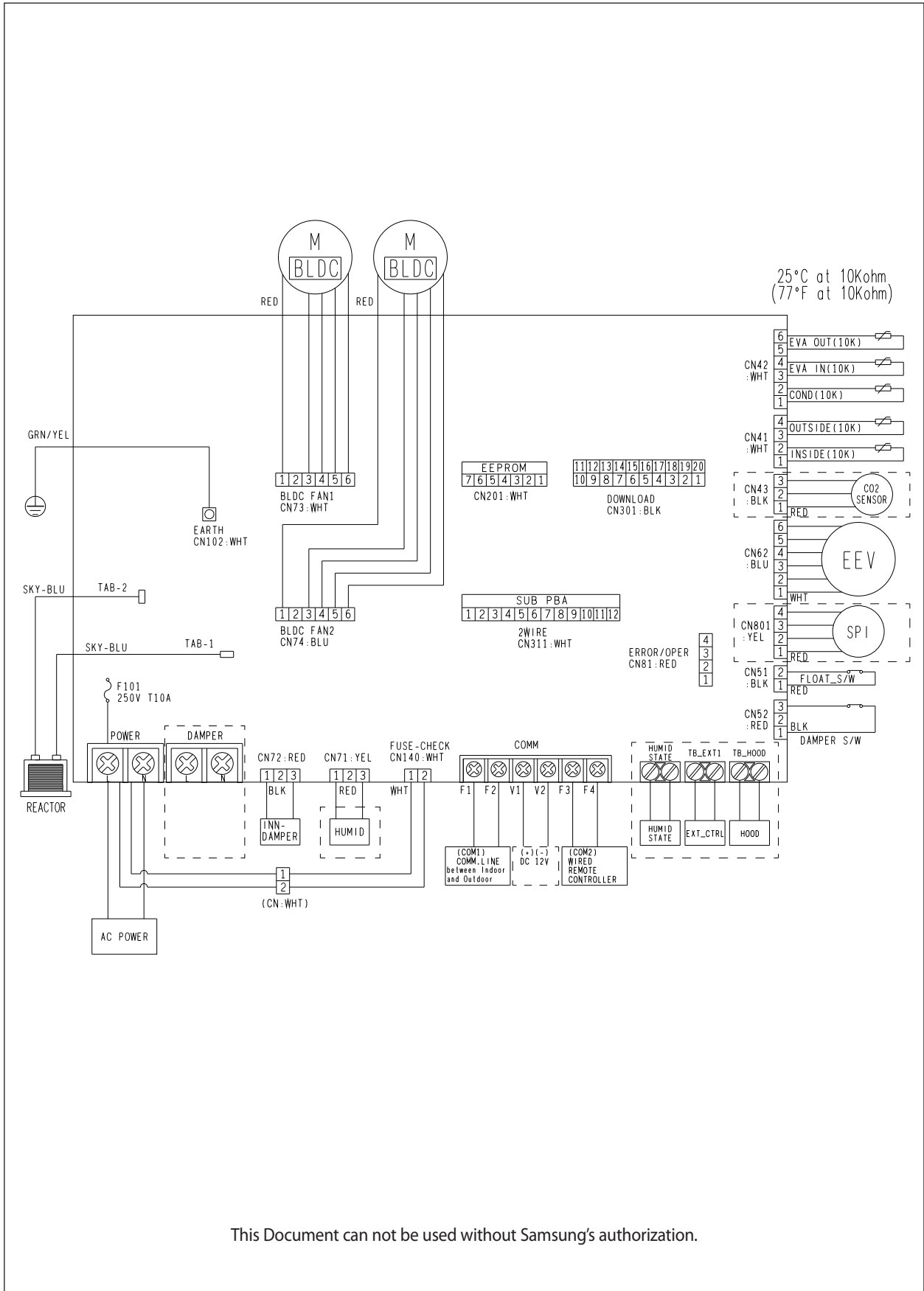

This Document can not be used without Samsung's authorization.

6-1-15 GD-S (Big Duct)

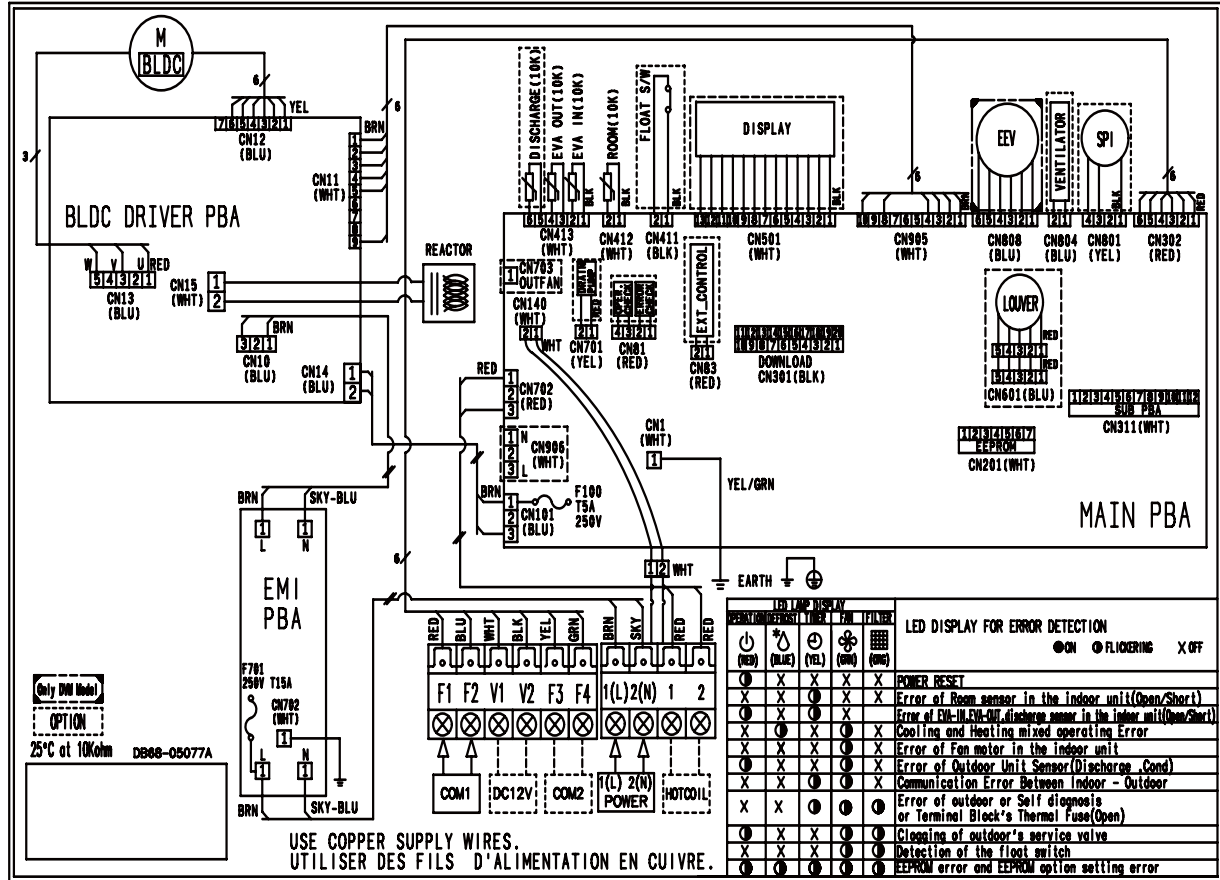

This Document can not be used without Samsung's authorization.

7. Reference Sheet

7-1 Index for Model Name

7-1-1 Indoor Unit

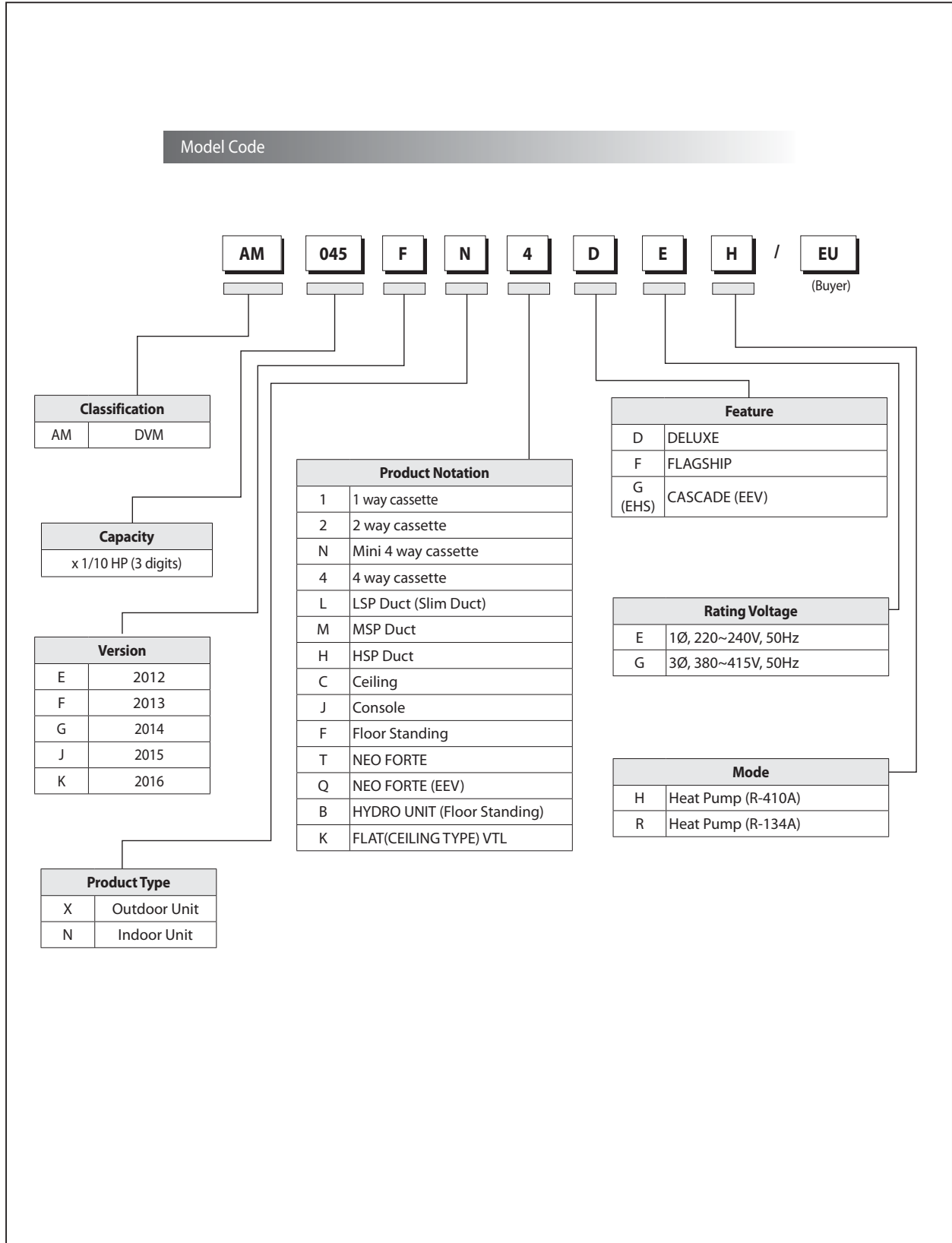

Index for Model Name(cont.)

7-1-2 Panel

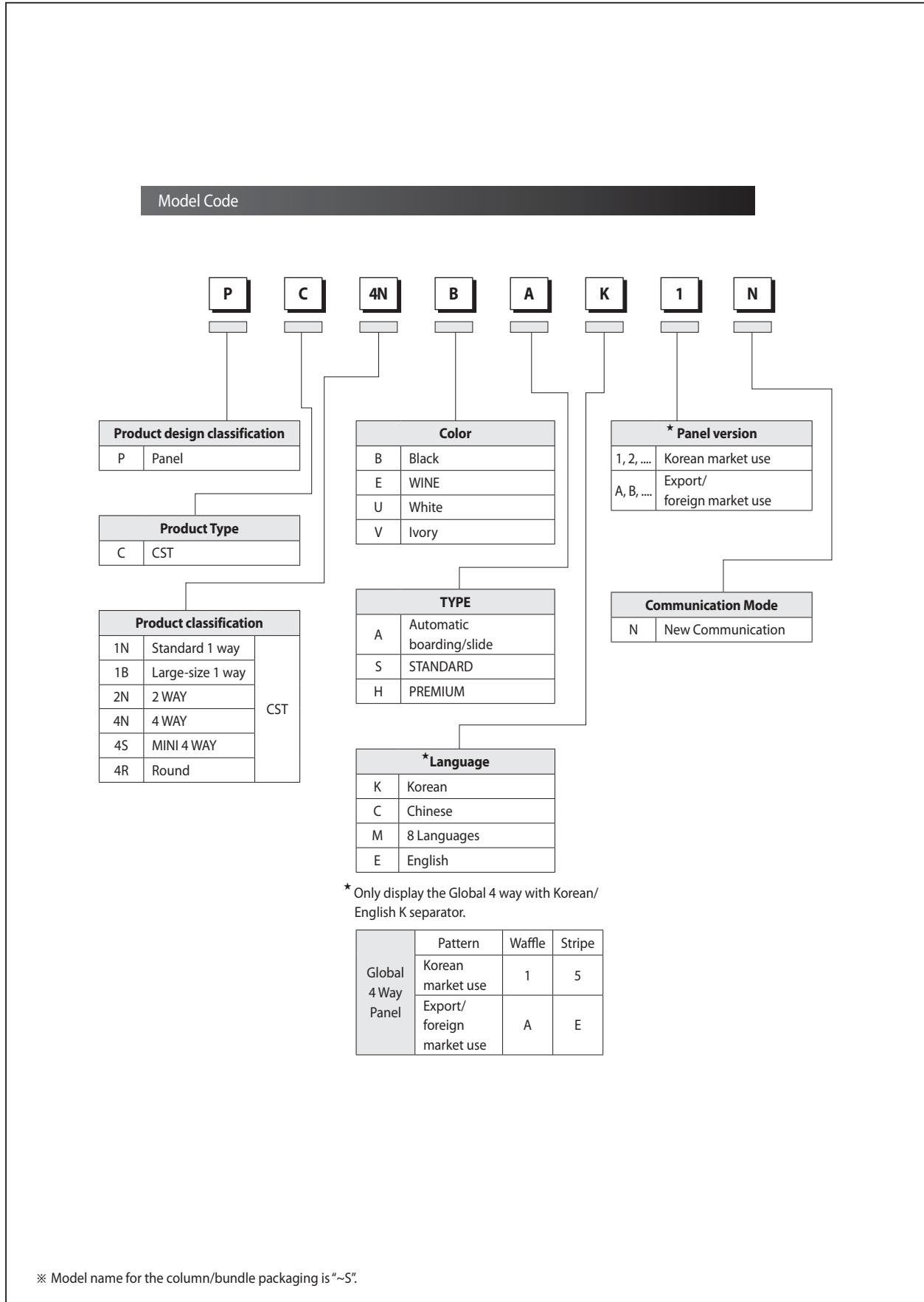

7-2 Pump-down Method

7-2-1 Precautions for Pump-down

1. If the pressure is kept low for a long time to completely replenish the refrigerant of the pipe during the pump-down, then the compressor may be damaged. Therefore, close the valve immediately if the pressure goes below $2\text{kg}/\text{cm}^2\text{g}$.
2. If the length of the pipe is too long or the outside temperature is too high, then it may not be able to pump down all of the refrigerant. In this case, use an empty refrigerant container which can be used for recharge to place some of the system refrigerant inside the container. The pump down can be easily carried out if only the remaining refrigerant is pumped down.



- Please use a rechargeable container for exclusive use when putting the refrigerant in the container. Accidents such as explosions can happen and result in damage if normal refrigerant containers are used after illegal modification.

7-2-2 For Single Installation of Outdoor Unit (Only One Outdoor Unit Installed)

1. Close the liquid pipe SVC valve.
2. Press the K2 Button on the PCB of the main outdoor unit. ("K7" mark displayed on the outdoor unit PCB LED.)
3. Observe for low pressure by using the K4 button's view mode once the compressor starts operating.
(If the first number of the LED is "4," then the following three digits represent the low pressure, expressed up to the first decimal point.)
Example: 41 22 → 4 means the value of the low pressure, and 122 means that the low pressure is $12.2\text{kg}/\text{cm}^2\text{g}$.
4. If the low pressure goes below around $2\text{kg}/\text{cm}^2\text{g}$, then immediately close the SVC valve for the gas and finish the pump-down operation.
(Finish the pump-down operation, press K2 button two more times, or reset the operation by pressing the K3 button once more.)

7-2-3 When Two or More Outdoor Units are Installed

1. Close the gas valves of each sub unit.
2. Press the K2 button of the outdoor unit PCB three times. At this time, K7 will be displayed on the PCB LED. After pressing the button, wait for about 20~30 minutes once the main unit compressor starts operating.
3. Close the liquid pipe valves of each sub unit.
4. Close the liquid pipe valves of the main unit, and observe for low pressure as in the case of a single outdoor unit.
5. Close the gas valve of the main unit if the pressure drops down, and then finish the pump-down operation mode.

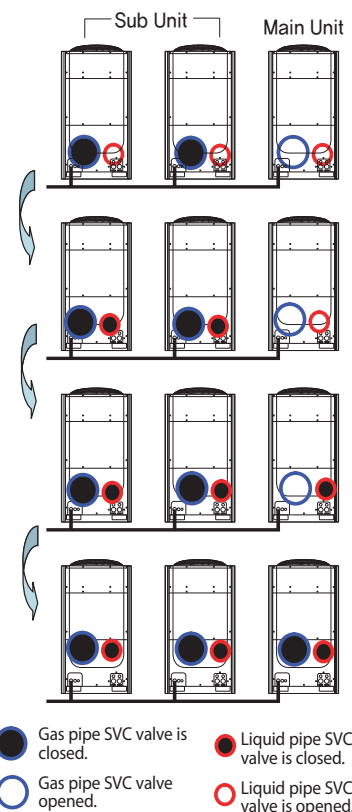

7-3 How to Put Refrigerant in Refrigerant Container

7-3-1 How to put refrigerant in container before pump-down

1. Prepare a rechargeable exclusive refrigerant container, a scale, and a Manifold gauge.
2. Check the amount of refrigerant remaining in the overall system at the time.
3. Connect the refrigerant container to the outdoor unit as shown in the following figure, and operate only about 50% of the total indoor units in air conditioning mode.
4. Check the high pressure from the Manifold gauge 10 minutes after the air conditioning begins operation.
Reduce the number of indoor units in operation if the high pressure goes above $30\text{kg}/\text{cm}^2\text{g}$. to lower the high pressure below $30\text{kg}/\text{cm}^2\text{g}$.
5. Check that the high pressure goes below $30\text{kg}/\text{cm}^2\text{g}$, and open the Manifold gauge connected to the liquid pipe, as well as the refrigerant container valve, so that the refrigerant flows from the liquid pipe to the refrigerant container.
6. Check the changes in the weight of the container using the scale. Once the desired amount of refrigerant is filled up inside the container, close the valves, and then remove the Manifold gauge.
7. The amount of refrigerant that can be contained inside the container is about 50% of the amount of refrigerant inside the overall system.
8. Please take extra caution by precisely determining the amount of the refrigerant that can be put in each container so that too much refrigerant is not contained in the container.
The weight must be measured by using a scale to avoid putting more refrigerant than the amount originally contained in the container.

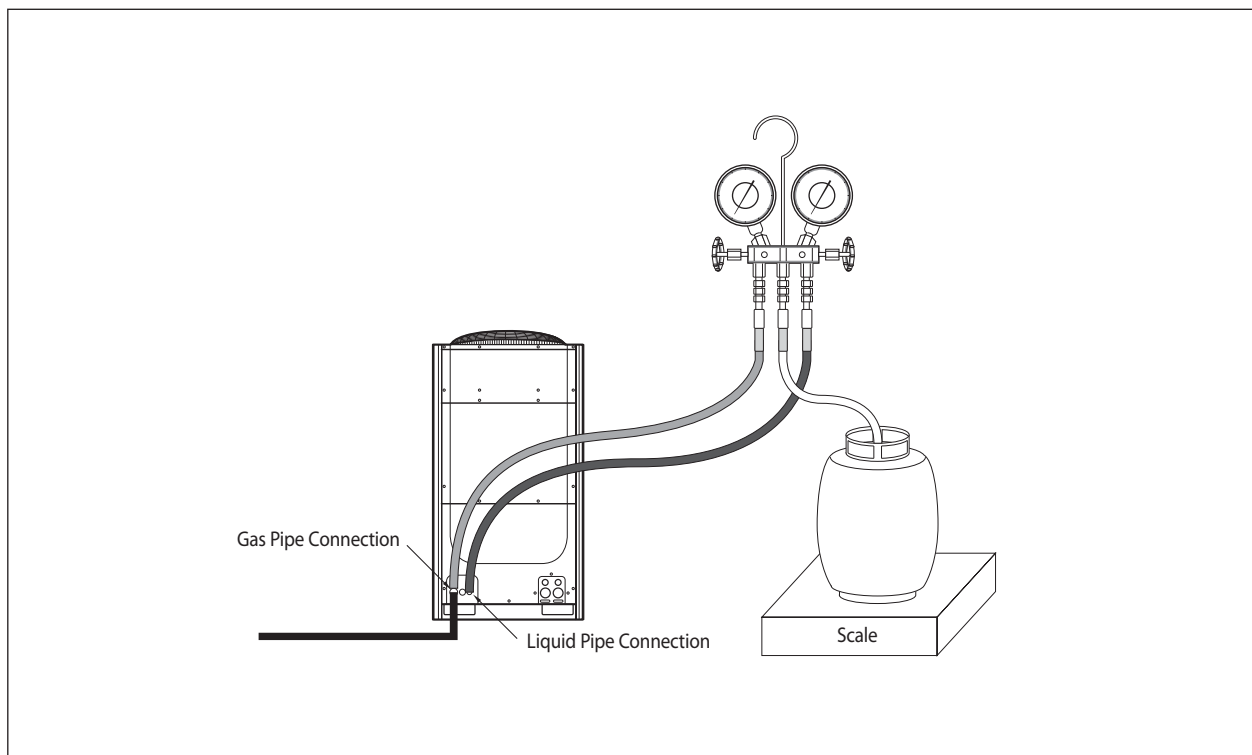



GSPN (GLOBAL SERVICE PARTNER NETWORK)

Area	Web Site
Europe, CIS, Mideast & Africa	gspn1.samsungcsportal.com
Asia	gspn2.samsungcsportal.com
North & Latin America	gspn3.samsungcsportal.com
China	china.samsungportal.com

This Service Manual is a property of Samsung Electronics Co., Ltd.
Any unauthorized use of Manual can be punished under applicable
International and/or domestic law.

© Samsung Electronics Co., Ltd. August. 2016.
Printed in Korea.
Code No. AC-00129E_3