

FDT series (RCN-T-5AW-E2)

Notes:

Following function of FDT indoor unit series are not able to be set with this wireless remote control (RCN-E2).

1. Flap control system
2. 4-fan speed setting (P-Hi/Hi/Me/Lo) → 3-fan speed setting (Hi/Me/Lo)

PJF012D035













Safety precautions

- Please read this manual carefully before starting installation work to install the unit properly. Every one of the followings is important information to be observed strictly.
 - ⚠ **WARNING** Failure to follow these instructions properly may result in serious consequences such as death, severe injury, etc.
 - ⚠ **CAUTION** Failure to follow these instructions properly may cause injury or property damage. It could have serious consequences depending on the circumstances.
- The following pictograms are used in the text.

	Never do.		Always follow the instructions given.
-----------------------------------------------------------------------------------	-----------	-----------------------------------------------------------------------------------	---------------------------------------

- Keep this manual at a safe place where you can consult with whenever necessary. Show this manual to installers when moving or repairing the unit. When the ownership of the unit is transferred, this manual should be given to a new owner.

⚠ WARNING

-  • **Consult your dealer or a professional contractor to install the unit.**
Improper installation made on your own may cause electric shocks, fire or dropping of the unit.
-  • **Installation work should be performed properly according to this installation manual.**
Improper installation work may result in electric shocks, fire or break-down.
-  • **Be sure to use accessories and specified parts for installation work.**
Use of unspecified parts may result in drop, fire or electric shocks.
-  • **Install the unit properly to a place with sufficient strength to hold the weight.**
If the place is not strong enough, the unit may drop and cause injury.
-  • **Be sure to have the electrical wiring work done by qualified electrical installer, and use exclusive circuit.**
Power source with insufficient and improper work can cause electric shock and fire.
-  • **Shut OFF the main power source before starting electrical work.**
Otherwise, it could result in electric shocks, break-down or malfunction.
-  • **Do not modify the unit.**
It could cause electric shocks, fire, or break-down.
-  • **Be sure to turn OFF the power circuit breaker before repairing/inspecting the unit.**
Repairing/inspecting the unit with the power circuit breaker turned ON could cause electric shocks or injury.
-  • **Do not install the unit in appropriate environment or where inflammable gas could generate, flow in, accumulate or leak.**
If the unit is used at places where air contains dense oil mist, steam, organic solvent vapor, corrosive gas (ammonium, sulfuric compound, acid, etc) or where acidic or alkaline solution, special spray, etc. are used, it could cause electric shocks, break-down, smoke or fire as a result of significant deterioration of its performance or corrosion.
-  • **Do not install the unit where water vapor is generated excessively or condensation occurs.**
It could cause electric shocks, fire, or break-down.
-  • **Do not use the unit in a place where it gets wet, such as laundry room.**
It could cause electric shocks, fire, or break-down.
-  • **Do not operate the unit with wet hands.**
It could cause electric shocks.

⚠ WARNING



- **Do not wash the unit with water.**
It could cause electric shocks, fire, or break-down.



- **Use the specified cables for wiring, and connect them securely with care to protect electronic parts from external forces.**
Improper connections or fixing could cause heat generation, fire, etc.



- **When installing the unit at a hospital, telecommunication facility, etc., take measures to suppress electric noises.**
It could cause malfunction or break-down due to hazardous effects on the inverter, private power generator, high frequency medical equipment, radio communication equipment, etc.
The influences transmitted from the remote control to medical or communication equipment could disrupt medical activities, video broadcasting or cause noise interference.



- **Do not leave the remote control with its PCB case removed.**
If dew, water, insect, etc. enters through the hole, it could cause electric shocks, fire or break-down.

⚠ CAUTION



- Do not install the wireless kit at the following places in order to avoid malfunction.
It could cause break-down or deformation of remote control.

(1) Places exposed to direct sunlight	(8) Places where the receiver is influenced by the fluorescent lamp (especially inverter type) or sunlight
(2) Places near heat devices	(9) Places where the receiver is affected by infrared rays of any other communication devices
(3) High humidity places	(10) Places where some object may obstruct the communication with the remote control
(4) Hot surface or cold surface enough to generate condensation	
(5) Places exposed to oil mist or steam directly	
(6) Uneven surface	
(7) Places affected by the direct air flow of the AC unit	

① Accessories

Please make sure that you have all of the following accessories.

① Receiver		1	→	① Wireless remote control (RCN-E2)		1
② Parts set (A)		1		② Remote control holder		1
③ Installation manual		1		③ Screw for holder		2
				④ AAA dry cell battery (LR03)		2
				⑤ User's manual		1

② Preparation before installation

Setting on site

PCB on the receiver has the following switches to set the function.
Default setting is shown with mark.

SW1	Prevents interference during plural setting	<input checked="" type="checkbox"/> ON : Normal	OFF : Customized
SW2	Receiver master/slave setting	<input checked="" type="checkbox"/> ON : Master	OFF : Slave
SW3	Buzzer	<input checked="" type="checkbox"/> ON : Valid	OFF : Invalid
SW4	Auto restart	ON : Valid	<input checked="" type="checkbox"/> OFF : Invalid

② Preparation before installation (continued)

To change setting

1. Remove the cover by unscrewing two screws from the back of receiver.
2. Change the setting by the switch on PCB.

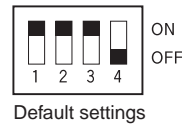
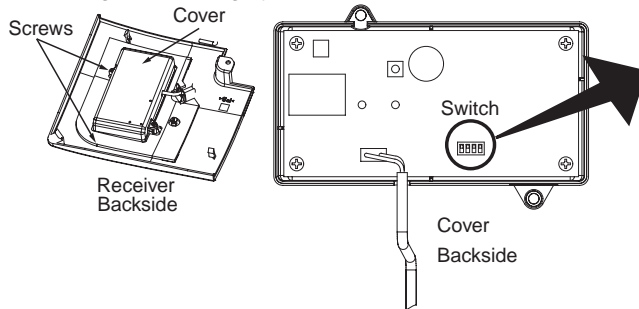

Master/Slave setting when using plural remote controls

Up to two receiver or wired remote control can be installed in one indoor unit group. When two receiver or wired remote control are used, it is necessary to change SW on the PCB to set it as slave.

3. When SW1 is turned to OFF position, change the wireless remote control setting. For the method of changing the setting, refer to **Setting to avoid mixed communication** of

④ Wireless remote control

*The receivable area of the signal refer to **⑤ Receiver**.

③ How to install the receiver

The receiver can be installed by replacing with a corner panel on the applicable decorative panel.

Preparation before installation

- ① Attach the decorative panel onto the air-conditioner according to the installation manual for the panel.
- ② Remove the air return grille.
- ③ Remove a corner panel located on the refrigerant pipes side.
- ④ Remove three screws and detach the cover (indicated as shadowed area) from the control box of the air-conditioner.

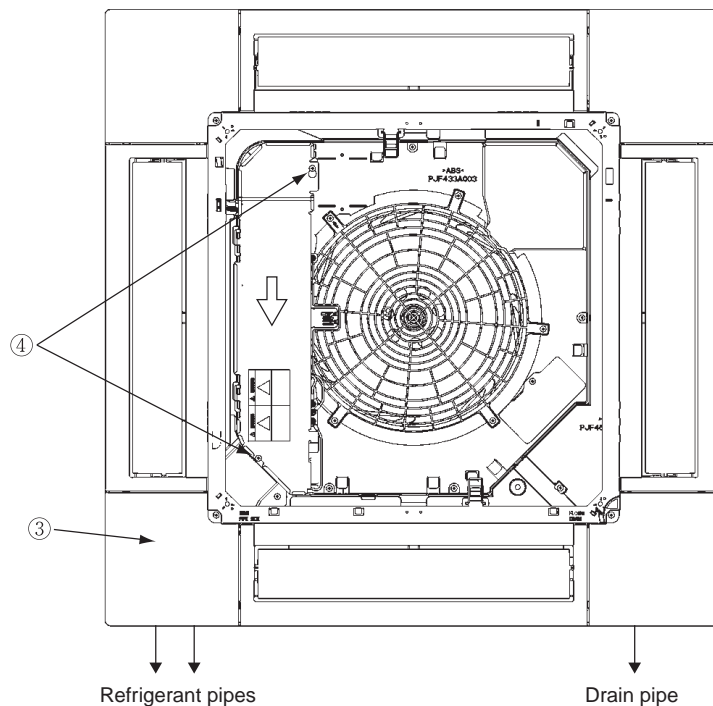

③ How to install the receiver(continued)

Installation of the receiver

- ① Loosen the bolts which fix the panel and make a gap between the panel and the indoor unit
- ② Put the wiring of the receiver through the opening.
- ③ Put the wiring on the notch on the control box so as not to be pinched by the control box and lid as shown below.
- ④ Connect the wiring to the terminal block provided in the control box. (No polarity)
- ⑤ Attach the receiver to the panel according to the panel installation manual.
- ⑥ Fix the wiring with the clamp so that the wiring do not contact the edge of control box's metal sheet.
- ⑦ Reattach the control box lid with 3 screws removed.

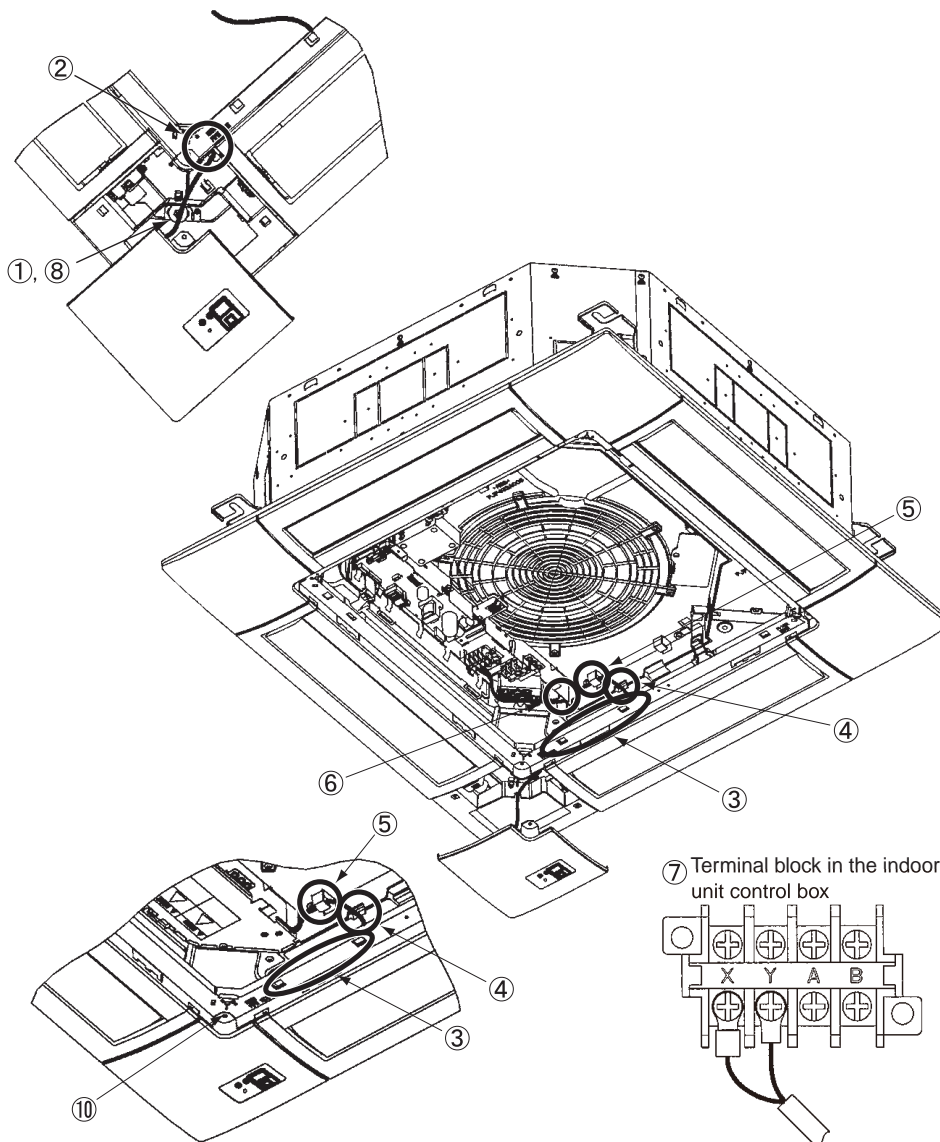

4 Wireless remote control

Installation tips for the remote control holder

Fix the remote control holder using the screws supplied with this product.

* Precautions for installing the holder

- Adjust the position so that it is upright.
- Ensure that the screw heads are not protruding.
- Do not attach the holder on plaster wall.

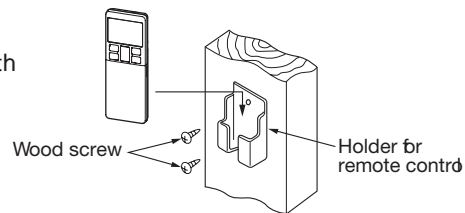

How to insert batteries

1. Detach the back lid.
2. Insert the batteries. (two AAA batteries)
3. Reattach the back lid.

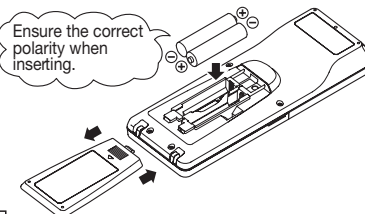

Setting to avoid mixed communication

1. Detach the back lid, and remove the batteries.
2. Cut off the switching wire in the battery compartment using nippers.
3. Insert the batteries, and attach the back lid.



Changing the remote control setting

How to change the Auto Run setting

The Auto Run mode is not available on the building air-conditioning and gas heat pump series (excluding the cooling/heating free multi system).

When using the remote control to operate those models, set the remote control to disable the Auto Run mode.

To disable the Auto Run mode, press the **ACL** switch while holding down the **MODE** button, or insert batteries while holding down the **MODE** button.

* Note: Once the batteries are removed, the setting is reset to the factory default. When the batteries are removed, repeat the steps described above.

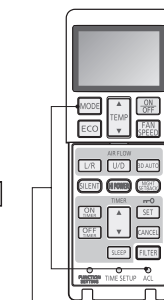

Indoor function settings

1. How to set indoor functions
 - ① Press the ON/OFF button to stop the unit.
 - ② Press the desired one of the buttons shown item 2. while holding down the FUNCTION SETTING switch.
 - ③ Use the selection buttons, ▲ and ▼, to change the setting.
 - ④ Press the SET button.The buzzer on the remote control signal receiver beeps twice, and the LED lamp flashes four times at two-second intervals.

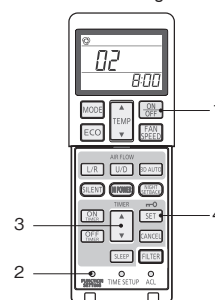

4 Wireless remote control (continued)

2. Setting details

The following functions can be set.

Button	Number indicator	Function setting
FAN SPEED	00	Fan speed setting : Standard
	01	Fan speed setting : Setting 1 *
	02	Fan speed setting : Setting 2 *
MODE	00	Room heating temperature adjustment : Disable
	01	Room heating temperature adjustment : +1°C
	02	Room heating temperature adjustment : +2°C
	03	Room heating temperature adjustment : +3°C
FILTER	00	Filter sign display : OFF
	01	Filter sign display : 180 hours
	02	Filter sign display : 600 hours
	03	Filter sign display : 1000 hours
	04	Filter sign display : Operation stop after 1000 hours have elapsed
U/P	00	Anti draft setting : Disable
	01	Anti draft setting : Enable
SILENT	00	Infrared sensor setting (Motion sensor setting) : Disable
	01	Infrared sensor setting (Motion sensor setting) : Enable
HI POWER	00	Infrared sensor control (Motion sensor control) : Disable
	01	Infrared sensor control (Motion sensor control) : Power control only
	02	Infrared sensor control (Motion sensor control) : Auto OFF only
	03	Infrared sensor control (Motion sensor control) : Power control and Auto OFF
ON TIMER	00	Cooling fan residual-period running : Disable
	01	Cooling fan residual-period running : 0.5 hours
	02	Cooling fan residual-period running : 2 hours
	03	Cooling fan residual-period running : 6 hours
OFF TIMER	00	Heating fan residual-period running : Disable
	01	Heating fan residual-period running : 0.5 hours
	02	Heating fan residual-period running : 2 hours
	03	Heating fan residual-period running : 6 hours
NIGHT SETBACK	00	Remote control signal receiver LED : Brightness High
	01	Remote control signal receiver LED : Brightness Low
	02	Remote control signal receiver LED : OFF

* Refer to technical data.

5 Receiver

1 Control plural indoor units with one remote control

Up to 16 indoor units can be connected.

1. Connect the XY terminal with 2 cores wire. As for the size, refer to the following note.
2. For Packaged air-conditioner series, set the indoor unit address with SW2 on the indoor unit PCB from [0] to [F] so as not to duplicate.

Restrictions on the thickness and length of wire
(Maximum total extension 600m.)

Standard	Within	0.3 mm ² × 100m
	Within	0.5 mm ² × 200m
	Within	0.75mm ² × 300m
	Within	1.25mm ² × 400m
	Within	2.0 mm ² × 600m

For the shop series

For VRF series, set the indoor unit address with SW1, SW2 and SW5-2 on the indoor unit PCB from [000] to [127] so as not to duplicate.

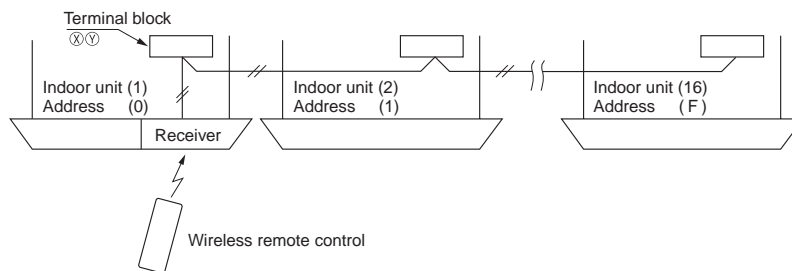

For the building air-conditioner and gas heat pump series

Set the indoor unit and outdoor unit numbers by manually specifying the addresses.

Use the rotary switches SW1 and SW2 provided on the indoor unit PCB (printed circuit board) to set the indoor unit numbers so that they are not duplicated.

Master/Slave setting when using plural remote control

Up to two receivers can be installed in one indoor unit group.

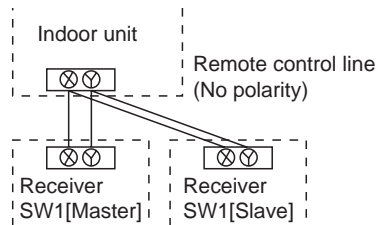

Switch	Setting	Function
SW2	ON	Master
	OFF	Slave

Wireless remote control's operable area

1. Standard reachable area of the signal
[condition] Illuminance at the receiver: 300lux
(when no lighting is installed within 1m of the receiver in an ordinary office.)

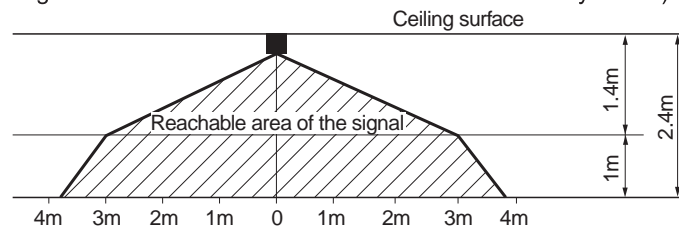

5 Receiver (continued)

2. Correlation between illuminance at the receiver and reachable area of the signal in a plain view. The drawing in the right shows the correlation between the reachable area of the signal and illuminance at the receiver when the wireless remote control is operated at 1.0m high under the condition of ceiling height of 2.4m. When the illuminance becomes double, the area is narrowed down to two thirds.

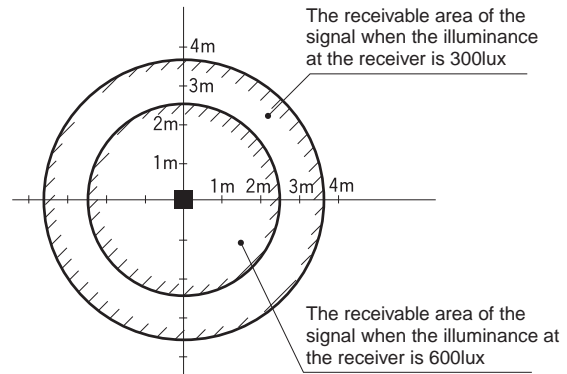

3. Installation tips when several receivers are installed close minimum distance between the indoor units which can avoid cross communication is 5m under the condition of 300lux of illuminance at the receiver. (When no lighting is installed within 1m of the receiver in an ordinary office)

Backup switch

A Backup switch is provided on the receiver. Even when the operation from the wireless remote control is not possible (due to flat batteries, control lost, or control failure), still it possible to operate as temporary means. Press the switch directly when operating it.

1. The air-conditioner starts the operation with the condition of auto mode, 23°C of set point, high fan speed and horizontal louver position.
2. The air-conditioner stops the operation when the switch is pressed when in operation.

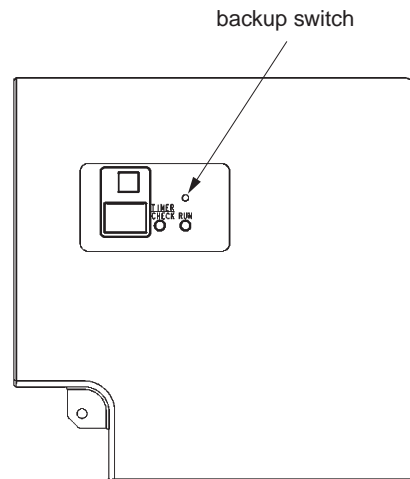

Cooling test run operation

- After safety confirmation, turn on the power.
- Transmit a cooling operation command with the wireless remote control unit, while the backup switch on the receiver is depressed.
- If the backup switch on the receiver is pressed during a test run, it will end the test run.
- If you cannot operate the unit properly during a test run, please check wiring by consulting with inspection guides.

How to read the 2-digit display

On the receiver of a wireless kit, a two-digit (7-segment) display is provided.

1. An indication will be displayed for one hour after power on.
2. An indication will be displayed for 3.5 seconds after transmitting a "STOP" command from the wireless remote control or the operation of the backup switch to stop the unit.
3. An indication appearing in (1) or (2) above will go off as soon as the unit starts operation.
4. When there are no error records to indicate, addresses of all the connected units are displayed.
5. When there are some error records remaining, the error records are displayed.
6. Error records can be cleared by transmitting a "STOP" command from the wireless remote control, while the backup button is pressed.